

PRELIMINARY

A29799 RML  
November 2007

# First InterComm™ System Installation Guide



**BAE SYSTEMS**

[www.Firstintercomm.com](http://www.Firstintercomm.com)

PRELIMINARY



PRELIMINARY

**A29799 RML**

**November 2007**

© 2007, BAE Systems Information and Electronic Systems Integration Inc.. All rights reserved

PRELIMINARY



## Table of Contents

<b>List of Illustrations .....</b>	<b>iii</b>
<b>List of Tables .....</b>	<b>iii</b>
<b>Document Change History .....</b>	<b>iii</b>
<b>Warnings and Precautions .....</b>	<b>iv</b>
<b>1.0 Introduction.....</b>	<b>1</b>
<b>2.0 First InterComm System™ Description.....</b>	<b>1</b>
2.1 Vehicle Communications Assembly, Model VCA100.....	3
2.2 VCA100 Power Connector .....	4
2.3 WiFi Antenna .....	4
2.4 Land Mobile Radio Antenna .....	4
<b>3.0 Planning the Installation .....</b>	<b>5</b>
3.1 Installation Kit Components.....	5
3.2 Tools and Test Equipment.....	6
3.3 System Component Locations.....	7
3.3.1 VCA100.....	7
3.3.2 WiFi Antenna.....	7
3.3.3 Land Mobile Radio Antenna .....	8
3.3.4 Power and Fuse .....	8
3.3.5 Manual Switch.....	8
<b>4.0 Installation Procedures .....</b>	<b>9</b>
4.1 VCA100 Unit.....	9
4.2 WiFi Antenna .....	9
4.3 Land Mobile Radio Antenna .....	10
4.4 DC Power .....	10
4.5 VCA100 On/Off Switch .....	11
4.6 Fuse Assembly .....	11
<b>5.0 Initial Power Test .....</b>	<b>12</b>
<b>6.0 Update User Specific Parameters .....</b>	<b>13</b>
6.1 Preparation.....	13
6.2 VCA100 Update Procedure .....	14
<b>7.0 Unit Test Plan.....</b>	<b>15</b>
7.1 LMR Antenna VSWR Test.....	15
7.2 System Functional Test .....	15
<b>8.0 Troubleshooting .....</b>	<b>16</b>
<b>9.0 BAE Support Information.....</b>	<b>16</b>
<b>10.0 Companion Documentation.....</b>	<b>16</b>
<b>Appendix A - Recommended LMR Antennas.....</b>	<b>17</b>

## Table of Contents (Cont.)

<b>Appendix - B VCA100 Software Programs and Utilities.....</b>	<b>18</b>
B.1 BAE Systems VCA Management Program.....	18
B.2 Serial IP Program .....	19
<b>Appendix C - Acronyms and Abbreviations.....</b>	<b>21</b>
<b>Appendix D - Troubleshooting Procedures .....</b>	<b>23</b>
<b>Appendix E - Installation Sign Off Sheet.....</b>	<b>24</b>

## List of Illustrations

1	Typical VCA100 Vehicle Installation .....	2
2	First InterComm VCA100 Unit .....	3
3	VCA100 Power Harness Connector – Front View .....	4
4	Standard Comtelco WiFi Antenna .....	4
5	In-Line Fuse.....	8
6	Mounting Bracket.....	9
B-1	FirstInterComm™ VCA Management Window .....	18
B-2	Serial IP Control Panel and Select Port Windows .....	19
B-3	Serial IP Program Configuration Wizard.....	20

## List of Tables

1	First InterComm VCA100 Models .....	3
2	VCA 100 Vehicle Installation Kit .....	5
3	Installer Supplied Parts.....	5
4	Required Test Equipment and Software .....	6
5	Recommended Tools for First InterComm Installation.....	6
6	Initial Power Tests .....	12
7	Required User Information .....	13
8	VCA100 Update Procedure .....	14
9	LMR Antenna VSWR Test Results .....	15
10	System Functional Test Results .....	15
A-1	Recommended LMR Antennas.....	17
A-2	LMR Antenna Specifications.....	17

## Document Change History

<b>DOCUMENT NO.:</b> A29799			
<b>TITLE:</b> First InterComm™ System Installation Guide			
DATE	REV.	PAGES AFFECTED	REMARKS
Nov 2007	---	---	Initial Publication

## Warnings and Precautions



### Federal Communications Commission (FCC)

**Compliance** - This equipment has been tested and found to comply with the limits for a Class B digital device, pursuant to Part 15 of the FCC Rules. These limits are designed to provide reasonable protection against harmful interference in a residential environment. This equipment generates, uses, and can radiate radio frequency energy and, if not installed and used in accordance with the instructions, may cause harmful interference to radio communications. Further, proper installation does not guarantee that interference will not occur in a particular situation. If this equipment does cause harmful interference to radio or television reception, which can be determined by turning the equipment off and on, the user is encouraged to try to correct the interference by one or more of the following measures:

- Reorient or relocate the receiving antenna.
- Increase the separation between the equipment and affected receiver.
- Connect equipment into an outlet on a circuit different from that to which the receiver is connected.
- Consult an experienced radio/TV technician for help.

**Radio Frequency Notice** – The First InterComm™ System generates and uses RF energy. Changes or modifications to the equipment may cause harmful interference unless the modifications are expressly approved in the installation or maintenance manuals. The authority to operate the equipment could be lost, if an unauthorized change or modification is made.



### Electromagnetic Interference/Compatibility

Nearly every electronic device is susceptible to electromagnetic interference (EMI) if inadequately designed, shielded, or otherwise configured for electromagnetic compatibility. It may be necessary to conduct compatibility testing to determine if any electronic equipment used in or around vehicles is sensitive to external RF energy or if any procedures need be applied to eliminate or mitigate the potential for interaction between the First InterComm™ System and other equipment or devices.

- **Facilities** – To avoid EMI or compatibility conflicts, turn off the First InterComm™ System near any facility where posted notices instruct you to do so; e.g., hospitals or health care facilities.
- **Vehicles** – To avoid possible interaction between First InterComm™ System and vehicle electronic control modules (e.g., ABS, engine, or transmission controls), the First InterComm system should be installed only by a professional installer.
- **Pacemakers** – Maintain a minimum separation of 12 inches between First InterComm™ System components (the VCA100 and associated antennas) and any pacemaker to avoid potential interference with pacemaker function.



### RF Exposure Compliance

Pursuant to FCC rules for the Maximum Permissible Exposure (RF) The antenna(s) specified in this manual MUST be installed so as to provide a separation distance of at least 18 inches (45 cm) from all persons.

In addition, the unit may not be used to transmit for more than 50% of the time (average duty cycle over a 30 minute period).



## EMC Installation Guidelines

The design and manufacture of the VCA100 conforms to the appropriate Electromagnetic Compatibility (EMC) standards, but correct installation is required to ensure that performance is not compromised. Although every effort has been taken to ensure that it will perform under all conditions, it is important to understand what factors could affect the operation of the product.

The guidelines given here describe the conditions for optimum EMC performance, but it is recognized that it may not be possible to meet all of these conditions in all situations. To ensure the best possible conditions for EMC performance within the constraints imposed by any vehicle, always ensure the maximum separation possible between different items of electrical equipment.

For **optimum** EMC performance, it is recommended that **wherever possible**:

The equipment and cables connected to it are:

- At least 3 ft. (1 m) from any equipment transmitting or cables carrying radio signals
- The cables specified in this manual are used. Cutting and rejoining these cables can compromise EMC performance and must be avoided.
- If a suppression ferrite is attached to a cable, this ferrite should not be removed.
- If the ferrite needs to be removed during installation it must be reassembled in the same position.

<b>WARNING</b>	General Precautions
----------------	---------------------

- **DC Power** – Ensure that power into the First InterComm™ System does not exceed 24VDC.
- **Explosive Environments** – Ensure the First InterComm™ System is turned off before entering a blasting area, or in areas posted “TURN OFF TWO-WAY RADIO”. Sparks in a potentially explosive atmosphere can cause an explosion or fire resulting in bodily injury or death.



## 1.0 [Introduction](#)

The First InterComm™ System (FICS) allows first responders from different agencies at an emergency incident to readily communicate with one another, even though their radios operate on different frequencies; i.e., VHF, UHF or 800 MHz systems, both digital and analog. The FICS can accommodate any new communication technologies, including the 700-MHz bandwidth.

Only one vehicle from each on-scene department is required to have an installed FICS unit to enable linking dissimilar radio networks. There is no requirement for special equipment, stand-alone towers, or other costly infrastructure.

An optional capability included with the FICS is the Incident Commander Talkgroup Control™ Software (ICTCS) that allows the Incident Commander (IC), using a standard laptop computer with Wireless Fidelity (Wi-Fi) capability, to monitor system status and to control communications. The ICTCS significantly enhances the system, but is *not required* for voice interoperability; the latter is provided by the VCA100 and associated antennas alone.

The Department of Homeland Security (DHS) has designated the FICS as a Qualified Anti-Terrorism Technology under the SAFETY Act. The FICS Supports the National Incident Management System (NIMS), and is included in the Memorial Institute for the Prevention of Terrorism (MIPT) “Responder Knowledge Base” and the InterAgency Board's (IAB) “Standard Equipment List” (SEL).

Finally, it is important to note that using the FICS does not require changes to your Standard Operating Procedures (SOP). Rather, it provides day-to-day voice interoperability at an incident scene, and offers improved coordination of on-site first responder personnel.

This installation guide contains information for the proper installation of the FICS. We strongly recommended that the system be installed in accordance with this guide, understanding that concessions may be needed for specific vehicles. This guide assumes that the system installer is a qualified professional, familiar with the intended vehicle, and possesses the proper tools.

## 2.0 [First InterComm System™ Description](#)

The FICS (Figure 1) consists of:

- VCA100 unit, matched to user's existing radio network frequencies
- Vehicle-mounted Wireless Fidelity (Wi-Fi) antenna
- Land Mobile Radio (LMR) antenna, matched to user's existing radio network frequencies
- Remote On/Off switch
- Incident Commander Talkgroup Control Software (optional capability)

The system operates on 12VDC vehicle power through an independent cab-mounted switch. There are no speakers, microphones, or other vehicle tie-ins.

Nine VCA100 models are available to cover the LMR bands (see Table 1). The LMR antenna must match the frequency band of the VCA100 model being installed. A standard, roof mounted 2.4 GHz 802.11 antenna is used for all VCA100 models.

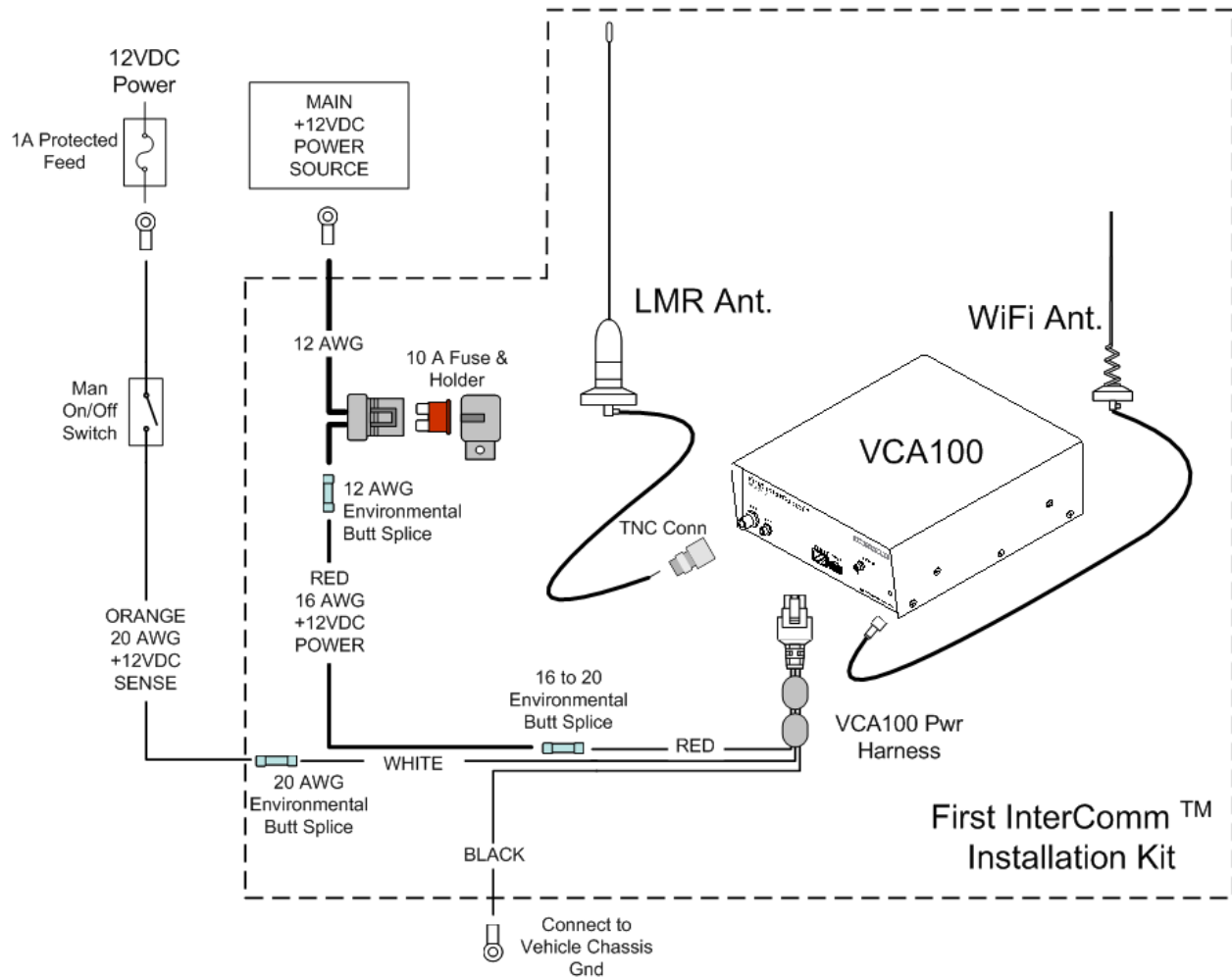

**Figure 1. Typical VCA100 Vehicle Installation**

**Table 1. First InterComm VCA100 Models**

Model	Protocol	Encryption	LMR Band	Frequency Range
VCA100-L1FCGX	FM	None	VHF Low Band	29.7 – 37 MHz
VCA100-L2FCGX	FM	None	VHF Low band	35 – 50 MHz
VCA100-V1FCGX	FM	None	VHF High Band	136 - 174 MHz
VCA100-V1PCGX	FM/P25	None	VHF High Band	136 - 174 MHz
VCA100-V1PAGX	FM/P25	DES/AES	VHF High Band	136 - 174 MHz
VCA100-V1PDGX	FM/P25	DES	VHF High Band	136 - 174 MHz
VCA100-U1FCGX	FM	None	UHF	450 - 520 MHz
VCA100-81FCGX	FM	None	800	806 - 870 MHz
VCA100-81PCGX	FM/P25	None	800	806 - 870 MHz
VCA100-81PDGX	FM/P25	DES	800	806 - 870 MHz
VCA100-91FCGX	FM	None	900	896 - 941 MHz

### 2.1 Vehicle Communications Assembly, Model VCA100

The VCA100 (Figure 2) is mounted in a vehicle and has no operator controls other than a remote power-on switch. Once initialized, VCA100 operations are transparent to the operator. Responders need only set their radio equipment to the pre-designated interoperability channel to monitor or speak to members of other radio networks at the site. The specific VCA100 model is selected based on the radio frequencies used by the participating department (see Appendix A).

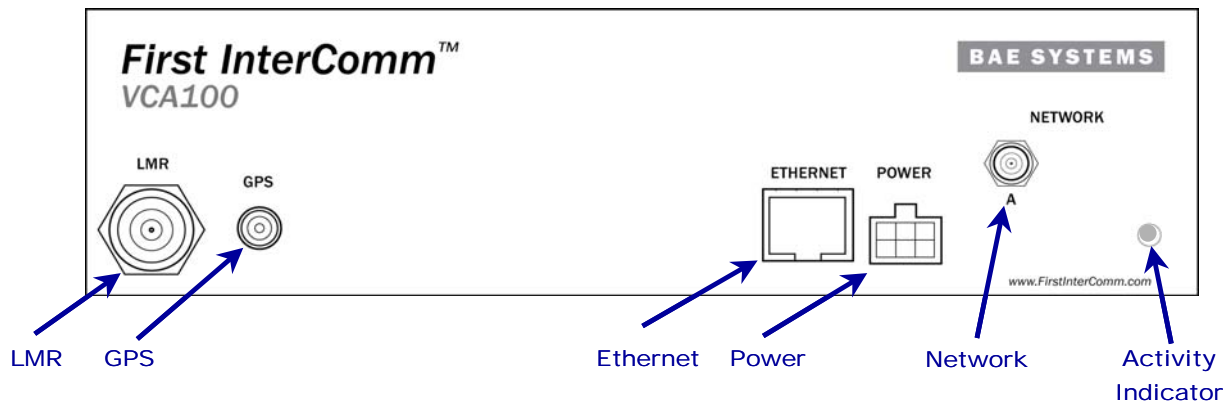

- **LMR:** 2-way radio antenna connection, TNC.
- **GPS:** Reserved for future implementation.
- **Ethernet:** Factory use only.
- **Power:** The VCA100 is permanently mounted in a First Responder vehicle. On/off is a cab-mounted toggle switch.
- **Network:** Wireless antenna port A, reverse polarity SMA connector.
- **Activity Indicator:** Indicator light that is on during boot up.

**Figure 2. First InterComm VCA100 Unit**

## 2.2 VCA100 Power Connector

The VCA100 uses three pins of a 6-pin Molex connector as shown in Figure 3.

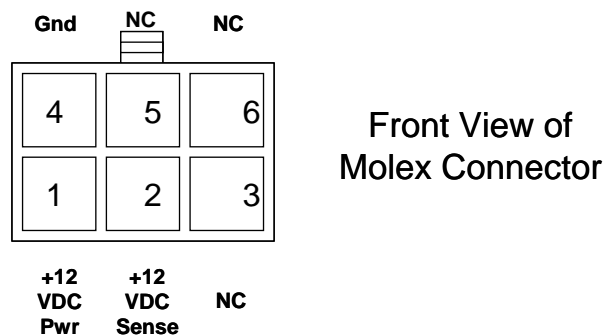

**Figure 3. VCA100 Power Harness Connector – Front View**

## 2.3 WiFi Antenna

The standard WiFi antenna for all VCA100 installations is the Comtelco Model A10245B (Figure 4), a 2.4 GHz 802.11 roof mounted antenna, with elevated feed to rise above cab obstructions and light bars.

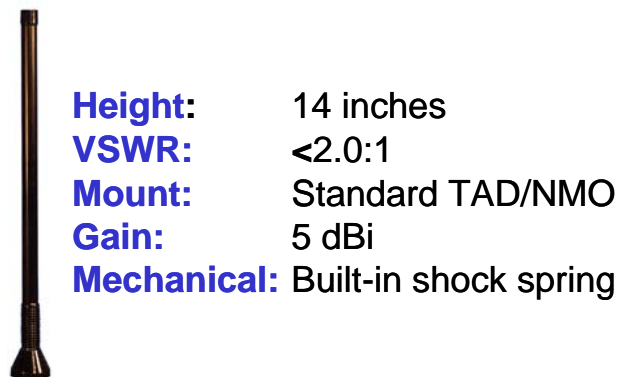

**Figure 4. Standard Comtelco WiFi Antenna**

## 2.4 Land Mobile Radio Antenna

An LMR antenna must match the frequency of the specific VCA100 model being installed on the vehicle. Appendix A lists recommended LMR antennas that may be used with various VCA100 models.

### 3.0 [Planning the Installation](#)

#### 3.1 Installation Kit Components

Table 2 lists the deliverable installation kit for the First InterComm system. Specific antennas will vary depending on the LMR frequency. The material listed is based on availability; equivalent products may be used.

Table 3 lists typical Installer-supplied parts that are vehicle specific and not supplied with the kit.

**Table 2. VCA 100 Vehicle Installation Kit**

Description	Part Number	Vendor	Qty
VCA100 Power Harness	8422765-2	Scott Electronics	1
Screws, center sunk head, #6-32 x .500 lg	91802A148	McMaster-Carr	4
12 VDC Power Cable, 16 AWG (red) for Specification SAEJ1128	WX16-2 (SXL 16 ga)	Waytek, Inc	20'
12 VDC Power Cable, 20 AWG (orange) for Specification SAEJ1128-GPT	WG20-3 (GPT 20 ga)	Waytek, Inc	15'
Butt Splice, 16 ga Environmentally Sealed	31980	Waytek, Inc	2
Butt Splice, Step Down, 16ga to 20 ga, environmentally sealed	38058	Waytek, Inc	1
Butt Splice, 20 ga Environmentally Sealed	30980	Waytek, Inc	2
ATO/ATC Fuse Holder with GXL wire	46047	Waytek, Inc	1
ATO/ATC Fuse, 10 A	46210	Waytek, Inc	1
LMR Antenna, through mount, with hardware	Various	Multiple	1
WiFi Antenna, elevated feed, 5dBi gain, 2.4GHz, through mount, 3/4-inch hole	A10245B	Comtelco	1
WiFi Through mount base w/ 12' cable and reverse polarity SMA connector	CEZM10-RP	Comtelco	1

**Table 3. Installer Supplied Parts**

Description	Part Number	Vendor	Quantity
SPST Switch, illuminating, 1 A (minimum)	44206 or similar	Waytek, Inc	1
Ground Wire, 18 AWG (black)	Varies	Tessco	As Required
Ring Terminal, size as needed (Gnd)	Varies	Panduit	2
Terminals, size as needed (switch)	Varies	Panduit	3
Terminal, size as needed (main power cut in)	Varies	Panduit	1
Grommet, rubber, various sizes	Varies	Waytek, Inc	As Required
Cable Ties, Nylon	PLT1.5I-C20	Panduit	As Required
Cable Tie mount, 4-way	ABMM-AT-C0	Panduit	As Required
Screws, self tapping, #8-32, .500 lg	98273A225	McMaster-Carr	9
Washers, size as needed	Varies	McMaster-Carr	3

### 3.2 Tools and Test Equipment

Table 4 lists details of the test equipment and software required to install the FICS. These comprise:

- A laptop computer equipped with WiFi capability, loaded with Windows® XP<sup>1</sup> Operating System, Service Pack 2, and FICS installer software (required to upload user-specific parameters into the VCA100). The laptop is also used to test the FICS after installation.
- A watt meter to test any antenna cables terminated by the installer.
- A volt/ohmmeter to perform voltage and resistance checks.

Table 5 lists recommended tools for the First InterComm installation. Equivalent substitutes may be used as necessary.

**Table 4. Required Test Equipment and Software**

Description	Part Number	Vendor	Quantity
Laptop PC with Windows XP, Service Pack 2	Varies	Varies	1
Buffalo 2.4 GHz Wireless Network Card	WLI-CB-G54HP	Buffalo Technology	1
BAE Systems First InterComm Installer's CD	TBD	BAE Systems	1
Voltage/Resistance Meter (DVM or VOM)	Varies	Varies	1
Watt Meter w/ cables and adapters	Varies	Varies	1

**Table 5. Recommended Tools for First InterComm Installation**

Tool	Model/Specification
Screwdrivers, Phillips Head	#1 and #2
Non-insulated Crimp Tool	Thomas & Betts WT-111-M
Crimp Tool, Ratcheting Coaxial	Cambridge 24-9960P
Hole Saw, 3/4-inch with depth protection	Ripley HSK 19 or Antenex® HS34
Non-Metallic Fish Tape	Klein-Lite® 50156, 25 feet
Clutch-type Screw Gun	Makita® #6096DWE, #1 and #2 Phillips-Head bits
Pliers	Slip Jaw
Electric Drill	3/8-inch, with HSS bits
De-Burring Tool	
Socket Set	Quarter Inch
Wire Cutters	Flush-cut and large
RF Cable Termination Kit	For SMA and TNC connectors
Heat Gun	

---

<sup>1</sup> Windows is a registered trademark of Microsoft Corporation



### 3.3 System Component Locations

#### WARNING

WHEN SELECTING LOCATIONS FOR FIRST INTERCOMM COMPONENTS, AVOID HIGH FREQUENCY (HF) NOISE PRODUCERS AND DO NOT RUN DC POWER FEEDS TO THE VCA100 PARALLEL TO IGNITION CIRCUITS, ELECTRONIC MODULES, OR SIMILAR ITEMS. AVOID RUNNING POWER LEADS IN PARALLEL WITH VEHICLE WIRING OVER LONG DISTANCES.

#### 3.3.1 [VCA100](#)

The VCA100 has no operator interfaces other than an activity indicator. Also, the unit has no fan; it is convection cooled and does not require any special ventilation. However, it is not environmentally sealed and must be installed in a protected area (THE ENGINE COMPARTMENT IS **NOT** ACCEPTABLE). The optimum location is one in which the VCA100 is out of the way, its face plate and cable connections protected as much as possible, and there are at least six inches of space around the VCA100 to allow air circulation.

Plan for cable management and strain relief loops for the cables. Cable ties and mounts are needed to prevent cable movement and vibration.

#### 3.3.2 [WiFi Antenna](#)

The WiFi antenna location has highest priority because the antenna's relatively short range has the greatest effect on system performance. Mount the antenna as high as possible on the cab roof, and as close as possible to the vehicle's centerline to provide 360-degree coverage. The antenna requires a metal ground plane to achieve its full 5dBi of gain.

We recommend keeping the antenna at least 12 inches away from any light bars or other antennas and **MUST** be installed so as to provide a separation distance of at least 18 inches (45 cm) from all persons. The maximum designed distance from the VCA100 to the WiFi antenna is 17 feet, the standard cable length that comes with the antenna. Extensions may be added to the cable, but this will reduce the WiFi range.

Certain vehicles do not allow locating the antenna in the center or center-rear of the roof. In this case, the next best antenna location is on the direct center of the trunk lid. The mounting area under the antenna must be a flat, metallized ground plane. Be aware, however, that this location will degrade the WiFi range.

### [3.3.3 Land Mobile Radio Antenna](#)

The LMR antenna must match the frequency of the specific VCA100 model being installed on the vehicle. Ensure that the new LMR antenna is not installed in close proximity to any existing LMR antennas.

We recommend keeping the antenna at least 12 inches away from any light bars, antennas, or other roof-mounted equipment and **MUST** be installed so as to provide a separation distance of at least 18 inches (45 cm) from all persons.

### [3.3.4 Power and Fuse](#)

The vehicle's main power source is connected to the VCA100 by the DC power cable (red) that passes through an inline fuse. Locate the fuse as close as possible to the power source and splice it in with weatherproof butt splices (*SUPPLIED*). Mount the fuse assembly (Figure 5) to facilitate maintenance. Splice the power line to the VCA100 power harness (*SUPPLIED*) using the step-down splice (*SUPPLIED*) to accommodate the dissimilar wire gauges.



**Figure 5. In-Line Fuse**

### [3.3.5 Manual Switch](#)

A second, low current, power line (orange) must run through a cab-mounted manual toggle switch to the VCA100 *SENSE* input (pin 2). This switch is not supplied in the deliverable installation kit because User-specific vehicle installations vary; i.e., switch location is a function of User requirements and vehicle constraints. An illuminated manual switch, appropriately labeled, is recommended. Connect the switch to a 1-ampere fuse-protected vehicle power source.

## 4.0 [Installation Procedures](#)

### 4.1 VCA100 Unit

1. Record the VCA100 model number and serial number on the *INSTALLATION SIGN OFF SHEET* (see Appendix E).
2. Carefully inspect the area selected for the VCA100 unit to ensure that the area is free of physical or electrical obstacles that could interfere with proper installation, maintenance, or operation.
3. Attach the two L-shaped mounting brackets (Figure 6) to the sides of the VCA100 using four #6-32 countersunk machine screws (*SUPPLIED*). Attach the wide edge of the bracket to the VCA100; attach the narrow edge to the vehicle.
4. Place the VCA100 in its final location and scribe three bracket holes into the vehicle on each side of the VCA100 for drilling. Select slotted or single holes as necessary - the VCA100 must be firmly mounted to the vehicle.
5. Pre-drill six holes into the vehicle to accommodate self-tapping screws. The size of the hardware used determines the size of the holes.
6. Mount the VCA100 to the vehicle with self-tapping screws.

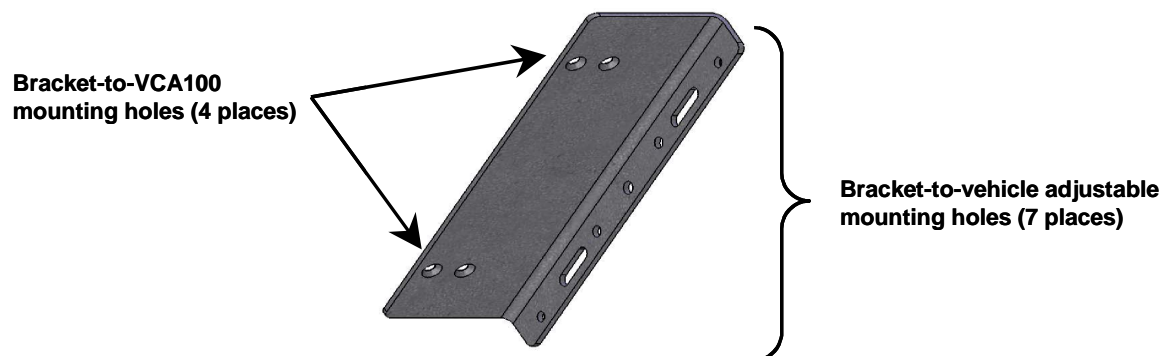

**Figure 6. Mounting Bracket**

### 4.2 WiFi Antenna

1. Verify the center pin of the WiFi antenna cable is female (reverse polarity SMA). Carefully inspect the area selected for the WiFi antenna to ensure that the area is free of physical or electrical obstacles that could interfere with proper installation, maintenance, or operation.
2. Follow manufacturer's installation instructions for external mounting of antenna.
3. Run the RF cable from the WiFi antenna to the VCA100. Use cable ties and mounts to protect the cable. Grommet all through holes to prevent cable chaffing.
4. At the VCA100, loosely coil up excess WiFi RF cable and lay in a stress relief loop if the cable cannot land with a straight in path to the VCA100 *NETWORK SMA* connector.

5. Connect the WiFi RF cable to the VCA100 *NETWORK A* SMA connector. Use cable ties and mounts to keep the cable from moving or placing stress on the SMA connector.

### 4.3 Land Mobile Radio Antenna

1. Carefully inspect the area selected for the LMR antenna to ensure that the area is free of physical or electrical obstacles that could interfere with proper installation, maintenance, or operation.
2. Follow the manufacturer's installation instructions for mounting of the antenna and for trimming it to the user's frequency.
3. Run the RF cable from the LMR antenna to the VCA100. Use cable ties and mounts to protect the cable. Grommet all through holes to prevent cable chaffing.
4. At the VCA100, lay in a stress relief loop and cut the LMR RF cable to length. Terminate the cable with a TNC connector in accordance with manufacturer's instructions.
5. Connect the LMR RF cable to *VCA100 LMR TNC* connector.

### 4.4 DC Power

1. Carefully inspect the area selected for the DC power lines to ensure that the area is free of physical or electrical obstacles that could interfere with proper installation, maintenance, or operation.
2. Starting at the VCA100, locate a suitable chassis ground as close to the VCA100 as possible. If necessary, scrape and remove paint to reach bare metal. Drill chassis and use a self-tapping screw to create a chassis ground.
3. Locate the 20 AWG ground (black) wire of the VCA100 power harness (Pin 4). Cut and strip the outer cable jacket as required. Cut the end of the ground wire to length, terminating with a ring terminal, and secure the terminal to the chassis ground created in Step 2 (see Figure 3).
4. Lay in a stress relief loop and use cable ties and mounts to secure the ferrite cores of the power harness to the vehicle and prevent vibration or strain on the power connector.
5. Connect a suitable length of red 16 AWG wire to the VCA100 power harness main power (red) wire (Pin 1) (see Figure 3) using the 16 to 20 step-down environmental splice (*SUPPLIED*). Run the other end of the wire to the VCA100 in-line fuse. Use cable ties and mounts to protect the cable. Grommet all through holes to prevent cable chaffing.
6. Connect a suitable length of orange 20 AWG wire to the VCA100 power harness 12V Sense (white) wire (Pin 2) (see Figure 3) using the 20 AWG environmental splice (*SUPPLIED*). Run the other end of the wire to the planned location of the VCA100 On/Off Switch. Use cable ties and mounts to protect the wire. Grommet all through holes to prevent cable chaffing.

#### 4.5 VCA100 On/Off Switch

1. Carefully inspect the area selected for the VCA100 On/Off Switch to ensure that the area is free of physical or electrical obstacles that could interfere with proper installation, maintenance, or operation.
2. Drill or cut an area to hold the lighted toggle switch. Mount and label the switch.
3. Locate a suitable chassis ground as close to the new power switch as possible. If necessary, scrape and remove paint to reach bare metal. Drill chassis and use self-tapping screw to create a chassis ground.
4. Connect a suitable length of black 20 AWG wire to the ground lug of the VCA100 power switch using an appropriate terminal. Cut other end to length, terminate with a ring terminal, and secure the assembly to the chassis ground.
5. Locate the end of the orange 20 AWG sense wire from the VCA100 power connector and cut it to length to mate with the On/Off switch. Connect the wire to the power out lug of the VCA100 power switch using an appropriate terminal.
6. Use an appropriate terminal to connect a suitable length of orange 20 AWG wire to the power in lug of the VCA100 power switch. Connect the other end of the wire to a 1A fuse-protected vehicle power source with appropriate terminal. Use cable ties and mounts to protect the wire. Grommet through holes to prevent cable chaffing.
7. Reassemble any panels or consoles opened for installation of the switch.

#### 4.6 Fuse Assembly

1. Carefully inspect the area selected for the fuse assembly to ensure that the area is free of physical or electrical obstacles that could interfere with proper installation, maintenance, or operation.
2. Drill into the vehicle at the proper location to receive the Fuse Assembly's cap and mounting tab. Remove fuse from holder and mount holder using a self-tapping screw.
3. Locate the end of the red 16 AWG wire from the VCA100 Power harness and cut it to length to mate with one end of the Fuse Assembly. Connect it to the Fuse Assembly using a 12AWG environmental splice (*SUPPLIED*).
4. If the Fuse Assembly lead is too short, use an environmental splice (*SUPPLIED*) connected to a suitable length of red 16AWG wire to extend the lead.
5. Connect the Fuse Assembly's other wire to the vehicle's load center or main +12VDC power source using the appropriate termination.
6. Use cable ties and mounts to protect the wire. Grommet all through holes to prevent cable chaffing. Install VCA100 Fuse.

## 5.0 Initial Power Test

1. Before connecting to the VCA100, use a voltmeter at the VCA100 power harness connector to check for a constant +12VDC, switched +12VDC, and ground (Figure 3 shows the VCA100 power connector).
2. Follow the steps as listed in Table 6. Correct any problems encountered before proceeding to the next step.

**Table 6. Initial Power Tests**

Step	Procedure	Expected Result	Verified
<div style="display: flex; align-items: center; justify-content: center;"> <div style="text-align: center;"> <p>Front View of Molex Connector</p> </div> <div style="margin-left: 20px;"> <p><b>Required Equipment:</b> Volt/Ohm Meter</p> </div> </div>			
1	Verify VCA100 power harness is disconnected from VCA100 and energized	VCA100 power harness disconnected and energized	
2	Probe the VCA100 power harness connector Pin 1 for a constant +12 VDC	Voltmeter reads vehicle power as approximately +12VDC	
3	Set the VCA100 power switch to ON	Power switch is ON	
4	Probe the VCA100 power harness connector pin 2 for switched +12 VDC (sense)	Voltmeter reads vehicle power as approximately +12VDC	
5	Set the VCA100 power switch to OFF	VCA100 is OFF	
6	Probe the VCA100 power harness connector pin 2 for switched +12 VDC (sense)	Voltmeter reads 0 VDC	
7	Probe VCA100 power harness connector pin 4 (ground) to chassis ground with ohmmeter	Good ground connection exists	
8	Connect VCA100 power harness to VCA100.	Items are connected.	
9	Turn on VCA100 unit and monitor Activity LED.	Activity LED lights up during boot up.	

## 6.0 Update User Specific Parameters

The VCA100 is delivered with factory-installed default parameters. After vehicle installation, the unit must be updated with user-specific parameters. This programming is done using BAE Systems' supplied *VCA MANAGEMENT PROGRAM* and utilities loaded on a maintenance laptop equipped with a Buffalo Technology WLI-CB-G54HP wireless network card.

### 6.1 Preparation

1. Appendix B contains instructions for operating the *Serial IP* and the *VCA MANAGEMENT PROGRAM*.
2. Record the required VCA100 User information in Table 7. This information will be broadcast on the WiFi network.

**Table 7. Required User Information**

Item	Parameter	Format	User Data
1	Department Name	Up to 128 Characters.	
2	Vehicle ID	Up to 128 Characters.	
3	Vehicle Type	Icon on WiFi network pulldown menu; e.g., fire, police, ambulance.	
4	Nickname	Up to 16 Characters	
5	Bandwidth	Wide (25 kHz) or Narrow (12.5 kHz)	
6	Mode	Analog or Digital, pulldown menu	
7	Transmit Power	High or Low, pulldown menu	
8	Transmit Frequency	Numeric entry in MHz	
9	Receive Frequency	Numeric entry in MHz	
10	Transmit Private Line Code	Frequency or Alphanumeric [e.g. 94.8Hz (2A)], Pulldown menu	
11	Receive Private Line Code	Frequency or Alphanumeric [e.g. 94.8Hz (2A)], Pulldown menu	
12	VCA100 ID	Serial number on unit	

## 6.2 VCA100 Update Procedure

1. Appendix B contains instructions for operating the *Serial IP* and the *VCA MANAGEMENT PROGRAM*.
3. Follow the steps as listed in Table 8. Correct any problems encountered before proceeding to the next step.

**Table 8. VCA100 Update Procedure**

<b>Required Items:</b>			
a. VCA100 Installed in vehicle			
b. User Parameters (Table 7 of this document).			
c. Installer's WiFi Laptop configured using BAE Systems' Installation CD			
<b>Step</b>	<b>Procedure</b>	<b>Expected Result</b>	<b>Verified</b>
1	Turn on VCA100. Wait one minute for boot up to complete.	Booted	
2	Turn on the laptop and connect to First_InterComm_Network	Connected	
3	Execute <i>VCA MANAGEMENT PROGRAM</i> (see Appendix B in this document) and input specific User Parameters.	Updated	
4	Close <i>VCA MANAGEMENT PROGRAM</i> and launch <i>Serial IP</i> program (see Appendix B in this document)	Running	
5	Program VCA100 RF module with specific User LMR frequencies and PL Codes.	Programmed	



## 7.0 Unit Test Plan

Follow the test procedures described in Paragraphs 7.1 and 7.2. Correct any problems found, retest, and record final results on the *INSTALLATION SIGN OFF SHEET* (Appendix E).

### 7.1 LMR Antenna VSWR Test

Perform an antenna VSWR test using the antenna manufacture's procedure or a standard industry accepted procedure. Record results in Table 9.

**Note**  
THIS TEST IS NOT REQUIRED IF THE ANTENNA WAS TERMINATED BY THE OEM AND HAS NOT BEEN MODIFIED.

**Table 9. LMR Antenna VSWR Test Results**

<b>Required Material:</b>			
a. VCA100 installed in vehicle with LMR Antenna and cable under test			
b. Antenna OEM's VSWR procedure (or standard industry accepted VSWR procedure)			
c. Watt meter			
Step	Procedure	Requirement	Result
1	Perform selected VSWR procedure. Record result.	< 2:1 VSWR	

### 7.2 System Functional Test

1. Follow the test steps in Table 10 to verify the VCA100's key functions and its ability to operate in a network.
2. Correct any problems found, retest, and record final results on the *INSTALLATION SIGN OFF SHEET* (Appendix E).

**Table 10. System Functional Test Results**

<b>Required Material:</b>			
a. VCA100 under test installed in vehicle and configured with user parameters			
b. Known good user LMR with the same Frequency and PL Code as the VCA100 under test			
c. Known good second VCA100 and LMR set to a different frequency than the VCA100 under test			
Step	Procedure	Expected Result	Verified
1	Turn on VCA100 under test. Wait one minute for boot up to complete.	Boot up complete	
2	Turn on LMR associated with the VCA100 under test. Verify the proper channel is selected.	Proper channel selected	
3	Turn on known good second VCA100. Wait one minute for boot up to complete.	Boot up complete	
4	Turn on LMR associated with known good VCA100. Verify proper channel is selected.	Proper channel selected	
5	Verify 2-way communication through both units occurs without distortion, breakup, or dropouts. Record final result on <i>Installation Sign Off Sheet</i> .	Communication is good	

## 8.0 [Troubleshooting](#)

Appendix D contains detailed troubleshooting procedures for the FICS.

### IMPORTANT

- If the FICS appears to interfere with incident site operations, immediately turn off every VCA unit (and ICTCS if in use), and return to normal SOP.
- If ICTCS or laptop computer problems occur, the VCA100 units will remain in their assigned Talkgroups. If the laptop or ICTCS is not functional, and communications is needed between all responders, power-cycle all VCA100s.

## 9.0 [BAE Support Information](#)

- Telephone Support: (603) 759-1027
- E-Mail: [firstintercomm.eis@baesystems.com](mailto:firstintercomm.eis@baesystems.com)
- Web: <http://www.Firstintercomm.com>

## 10.0 [Companion Documentation](#)

- *First InterComm™ System User Guide*, Document No. A29798, November 2007.
- *First InterComm™ System Incident Commander Talkgroup Control Software*, Document No. A29800, October 2007.

## Appendix A Recommended LMR Antennas

**Table A-1. Recommended LMR Antennas**

Model	Suggested Antennas	LMR Band	Frequency Range	Protocol	Encryption
VCA100-L1FCGX	C27, C30, C34	VHF Low Band	29.7 – 37 MHz	FM	None
VCA100-L2FCGX	C34, C37, C40, C47	VHF Low band	35 – 50 MHz	FM	None
VCA100-V1FCGX	B1323	VHF High Band	136 - 174 MHz	FM	None
VCA100-V1PCGX	B1323	VHF High Band	136 - 174 MHz	FM/P25	None
VCA100-V1PAGX	B1323	VHF High Band	136 - 174 MHz	FM/P25	DES/AES
VCA100-V1PDGX	B1323	VHF High Band	136 - 174 MHz	FM/P25	DES
VCA100-U1FCGX	B4503, B4703, B4903	UHF	450 - 520 MHz	FM	None
VCA100-81FCGX	B8063	800	806 - 870 MHz	FM	None
VCA100-81PCGX	B8063	800	806 - 870 MHz	FM/P25	None
VCA100-81PDGX	B8063	800	806 - 870 MHz	FM/P25	DES
VCA100-91FCGX	B8963	900	896 - 941 MHz	FM	None

**Table A-2. LMR Antenna Specifications**

Manufacturer	Part Number	Frequency (MHz)	Gain (dBi)	Wave Length	Load	Tunable	Height (inches)
Laird	C27	26.75-31	Unity	1/4	Coil Style	Yes	52.5
Laird	C30	30-35	Unity	1/4	Coil Style	Yes	52.5
Laird	C34	34-37	Unity	1/4	Coil Style	Yes	52.5
Laird	C37	37-40	Unity	1/4	Coil Style	Yes	52.5
Laird	C40	40-47	Unity	1/4	Coil Style	Yes	52.5
Laird	C47	47-50	Unity	1/4	Coil Style	Yes	52.5
Laird	B1323	132-174	3	5/8	Coil Style	Yes	57
Laird	B4503	450-470	3	5/8	Coil Style	Yes	13
Laird	B4703	470-490	3	5/8	Coil Style	Yes	12.5
Laird	B4903	490-512	3	5/8	Coil Style	Yes	12.5
Laird	B8063	806-866	3	5/8	Base	Yes	4 7/8
Laird	B8963	896-970	3	5/8	Base	-	4 7/8

## Appendix B VCA100 Software Programs and Utilities

### B.1 BAE Systems VCA Management Program

The *VCA Management Program* is used to connect wirelessly to the VCA100 in order to change User parameters and upgrade software on the VCA100. The procedure is to:

1. Launch the *BAE Systems VCA Management Program* software using the Windows start button to navigate to and click on the *TBD* icon.
2. Enter password in the pop up window and click *Validate*.
3. Select the VCA100 to be updated by clicking on it in the *VISIBLE UNITS* pane of the *VCA Management* window (Figure B-1)
4. Fill in the fields with new parameter information. Click on *Commit* to update.
5. If the VCA100 software requires upgrading, click on *Browse* and navigate to the location of the new software file.
6. Click on the filename to enable the *Update* button. The field next to the button will display the filename.
7. Click on *Update* and monitor the *UPGRADE STATUS* bar for progress.
8. Perform the *SYSTEM FUNCTIONAL TEST* described in Paragraph 7.2 to verify that the newly programmed VCA100 communicates with other VCA100 units.

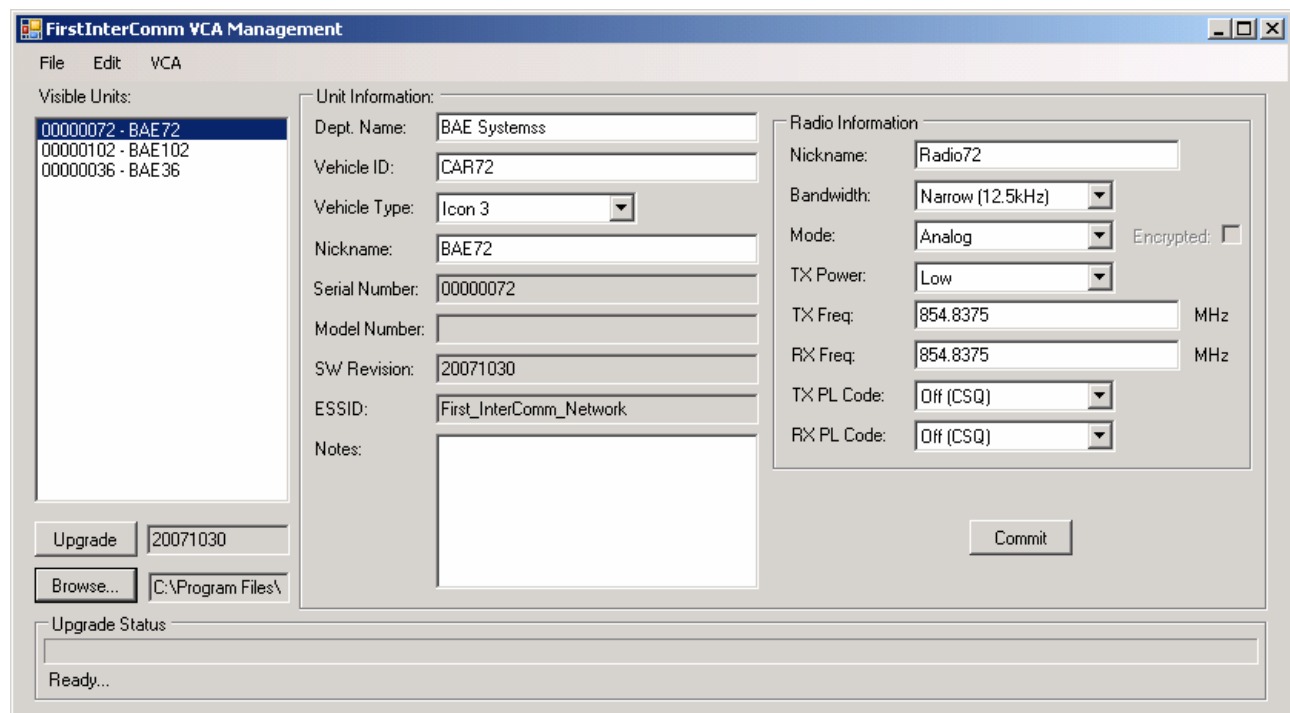

Figure B-1. FirstInterComm™ VCA Management Window

## B.2 Serial IP Program

*Serial IP*, a utility program, creates a virtual COM port that associates an IP address with a hardware COM port. This allows RS-232 programming over a wireless link to the VCA100 RF Module. The procedure is to:

1. Start the *VCA MANAGEMENT PROGRAM* (Paragraph B.1) to enable access to the VCA100.
2. Start the Serial IP Panel (Figure B-2) using the Windows start button; i.e.,  
*START → ALL PROGRAMS → SERIAL IP → CONTROL PANEL*
3. Enter the unit's IP address into the *IP ADDRESS BOX (10.0.0.X)*, where X is the last digits of the unit's serial number. Enter 7000 into the *Port Number* box.
4. Set the COM port to COM2 in the Serial IP Control Panel;  
*SELECT PORTS... → COM2 → OK*
5. Click on the *Configuration Wizard* (Figure B-3) in the *SERIAL IP CONTROL PANEL*.
6. Click *Start* in the wizard.
7. Watch the *STATUS* window in the *Configuration Wizard* to verify that the *TELENET* session progresses successfully and that all check marks are green.
8. Click on *Use Settings* in the *CONFIGURATION WIZARD* to complete the Serial IP setup and enable the virtual Com Port.

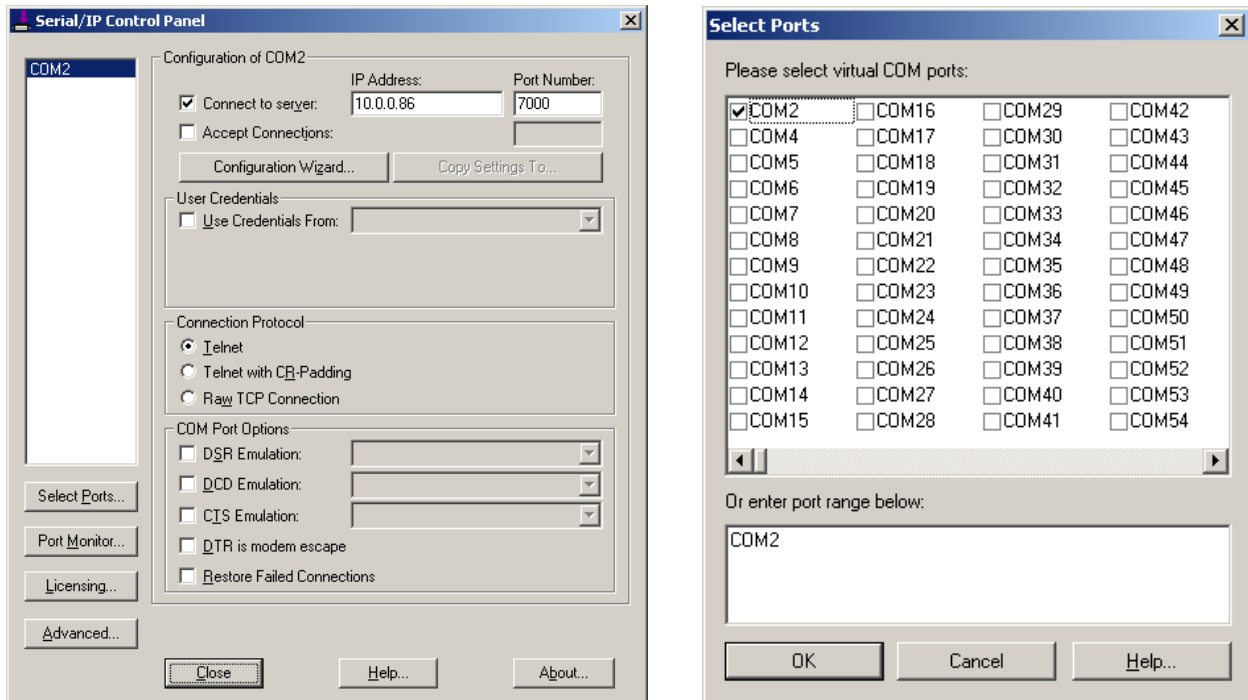

Figure B-2. Serial IP Control Panel and Select Port Windows

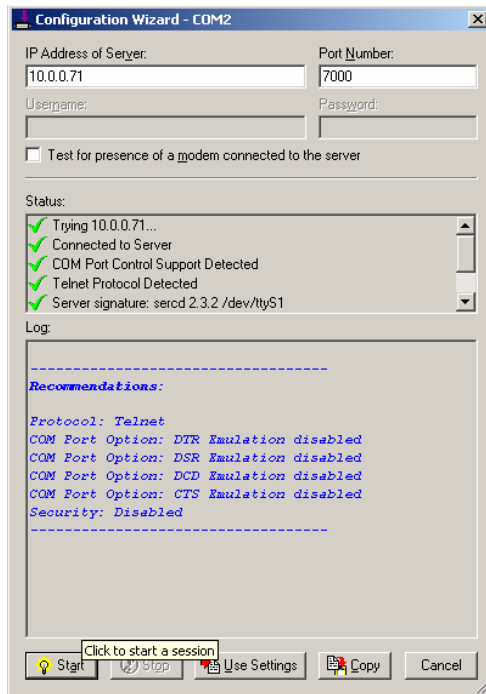

Figure B-3. Serial IP Program Configuration Wizard

## Appendix C

### Acronyms and Abbreviations

ABS	Antilock Brake System
AES	Advanced Encryption Standard
ATC	Automotive Blade-Type Fuse
ATO	Automotive Blade-Type Fuse
AWG	American Wire Gauge
COM	Communication (port)
DC	Direct Current
DES	Data Encryption Standard
DHS	Department of Homeland Security
EMI	Electromagnetic Interference
EMS	Emergency Medical Service
FCC	Federal Communications Commission
FICS	First InterComm™ System
FM	Frequency Modulation
GPS	Global Positioning System
GXL	Brand name for a cross-linked polyethylene jacketed wire
HF	High Frequency
HSS	High Speed Steel
IAB	InterAgency Board
IAN	Incident Area Network
IC	Incident Commander
ICTCS	Incident Command Talkgroup Control Software
ID	Identification
IP	Internet Protocol
LED	Light Emitting Diode
LMR	Land Mobile Radio
MIPT	Memorial Institute for the Prevention of Terrorism
NIMS	National Incident Management System
NMO	New Motorola
OEM	Original Equipment Manufacturer
P25	Project 25 (digital encryption protocol)
RF	Radio Frequency
SAE	Society of Automotive Engineers
SEL	Standardized Equipment List
SMA	Subminiature A-type (connector)
SOP	Standard Operating Procedures
SPST	Single Pole, Single Throw
TBD	To Be Determined
TNC	Threaded Neill-Concelman (connector)
UHF	Ultra High Frequency
VCA	Vehicle Communications Assembly
VHF	Very High Frequency
VSWR	Voltage Standing Wave Ratio

WiFi      Wireless Fidelity



Appendix D  
Troubleshooting Procedures  
To Be Supplied

## Appendix E Installation Sign Off Sheet

**I CERTIFY THAT THE FIRST INTERCOMM SYSTEM SUPPLIES AND INSTALLATION SERVICES HAVE BEEN FURNISHED IN ACCORDANCE WITH APPLICABLE CONTRACT REQUIREMENTS.**

Site Name: \_\_\_\_\_

Site Location: \_\_\_\_\_

Vehicle VIN: \_\_\_\_\_

Vehicle Type / Model: \_\_\_\_\_

VCA100 S/N: \_\_\_\_\_

The undersigned agree that the Unit Test Plan has been satisfactorily completed, with the exception of the outstanding items identified below, which must be resolved per the list below in order for Customer to be fully satisfied.

\_\_\_\_\_  
Name, Title (BAE Systems Representative) Date \_\_\_\_\_

\_\_\_\_\_  
Name, Title (Customer) Date \_\_\_\_\_

### OUTSTANDING ISSUES

Test Para.	Issue	Resolution Plan	Resolution

THIS PAGE INTENTIONALLY LEFT BLANK

