

AUTO - SCANNING WITH DIGITAL CONTROL LCD COLOR MEDICAL MONITOR

AMM261WTD

Operation Manual

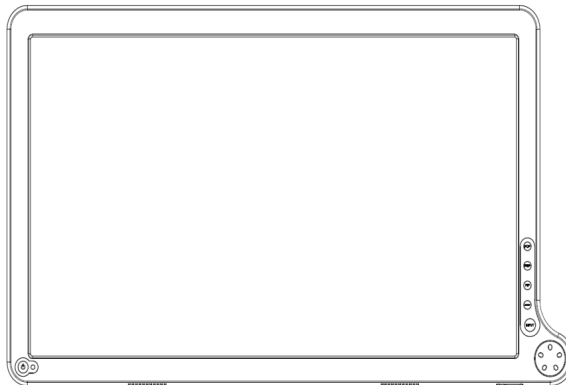

For future reference, record the serial number of your display monitor in the space below :

Serial Number

The serial number is located on the back of the monitor

back of the monitor

WARNING

The title «WARNING» is used to inform the users of possible causes that could inflict the injury, death, or property damage to the patients.
--

CAUTION

The title «CAUTION» is used to inform the users of possible causes that could inflict the patients although it might not severe enough to cause deaths.

NOTE

The title «NOTE» is used to inform the users of items that are of importance in terms of installation, operation, or maintenance of the Equipment although the failure does not inflict the bodily harm to the patients.
--

ADVAN INT'L CORP.2013

All other trademarks are the property of their reference owners.

This document is subject to change without notice.

Advan provides this information as reference only. Reference to other vendor's products does not imply any recommendation or endorsement.

Revision Control

Document number

Draft

TABLE OF CONTENTS

Product Description and Intended Use.....	3
Warnings and Cautions	4
Symbol Explanations	7
EU Declaration of Conformity for Medical Applications	8
Safety Precaution	9
Cleaning Your Monitor	9
Recommendation to Use more than One Unit.....	9
On Burn-in	9
Power Management Function.....	10
Preset Modes.....	11
Video Signals.....	12
PIP / POP / PBP function.....	13
DDC.....	14
Installation	14
Connecting the Power Cord	15
User Function / Messages.....	16
OSD Section.....	17
Troubleshooting.....	25
Specification of (AMM261WTD)	26
Classification	27
Electromagnetic Compatibility	28
Dimension Drawing (mm) of AC Adapter.....	30
Dimension Drawing (mm) of AMM261WTD.....	31
Connectors	32
Description of Warranty	33
Accessory Item List	37

Product Description and Intended Use

Please check the following items are present when you unpack the box, and save the packing materials in case you will need to ship or transport the monitor in future.

- AMM261WTD LCD Monitor(the equipment that displays information, graphic data, image and video on its LCD screen) and two video cables
(1) HD15 VGA cable (1) DVI-I cable



- AC Power cord*



- AC-Adapter



 CAUTION
Model No : BPM150S24F10

- Composite Video BNC Jack Cable, and Super Video Cable.



- User Manual, Quick Reference Guide and 4pcs VESA screws



*Might vary pending on region standard

Warnings and Cautions

Please read this manual and follow its instructions carefully. The words warning, caution, and note carry special meanings and should be carefully reviewed:



Warning The personal safety of the patient or physician may be involved. Disregarding this information could result in injury to the patient or physician.

Caution Special service procedures or precautions must be followed to avoid damaging the instrument.

Note Special information to make maintenance easier or important information more clear.



An exclamation mark within a triangle is intended to alert the user to the presence of important operating and maintenance instructions in the literature accompanying the product.



A lightning bolt within a triangle is intended to warn of the presence of hazardous voltage. Refer all service to authorized personnel.



Warning **TO AVOID POTENTIAL SERIOUS INJURY TO THE USER AND THE PATIENT AND/OR DAMAGE TO THIS DEVICE, THE USER MUST :**

Warranty is void if any of these warnings are disregarded.

ADVAN Int'l Corp accepts full responsibility for the effects on safety, reliability, and performance of the equipment only if:

- Re-adjustments, modifications, and/or repairs are carried out exclusively by ADVAN Int'l Corp.
- The electrical installation of the relevant operating room complies with the applicable IEC and CE requirements.

Warning **Federal law (United States of America) restricts this device to use by, or on order of a physician.**

The ADVAN Int'l Corp AMM261WTD monitor has been tested under UL 60601-1 standard and UL listed for Medical application.

ADVAN Int'l Corp reserves the right to make improvements in the product(s) described herein. Product(s), therefore, may not agree in detail to the published design or specifications. All specifications are subject to change without notice. Please contact ADVAN Int'l Corp directly or phone your local ADVAN Int'l Corp sales representative or agent for information on changes and new products.

Warnings

1. Read the operating manual thoroughly and be familiar with its contents prior to using this equipment.
2. Carefully unpack the unit and check if any damage occurred during shipment.
3. Should any solid object or liquid fall into the panel, unplug the unit and have it checked by qualified personnel before operating it any further.
4. Uplug the unit if it is not to be used for an extended period of time. To disconnect the cord, pull it out by the plug. Never pull the cord itself.
5. Be a qualified physician, having complete knowledge of the use of this equipment.
6. Test this equipment prior to a medical procedure. This monitor was fully tested at the factory before shipment.
7. Avoid removing covers on control unit to avoid electric shock.
8. Attempt no internal repairs or adjustments not specifically detailed in this operating manual.
9. Pay close attention to the care, cleaning instructions in this manual. A deviation may cause damage (refer to the Cleaning section).
10. DO NOT STERILIZE MONITOR.
11. Read the entire instruction manual before assembling or connecting the camera.
12. Do not place the monitor or any other heavy object on the power cord. Damage to the cable can cause fire or electric shock.
13. Monitor with power supply is suitable for use in patient environment.
14. DO NOT stack more than 3 boxes high

This equipment has been tested and found to comply with the limits for medical devices in IEC 60601-1-2:2003. These limits are designed to provide reasonable protection against harmful interference in a typical medical installation.

This equipment generates, uses and can radiate radio frequency energy and, if not installed and used in accordance with the instructions, may cause harmful interference to other devices in the vicinity. However, there is no guarantee that interference will not occur in a particular installation. If this equipment does cause harmful interference to other devices, which can be determined by turning the equipment off and on, the user is encouraged to try to correct the interference by one or more of the following measures:

- Reorient or relocate the receiving device.
- Increase the separation between the equipment.
- Connect the equipment into an outlet on a circuit different from that to which the other device(s) are connected.
- Consult the manufacturer or field service technician for help.

NOTICES TO USER

This device complies with Part 15 of the FCC Rules. Operation is subject to the following two conditions:

- (1) this device may not cause harmful interference, and
- (2) this device must accept any interference received, including interference that may cause undesired operation.

FCC WARNING

This equipment generates or uses radio frequency energy. Changes or modifications not expressly approved by the party responsible for compliance could void the user's authority to operate the equipment. The user could lose the authority to operate this equipment if an unauthorized change or modification is made.

Cautions

1. The AC Adapter must be plugged into a Grounded power outlet.
2. Use only the proprietary AMM261WTD power supply for the AMM261WTD monitor. Make a proper connection by ensuring that the shrink tubing completely secures the connection between the DC power cord and the extension cord.
3. Turn power off when unit is not in use.
4. Never operate the unit right after having transported from a cold location directly to a warm location.
5. Do not expose the monitor to moisture or directly apply liquid cleaners directly to the screen. Spray the cleaning solution into a soft cloth and clean gently.
6. Handle the monitor with care. Do not strike or scratch the screen.
7. Do not block the monitor cooling vents. The monitor is cooled by natural convection and has no fan.
8. Do not force the monitor past 28 degrees of vertical when adjusting the screen position. (For monitors equipped with stands only.)
9. Remove the power module and connection when transporting the unit.
10. Save the original carton and associated packing material. They will be useful should you have to transport or ship the unit.
11. Allow adequate air circulation to prevent internal heat buildup.
12. Do not place the unit on surfaces (rugs, blankets, etc.) or near materials (curtains, draperies) that may block the ventilation slots.
13. Do not install the unit near sunlight, excessive dust, mechanical vibration or shock.
14. The unit is designed for operation in a horizontal position. Never operate the unit in a vertical position.
15. Keep the unit away from equipment with strong magnets (i.e. a large loudspeaker.)
16. Do not expose the monitor to moisture or excessive dust.
17. Equipment with SIP/SOP connectors should either comply with IEC 60601-1 and/or IEC 60601-1-1 harmonized national standard or the combination should be evaluated. Do not touch the patient with signal input or output connectors.
18. Use only a hospital grade power supply cord.
19. This equipment has been tested and found to comply with the limit for a Class B digital device, pursuant to Part 15 of the FCC Rules. These limits are designed to provide reasonable generate uses and can radiate radio frequency energy, if not installed and used in accordance with the instructions, may cause harmful interference to radio communications. However, there is no guarantee that interference will not occur in a particular installation, which can be determined by turing the equipment off and on, the user is encourage to try to correct the interference by one or more of the following measures:
 - Reorient or relocate the receiving device.
 - Increase the separation distance between the equipment.
 - Connect the equipment to an outlet on a circuit different from that to which the other device(s) are connected.
 - Consult the manufacturer or field service technician for help.
20. Grounding reliability can only be achieved when the equipment is connected to an equipment receptacle labeled "Hospital Only" or "Hospital Grade."

Note To connect to an international power supply, use a an attachment plug appropriate for the power outlet.

Note Refer to the "Electromagnetic Compatibility" (EMC) section of this manual to ensure EMC. The AMM261WTD must be installed and operated according to the EMC information provided in this manual.

Symbol Definitions



Dangerous: High Voltage



Direct Current



Serial Number



This way up



Fragile, handle with care



Stacking limit by number



Keep dry



Recyclable



See accompanying document



Indicates proof of conformity to applicable European Economic Community Council directives and to harmonized standards published in the official journal of the European Communities.



Authorized Representative in Europe



Date of Manufacture



Indicates protective earth ground.



For indoor use only.



Tested to comply with FCC Class B standards.



DC power control switch



Tested to comply with Japan VCCI certification



Tested to comply with China CCC certification



China RoHS symbol. Number indicates EFUP (Environmental Friendly Use Period) from the date of manufacturing.



Medical Equipment is in accordance with UL 60601-1 and CAN/CSA C22.2 No. 601.1 in regards to electric shock, fire hazards, and mechanical hazards



Tested to comply with IP (ingress protection) Rating



WEEE symbol for the recyclable product. Please do not throw the product with this symbol in the bin.



Manufacturer

EU Declaration of Conformity for Medical Applications

A Declaration of Conformity has been filed for this product. A sample of this document may be found in the addendum which accompanied this manual. For a copy of the Declaration of Conformity document, please contact ADVAN Int'l Corp. and request for AMM261WTD DOC.

Prepare for Unpack

Before you unpack your monitor, prepare a suitable workspace. You need a stable and level surface near a grounded wall outlet in an area which is relatively free of glare from sunlight or other sources of bright light. The monitor is cooled by natural convection (it has no fan). For optimum performance, do not block the cooling vents.

While unpacking the monitor, inspect it and other package contents for shipping damage that could cause a fire or shock hazard. Immediately report any shipping damage to the carrier or transportation company and contact customer service for monitor in the future or in case of return.

After you unpack the monitor, make sure the following items are included

- Monitor with video cable
- AC adapter with cable

 CAUTION: AC Adapter must be plugged into Grounded a power outlet

 CAUTION : AC adapter
Model No: BPM150S24F10

- This operations manual

 Note: Your system provider may offer alternative cords or cables depending on the installation requirement and local geography issues.

SAFETY PRECAUTION

- Avoid placing the monitor, or any other heavy object, on the power cord to prevent fire or electrical shock from damage to the power cord.
- Do not expose the monitor to rain, excessive moisture, or dust to avoid fire or shock hazard.
- Do not cover the slots or openings of the monitor for proper heat dissipation. Always put the monitor in a place where there is adequate ventilation.
- Avoid placing the monitor against a bright background or where sunlight or other light sources may reflect on the area of the monitor. Place the monitor just below eye level.
- Handle with care when transporting the monitor.
- Refrain from giving the shock or scratch to the screen, as screen is fragile.

CLEANING YOUR MONITOR

No specific liquid or chemical necessary when cleaning this LCD monitor. However, we suggest to clean the monitor with non-abrasive cloths and cleaning solutions used in hospitals to clean similar equipment. We recommend using 70% Isopropyl alcohol for the screen surface and warm water and a mild detergent for all other surfaces. Other acceptable cleaning agents are listed below:

- 70% isopropyl alcohol
- Cidex (2.4% glutaraldehyde solution)
- 0.5% Chlorhexidine in 70% isopropyl alcohol

To clean the screen, do not spray liquid cleaners directly on to the unit. Stand away from the monitor and spray cleaning solution onto a cloth. Without applying excessive pressure, clean the screen with the slightly dampened rag.

Recommendation to Use more than One Unit

As unforeseen situation can occasionally occur for the monitor, when the display is used for safety control of human, equipments or unstable picture, or for emergencies, we strongly recommend you use more than one unit or prepare a spare unit.

On Burn-in

Permanent burn-in may occur from the followings:

- Displaying color bar or static images repeatedly or for a long period of time.
- Using the unit repeatedly in a high temperature/ high humidity environment
- Displaying an image smaller than the monitor continuously.

To reduce the risk of burn-in, we recommend turning off the power of the unit, and reducing the brightness when the unit is not in use.

POWER MANAGEMENT FUNCTION

The monitor is equipped with the power management function which automatically reduce the power consumption when not in use in three power level modes.

- **Stand-by Mode**

The monitor goes into stand-by mode when the horizontal sync signal is off for about 10 seconds. In this mode, the screen goes off and the power LED blinks for 1 seconds On and 1 second Off. The screen is displayed after the horizontal sync signal is restored.

- **Suspend Mode**

The monitor goes into suspend mode when the vertical sync signal is off for about 10 seconds. The power consumption during this is 10 W. In this mode, the screen goes off and the power LED blinks for 1 seconds On and 1 second Off. The screen is displayed after the vertical sync signal is restored.

- **Off Mode**

The monitor goes into power-off mode when the vertical and horizontal sync signals are off for about 10 seconds. In this mode, the screen goes off and the power LED blinks for 1 seconds On and 1 second Off. The screen is displayed after the vertical and horizontal sync signals are restored.

Power Management System

The AMM261WTD Medical Monitor power management proposal. Provides four phases of power-saving modes by detecting the horizontal sync signal as shown in the table below.

State	Normal Operation	DPMS Standby	DPMS Suspend	DPMS Off
Horizontal Sync	Active	Inactive	Active	Inactive
Vertical Sync	Active	Active	Inactive	Inactive
Video	Active	Blanked	Blanked	Blanked
Power Indicator	Green	Green Flashing (1 sec. Interval)	Green Flashing (1 sec. Interval)	Green Flashing (1 sec. Interval)
Power Consumption	50 W	10 W	10 W	10 W

When the monitor is power saving mode or detects an incorrect timing, the screen will be blank and power LED indicator will blink.

PRESET MODES**DVI and VGA input signal formats**

Resolution	Horizontal frequency (KHz)	Vertical frequency (Hz)	Pixel clock (MHz)
640 x 350 @70Hz	31.469	70.087	25.175
640 x 480 @60Hz	31.469	59.940	25.175
640 x 480 @75Hz	37.500	75.000	31.500
800 x 600 @56Hz	35.156	56.250	36.000
800 x 600 @60Hz	37.879	60.317	40.000
800 x 600 @75Hz	46.875	75.000	49.500
1024 x 768 @60Hz	48.363	60.004	65.000
1024 x 768 @70Hz	56.476	70.069	75.000
1024 x 768 @75Hz	60.023	75.029	78.750
1152 x 864 @60Hz	54.348	60.053	80.000
1152 x 864 @70Hz	63.955	70.016	94.200
1152 x 864 @75Hz	67.500	75.000	108.000
1280 x 1024 @60Hz	63.981	60.020	108.000
1600 x 1200 @60Hz	75.000	60.000	162.000
1920 x 1200@60Hz	74.099	59.999	154.125

Video Signals

Format	DVI	VGA/ SOG	Video	Y/C	SDI1/2	Component		
						Y/Pb/Pr	RGB+ CS	RGB+ HV
NTSC *1			○	○				
PAL *2			○	○				
480/59.94i		○			○	○	○	○
480/59.94p						○	○	○
576/50i		○			○	○	○	○
576/50p	○	○				○	○	○
720/50p	○	○			○	○	○	○
720/59.94p	○	○			○	○	○	○
720/60p	○	○			○	○	○	○
1035/59.94i		○			○	○	○	○
1035/60i		○			○	○	○	○
1080/23.98psf		○			○	○	○	○
1080/24psf		○			○	○	○	○
1080/23.98p		○			○	○	○	○
1080/24p		○			○	○	○	○
1080/25p	○	○			○	○	○	○
1080/29.97p	○	○			○	○	○	○
1080/30p	○	○			○	○	○	○
1080/50i	○	○			○	○	○	○
1080/59.94i	○	○			○	○	○	○
1080/60i	○	○			○	○	○	○
1080/50p	○	○			○ *3			
1080/60P	○	○			○ *3			

*1 NTSC-M, NTSC-433

*2 PAL-BDGHI, PAL-M, PAL-N, PAL-60

*3 3G-SDI signal

PIP / POP / PBP function

The following combination options are available to you:

Main \ PIP	VGA	DVI	SDI1	SDI2	C-Video	Y/C	Component/ RGBs	SOG
VGA	<input type="radio"/>	<input type="radio"/>	<input type="radio"/>	<input type="radio"/>	<input type="radio"/>	<input type="radio"/>	<input type="radio"/>	
DVI	<input type="radio"/>	<input type="radio"/>	<input type="radio"/>	<input type="radio"/>	<input type="radio"/>	<input type="radio"/>	<input type="radio"/>	<input type="radio"/>
SDI1	<input type="radio"/>	<input type="radio"/>	<input type="radio"/>		<input type="radio"/>	<input type="radio"/>	<input type="radio"/>	<input type="radio"/>
SDI2	<input type="radio"/>	<input type="radio"/>		<input type="radio"/>	<input type="radio"/>	<input type="radio"/>	<input type="radio"/>	<input type="radio"/>
C-Video	<input type="radio"/>	<input type="radio"/>	<input type="radio"/>	<input type="radio"/>	<input type="radio"/>	<input type="radio"/>	<input type="radio"/>	
Y/C	<input type="radio"/>	<input type="radio"/>	<input type="radio"/>	<input type="radio"/>	<input type="radio"/>	<input type="radio"/>	<input type="radio"/>	<input type="radio"/>
Component/ RGBs	<input type="radio"/>	<input type="radio"/>	<input type="radio"/>	<input type="radio"/>	<input type="radio"/>	<input type="radio"/>	<input type="radio"/>	<input type="radio"/>
SOG		<input type="radio"/>	<input type="radio"/>	<input type="radio"/>		<input type="radio"/>	<input type="radio"/>	<input type="radio"/>

DDC

To make your installation easier, the monitor is able to Plug and Play with your system if your system also supports DDC protocol. The DDC (Display Data Channel) is a communication protocol through which the monitor automatically informs the host system about its capabilities, for example, supported resolutions and corresponding timing. The monitor supports DDC1 and DDC2B standard.

INSTALLATION

To install the monitor to your host system, please follow the steps as given below:

Steps

1. Use the supplied video cable (DVI, VGA, S-Video, C-Video) then connect to the host system accordingly.
2. Connect the DC power to the DC power connector on the monitor.
3. Connect one end of AC power cord into the AC Adapter and the other end to AC power outlet.
4. Then turn the host system on and then the monitor.
5. If the monitor still does not function properly, please refer to the troubleshooting section to diagnose the problem.

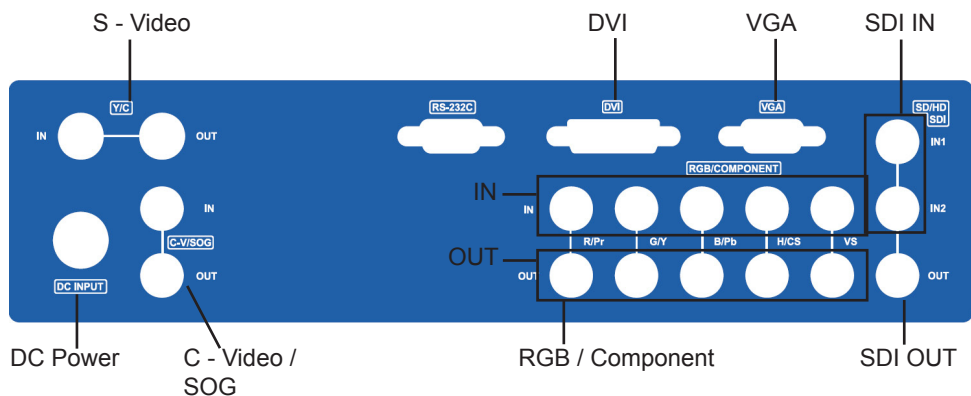

CONNECTING the POWER CORD

- * Check first to make sure that the power cord you use is the correct type required for your area.
- * This monitor has an universal AC adapter that allows operation in either AC 100 - 240 V ac voltage area. No user-adjustment is required.
- * Plug one end of the power cord to the AC adapter, plug another end to a proper AC outlet.

The cord set should have the appropriate safety approvals for the country in which the equipment will be installed and marked HAR.

For 120 volt Applications, use only UL Listed detachable power cord with NEMA configuration 5-15P type (parallel blades) plug cap. For 240 volt applications use only UL Listed Detachable power supply cord with NEMA configuration 6-15P type (tandem blades) plug cap.

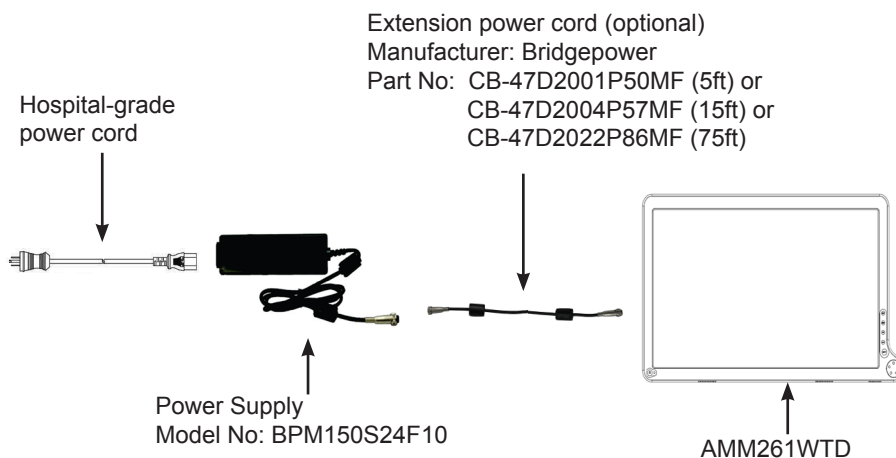

Key Name and Function

Power LED : Lights up to indicate the power is turned ON.

Standby Power Button: To power ON or OFF the monitor.

Rotary switch : With the OSD menu activated, increases the value of the selected (Turn Right) parameter or moves rightward in OSD menu.

Rotary switch : With the OSD menu activated, increases the value of the selected (Turn Left) parameter or moves leftward in OSD menu.

PIP Switch : To enable or disable Picture In Picture function.

PBP Switch : To enable or disable Picture By Picture function.

POP Switch : To enable or disable Picture On Picture function.

Adjust Switch : To activate or deactivate image adjustment in sub screen of PIP, PBP, POP mode.

Input Switch : To change the video source.

Power Switch : To turn ON or OFF the system.

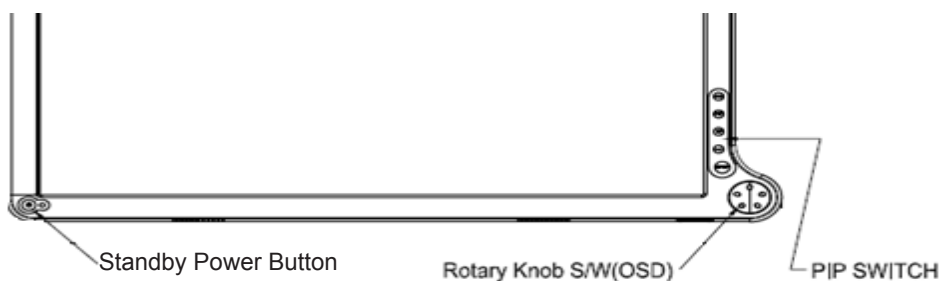

How to access the menu.

1. Push the “Knob” button to activate the OSD menu.
2. Able to turn left or right the button to select those icons. The icon will be highlighted when is selected.
3. Push the “knob” button to go into the another OSD menu.
4. Turn left or right “Knob” button to increase or decrease the number of selected function.
5. In order to exit from the OSD menu in a different layer, then choose the “Exit option”. In case of long pushing and holding the button around two or three seconds, then it will completely out from the menu regardless wherever you are.
6. Turn the “Knob” button in a fast way to the left or right, while the menu is not activated, then input signal menu will turns up with “V” mark which is chosen current available input signal. You can switch to another input signal source by turning the knob slowly then select the target source by pushing the knob.

OSD Section

Main Menu



Chromatic

Adjust Color Temp, Gamma

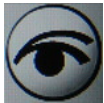

Visual

Adjust Brightness, Contrast, Phase, Chroma, Sharpness-H, Sharpness-V



Setting

Adjust Scale Mode, Color Space, Mirror, Freeze Frame, Zoom / Pan, PIP, POP, PBP



Advanced

Adjust OSD Position Control, Screen Control, DPMS, Auto Source Select, Smart Select, Restore Factory, Key Lock, Overscan



Information

Adjust Custom Entry, SN, Run Time, Input Format

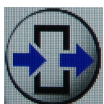

Exit

Exit the menu

OSD Section



Chromatic



Color Temp Change the color temperature - D65, D93, S1, S2



Gamma Change the gamma value - 1.8, 1.9, 1.95, 2.1, 2.1S, 2.2, 2.3, 2.4, 2.4S, S0, Radio graph



Exit Exit the menu

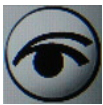

Visual



Brightness Adjust the brightness of panel (Range 0 - 100)



Contrast Adjust the contrast of video (Range 0 - 100)



Phase Adjust the phase of video (Range 0 - 100)
*available for C and S - video



Chroma Adjust the chroma of video (Range 0 - 100)
*available for C and S - video



Sharpness-V Set the sharpness of vertical image (Range 0 - 100)



Sharpness-H Set the sharpness of horizontal image (Range 0 - 100)

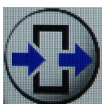

Exit Exit the menu

OSD Section



Setting



Scale Mode Change the scale mode - Fill all, One to One, Vertical - fill, Horizontal - fill, Fill aspect ratio



Color Space Change color space between RGB and YPbPr
*available for Component and RGBS



Mirror Off/On mirror image



Freeze Frame Off / On freeze frame



Zoom / Pan Enable zoom - in and pan function



PIP Enable PIP (Picture In Picture) function



POP Enable POP (Picture On Picture) function









PBP Enable PBP (Picture By Picture) function







Exit Exit the menu

Sub menu of PIP

	Mode	PIP Mode ON / Off
	Source	PIP sub screen source - SDI1/2, C-Video, S-Video, Component/RGB, VGA, DVI
	Position	PIP sub screen position - Top L, Top R, Bottom L, Bottom R
	Size	PIP sub screen size - Small, Medium, Large
	Blending	PIP sub screen blending (Range 0 - 100)
	Swap	PIP sub screen swap
	Exit	Exit the menu

Sub menu of PBP

	Mode	PBP Mode ON / Off
	Source	PBP sub screen source - SDI1/2, C-Video, S-Video, Component/RGB, VGA, DVI
	Swap	PBP sub screen swap
	Exit	Exit the menu

OSD Section**Sub menu of POP**

Mode POP Mode ON / Off



Source POP sub screen source - SDI1/2, C-Video, S-Video, Component/RGB, VGA, DVI



Position POP sub screen position - Top L, Top R, Bottom L, Bottom R



Size POP sub screen size - Small, Medium, Large



Blending POP sub screen blending (Range 0 - 100)



Swap POP sub screen swap



Exit Exit the menu

OSD Section



Advanced



OSD Position Control Change the OSD menu - Position, Background, OSD time out, Language



Screen Control Control and adjust H and V position, Frequency, Phase Noise Reduction, Motion Offset



DPMS Change the DPMS



Auto Source Select Adjust Auto Source Select between on and off



Smart Select Enable / Disable smart select sub menu



Restore Factory Changes the all OSD value to factory outgoing status



Key Lock Set to key lock mode



Overscan Adjust Overscan ratio



Exit Exit the menu

OSD Section

Sub menu of OSD Control



H-position Adjust OSD H - position (Range 0 - 100)



V-position Adjust OSD V - position (Range 0 - 100)



Back ground Adjust transparency of OSD back ground (Range 0 - 100)



OSD Time out Adjust OSD time out - 5s, 10s, 15s, 20s, 1m, 2m



Language OSD language - English, Japanese, Chinese, Korean, French, German



Exit Exit the menu

Sub menu of Screen Control



H-position Adjust screen H - position (Range 0 - 100)
*available for VGA, SDI, Component



V-position Adjust screen V - position (Range 0 - 100)
*available for VGA, SDI, Component



Frequency Adjust frequency (Range 0 - 100)
*available for VGA



Phase Adjust phase (Range 0 - 100)
*available for VGA



Noise Reduction Noise reduction (Range 0 - 100)



Motion Offset Motion offset (Range 0 - 100)



Exit Exit the menu



Information



Custom Entry Change the user or monitor's name



SN Display the serial number



Run Time Display the total run time



Input Format Display the current input resolution and vertical frequency



Exit Exit the menu

TROUBLESHOOTING

Before sending your LCD monitor for servicing, please check the troubleshooting list below to see if you can self-diagnose the problem.



Problems	Current Status	Remedy
No Picture	LED ON	· Using OSD, adjust brightness and contrast to maximum or reset to their default settings.
	LED OFF	· Check the Standby Power Button and Power switch.
		· Check if AC power cord is properly connected to the AC adapter.
	LED Blinking	· Check if video signal cable is properly connected at the back of monitor.
· Check if the power to computer system is ON.		
Abnormal Picture	Unstable Picture	· Check if the specification of graphics adapter and monitor is in compliance which may be causing the input signal frequency mismatch.
	Display is missing, center shift, or too small or too large in display size	· Using the Screen Control Menu, adjust the Phase, Frequency, Horizontal, and Vertical settings in order to correct the display image.

SPECIFICATION*

Model	AMM261WTD		
Description	a-Si TFT Active Matrix, LED Backlight		
Active Screen Size	26 inches diagonal		
Resolution	1920 (H) x 1080 (V) @60Hz		
Pixel Pitch	0.30 mm		
Display Color	1.07B colors		
Color Tone	Up to 256 color tone		
Response Time	<25ms Typ.		
Face Finishing	Protective Filter with Anti-Reflected Hard Coated		
Viewing Angle	R/L 178°, U/D 178° (CR > 10)		
Brightness**	450 cd/m2 (Typ.)		
Contrast Ratio	1400:1 (Typ.)		
Input	Output		
Composite Video	BNC x 1	Composite Video	BNC x 1
	1.0 Vp-p		1.0 Vp-p
Y/C Video	4 pin Mini Din x 1	Y/C Video	4 pin Mini Din x 1
	Luminance (Y) : 1.0± 0.1Vp-p		Luminance (Y) : 1.0± 0.1Vp-p
	Chrominance (C) : 0.3± 0.03Vp-p		Chrominance (C) : 0.3± 0.03Vp-p
Component/RGB	BNC x 5 (Y/Pb/Pr , RGBs , R/G/B/H/V)	Component/RGB	BNC x 5 (Y/Pb/Pr , RGBs , R/G/B/H/V)
	RGB: 0.7 ± 0.1 Vp-p		RGB: 0.7 ± 0.1 Vp-p
	Composite Sync : 0.3Vp-p ~ 5Vp-p		Composite Sync : 0.3Vp-p ~ 5Vp-p
	H/V SYNC : TTL Level		H/V SYNC : TTL Level
SDI1/2	3G/HD/SD SDI, BNC x1	SDI1/2	3G/HD/SD SDI, BNC x1
VGA	15pin D-Sub x 1		
	R/G/B : 0.7 ± 0.1 Vp-p		
	H/V Sync : TTL Level (V high ≥2.3V, V low ≤0.5V)		
DVI	DVI-I x 1		
Remote Input	9-pin D-Sub (RS-232C) x 1		
Scanning Frequency	Horizontal : 31.47~80.0Khz Vertical : 50~85Hz		
General			
Power Adaptor	AC 100 ~ 240V 50-60Hz, 2.0A		
	DC 24V, 6.25A		
Power Consumption	TBD W		
Dimension	643.7(W) x 394.8 (H) x 79.8 (D) mm		
Weight	Monitor : TBD		
	AC adaptor : TBD		
VESA Mounting	100mm x 100mm		
Operating/Storage Environment			
Operating Temperature	32° ~ 95°F (0° - 35°C)		
Operating Humidity	20% ~ 80%, non-condensing		
Storage Temperature	-4° ~ 140°F (-20° - 60°C)		
Storage Humidity	10 ~ 85%RH (without condensation)		
Compliance & Certification			
Safety	UL (UL60601-1), cUL (CAN/CSA-C22.2 No.6011-M90), CE (EN60601-1), AS/NZS 3200-1-0, CCC (GB4943.1), CB-ITE (IEC60950-1), IP23 Compliance		
EMC	FCC (Part 15 Class B), CE (EN60601-1-2), AS/NZS 3200-1-2, VCCI (Class B), CCC (GB9254, GB17625.1)		
Optional Module			
DC Extension Cable	5ft, 15ft, 75ft length		
Base Stand	Adjustable high, swivel and tilt base stand		

* All contents are subject to change without notice.

**Brightness shown is without A/R filter installed.

	: Direct Current
	MEDICAL EQUIPMENT WITH RESPECT TO ELECTRIC SHOCK, FIRE AND MECHANICAL HAZARDS ONLY IN ACCORDANCE WITH UL 60601-1, AND CAN/CSA C22.2 NO. 601.1 : UL approval mark according to the safety standard for Medical equipment

This monitor is intended for use in Health Care Facilities model AMM261WTD

Equipment is not suitable for use in the presence of flammable anesthetic mixture with air or with oxygen or nitrous oxide.

No user serviceable parts inside, ask qualified personnel when accessing inside.

For disposal of waste product, follow the requirement of local code.

Electrical input rating: 24V DC 6.25A

Classification

Type of protection against electric shock: Class I Equipment.

Degree of protection against the ingress of water: IP23 compliance.

Mode of operation: Continuous

This monitor has been tested to comply with IEC/EN 60601-1, IEC/EN60601-1-2 and is certified by UL to medical standard UL60601-1(UL/cUL Mark).

Because many medical offices are located in residential areas, this monitor, in addition to the medical requirements, has also been tested and found to comply with the limits for FCC Class B computing devices in a typically configured system. It is the system integrator or configurer's responsibility to test and ensure that the entire system complies with applicable EMC laws.

Environmental conditions for transport and storage:

- Temperature range within -4° to 140° F (-20° to 60°C)
- Relative humidity range within 10% to 85%
- Atmospheric pressure range within 500 to 1060 hPa.

Electromagnetic Compatibility

Like other electrical medical equipment, the AMM261WTD requires special precautions to ensure electromagnetic compatibility with other electrical medical devices. To ensure electromagnetic compatibility (EMC), the AMM261WTD must be installed and operated according to the EMC information provided in this manual.

Note The AMM261WTD has been designed and tested to comply with IEC 60601-1-2:2001 requirements for EMC with other devices.



Caution *Portable and mobile RF communications equipment may affect the normal function of the AMM261WTD.*



Warning *Do not use cables or accessories other than those provided with the AMM261WTD, as this may result in increased electromagnetic emissions or decreased immunity to such emissions.*



Warning *If the AMM261WTD is used adjacent to or stacked with other equipment, observe and verify normal operation of the AMM261WTD in the configuration in which it will be used prior to using it in a surgical procedure. Consult the tables below for guidance in placing the AMM261WTD.*

Manufacturer's declaration - electromagnetic emission

The Model AMM261WTD is intended for use in the electromagnetic environment specified below. The customer or the user of AMM261WTD should assure that it is used in such an environment.		
Emission test	Compliance	Electromagnetic environment - guidance
RF emissions CISPR 11	Group 1	The Model AMM261WTD uses RF energy only for its internal function. Therefore, its RF emissions are very low and are not likely to cause any interference in nearby electronic equipment
RF emissions CISPR 11	Class B	AMM261WTD is suitable for use in all establishments, including domestic establishments and those directly connected to the public low-voltage power supply network that supplies buildings used for domestic purposes
Harmonic emissions IEC61000-3-2	Class D	
Voltage Fluctuations IEC61000-3-3	Complies	

Manufacturer's declaration - electromagnetic immunity

The Model AMM261WTD is intended for use in the electromagnetic environment specified below. The customer or the user of AMM261WTD should assure that it is used in such an environment.			
Immunity Test	IEC 60601 Test Level	Compliance Level	Electromagnetic environment - guidance
Electrostatic discharge (ESD) IEC61000-4-2	6 kV contact 8 kV air	6 kV contact 8 kV air	Floors should be wood, concrete or ceramic tile. If floors are covered with synthetic material, the relative humidity should be at least 30%.
Electrical fast transient /burst IEC61000-4-4	2 kV for power supply lines 1 kV for input / output lines	2 kV for power supply lines 1 kV for input / output lines	Mains power quality should be that of a typical commercial or hospital environment.
Surge IEC61000-4-5	1 kV differential mode 2 kV common mode	1 kV differential mode 2 kV common mode	Mains power quality should be that of a typical commercial or hospital environment.

Power frequency (50/60Hz) magnetic field IEC 61000-4-8	3.0 A/m	3.0 A/m	Power frequency magnetic fields should be at levels characteristic of a typical location in a typical commercial or hospital environment.
Voltage dips, short interruptions and voltage variations on power supply input lines IEC61000-4-11	<p><5% Ut (>95% dip in Ut) for 0.5 cycle</p> <p>40% Ut (60% dip in Ut) for 5 cycles</p> <p>70% Ut (30% dip in Ut) for 25 cycles</p> <p><5% Ut (>95% dip in Ut) for 5 sec.</p>	<p><5% Ut (>95% dip in Ut) for 0.5 cycle</p> <p>40% Ut (60% dip in Ut) for 5 cycles</p> <p>70% Ut (30% dip in Ut) for 25 cycles</p> <p><5% Ut (>95% dip in Ut) for 5 sec.</p>	Mains power quality should be that of a typical commercial or hospital environment. If the user of the AMM261WTD image intensifier requires continued operation during power mains interruptions, it is recommended that the AMM261WTD image intensifier be powered from an uninterruptible power supply or a battery.
Note: Ut is the A.C. mains voltage prior to application of the test level.			

Manufacturer’s declaration - electromagnetic immunity

<p>The Model AMM261WTD is intended for use in the electromagnetic environment specified below. The customer or the user of AMM261WTD should ensure that it is used in such an environment.</p>			
Immunity Test	IEC 60601 Test Level	Compliance Level	Electromagnetic environment - guidance
<p>Conducted RF IEC61000-4-6</p> <p>Radiated RF IEC 61000-4-3</p>	<p>3 Vrms 150 KHz to 80 MHz</p> <p>3 V/m 80MHz to 2.5 GHz</p>	<p>3 Vrms 150 KHz to 80 MHz</p> <p>3 V/m 80MHz to 2.5 GHz</p>	<p>Portable and mobile RF communications equipment should be used no closer to any part of the AMM261WTD, including cables, than the recommended separation distance calculated from the equation applicable to the frequency of the transmitter.</p> <p>Recommended Separation Distance</p> <p>0.15 MHz to 80 MHz</p> $d = \left[\frac{3.5}{V_1} \right] \sqrt{P}$ <p>80 MHz to 800 MHz</p> $d = \left[\frac{3.5}{E_1} \right] \sqrt{P}$ <p>800 MHz to 2.5 GHz</p> $d = \left[\frac{2}{E_1} \right] \sqrt{P}$ <p>where P is the maximum output power rating of the transmitter in watts (W) according to the transmitter manufacturer and d is the recommended separation distance in meters (m).</p> <p>Field strengths from fixed RF transmitters, as determined by an electromagnetic site survey (a), should be less than the compliance level in each frequency range (b). Interference may occur in the vicinity of equipment marked with the following symbol:</p> 
NOTE 1: At 80MHz and 800MHz, the higher frequency range applies.			
NOTE 2: These guidelines may not apply in all situations. Electromagnetic propagation is affected by absorption and reflection from structures, objects, and people.			
<p>(a) Field strengths from fixed transmitters, such as base stations for radio (cellular/cordless) telephones and land mobile radios, amateur radio, AM and FM radio broadcast and TV broadcast, cannot be predicted theoretically with accuracy. To assess the electromagnetic environment due to fixed RF transmitters, an electromagnetic site survey should be considered. If the measured field strength in the location in which the AMM261WTD is used exceeds the applicable RF compliance level above, the AMM261WTD should be observed to verify normal operation. If abnormal performance is observed, additional measures may be necessary, such as reorienting or relocating the AMM261WTD.</p> <p>(b) Over the frequency range 150kHz to 80MHz, field strengths should be less than [V1] V/m.</p>			

Recommended Separation Distances Between Portable and Mobile RF Communications Equipment and the AMM261WTD System			
The AMM261WTD system is intended for use in an electromagnetic environment in which radiated RF disturbances are controlled. The user of the AMM261WTD system can help prevent electromagnetic interference by maintaining a minimum distance between portable and mobile RF communications equipment (transmitters) and the AMM261WTD system as recommended below, according to the maximum output power of the communications equipment.			
Rated maximum output power (W) of transmitter	Separation distance (m) according to frequency of transmitter		
	150kHz to 80MHz $d=1.17\sqrt{P}$	80MHz to 800MHz $d=1.17\sqrt{P}$	800MHz to 2.5GHz $d=2.33\sqrt{P}$
0.01	0.12	0.12	0.23
0.1	0.37	0.37	0.74
1	1.17	1.17	2.33
10	3.70	3.70	7.37
100	11.70	11.70	23.30

For transmitters rated at a maximum output power not listed above, the recommended separation distance (d) in meters (m) can be estimated using the equation applicable to the frequency of the transmitter, where P is the maximum output power rating of the transmitter in watts (W) according to the transmitter manufacturer.

NOTE 1: At 80 MHz and 800 MHz, the separation distance for the higher frequency range applies.

NOTE 2: These guidelines may not apply in all situations. Electromagnetic propagation is affected by absorption and reflection from structures, objects, and people.

Dimension Drawing (mm) of AC Adapter

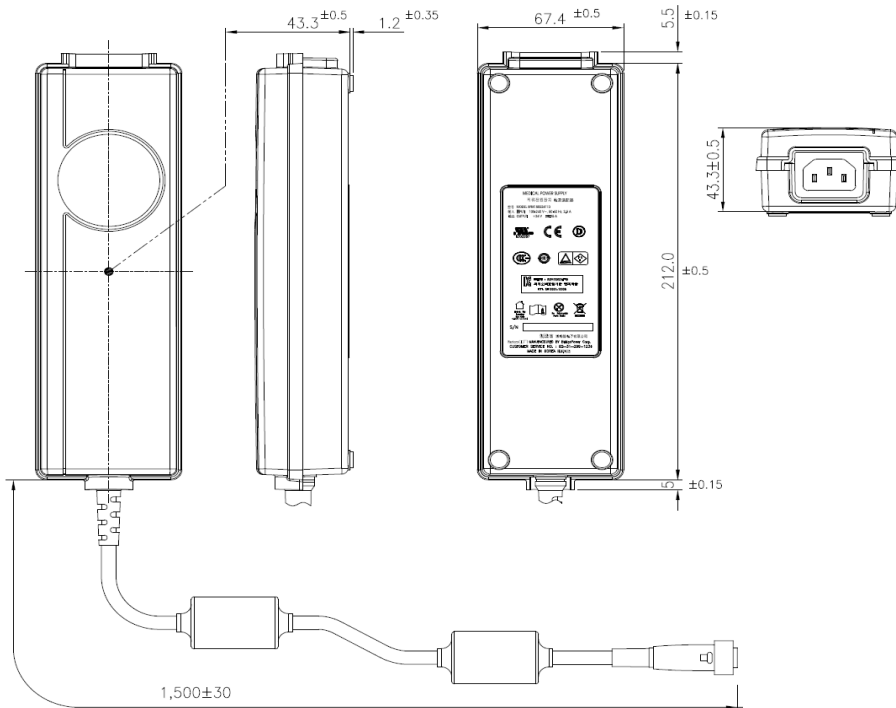

Dimension Drawing (mm) of AMM261WTD

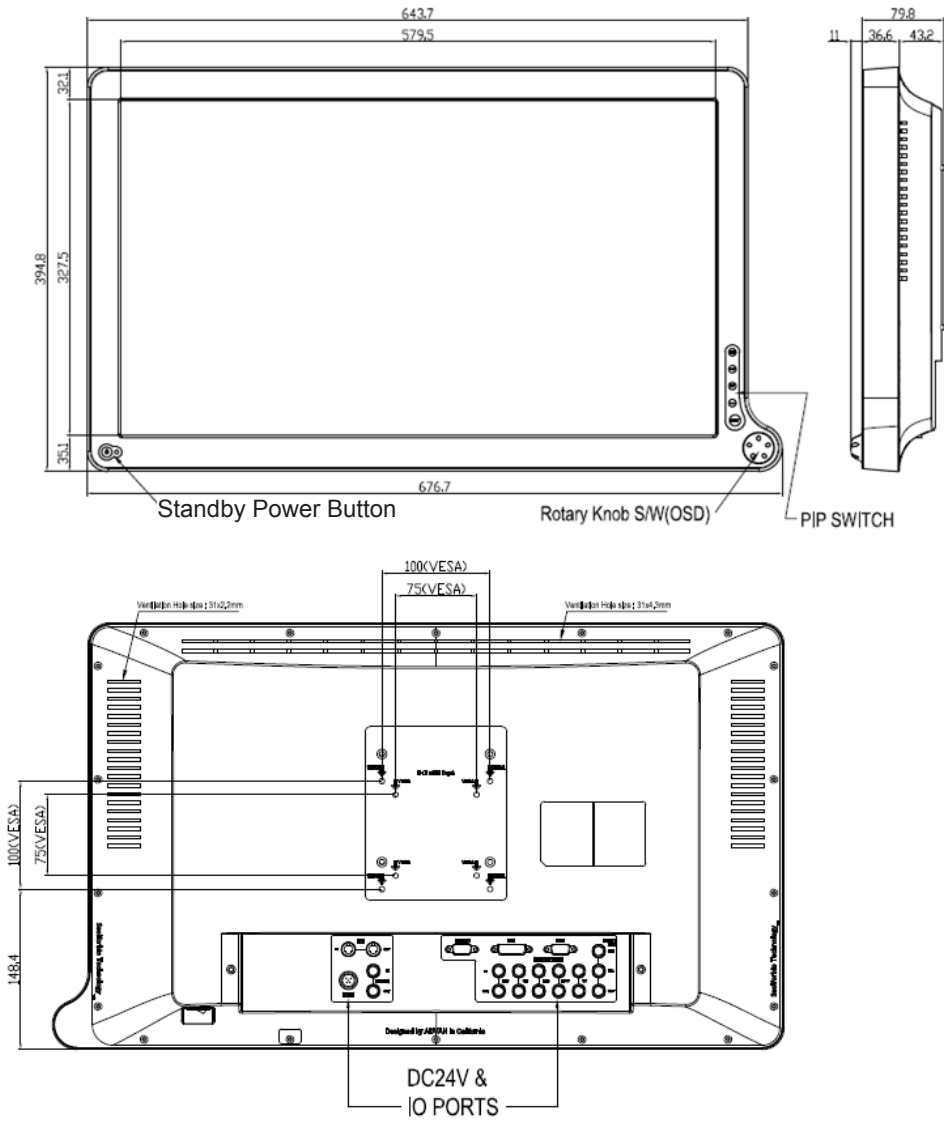

Connectors

DC Input

Connector Jack Power Input

Pin	Description	Pin	Description
1	GND	4	NC
2	GND	5	VCC_24V
3	VCC_24V		

Video Input

24 pin DVI-I connector.

DDWG or equivalent connector.

Pin	Description	Pin	Description	Pin	Description
1	T.M.D.S. Data2-	11	T.M.D.S. Data1 Shield	21	NC
2	T.M.D.S. Data2+	12	NC	22	T.M.D.S. Clock Shield
3	T.M.D.S. Data2 Shield	13	NC	23	T.M.D.S. Clock+
4	NC	14	+5V Power	24	T.M.D.S. Clock-
5	NC	15	Ground (for +5V)	25	Analog Red
6	DDC Clock	16	Hot Plug Detect	26	Analog Green
7	DDC Data	17	T.M.D.S. Data0-	27	Analog Blue
8	Analog V - Sync	18	T.M.D.S. Data0+	28	Analog H - Sync
9	T.M.D.S. Data1-	19	T.M.D.S. Data0 Shield	29	GND(for analog signal)
10	T.M.D.S. Data1+	20	NC		

15 pin VGA connector.

Pin	Description	Pin	Description	Pin	Description
1	GREED	6	GND	11	NC
2	GGREEN	7	GND	12	GSDA
3	GBLUE	8	GND	13	IHS
4	GND	9	G5V	14	IVS
5	GND	10	GND	15	GSCL

S - Video connector.

Pin	Description	Pin	Description
1	CHROMINANCE	3	GND
2	LUMINANCE	4	GND

C - Video connector.

Pin	Description
1	DATA IN / OUT

Description of Warranty

ADVAN warrants to the first Buyer (Buyer) that the product purchased when shipped in its original container will conform to ADVAN specifications, and to any ADVAN approved specifications furnished to ADVAN by the Buyer, and will be free of defects in materials and workmanship. ADVAN warrants that the product purchased is manufactured from new components which meet ADVAN standards, quality and specifications.

Subject to the conditions and limitations set forth below, ADVAN will, at its option, either repair any component of its products that prove defective by reason of improper workmanship or materials or ADVAN has the exclusive right to replace with refurbished units or with an equivalent product. ADVAN warrants that the components used for repair, refurbished units or equivalent product will meet ADVAN standards, quality and specifications.

Commencement and Duration of Warranty

The product purchased will be warranted for a period of eighteen (18) months (excluding the LCD panel, touch screen, and the protection filter) from the date of shipment.

LCD panels and touch screens are warranted for a period of twelve (12) months from the date of shipment.

Protection filters are not warranted as damage to the protection filter is considered to be normal wear and tear and can be replaced at Buyer's cost.

Components used for repair, refurbished units or equivalent product will be warranted for a period of twelve (12) months from the date of repair.

Limitation of Warranty

This limited warranty does not cover any damage to this product or other non-ADVAN products that results from any of the following: improper installation or operation; accident; abuse; misuse; natural disaster; war; insufficient or excessive electrical supply; abnormal mechanical or environmental conditions; any unauthorized disassembly, repair or modification; normal wear and tear; tampering by anyone other than an ADVAN engineer or an ADVAN Authorized Service Center (ASC); the use of supplies, consumable items and conditions beyond the control of ADVAN, such as common carrier provided equipment and/or facilities; operation of ADVAN product in excess of the specifications. This limited warranty also does not apply to any product that has not been handled or packaged correctly, that has been sold as second-hand or has been resold contrary to the US export regulations, on which the original identification information (i.e. serial number, rating and/or warranty label) has been altered, obliterated or removed.

Return Material Authorization (RMA) Procedure

All claims must be submitted through the ADVAN website, whether in warranty or out, first Buyer, distributor or OEM. End Users who have purchased through a distributor or OEM, please contact the distributor or OEM.

<http://www.advancorprma.com>

Follow the instructions to receive an RMA number, shipping instructions and a shipping label to be placed on the outside of the shipping container. A serial number and a detailed reason for return are required.

In-transit damage is not covered by warranty. ADVAN will only pay for the return shipment by surface transportation.

Returns without an RMA number will not be accepted.

For product support, please e-mail details of your inquiry including product model: service@advancorp.com

In Warranty

ADVAN or its ASC will repair or replace if defective in material or workmanship without cost, for a period of eighteen (18) months, (LCD panels and touch screens for a period of twelve (12) months) after the date of shipment.

Buyer must notify ADVAN or its ASC of the defect before expiration of the warranty period, and request an RMA number. If the configuration has been modified in any manner, the product must be returned to its original configuration before any warranty service will be performed by ADVAN or its ASC. No goods are to be returned to ADVAN or its ASC without prior authorization. Buyer will be responsible for packaging (preferably original container) and shipping the defective goods to ADVAN or its ASC, shipping charges prepaid.

ADVAN or its ASC will return the in warranty product, at no cost to the buyer.

Out-of-Warranty

ADVAN or its ASC will repair or replace if defective in material or workmanship with fee, any product which the warranty period has expired (out-of-warranty).

Buyer must notify ADVAN or its ASC of the defect and request an RMA number. If the configuration has been modified in any manner, the product must be returned to its original configuration before any service will be performed by ADVAN or its ASC. No goods are to be returned to ADVAN or its ASC without prior authorization. Buyer will be responsible for packaging (preferably original container) and shipping the defective goods to ADVAN or its ASC, shipping charges prepaid.

ADVAN or its ASC will return the out-of-warranty product, at cost to the buyer.

Product End of Life (EOL)

In the event of an RMA of an EOL product(s), ADVAN will hold or store major components of its products for a period of five (5) years, after the EOL of its products. ADVAN shall continue to perform the service of its products as long as ADVAN holds or stores said components of the products, with reasonable charge.

The forgoing Warranty and Out-of-Warranty terms apply.

Disclaimer

THE FORGOING IS THE COMPLETE WARRANTY FOR ADVAN PRODUCTS AND SUPERSEDES ALL OTHER WARRANTIES AND REPRESENTATIONS, WHETHER ORAL OR WRITTEN. EXCEPT AS EXPRESSLY SET FORTH ABOVE, NO OTHER WARRANTIES ARE MADE WITH RESPECT TO ADVAN PRODUCTS AND ADVAN EXPRESSLY DISCLAIMS ALL WARRANTIES NOT STATED HEREIN, INCLUDING, TO THE EXTENT PERMITTED BY APPLICABLE LAW, ANY WARRANTY THAT MAY EXIST UNDER NATIONAL, STATE, PROVINCIAL OR LOCAL LAW INCLUDING BUT NOT LIMITED TO ANY IMPLIED WARRANTY ON NON-INFRINGEMENT, MERCHANTABILITY OR FITNESS FOR A PARTICULAR PURPOSE. ALL WARRANTIES, WHETHER EXPRESS OR IMPLIED, ARE LIMITED TO THE PERIODS OF TIME SET FORTH ABOVE. SOME STATES OR OTHER JURISDICTIONS DO NOT ALLOW THE EXCLUSION OF IMPLIED WARRANTIES OR LIMITATIONS ON HOW LONG AN IMPLIED WARRANTY LASTS, SO THE ABOVE LIMITATIONS MAY NOT APPLY.

ADVAN'S TOTAL LIABILITY UNDER THIS OR ANY OTHER WARRANTY, EXPRESSED OR IMPLIED, IS LIMITED TO REPAIR OR REPLACEMENT, AND ARE THE SOLE AND EXCLUSIVE REMEDIES FOR BREACH OF WARRANTY OR ANY OTHER LEGAL THEORY. TO THE FULLEST EXTENT PERMITTED BY APPLICABLE LAW, ADVAN SHALL NOT BE LIABLE TO THE PURCHASER OR END USER CUSTOMER OF AN ADVAN PRODUCT FOR ANY DAMAGES, EXPENSES, LOST DATA, LOST REVENUES, LOST SAVINGS, LOST PROFITS, OR ANY OTHER INCIDENTAL OR CONSEQUENTIAL DAMAGES ARISING FROM THE PURCHASE, USE OR INABILITY TO USE THE ADVAN PRODUCT, EVEN IF ADVAN HAS BEEN ADVISED OF THE POSSIBILITY OF SUCH DAMAGES. SOME STATES OR OTHER JURISDICTIONS DO NOT ALLOW THE EXCLUSION OR LIMITATION OF INCIDENTAL OR CONSEQUENTIAL DAMAGES, SO THE ABOVE LIMITATIONS MAY NOT APPLY.

THE LIMITED WARRANTY GIVES YOU SPECIFIC LEGAL RIGHTS, AND YOU MAY ALSO HAVE OTHER RIGHTS WHICH VARY FROM STATE TO STATE OR JURISDICTION TO JURISDICTION.

Accessory Item List

	Parts Name	Q'ty	Description	Remark
1	AC- Adaptor	1	Model Number: BPM150S24F10 Parts Number: PS-52141209002E	BridgePower
2	VGA Cable	1	RGB 15P TO 15P, 1.8M, IVORY	
3	DVI cable	1	DVI-I type CABLE 29P TO 29P	
4	BNC Cable	1	BNC TO BNC ,1.8M/ RG58(JTC-15)	
5	S-Video Cable	1	S-VIDEO W.2F/C/1.8M,BLACK	
6	User's Manual	1	Rev. B	
7	Quick Reference Guide	1	Rev. A	
8	Power Cord*	1	Medical Grade 115V, GRAY	
9	VESA Screw	4	BH,+,M4x10,Ni	
10	Extension Power Cord**	1	Part No: CB-47D2001P50MF (5ft) or CB-47D2004P57MF (15ft) or CB-47D2022P86MF (75ft)	BridgePower

Adaptor



VGA Cable



DVI Cable



BNC Cable



S-Video Cable



User's Manual



QuickReference Guide



Power Cord*



VESA Screw



Extension Power Cord **



* Might vary pending on region standard

**Optional item, check with local representative

Exclusive Distributor

EIZO Corporation

153 Shimokashiwano, Hakusan, Ishikawa 924-8566 Japan

Tel: +81 76 275 4121

Fax: +81 76 275 4125

Web Page : <http://www.eizo.com>

Distributor

ADVAN Korea

#605, Kolon Science Valley 2-cha, 55, Digital-ro, 34-gil, Guro-gu, Seoul, 152-728
Korea

Tel : +82 2 783 5197

Fax : +82 2 868 0880

Web Page : <http://www.advancorp.com>

Manufacturer

ADVAN INT'L CORP

47817 Fremont Blvd. Fremont, CA 94538, USA

Tel : 1 510 490 1005

Fax : 1 510 490 1151

Web Page : <http://www.advancorp.com>

