

Table Of Contents

Owner's Guide

Arming the System	3
Disarming the System	4
Emergency Override	4
System Armed & Activated	5
Panic	5
Sensor By-Pass	5
Auxiliary Channel	6
Remote Controlled Anti-Carjack ..	6
Anti-Carjacking (Door & Ignition)..	7
Valet Mode	8
LED Status Indicator	8
Auxiliary Sensor & Prewarn	9

This device complies with Part 15 of the FCC Rules. Operation is subject to the following two conditions: (1) this device may not cause harmful interference, and (2) this device must accept any interference received, including interference that may cause undesired operation.

Notice : The changes or modifications not expressly approved by the party responsible for compliance could void the user's authority to operate the equipment.

IMPORTANT NOTE: To comply with the FCC RF exposure compliance requirements, no change to the antenna or the device is permitted. Any change to the antenna or the device could result in the device exceeding the RF exposure requirements and void user's authority to operate the device.

Remote Control Quick Reference Guide

Arming: Press & Release the "Lock" button



Silent Arming: Press & Release the "3rd" button Twice in 3 sec.

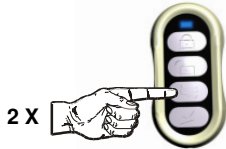

Disarming: Press & Release the "Unlock" button

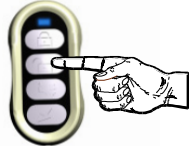

Silent Disarming: Press & Release the "3rd" button Twice in 3 sec

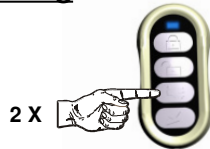

Emergency Override:



Panic: Press & Hold the "Lock" Button for 3 Sec's, with the ignition "Off"



Shock Sensor & Prewarn Bypass:

- 1) Arm the alarm by, Pressing & Releasing the "Lock" button
- 2) Within 2 seconds Press & Release the "3rd" button.



To Activate the Auxiliary Channel: Press & Hold The "3rd" Button for 3-Seconds

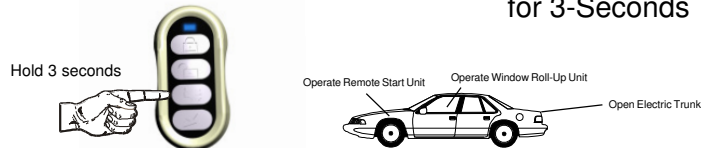

To Activate Remote Anti-Carjack: (programmable Dip-Switch # 7)
Press & Hold the "4th" button, for 3 Secs, with the ignition "On"

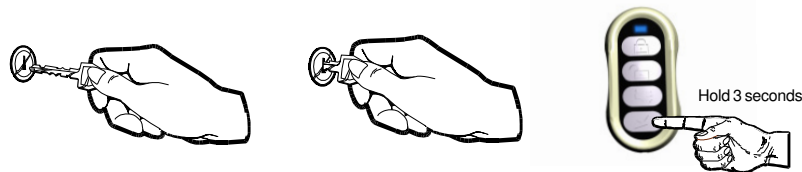

Arming the Alarm

The system may be "Armed" by any of 3 methods:

1) **Remote Control Arming:** Press & Release the "Lock" button

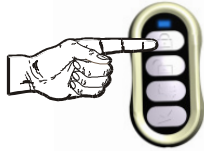

2) **SILENT Remote Control Arming:** Press & Release the "3rd" button Twice within 3 seconds

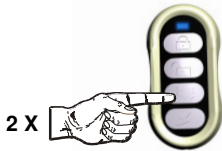

- Upon Arming:**
- The siren will chirp one time.
 - The parking lights will flash once.
 - The doors will lock. (If an optional interface is connected)
 - The starter interrupt will engage.
 - The LED Status Indicator will begin to flash slowly.

- If a zone is open, (for example a car door), when arming, the alarm will still arm, but will bypass the open zone until the zone is secured.

3) **To Passively Arm:** Turn Ignition "Off", Then Close all Doors.

Automatic "Last Door Arming" is a programmable feature which allows the alarm to arm itself and lock the doors, (if vehicle's door locks are connected).

If on, anytime the ignition is turned off, and then a door is opened and closed:

- The Siren will chirp once to confirm arming countdown has begun.
- The LED Status Indicator will begin to flash rapidly.

Thirty seconds later:

- The siren will chirp & the lights will flash once.
- The LED Status Indicator will begin to flash slowly.
- The starter interrupt will engage.

- The alarm is now fully armed. The doors will lock at this time, if the vehicle is equipped.

- The system can not Last Door Arm if a protected zone is open. Should a vehicle door be opened during the arming countdown, the countdown will stop and start over again when the door is closed. **AUTO REARM** (programmable) allows the Alarm to Rearm itself, if it is Disarmed and a vehicle door is not opened.

Disarming the Alarm

The system may be "Disarmed" by any of 3 methods:

1) Remote Control Disarming: Press & Release the "Unlock" button

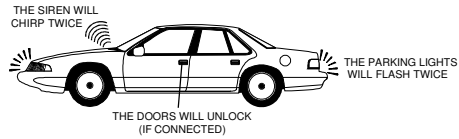

2) SILENT Remote Control Disarming: Press & Release the "3rd" button Twice within 3 sec

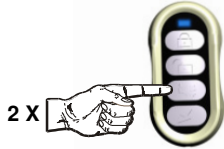

- Upon Disarm:**
- The siren will chirp twice. (4 chirps if alarm has activated & reset)
 - The parking lights will flash twice.
 - The doors will unlock. (If an optional interface is connected)
 - The starter interrupt will disengage.
 - The LED Status Indicator begins flashing rapidly for Automatic Rearming, until alarm Rearms or a vehicle door is opened.

2-STAGE DISARM: If Disarming the alarm while it is triggered (siren sounding), the first press of any remote control button will only silence the siren/horn. A second press of the "Unlock" button will Disarm the alarm.

Emergency Override

- Step 1: With the system in the armed condition, enter the vehicle via the driver's door (be aware that the alarm will trigger when the door is opened).
- Step 2: Using your key, turn the vehicle's ignition to the "On" position.
- Step 3: Within 10 seconds, Press & Release the Valet/ Override Switch.



System Armed & Activated

Regardless of method used to Arm the alarm, once Armed, the alarm will monitor all protected zones, and if an intrusion attempt is detected it will activate, or “trigger”.

A trigger consists of the following:

- The electronic siren, or optionally the vehicle’s horn, will start sounding.
- The exterior parking lights will flash on and off repeatedly.

An activation has a 30 second duration unless the system is disarmed using the remote control or the Valet /Override switch. If all protected zones are secure at the end of the trigger, the system will stop and rearm itself to detect further entry attempts. If a protected zone is still open at the end of the trigger cycle, the alarm will continue to re-trigger itself for up to six activated cycles before it resets itself and ignores the violated zone.

Remote Panic Operation

Should it be needed in a threatening situation, or you feel the need to attract attention, the alarm can be triggered using the remote control. Your alarm features “Panic Mode”, which allows you to activate “Panic” from the “Arm/Lock” button.

To Activate Remote Panic: Press & Hold the “Arm/Lock” Button, for 3 seconds, with the ignition “Off”.



Sensor By-pass

The shock sensor & Prewarn zone can be by-passed using the remote control. This may be useful in stormy weather.

1) Arm the alarm by, Pressing & Releasing the “Lock” button.

2) Within 2 seconds, Press & Release the “3rd” button.



- The siren will chirp once to confirm sensor has been by-passed.
- Upon Disarming the alarm, the sensor zone will reset.

The Auxiliary Channel

The Auxiliary Channel may be used to operate an optional function. Possibilities include remote trunk release, remote car starting, or an on-demand remote window roll-up interface. Please see your Omega dealer for details on available options.

To Activate the Auxiliary Channel:

Press & Hold the "3rd" Button for 3 Seconds.

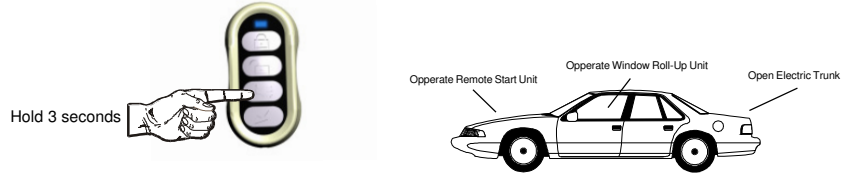

- The alarm will Disarm upon activating the Auxiliary channel.
- The Auxiliary Channel cannot be activated if the vehicle's ignition is "On".

Remote Anti-Carjack

The Anti-Carjacking mode can be activated using the remote control.

- *Refer to next page for sequence details.* (Programmable Dip-Switch #7)

To Activate Remote Anti-Carjack:

Press & Hold The "4th" Button, For 3 Seconds, With The Ignition "On".

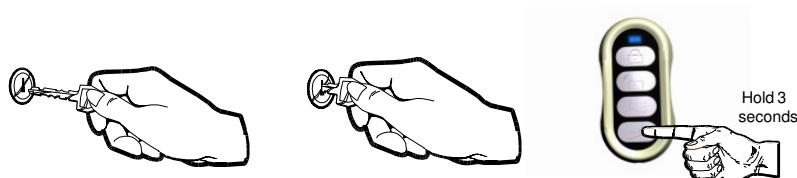

Programmable Anti-Carjacking Protection

The Anti-Carjacking sequence may be activated by any of 3 methods:

- 1) Using the remote control, by holding down the Small "4th" Button for 3 seconds while the ignition is "On". (*Dip-switch # 7*)
- 2) When a door is Opened while the ignition is "On" (*Dip-switch # 7*)
- 3) Every time the ignition is turned "On". (*Dip-switch # 6*)

1) Anti-Carjacking activated using the transmitter: (*Dip-Switch #7*)

The Anti Car-Jacking operation may be activated by pressing and holding the remote control's Small "4th" button for 3 seconds while the ignition is "On".

2) Anti-Carjacking activated by an Open door: (*Dip-Switch #7*)

If *Dip-switch #7* is set to "On", the system will initiate the Anti-Carjacking sequence every time a vehicle door is opened while the ignition is "On".

3) Anti-Carjacking activated by the ignition: (*Dip-Switch #6*)

If *Dip-switch #6* is set to "On", the system will initiate the Anti-Carjacking sequence every time the vehicle's ignition is turned "On".

Once the Anti-Carjacking sequence has begun, the user has 59 seconds to press the Valet/Override Switch in order to cancel the sequence.

ORDER OF ANTI-CARJACKING SEQUENCE:

- For first 20 seconds after the sequence has begun there are no signs.
- From 21-30 seconds, the LED will blink slowly.
- From 31-45 seconds, the LED will blink fast and the siren/horn will chirp once every 2 seconds.
- From 46-60 seconds, the LED will blink fast and the siren/horn will chirp once per second.
- If not cancelled yet, at 61 seconds the alarm will trigger.

In the triggered condition:

- The siren/horn will sound & The parking lights will flash.
- After 10 seconds, the starter interrupt will engage.

NOTE: Once the Anti-Carjack mode is triggered, the remote control will NOT stop the operation, nor will the system reset automatically. **Once it is triggered, the Anti-Carjacking operation can only be deactivated by:**

- 1) Turning the vehicle's ignition "Off".
- 2) Turning the vehicle's ignition back "On".
- 3) Within 10 seconds, Press & Release the Valet button.

Valet Mode

Valet Mode can only be entered into while the alarm is Disarmed.

Valet Mode turns off all of the alarm's security features, (including Anti-Carjack). Valet Mode is designed for situations in which it is not convenient for the security portion of the alarm to be operational; for example during extended stopovers for vehicle servicing, loaning others your vehicle, maintenance, valet parking, washing, etc. The convenience features such as keyless entry will still operate.

To Enter Valet Mode (Alarm MUST be Disarmed):

Press & Hold the Valet Switch for 3 Seconds.

- The LED Status Indicator will light solid Blue and the siren will emit a long chirp to confirm entry into Valet Mode. Now the system cannot become Armed.
- The vehicle's ignition may be "On" or "Off" when entering Valet Mode.
- *To remind you its in Valet Mode ,The siren will chirp every time the vehicle's ignition is turned "Off"*

To Exit Valet Mode: Simply Press & Release the Valet Switch.

- The LED will turn off and the siren will emit a long chirp to confirm that the system has exited Valet Mode. Normal arming operations may be resumed.
- The vehicle's ignition may be "On" or "Off" when exiting Valet Mode.

The LED Status Indicator

The Blue LED Status Indicator visually shows the status of the alarm and also provides a high level of visual deterrence. The Blue LED Status Indicator Light is normally mounted where it can be seen by the driver, as well as from outside.

Security System Status: The primary function of the Blue LED Status Indicator Light is to indicate the normal operating status of the security system:

Off = The system is disarmed and not performing any automatic functions.

On Constant = The system is in the Valet Mode.

Flashing Slow = The system is fully Armed.

Flashing Fast (while Disarmed) = Last Door Arming or Automatic Rearming.

Zone Violation: Once the alarm is Disarmed, the LED will show which zone triggered the alarm, until the ignition is turned "On" (this clears unit's memory).

3 flash & pause = Door zone triggered alarm.

4 flash & pause = Sensor zone triggered alarm.

Automatic Transmitter Verification: For the first 10 seconds after the vehicle's ignition is turned "On", the LED Status Indicator will flash a number of times equal to the number of remote control transmitters which are programmed to operate the alarm. This indication can be from 1 Flash /pause up to 4 Flashes /pause, as the system can be operated by just one, or as many as 4 remote transmitters.

Auxiliary Sensor & Prewarning

Auxiliary Sensor: This security system is equipped with an *On-Board* dual zone shock sensor that can be turned On/Off via programmable Dip-Switch #1, as well as a plug-in port for an optional sensor to increase the effectiveness of the system.

The comprehensive line of optional sensors offered is comprised of impact sensors, glass tampering sensors, and microwave/radar sensors which can detect motion inside and outside the vehicle.

Prewarning Detection: This circuit requires connection to a dual zone sensor or detection device. When the sensor's prewarn zone is triggered the siren will emit a series of chirps.

How to Program Remote Controls to the Alarm

To program remote controls to operate the alarm:

Step 1: Turn "On" the vehicle's ignition.

Step 2: Within 7 seconds press the Valet/Override Switch 5 times. The alarm will woff the siren once to confirm entry into Remote Control Programming Mode.

Step 3: Within 10 seconds, press any Button on each remote to be programmed. The siren will chirp to confirm each time a remote has been programmed.

If 10 seconds expire without any programming activity, or if the vehicle's ignition is turned "Off", the system will automatically exit Remote Control Programming Mode. The siren will emit 2 long chirps to confirm exit.

NOTE: Up to 4 remote controls can be programmed to operate the alarm. Whenever a remote control, new or existing, is programmed to the alarm, all existing codes are erased for security. So all remote controls which are to operate the alarm, must be programmed in at the same time.

ATV (Automatic Transmitter Verification)

ATV: The LED Status Indicator will show the number of programmed remote control transmitters for 10 seconds after the vehicle's ignition is turned On.

As the instructions above show, programming extra transmitters to any vehicle security system is easy; the exclusive patented ATV feature protects against someone programming their own transmitter to operate your system.

Programmable Features

The alarm has 8 programmable features which allow it to be customized by selecting the position of "Dip Switches" to suite many individual needs. The following pages provide a brief explanation for each feature, and notes its factory default setting.

Picture of Dip Switches



How to Program Features

To Program Features:

Step 1) Power down the alarm.

Step 2) Change the position of the Dip-Switches to desired settings.

Step 3) Power up the alarm.

• = Default Factory Setting

DIP SWITCH # 1: Internal Dual-Zone Shock Sensor

- Allows the user to turn the Internal Shock Sensor On/Off.

•Dip switch "On" = Sensor "On"

Dip switch Off = Sensor "Off"

DIP SWITCH # 2: Double Pulse Unlock:

- Sets the alarm to give 2 unlock pulses upon Disarm, for vehicles that require it.

Dip switch "On" = Double Unlock Pulses

•Dip switch Off = Single Unlock Pulse

• = **Default Factory Setting**

DIP SWITCH # 3: Last Door Arming & Locking:

- Configures the alarm to automatically arm itself & lock the vehicle doors (if vehicle is properly equipped), 30 seconds after the last door is closed with the vehicle's ignition "Off".

- Dip switch "On" = Last door arming "On"
- Dip switch Off = Last door arming "Off"

DIP SWITCH # 4: Auto-Rearm:

- Allows the Alarm to Rearm itself, if it is Disarmed and a vehicle door is not opened. The Rearm countdown is cancelled if a vehicle door is opened.

- Dip switch "On" = Auto-rearm "On"
- Dip switch Off = Auto-rearm "Off"

DIP SWITCH # 5: Siren & Horn or Horn Only:

- This feature configures the alarm's Brown/White Horn-Honk output wire. This wire can be configured to honk the horn in addition to the Brown wire operating the siren, **or take over all of the Siren's functions SO THAT NO SIREN IS NECESSARY.**

- **If Siren & Horn are selected:** The horn will honk, in addition to siren sounding, only when the door zone is violated. (The horn will not honk if the alarm is triggered by the sensor zone, or during confirmation "chirps")

- **If Only Horn is selected:** The car horn will replace the siren and perform all of its functions. **NOTE:** The Brown Siren wire will still be fully active & operational.

- Dip switch "On" = Siren/Horn
- Dip switch Off = Horn Only

DIP SWITCH # 6: Ignition Activated Anti-Carjacking:

- This feature turns the alarm's Ignition Anti-Carjacking feature "On" or "Off".

- Dip switch "On" = Ignition Hijack On
- Dip switch Off = Ignition Hijack Off

DIP SWITCH # 7: Remote Control & Open Door Activated Anti-Carjacking:

- This feature turns both the alarm's Remote Control and Open Door activated Anti-Carjacking features "On" or "Off".

- Dip switch "On" = Hijack On
- Dip switch Off = Hijack Off

• = Default Factory Setting

DIP SWITCH # 8: Ignition Door Lock/Unlock:

- Configures the alarm to Lock the vehicle's doors when the ignition is turned "On" and Unlock the vehicle's doors when the ignition is turned "Off".

•Dip switch "On" = Ignition door lock/unlock is "On"

Dip switch Off = Ignition door lock/unlock is "Off"

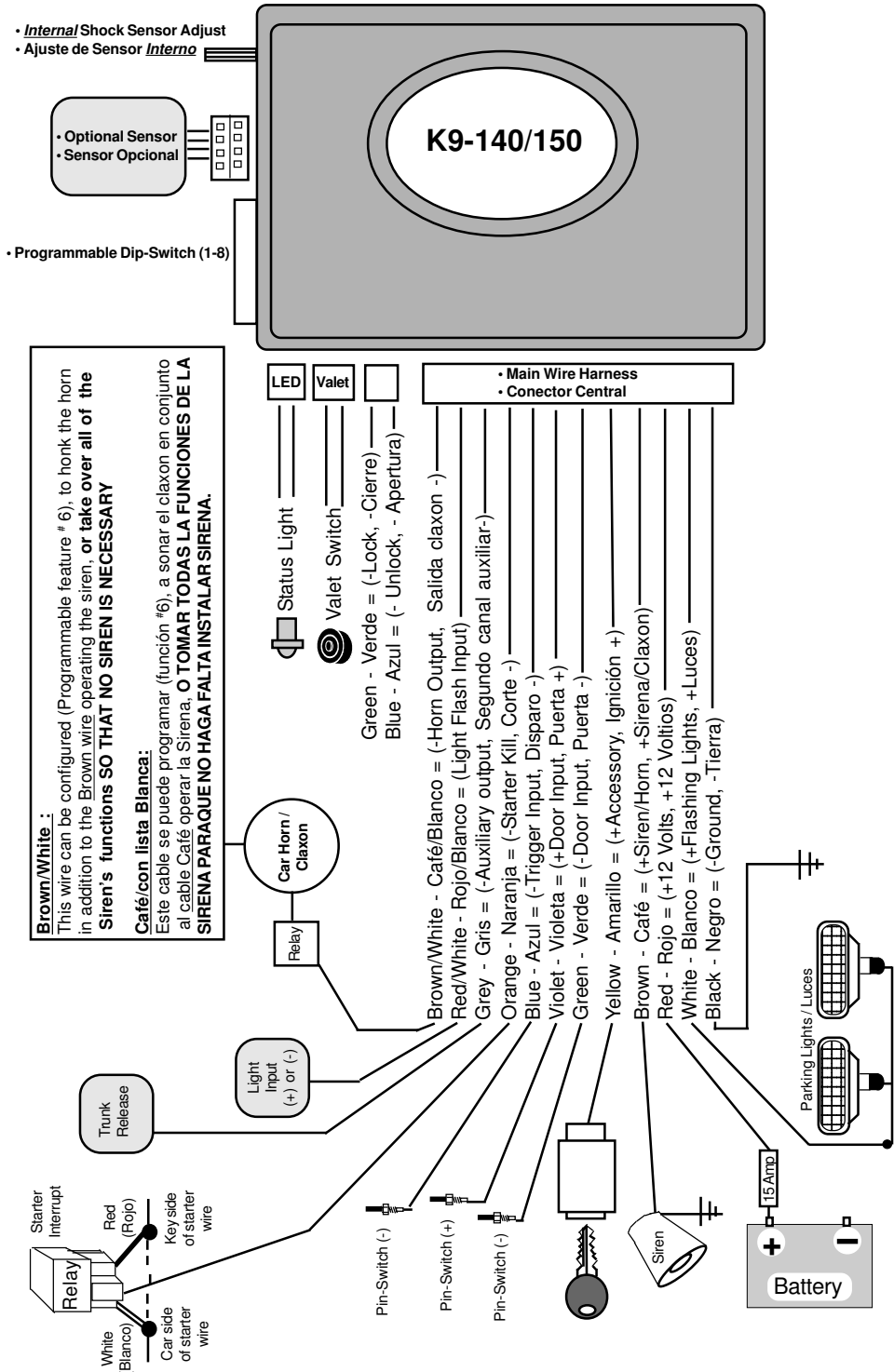

Door Locking Systems / Sistemas De Cierre

Negative Trigger System / Sistema Negativo:

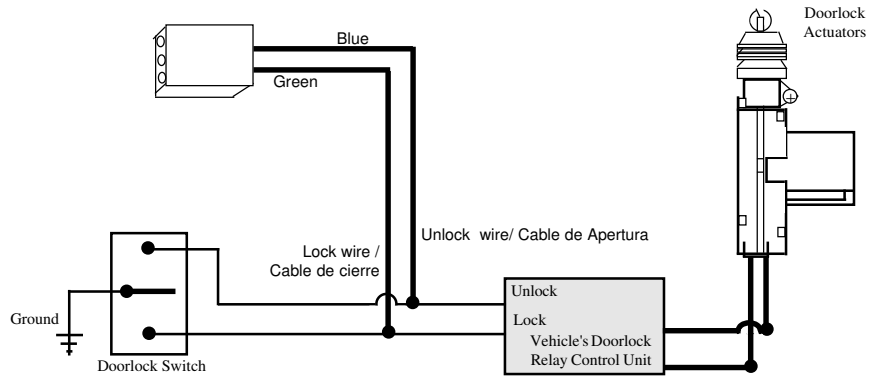

Positive Trigger System / Sistema Positivo:

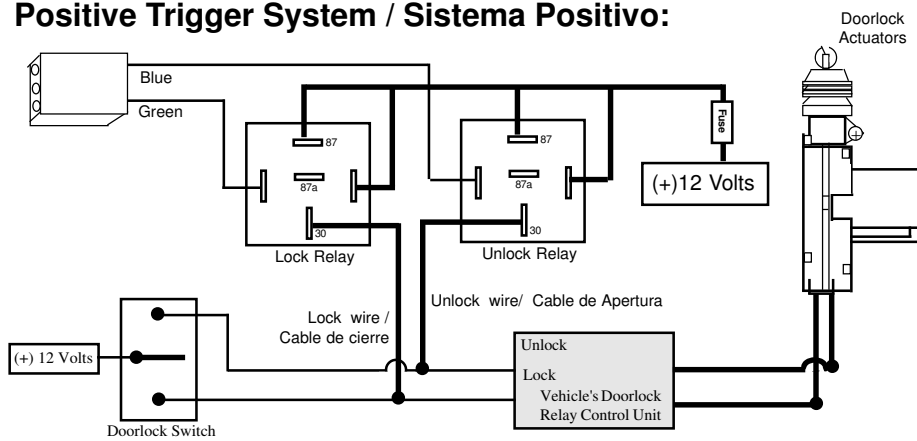

5 Wire Reversal (Rest at ground): Cambio de Polaridad:

