

# Contents

|  |           |
|--|-----------|
| <b>FCC Requirements .....</b>                        | <b>4</b>  |
| Federal Communications Commission Regulations.....   | 6         |
| Compliance with RF Exposure Standards.....           | 6         |
| Industry Canada Compliance .....                     | 6         |
| RF Exposure Compliance and Control Guidelines .....  | 7         |
| <b>Radio Controls.....</b>                           | <b>9</b>  |
| <b>LCD Display .....</b>                             | <b>10</b> |
| Status Indicators .....                              | 10        |
| Alphanumeric Label Options.....                      | 10        |
| Buttons and Labels .....                             | 11        |
| <b>Battery Installation and Removal.....</b>         | <b>12</b> |
| Installing the Battery .....                         | 12        |
| Removing the Battery .....                           | 12        |
| <b>Battery Care and Maintenance .....</b>            | <b>13</b> |
| <b>Antenna Installation and Removal.....</b>         | <b>13</b> |
| Installing the Antenna .....                         | 13        |
| Removing the Antenna .....                           | 13        |
| <b>Programmable Switch and Button Functions.....</b> | <b>14</b> |
| Switch Options.....                                  | 14        |
| Buttons Options .....                                | 14        |
| Menu Options.....                                    | 14        |
| Keypad Menu Operation .....                          | 15        |
| <b>Basic Radio Operation .....</b>                   | <b>16</b> |
| Receive .....  | 16        |
| Transmit .....                                       | 16        |
| <b>Code Guard Operation .....</b>                    | <b>17</b> |
| Analog Squelch Control.....                          | 17        |
| APCO Project 25 Squelch Control.....                 | 17        |
| Code Guard Receive .....                             | 18        |
| Code Guard Transmit.....                             | 18        |

|   |           |
|---|-----------|
| <b>Mixed Mode Operation .....</b>         | <b>19</b> |
| Mixed Mode Talkback .....                 | 19        |
| <b>Encryption Operation.....</b>          | <b>20</b> |
| Required Setup .....                      | 20        |
| Operation .....                           | 20        |
| Transmit Encryption Key Selection .....   | 21        |
| <b>General Options.....</b>               | <b>22</b> |
| Backlight (LIGT).....                     | 22        |
| Contrast .....                            | 22        |
| Keypad Lock .....                         | 23        |
| Monitor (MON).....                        | 23        |
| Repeater Talkaround (TA).....             | 23        |
| Surveillance Mode (SLNT).....             | 24        |
| Squelch Adjust (SQL) .....                | 24        |
| Test System (TEST).....                   | 24        |
| Tx Digital (TXD).....                     | 25        |
| Tx Power (LPW).....                       | 25        |
| Version (VER).....                        | 26        |
| Zone Select (ZON).....                    | 26        |
| <b>Scan Operation Options .....</b>       | <b>27</b> |
| Channel Scan (SCAN).....                  | 27        |
| Scanning Code Guarded Channels.....       | 27        |
| Transmitting with Scan On .....           | 28        |
| Talkback Scan.....                        | 28        |
| Priority Scan (PSCN).....                 | 28        |
| Scan List Add/Delete .....                | 30        |
| Zone Scan (ZSCN) .....                    | 31        |
| Zone Scan List Add/Delete .....           | 31        |
| <b>Emergency Signalling Options .....</b> | <b>32</b> |
| Placing an Emergency Call .....           | 32        |
| Receiving an Emergency Signal.....        | 32        |
| <b>Unit-to-Unit Call Options.....</b>     | <b>33</b> |
| Unit Call (U2U).....                      | 33        |
| Unit-to Unit Callback .....               | 34        |
| Call List Programming.....                | 34        |

|  |           |
|--|-----------|
| <b>Encryption Options .....</b>                        | <b>34</b> |
| Tx Secure (TXS) .....                                  | 34        |
| Zeroize Keys (ZER) .....                               | 35        |
| <b>Pick List Options .....</b>                         | <b>36</b> |
| Picklist- TX CxCSS (UTON) .....                        | 36        |
| Picklist – TX NAC (UNAC).....                          | 37        |
| Picklist – TGID (UTG) .....                            | 38        |
| Picklist – Key (UKEY) .....                            | 39        |
| Programming P25 ID Unit Call/Receive List.....         | 40        |
| Programming User Selectable Transmit Tones .....       | 42        |
| Programming User Selectable Network Access Codes ..... | 44        |
| Programming User Selectable Talkgroup IDs.....         | 45        |
| <b>Keypad Programming .....</b>                        | <b>46</b> |
| Programming Channel Information.....                   | 46        |
| Programming Zone Information .....                     | 55        |
| Programming Global Information.....                    | 59        |
| <b>Radio Cloning .....</b>                             | <b>64</b> |
| <b>Warranty.....</b>                                   | <b>66</b> |
| <b>Service.....</b>                                    | <b>66</b> |
| <b>Definitions and Acronyms .....</b>                  | <b>67</b> |
| <b>Your Radio Settings .....</b>                       | <b>68</b> |

---

## Introduction

---

Congratulations on your purchase of the BK Radio KNG Portable radio from RELM Wireless.

The KNG APCO Project 25 radio offers an array of programmable functionality to help radio users get the most out of their portable communications. Check with your RELM/BK Radio dealer or communications officer for information on the programmed functions of your radio prior to operation.

This manual contains information concerning the operation procedures for the BK Radio KNG Portable radio. The KNG has been designed to meet the tough requirements of today's communications environment. Please take a moment to read the information in this manual so you can get optimum performance from your new radio.

---

## FCC Requirements

---

Your radio must be properly licensed by the Federal Communications Commission prior to use. Your BK Radio dealer can assist you in meeting these requirements. Your dealer will program each radio with your authorized frequencies, signaling codes, etc., and will be there to meet your communications needs as your system expands.

---

## Safety Precautions

---



- Do not operate the transmitter in close proximity to blasting caps.
- Do not operate the radio in an explosive atmosphere (petroleum fuels, solvents, dust, etc.) unless your radio is an intrinsically safe model designed for such use.

---

## RF ENERGY EXPOSURE AWARENESS AND CONTROL INFORMATION, AND OPERATIONAL INSTRUCTIONS FOR FCC OCCUPATIONAL USE REQUIREMENTS

---

**BEFORE USING YOUR PORTABLE 2-WAY RADIO, READ THIS IMPORTANT RF ENERGY AWARENESS AND CONTROL INFORMATION AND OPERATIONAL INSTRUCTIONS TO ENSURE COMPLIANCE WITH THE FCC'S RF EXPOSURE GUIDELINES.**

**NOTICE: This radio is intended for use in occupational/controlled conditions, where users have full knowledge of their exposure and can exercise control over their exposure to meet FCC limits. This radio device is NOT authorized for general population, consumer, or any other use.**

This 2-way radio uses electromagnetic energy in the radio frequency (RF) spectrum to provide communications between two or more users over a distance. It uses radio frequency (RF) energy or radio waves to send and receive calls. RF energy is one form of electromagnetic energy; other forms include electric power, radar, sunlight and x-rays. RF energy, however, should not be confused with these other forms of electromagnetic energy, which when used improperly can cause biological damage. Very high levels of x-rays, for example, can damage tissues and genetic material. The energy levels associated with radio waves from portable 2-way radios, when properly used, are not great enough to cause biological damage.

Experts in science, engineering, medicine, health and industry work with organizations to develop standards for exposure to RF energy. These standards provide recommended levels of RF exposure for both workers and the general public. These recommended RF exposure levels include substantial margins of protection. All 2-way radios marketed in North America are designed, manufactured and tested to ensure they meet government established RF exposure levels. In addition, manufacturers also recommend specific operating instructions to users of 2-way radios.

These instructions are important because they inform users about RF energy exposure and provide simple procedures on how to control it. Please refer to the following websites for more information on what RF energy exposure is and how to control your exposure to assure compliance with established RF exposure limits.

<http://www.fcc.gov/oet/rfsafety/rf-faqs.html>

<http://www.osha.gov/SLTC/radiofrequencyradiation/index.html>

## FEDERAL COMMUNICATIONS COMMISSION REGULATIONS

The FCC rules require manufacturers to comply with the FCC RF energy exposure limits for portable 2-way radios before they can be marketed in the U.S. When 2-way radios are used as a consequence of employment, the FCC requires users to be fully aware of and able to control their exposure to meet occupational requirements. Exposure awareness can be facilitated by the use of a product label directing users to specific user awareness information. Your BK Radio 2-way radio has a RF exposure product label. Also, your BK Radio owner's and service manuals include information and operating instructions required to control your RF exposure and to satisfy compliance requirements.

## COMPLIANCE WITH RF EXPOSURE STANDARDS

Your BK Radio 2-way radio is designed and tested to comply with a number of national and international standards and guidelines (listed below) for human exposure to radio frequency electromagnetic energy. This radio complies with the IEEE and ICNIRP exposure limits for occupational/controlled RF exposure environment at operating duty factors of up to 50% transmitting and is authorized by the FCC for occupational use only. In terms of measuring RF energy for compliance with the FCC exposure guidelines, your radio radiates measurable RF energy only while it is transmitting (during talking), not when it is receiving (listening) or in Standby Mode. Note: The approved batteries supplied with this radio are rated for a 5-5-90 duty factor (5% talk - 5% listen - 90% standby), even though this radio complies with the FCC occupational RF exposure limits and may operate at duty factors of up to 50% talk.

Your BK Radio 2-way radio complies with the following RF energy exposure standards and guidelines:

- United States Federal Communications Commission, Code of Federal Regulations; 47 CFR §§ 1.1307, 1.1310, 2.1091 and 2.1093
- American National Standards Institute (ANSI) / Institute of Electrical and Electronic Engineers (IEEE) C95.1-1992
- Institute of Electrical and Electronic Engineers (IEEE) C95.1-1999 Edition

## INDUSTRY CANADA COMPLIANCE

This Class B digital apparatus complies with Canadian ICES-003. Cet appareil numérique de la classe B est conforme à la norme NMB-003 Canada.

## RF EXPOSURE COMPLIANCE AND CONTROL GUIDELINES AND OPERATION INSTRUCTIONS

To control your exposure and ensure compliance with the occupational/controlled environment exposure limits always adhere to the following procedures.

Guidelines:

- Do not remove the RF Exposure Label from the device.
- User awareness instructions must accompany device when transferred to other users. Do not use this device if the operational requirements described herein are not met.

Operating Instructions:

Transmit no more than the rated duty factor of 50% of the time. To transmit (talk), push the Push-To-Talk (PTT) button. To receive calls, release the PTT button. Transmitting 50% of the time, or less, is important because this radio generates measurable RF energy exposure only when transmitting (in terms of measuring for standards compliance).

- Hold the radio in a vertical position in front of face with the microphone (and the other parts of the radio, including the antenna) at least one inch (2.5 cm) away from the nose. Keeping the radio at the proper distance is important because RF exposures decrease with distance from the antenna. Antenna should be kept away from eyes.
- When worn on the body, always place the radio in a BK Radio approved clip, holder, holster, case, or body harness for this product. Using approved body-worn accessories is important because the use of BK Radio or other manufacturer's non-approved accessories may result in exposure levels which exceed the FCC's occupational/controlled environment RF exposure limits.
- If you are not using a body-worn accessory and are not using the radio in the intended use position in front of the face, then ensure the antenna and the radio are kept at least one inch (2.5 cm) from the body when transmitting. Keeping the radio at the proper distance is important because RF exposures decrease with increasing distance from the antenna.
- Use only BK Radio approved supplied or replacement antennas, batteries, and accessories. Use of non-BK Radio approved antennas, batteries, and accessories may exceed the FCC RF exposure guidelines.

For a list of BK Radio approved accessories visit the following website: <http://www.relm.com>.

The AMBE® voice compression software included in this product is protected by intellectual property rights including patent rights, copyrights and trade secrets of Digital Voice Systems, Inc. The user of this software is explicitly prohibited from attempting to decompile, reverse engineer, or disassemble the object code, or in any other way convert the object code into a human-readable form. This software is licensed solely for use within this product. US Patent Nos. #6,912,495 B2, #5,870,405, #5,826,222, #5,754,974, #5,715,365, #5,701,390, #5,649,050, #5,630,011, #5,581,656, #5,517,511, #5,491,772, #5,247,579, #5,226,084, and #5,195,166.

## CONTACT INFORMATION

For additional information on exposure requirements or other information, visit website <http://www.relm.com>.

## Radio Controls

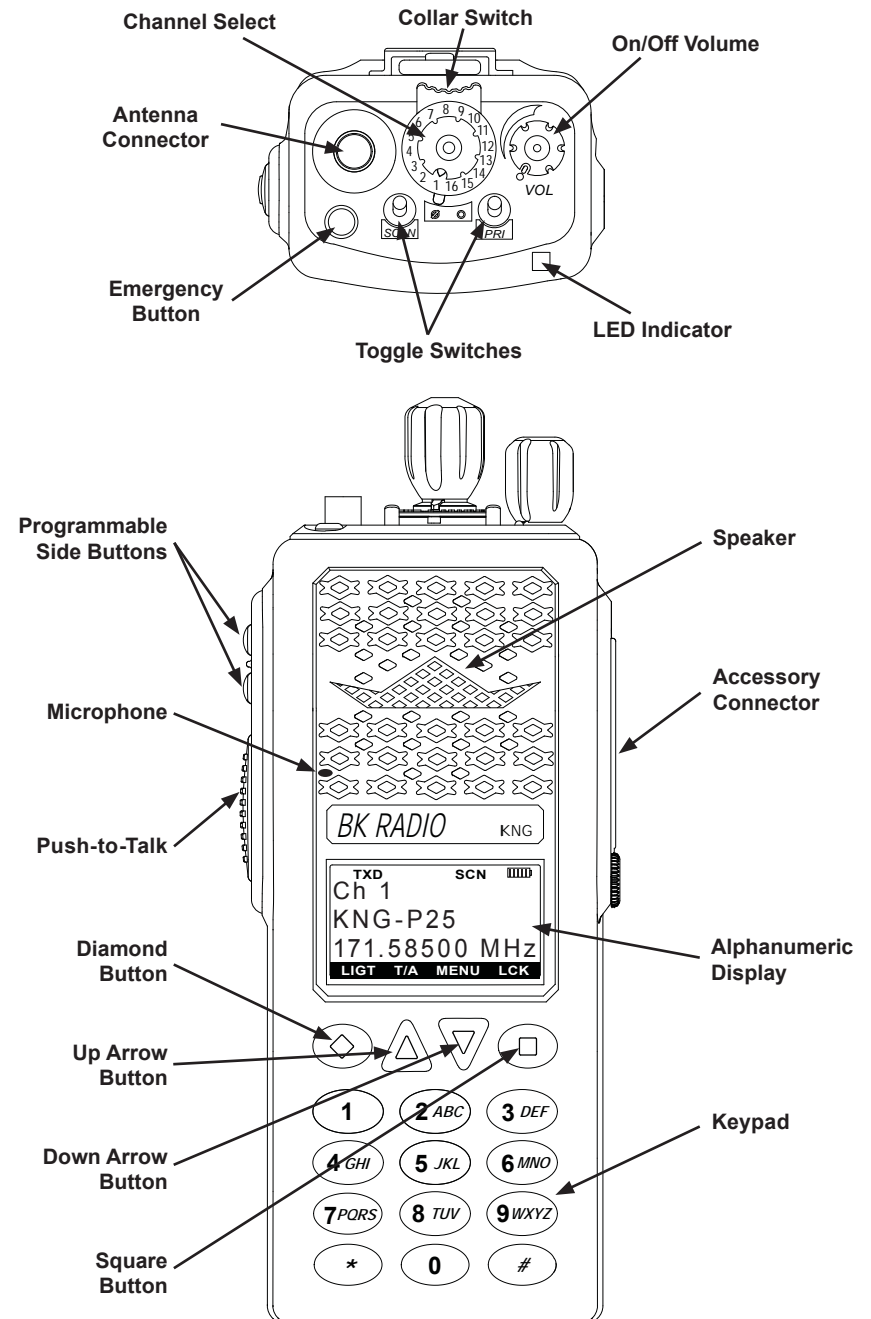

## LCD Display

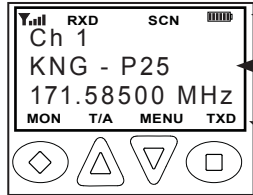

**Status Indicators**  
**Programmable Alphanumeric Labels**  
**Programmed Button Labels**

The KNG display can be programmed for a variety of options and functionality. Check with your RELM/BK Radio dealer or communications officer for information on the programmed functions of your radio.

### Status Indicators

|          |   |
|----------|---|
|          | Receiver Signal Strength                          |
| RXD, RXA | Receive Digital, Receive Analog, Hold Time Active |
| TXD, TXA | Transmit Digital, Transmit Analog                 |
| P1, P2   | Priority 1 Channel, Priority 2 Channel            |
| ∅, O     | Encrypted, Clear                                  |
| SCN      | Scan Channel, Flashing 'SCN' = Scan in Progress.  |
|          | Unit-to-Unit operation active                     |
|          | Battery Level Indicator                           |

### Alphanumeric Label Options

NOTE: Three channel information lines are programmable with PC Radio Editor Software.

|                        |  |
|------------------------|--|
| Channel Number         | Channel Number of Currently Selected Channel or Active Scanned Channel   |
| Channel Label          | Alphanumeric Label of Currently Selected Channel or Active Scanned Channel   |
| Frequency              | Operating Frequency of Currently Selected Channel or Active Scanned Channel  |
| Received Unit ID       | P25 ID of the radio transmitting the message currently being received<br>If the received ID is programmed in your radio's Call List, the corresponding label will be displayed |
| Received Talk Group ID | P25 Talk Group ID of the radio transmitting the message currently being received   |
| Pick List Selection    | NAC, TGID or Code Guard currently selected from the programmable Pick Lists  |
| Zone Label             | Label of Currently Selected Zone   |
| Zone and Channel       | Currently Selected Zone and Channel Numbers  |

### Buttons and Labels

NOTE: The Diamond, Up Arrow, Down Arrow, and Square buttons are programmable with PC Radio Editor Software. The programmed functions are activated by pressing the associated button. Active functions are indicated by a highlighted background. **SCN** = Active, **SCN** = Inactive.

|      |   |
|------|---|
| SCN  | Channel Scan  |
| PSCN | Priority Scan   |
| ZSCN | Zone Scan   |
| MENU | Open the programmed radio menu  |
| SQL  | Squelch Adjust  |
| BKLT | Keypad and Display Backlight  |
| T/A  | Repeater Talkaround   |
| LPW  | Low Transmit Power  |
| MON  | Monitor   |
| TXD  | Transmit Digital (Mixed Mode Operation)                                 |
| TXS  | Transmit Secure (Encrypted Models)                                      |
| U2U  | Unit-to-Unit Call (Digital Operation Only)                              |
| PRI  | Set Priority Channels   |
| UTON | User Selectable CTCSS/CDCSS Code Guard (Analog or Mixed Mode Operation) |
| UNAC | User Selectable NAC (Digital or Mixed Mode Operation)                   |
| UTG  | User Selectable Talk Group (Digital or Mixed Mode Operation)            |
| UKEY | User Selectable Encryption Key (Digital or Mixed Mode Operation)        |
| ZONE | Channel Zone Select   |
| SLNT | Surveillance Mode   |
| RKY  | Request OTAR Encryption Rekey (OTAR Encrypted Models)                   |
| ZER  | Zeroize Encryption Keys and Password (Encrypted Models)                 |
| TEST | Radio Test Mode (Used for radio service)                                |



---

## Battery Installation and Removal

---

NOTE: For safety reasons, rechargeable battery packs are shipped uncharged or only partially charged. Therefore, a rechargeable battery pack should be properly charged in an approved battery charger before use.

### Installing the Battery

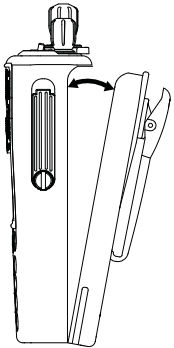

1. Turn the radio off.
2. Align the tabs on the bottom of the battery with the slots on the radio.
3. Push the top of the battery toward the radio until release tab "clicks" into place.

### Removing the Battery

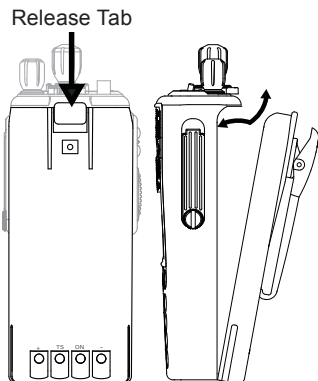

1. Slide the release tab toward the bottom of the radio.
2. Pull the top of the battery out. (Approximately 30°)
3. Pull up to remove the battery pack.

NOTE: All information programmed into the radio is maintained even when the battery pack is removed.

---

## Battery Care and Maintenance

---

BK Radio battery packs are available in a variety of capacities and types for special applications. Rechargeable battery packs can be charged separately or while attached to a radio.

Periodically check the contacts on the battery pack for dirt that could prevent a good electrical contact with the charging base.



### WARNING!

Do not drop a battery pack into fire.  
An explosion may occur

---

## Antenna Installation and Removal

---

NOTE: Transmitting without an antenna could result in damage to your radio.

Use RELM/BK Radio approved antennas only. Use of non-qualified or mismatched antennas could result in diminished radio operation. Published radio specifications cannot be guaranteed with non-approved antennas. Bent, broken or damaged antennas should be replaced.

### Installing the Antenna



Insert the radio's antenna connector into the threaded connector of the antenna and turn it clockwise until it is firmly seated.

### Removing the Antenna



Holding the base, turn the antenna counterclockwise until released.

## Programmable Switch and Button Functions

The KNG portable radio is equipped with seven programmable control buttons and three programmable switches. Switch and button functions are assigned via PC programming.

Collar Switch Right Toggle

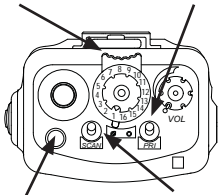

Orange Button Left Toggle

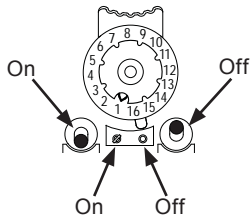

Side Buttons

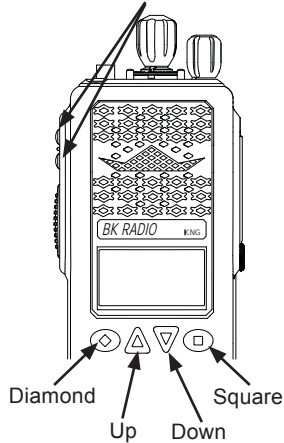

| Switch Options |               |           |
|----------------|---------------|-----------|
| Channel Scan   | Priority Scan | Zone Scan |
| Backlight      | Talkaround    | Tx Power  |
| Monitor        | Tx Digital    | Tx Secure |

| Buttons Options    |                     |                         |
|--------------------|---------------------|-------------------------|
| Channel Scan       | Priority Scan       | Contrast                |
| Zone Scan          | Menu                | Backlight               |
| Tx Power           | Monitor             | Tx Digital              |
| Tx Secure          | Unit Call           | Zeroize Keys            |
| Rekey Request      | Cloning             | Picklist-CxCSS          |
| Picklist-NAC       | Picklist-TGID       | Picklist-Key            |
| Picklist-Ket Set   | Zone Select         | Squelch Adjust          |
| PRI Channel Select | Repeater Talkaround | Surveillance Mode       |
| Version            | System Test         | Emergency (Orange Only) |

| Menu Options       |                     |                   |
|--------------------|---------------------|-------------------|
| Channel Scan       | Priority Scan       | Contrast          |
| Zone Scan          | Menu                | Backlight         |
| Tx Power           | Monitor             | Tx Digital        |
| Tx Secure          | Unit Call           | Zeroize Keys      |
| Rekey Request      | Cloning             | Picklist-CxCSS    |
| Picklist-NAC       | Picklist-TGID       | Picklist-Key      |
| Picklist-Ket Set   | Zone Select         | Squelch Adjust    |
| PRI Channel Select | Repeater Talkaround | Surveillance Mode |
| Version            | System Test         | Channel Scan List |
|                    | Zone Scan List      |                   |

**BKLT T/A MENU TXD** Functions assigned to the diamond, square or up/down buttons will be highlighted on the display when turned on.

**NOTE:** Functions programmed to the toggle or collar switches should not be programmed as menu items or button functions.

## Keypad Menu Operation

One button can be programmed as 'Menu'. Items shown in the previous table can be programmed and arranged via PC programming. These items can then be accessed with the 'Menu' button.

To select from the menu:

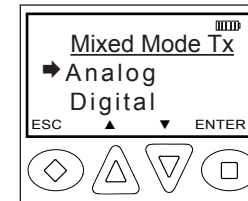
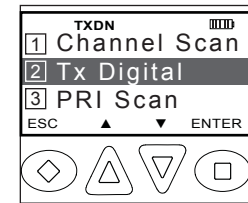

1. Press the programmed "Menu" button.
2. Scroll to the desired menu item using the up/down buttons or use the number keys to select the number of the desired function.
3. Press the square button marked 'ENTER' to open the selected item.
4. Use the up/down buttons to highlight the desired operation.
5. Press the square button marked 'ENTER' to set the selection.
6. Press and hold the diamond button marked 'ESC' to return to normal radio operation.



## Basic Radio Operation

### Receive

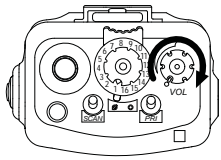

1. Turn power on by turning the Volume knob clockwise. A beep sounds, indicating the radio is operational. The LCD display shows the programmed information of the currently selected channel. Programmable channel information options include number, label, frequency and other channel information.

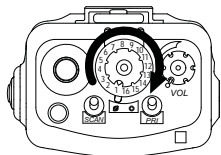

2. Select a channel by rotating the Channel Selector knob.

3. Open the squelch to adjust the volume

(Open squelch can be achieved by selecting the programmed Monitor function.)

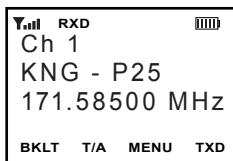

When a signal is received, the unprogrammable top line of the display indicates the current channel's operating mode. RXA = analog, RXD = digital.

### Transmit

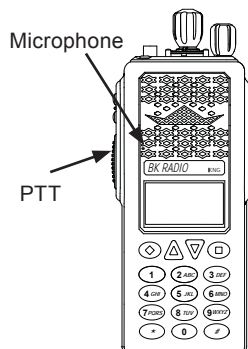

1. Press the PTT (Push-To-Talk) switch. When the radio is transmitting the indicator LED glows red and TXD or TXA appears in the display.

2. Talk in a normal voice with the microphone one to two inches from your mouth.

3. Release the PTT switch to stop transmitting.

If the length of your message exceeds the programmed Time-Out Timer setting, the transmitter automatically shuts off and a tone sounds. To continue transmission, release the PTT switch, then press it again and continue talking.

If the Transmit Indicator does not glow and a tone sounds, you are on a receive-only channel or the

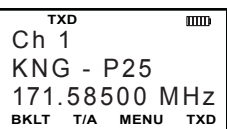

channel is busy (see Busy Channel Lockout). Select an authorized transmit channel.

NOTE: When using a channel programmed for mixed mode transmit the signal will be transmitted in the mode selected by the TX Digital selection. Or if programmed for Mixed Mode Talkback, the radio will transmit in the mode of the last received channel while the "RX" icon is displayed. (See Mixed Mode Operation.)

## Code Guard Operation

### Analog Squelch Control

Sub-audible signaling (CTCSS/CDCSS) is used to allow a group of radios to be selectively called in an analog system. Programming the receive code guard equal to zero allows for Carrier Squelch operation, where the radio will unmute whenever a carrier is detected regardless of the transmitted Code Guard.

### APCO Project 25 Squelch Control

Network Access Codes (NACs) provide the digital equivalent of analog sub-audible signaling (CTCSS/CDCSS) allowing a group of radios to be selectively called within a system.

Users in the same area (using the same NAC) can be further divided into Talk Groups, with each group having its own Talk Group ID (TGID). Group Calls are made by designating both the users' NAC and TGID.

Each radio also has an individual P25 unit ID. A Unit-to-Unit call contains the addressee's NAC, and uses the addressee's P25 unit ID instead of the TGID.

When operating in Digital Mode, each channel can be programmed to use either Normal squelch or Selective squelch.

**Normal squelch** is used to mimic analog operation. Signals are only qualified with the programmed NAC. TGIDs and P25 Unit IDs are ignored. Each digital channel is programmed with a receive NAC and a transmit NAC. When an incoming signal's NAC matches the channel's programmed receive NAC, the radio unmutes. The default NAC is 0659 (\$293 hex).

The digital equivalent of carrier squelch is achieved by programming the receive NAC = 3966(\$F7E hex). The radio will unmute when a digital signal with any NAC is detected. The 3966 (\$F7E hex) NAC is reserved for receivers and is not allowed as a transmit NAC.

**Selective squelch** is used for processing Group Calls and Unit-to-Unit Calls. TGIDs are assigned on a per-channel basis. Users can be separated into Talk Groups with each group having its own TGID. Then, on channels programmed for Selective squelch, the incoming signal's NAC and TGID must match the channels programmed receive NAC and TGID for the radio to unmute. The default TGID is 1.

The TGID value 65535 (\$FFFF hex) is used to effect an "All Call". If the radio receives a signal with a matching NAC and the TGID = 65535 (\$FFFF hex), it will unmute. Also, if the radio's programmed TGID is 65535 (\$FFFF hex), it will open on any signal with a matching NAC, ignoring the incoming TGID. A TGID = 0 means "no one". If the radio is programmed with the TGID = 0, it will accept incoming group calls containing the "All Call" TGID, and correctly addressed Unit-to-Unit calls only.

### Code Guard Receive

Analog channels programmed with a receive code guard will be heard only when the proper frequency and Code Guard value is received. Analog and mixed mode receive channels will also unmute when the radio is in monitor mode.

### Code Guard Transmit

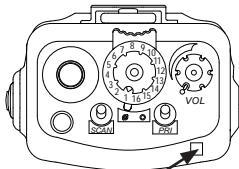

Busy Channel/Transmit Indicator

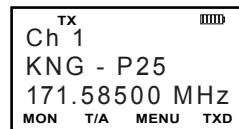

The frequency must be clear prior to transmitting on a Code Guarded channel. If the LED Indicator is yellow do not transmit. Busy Channel Lockout can be programmed to disallow transmitting while a channel is busy.

1. Press the PTT switch. When the transmitter is on, the LED Indicator glows red and TX appears in the display.
2. Talk in a normal voice with the microphone one to two inches from your mouth.
3. Release the PTT switch to stop transmitting.

## Mixed Mode Operation

The receiver and transmitter are capable of operating in analog wide-band (25 kHz channel spacing), analog narrow-band (12.5 kHz channel spacing) and APCO Project 25 Digital Mode.

Each channel's Receive and Transmit Mode can be set independently as follows:

| Mode           | RX  | TX   |
|----------------|---|--|
| <b>Analog</b>  | Receive qualified analog signals only                     | Transmit analog signals only   |
| <b>Digital</b> | Receive qualified digital signals only                    | Transmit digital signals only  |
| <b>Mixed</b>   | Automatically receive qualified analog or digital signals | Transmit analog or digital signal, depending on the status of 'TX Digital' soft switch |

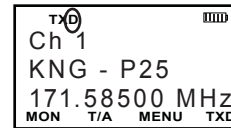

Digital receptions and transmissions will be indicated by illuminating the D annunciator in addition to the RX or TX annunciator.

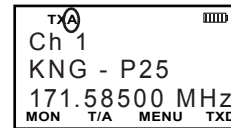

Analog receptions and transmissions will be indicated by illuminating the A annunciator in addition to the RX or TX annunciator.

### Mixed Mode Talkback

If Mixed Mode Talkback is enabled, transmissions initiated while hold time remains will be in the same mode as the received signal, if the signal was received on the Ready to Transmit (RTX) channel. Depending on programming, the RTX channel can be the main channel, a held scan or priority channel if Talkback Scan is enabled, or the Priority 1 channel if TX on PR1 is enabled. TX Mode on the RTX channel must be set to MIXED.

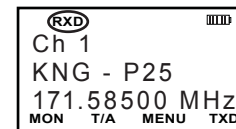

Press the PTT while the RX indicator is shown

While hold time after a reception remains, transmissions will be in the same mode as the received signal, regardless of the status of the TX Digital switch. As in Talkback Scan, the RTX channel and receive annunciators will be displayed for the duration of the timer.

---

## Encryption Operation

---

The radio may optionally be configured for Secure communication on channels operating in Digital Mode. No encryption is available for analog channels.

### Required Setup

Radios that have the DES/AES factory option for encryption must have encryption keys loaded with an APCO Project 25 compatible key fill device such as the Motorola KVL 3000 Plus, using a BK Radio keyloader cable. The radio can hold up to 32 AES and/or DES keys.

After loading keys in the radio, the KNG PC programming software must be used to configure the radio's key table and to assign default transmit keys to each channel.

Radios that have the OTAR factory option support Over-the-Air Rekeying of encryption keys (OTAR). The KNG PC programming software must be used to enable OTAR and to mark the channel(s) that will communicate with the Key Management Facility (KMF). In addition, the radio must have key encryption keys (used only to encrypt other keys) loaded with an APCO Project 25 compatible key fill device such as the Motorola KVL 3000 Plus, using a BK Radio keyloader cable.

### Operation

The receiver can be programmed to automatically detect both clear and secure signals.

The transmitter selects clear or secure operation based on each channel's programming. Digital channels can be programmed to always transmit encrypted, always transmit clear, or to select the encryption mode with the TX Secure switch.

The display indicates Secure Operation as follows:

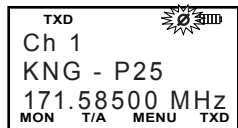

In Standby Mode, if the radio will transmit in Secure Mode when PTT is pressed, the encrypt icon flashes in the display.

When receiving or transmitting an encrypted signal, the encrypt icon flashes in the display.

## Transmit Encryption Key Selection

The radio can hold up to 32 DES or AES encryption keys. Each channel is assigned a default key for transmit. The key can be locked to the channel, or if programming allows, a transmit key other than the default key can be selected from the radio's Key Pick List. If a key is selected from the pick list, it will be used during transmit on every channel that allows selectable keys.

Follow the steps below to select the encryption key.

To use the channels programmed key:

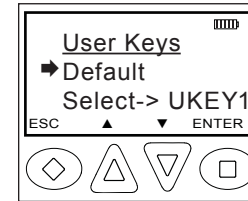

1. Press the button programmed for the Key Pick List (**UKEY**) or select 'TX KEYS' from the programmed menu.
2. Use the up/down buttons to highlight 'Default'.
3. Press the 'ENTER' button to select the key.
4. Hold the 'ESC' button to return to normal operation.

To select a key from the programmed list:

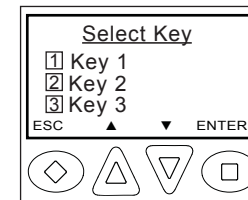
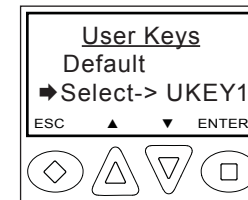

1. Press the button programmed for the Key Pick List (**UKEY**) or select 'TX KEYS' from the programmed menu.
2. Use the up/down buttons to highlight 'Select'.
3. Press the 'ENTER' button to open the key menu.
4. Use the up/down buttons to highlight the desired key. Or, using the keypad, press the number of the desired key.
5. Press the 'ENTER' button to select the key.
6. Hold the 'ESC' button to return to normal operation.

operation.

If a key is selected that has not been programmed, the radio will not

---

## General Options

---

### Backlight (LIGT)

When the Backlight function is programmed to a switch the display and keypad will illuminate when the switch is on.

If the backlight function is programmed to a button the display and keypad will illuminate for the programmed duration. (1-6 seconds or ON)

Toggle switch operation

On - Toggle the programmed switch toward the front of the radio.

Off - Toggle the switch up toward the channel select switch.

Button Operation

On - Press the programmed button. **BKLT**

Off - Press the button again. **BKLT**

Menu Operation

1. Select 'Backlight' from the programmed menu
2. Use the up/down buttons to select 'On' or 'Off'.
3. Press the 'ENTER' button to set the selection.
4. Hold the 'ESC' button to return to normal operation.

### Contrast

When the Contract function is enabled the contrast of the LCD display can be adjusted via the radio's keypad.

To adjust the contrast:

1. Press the button programmed for Contrast or select 'Contrast' from the programmed menu.
2. Use the up/down buttons to adjust the display for the desired contrast.
3. Press the 'ENTER' button to set the selection and return to normal operation or press the 'ESC' to abort.

### Keypad Lock

The Keypad Lock function can be programmed as a radio menu item. Enabling Keypad Lock locks the programmable buttons.

NOTE: Toggle and collar switches are not lockable.

Operation

1. Select 'Keypad Lock' from the programmed menu
2. Use the up/down buttons to select 'Unlocked' or 'Locked'.
3. Press the 'ENTER' button to set the selection and return to normal operation or press the 'ESC' button to abort the operation.

When a button is pressed while the keypad is locked a 'Keypad Locked' message will be displayed.

To unlock the keypad, press and hold any button.

### Monitor (MON)

When MON is on, the radio will unmute. The LCD display will show the receive indicator along with the signal strength indicator. If the channel is not in use the signal strength indicator will show no bars and you will hear white noise, sometimes called squelch noise.

Toggle switch operation:

On - Slide the programmed switch toward the front of the radio.

Off - Slide the switch up toward the channel select switch.

Button Operation:

On - Press the programmed button. **MON**

Off - Press the button again. **MON**

Menu Operation:

1. Select 'Talk Around' from the programmed menu
2. Use the up/down buttons to select 'Off' or 'On'.
3. Press the 'ENTER' button to set the selection.
4. Hold the 'ESC' button to return to normal operation.

### Repeater Talkaround (TA)

When TA is turned on the radio will transmit on the programmed receive frequency of the selected channel.

Toggle switch operation:

On - Slide the programmed switch toward the front of the radio.

Off - Slide the switch up toward the channel select switch.

Button Operation;

On - Press the programmed button. **T/A**

Off - Press the button again. **T/A**

Menu Operation:

1. Select 'Talk Around' from the programmed menu
2. Use the up/down buttons to select 'Repeater' or 'Direct'.
3. Press the 'ENTER' button to set the selection.
4. Hold the 'ESC' button to return to normal operation.

## Surveillance Mode (SLNT)

When SLNT is on, all audible indicators (button beeps etc.) and LEDs are disabled.

NOTE: If the Backlight option is enabled, keypad and display lights can still be switched on and off.

Operation:

1. Press the button programmed for Surveillance or select 'Surveillance Mode' from the programmed menu.
2. Use the up/down buttons to select "On" or "Off".
3. Press the 'ENTER' button to set the selection and return to normal operation or press the 'ESC' to abort.

## Squelch Adjust (SQL)

Squelch adjust can be assigned to the keypad or a radio menu item.

1. Press the button programmed for Squelch Adjust or select 'Squelch Adjust' from the programmed menu.
2. Use the up/down arrows to select the desired squelch point.
3. Press 'ENTER' to set the selection.
4. Hold the 'ESC' button to return to normal operation.

## Test System (TEST)

The Test System functions are used for radio service only. These functions should only be accessed by qualified technical personnel. Refer to the radio's service manual for information and operation of the Test System function.

## Tx Digital (TXD)

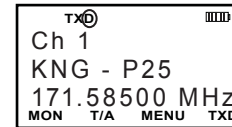

The display shows 'TXD' in the top left corner, indicating digital transmission mode. The rest of the display shows 'Ch 1', 'KNG - P25', '171.58500 MHz', and a status bar with 'MON', 'T/A', 'MENU', and 'TXD'.

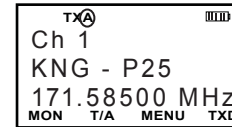

The display shows 'TXA' in the top left corner, indicating analog transmission mode. The rest of the display shows 'Ch 1', 'KNG - P25', '171.58500 MHz', and a status bar with 'MON', 'T/A', 'MENU', and 'TXD'.

When the TXD is on, channels programmed for mixed-mode transmit will transmit in digital mode. When off, mixed-mode channels transmit in analog mode. When transmitting in digital mode the display shows 'D' behind the TX indicator. In analog transmit 'A' will follow the indicator.

Toggle switch operation:

On - Slide the programmed switch toward the front of the radio.

Off - Slide the switch up toward the channel select switch.

Button Operation:

On - Press the programmed button. **TXD**

Off - Press the button again. **TXD**

Menu Operation:

1. Select 'TX Digital' from the programmed menu.
2. Use the up/down buttons to select 'Digital' or 'Analog'.
3. Press the 'ENTER' button to set the selection.
4. Hold the 'ESC' button to return to normal operation.

## Tx Power (LPW)

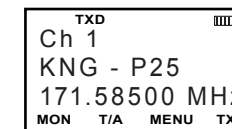

The display shows 'TXD' in the top left corner, indicating digital transmission mode. The rest of the display shows 'Ch 1', 'KNG - P25', '171.58500 MHz', and a status bar with 'MON', 'T/A', 'MENU', and 'TXD'.

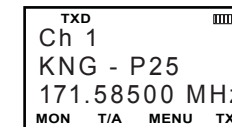

The display shows 'TXD' in the top left corner, indicating digital transmission mode. The rest of the display shows 'Ch 1', 'KNG - P25', '171.58500 MHz', and a status bar with 'MON', 'T/A', 'MENU', and 'TXD'.

If Tx Power selection is enabled, transmit power can be switched between the high power and the pre-programmed low power setting.

Toggle switch operation:

High - Slide the programmed switch toward the front of the radio.

Low - Slide the switch up toward the channel select switch.

Button Operation:

High - Press the programmed button. **LPW**

Low - Press the button again. **LPW**



### Menu Operation:

1. Select 'TX Power' from the programmed menu.
2. Use the up/down buttons to select 'High' or 'Low'.
3. Press the 'ENTER' button to set the selection.
4. Hold the 'ESC' button to return to normal operation.

### Version (VER)

The 'Version' functions provides information about the radio's firmware. Information on current firmware revisions may be found at [www.relm.com](http://www.relm.com). or from the RELM Wireless Service Department.

### Zone Select (ZON)

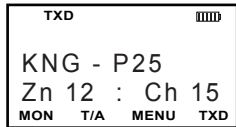
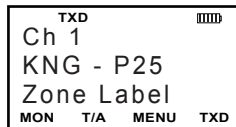

The 512 channels available in the KNG can be divided into multiple operating zones. Switching between zones is accomplished via a programmed button or menu item. Optionally, zone labels or numbers can be displayed on the LCD. (See Alphanumeric Label Options.)

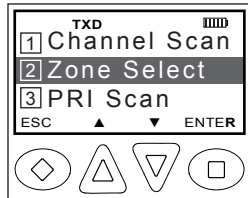

#### Operation:

1. Press the button programmed for 'Zone Select' or select 'Zone Select' from the programmed menu.
2. Use the up/down buttons to select the desired zone or use the number buttons to enter the desired zone number.
3. Press 'ENTER' to set the zone.
4. Hold the 'ESC' button to return to normal operation.

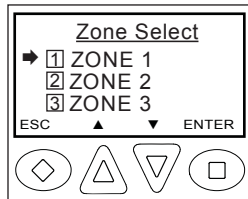

## Scan Operation Options

### Channel Scan (SCAN)

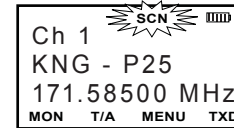

The display indicates scan operation by flashing SCAN.

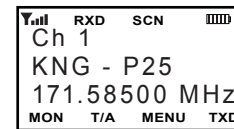

Scan operates only while the radio is not transmitting. The radio checks for signals on channels in the preset Scan List, as well as the channel selected by the Channel Selector knob.

When a signal is detected, scanning stops and the message is received. The received channel is shown in place of the selected channel.

Once the signal ends, the radio continues to monitor the channel for the preset scan delay time before it resumes scanning.

#### Toggle switch operation:

- On - Slide the programmed switch toward the front of the radio.
- Off - Slide the switch up toward the channel select switch.

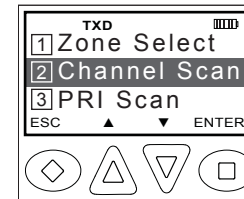

#### Button Operation:

- On - Press the programmed button. **SCAN**
- Off - Press the button again. **SCAN**

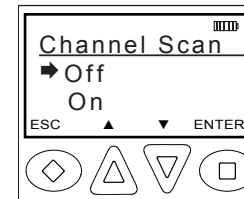

#### Menu Operation:

1. Select 'Scan' from the programmed menu.
2. Use the up/down buttons to select 'On' of 'Off'.
3. Press the 'ENTER' button to set the selection.
4. Hold the 'ESC' button to return to normal operation.

### Scanning Code Guarded Channels

When a signal is detected, scanning stops while the radio checks for the proper Channel Guard value. If the signal contains the proper Channel Guard value, the radio receives the message. Otherwise, the radio resumes scanning immediately.



## Transmitting with Scan On

The radio transmits on the channel selected by the Channel Selector knob unless Talkback Scan is enabled (see Talkback Scan) or Transmit on Priority 1 is enabled (see Priority Scan).

When the PTT switch is released, the radio continues to monitor the selected channel for the preset scan delay time before it resumes scanning.

## Talkback Scan

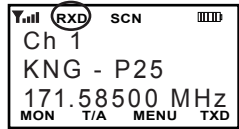

If your radio is programmed for Talkback Scan, press PTT while a channel is active or while scan delay time remains, you will be responding on the transmit frequency of the received channel. The 'RX' indicator will be shown in the display while scan delay time remains.

Talkback Scan will not work if Priority Scan is on and your radio is also programmed for Transmit on Priority (see Priority Scan).

## Priority Scan (PSCN)

Priority Scan enables the radio to receive on any channel while monitoring for a message on the designated priority channel(s). The radio samples each priority channel at a preset rate (.25-2.0 seconds) regardless of activity on any other channel. Priority Scan operates only while the radio is not transmitting and can be used in combination with scan operation.

Up to two priority channels can be programmed on a radio wide (Global) or per-zone basis, programmable via PC. When Global Priority channels are enabled, zone priority selections are disabled.

If priority channels are assigned on a per-zone basis, the radio monitors the priority channels in the currently selected zone. If priority channels are programmed on a Global basis the radio will monitor the assigned channels regardless of the currently selected zone.

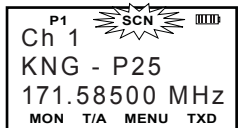

When Priority Scan is on, the display flashes SCN. If a message is received on a priority channel, the Priority Indicator appears, and the radio receiver locks onto that channel for the duration of the transmission, unless a higher priority channel interrupts.

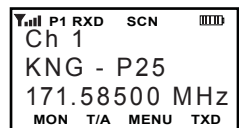

The two channels, designated as PR1 and PR2, are periodically sampled for activity, even if a different transmission is being monitored. Activity on PR2 preempts activity on any of the non-priority channels. Receptions on PR1 have priority over any other channel, including PR2.

Either priority channel can be programmed as a fixed channel, tied to the Channel Selector knob, or programmed OFF. If the radio is programmed to transmit on PR1, transmissions will occur on the first priority channel when operating in Priority Scan Mode.

Priority Scan can be used in combination with Code Guard. If a message is received on a priority channel, the radio receiver locks on to the priority channel and checks to see if the proper Channel Guard value is present. If the signal contains the proper Channel Guard value, the radio receives the message. Otherwise, the radio will re-check the channel every 4 seconds, until the activity on the channel ceases.

If enabled the user can use the keypad to change the priority channels. The Priority Channel selection can be programmed to a programmed button or as a menu item.

**NOTE: To use Zone based Priority Channels set both Global Priority Channel 1 and 2 to 'OFF'.**

## To select a new Zone Priority Channel:

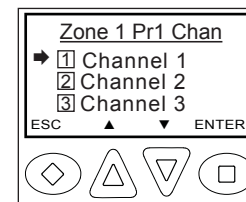
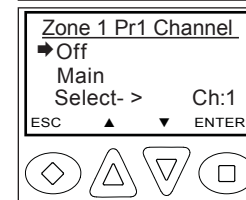
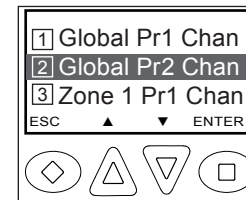

1. Press the button programmed for "PRI" or select 'Priority Channels' from the programmed menu.
2. Use the up/down buttons to select the priority channel you wish to edit. 'Zone # Pr1 Channel' 'Zone # Pr2 Channel'
3. The arrow indicates the current setting. Use the up/down buttons to select 'Off', 'Main' to use the knob selected channel as the priority channel or 'Select' to assign a new channel. If 'Select' is chosen you will be prompted to select the desired Priority channel.
4. Press 'ENTER' to set the selection.
5. Hold the 'ESC' button to return to normal radio operation

### To select a new Global Priority Channel:

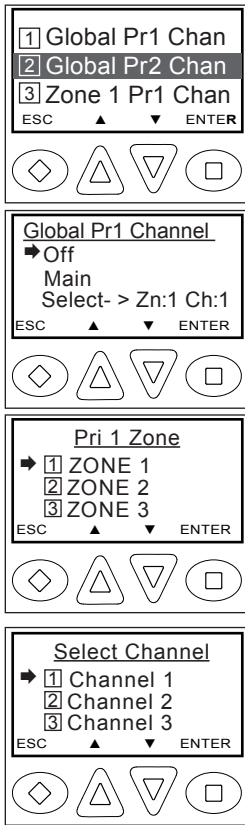

1. Press the button programmed for "PRI" or select 'Priority Channels' from the programmed menu.
2. Use the up/down buttons to select the priority channel you wish to edit. 'Glob PR1 Channel' 'Glob PR2 Channel'
3. The arrow indicates the current setting. Use the up/down buttons to select 'Off', 'Main' to use the knob selected channel as the priority channel or 'Select' to assign a new channel. If 'Select' is chosen you will be prompted to select the zone and channel of the desired Global Priority channel.
4. Hold the 'ESC' button to return to normal radio operation

### Scan List Add/Delete

A menu item can be programmed to add or remove channels from the scan list. Channels currently in the scan list will show 'SCN' in the top line of the display.

To edit the Scan List:

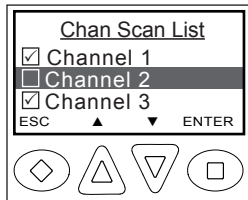

1. Select 'Scan List' from the programmed menu.
2. Use the up/down buttons to select the desired channel.
3. Toggle the 'ENTER' button to add or delete the channel from the Scan List.

Channels preceded by '✓' are currently in the scan list

4. Hold 'ESC' to return to normal radio operation.

### Zone Scan (ZSCN)

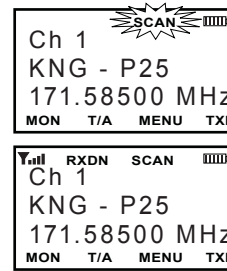

When Zone Scan is turned on, the radio scans all programmed scan channels in zones programmed as Zone Scan zones.

Toggle switch operation

On - Slide the programmed switch toward the front of the radio.

Off - Slide the switch up toward the channel select switch.

Button Operation

- On - Press the programmed button. **ZSCN**
- Off - Press the button again. **ZSCN**

Menu Operation

1. Press the assigned Menu button.
2. Use the up/down buttons to select 'Zone Scan'.
3. Press the 'ENTER' button.
4. Use the up/down buttons to select On or Off.
5. Press the 'ENTER' button to set the selection.
6. Hold the 'ESC' button to return to normal operation.

### Zone Scan List Add/Delete

A menu item can be programmed to add or remove Zones to the Zone Scan List.

To edit the Zone Scan List:

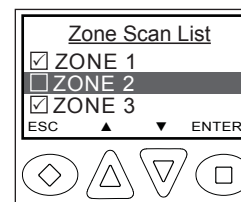

1. Select 'Scan List' from the programmed menu.
2. Use the up/down buttons to select the desired zone.
3. Toggle the 'ENTER' button to add or delete the zone from the Scan List. Zones preceded by '✓' are currently in the scan list
4. Hold 'ESC' to return to normal radio operation.

## Emergency Signalling Options

The KNG portable radio supports P25 Emergency Operation. When Emergency Operation is engaged the radio will transmit the P25 ID of the radio along with the required P25 Emergency bit. Emergency operation applies only to channels programmed for Digital or Mixed Mode transmissions.

On channels programmed for analog transmissions, pressing PTT in Emergency Mode will result in a normal analog transmission.

On channels programmed for Mixed Mode transmissions, pressing PTT will result in a digital transmission, regardless of the position of the 'TX Digital' switch.

*All scanning and priority functions will be disabled during Emergency operation.*

Depending on the radio's PC programmable settings, emergency signal will be sent automatically or with each Push-to-Talk.

### Placing an Emergency Call

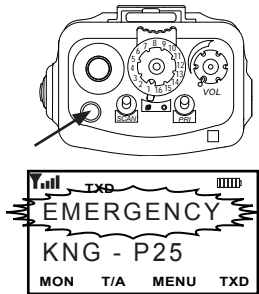

To place an emergency call, press and hold the programmed emergency button until the radio beeps and the display flashes "EMERGENCY".

Radio automatically sends the emergency signal on the selected or pre-programmed emergency channel.

Cycle power to return the radio to normal operation.

### Receiving an Emergency Signal



To receive an emergency call, the radio's receive mode must be programmed to Digital or Mixed.

When receiving a qualified emergency call, the radio will beep. The the display will flash the word 'EMERGENCY' and the P25 ID of the radio sending the signal for the duration of the reception, and during any hold time. The RXD icon will also be lit.

## Unit-to-Unit Call Options

### Unit Call (U2U)

P25 Unit IDs allow for Unit-To-Unit calls when the radio is operating in Digital Mode. The function must be enabled by radio programming to allow this mode of operation.

Channels programmed for analog only operation will not be able to transmit or receive Unit-To-Unit calls.

### Sending a Unit Call

1. Press the button programmed for 'U2U' or select 'Unit Call' form the programmed menu.

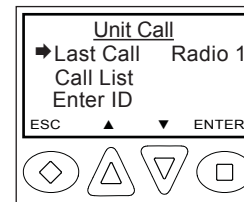

2. Use the up/down buttons to select the desired Unit 'Call' option.

*Last Call* = Use the P25 ID of the last Call. 'ENTER' initiates call.

*Call List* = Use the programmed P25 ID List.

'ENTER' brings up programmed Call List.

Use the up/down button to select the desired ID.

Press 'ENTER' to initiate the call.

*Enter ID* = Enter a numeric P25 ID.

'ENTER' brings up 'Enter ID' menu.

Use the keypad to enter the desired ID.

Press 'ENTER' to initiate the call.

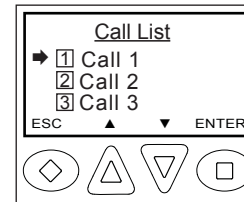

Select From List

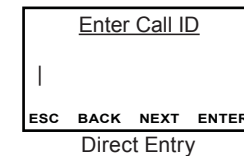

Direct Entry

3. The selected P25 ID and the telephone icon will be shown on the LCD display. If the P25 in use matches a programmed ID in the Call List, the label associated with the ID will be displayed. (See Call List Programming)

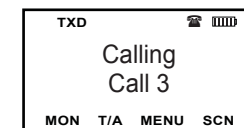

4. Press the 'PTT' button to send the unit-to-unit call. Unit Call information will be sent with each Push-to-Talk.

To exit the Unit Call mode, cycle radio power or change channel.

## Receiving a Unit Call



When an incoming Unit Call is received, an alert tone will sound and the display will show the incoming P25ID. If the P25 in use matches a programmed ID in the Call List, the label associated with the ID will be displayed. (See Call List Programming)

The telephone icon flashes to indicate an incoming Unit Call. After the reception the icon will continue to flash to indicate a missed Unit Call.

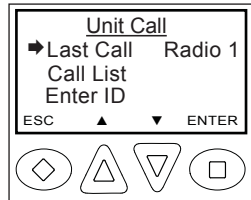

To view the caller ID press the button programmed for 'U2U' or select 'Unit Call' form the programmed menu. The P25 ID number or label will be displayed next to "Last Call".

To clear the phone icon cycle radio power.

## Unit-to Unit Callback

*If enabled, pressing PTT during the hold time results in a Unit-to-Unit call to the received unit ID.*

## Call List Programming

If enabled with the PC radio editor, the P25 Call List can edited via the radio's keypad programming function. (See Keypad Programming)

## Encryption Options

### Tx Secure (TXS)

When SEC is on, encrypted channels programmed for switchable encryption will transmit an encrypted signal.

NOTE: The SEC switch has no effect on channels programmed as Encrypted or Clear Only channels.

Toggle switch operation

- On - Slide the programmed switch toward the front of the radio.
- Off - Slide the switch up toward the channel select switch.

Button Operation

- On - Press the programmed button. **TXS**

Off - Press the button again. **TXS**

### Menu Operation

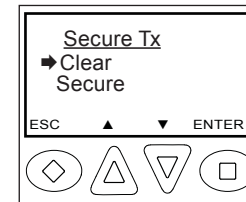
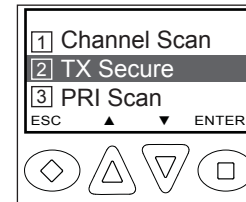

1. Press the assigned Menu button.
2. Use the up/down buttons to select 'TX Secure'.
3. Press the 'ENTER' button.
4. Use the up/down buttons to select Secure or Clear.
5. Press the 'ENTER' button to set the selection.
6. Hold the 'ESC' button to return to normal operation.

## Zeroize Keys (ZER)

The radio provides a method for the user to zeroize all encryption keys. This service also sets all touchpad passwords to 'FFFFFF'. The Zeroize Keys function can be assigned to a button or the radio menu.

To initiate the Zeroize Function:

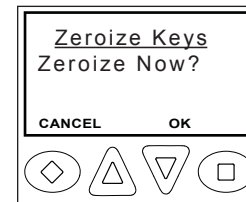

1. Press the button programmed for "ZER" or select 'Zeroize Keys' form the programmed menu.
2. Press the 'OK' button to erase the Encryption Keys, or press 'CANCEL' to cancel the operation.

Wait for the radio to start beeping and for the 'ZERO ALL' message to appear on the LCD.

The radio will stop beeping and the 'ZEROIZED' message will appear on the LCD after all keys are destroyed.

## Pick List Options

The KNG provides users the ability to select and assign Pick List functions to specific channels. Pick List options include: Transmit Code Guards, Transmit NACs, Talk Group IDs and Encryption Keys. Pick List Options can be assigned to a programmed button or a radio menu item.

### Picklist- TX CxCSS (UTON)

Selecting a CTCSS/CDCSS tone from the Pick List will assign the tone to the transmit function of the currently select channel. Receive tones will not be effected. User selected tones can only be set on channels where the transmit mode is programmed as Analog or Mixed Mode.

Operation:

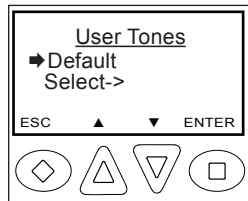

1. Press the button programmed for 'UTON' or select 'User Tones' form the programmed menu.
2. Use the up/down buttons to select 'Default' or 'Select'.

*Default* - Uses the transmit tone programmed to the specified channel.

*Select* - Use the up/down buttons to select the desired tone (1-32) or select the tone using the numeric keypad.

3. Press the 'ENTER' button to set the selection and return.
4. Hold the 'ESC' button to return to normal operation.

NOTE: When entering the pick list screen, 'Select' will be highlighted and the current tone displayed if the channel is currently programmed for a selected tone.

One line of the display may be programmed to show selected picklist items. If a tone other than the default to is selected the programmed line will display T:xx, where 'xx' represents the selected tone.

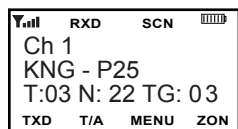
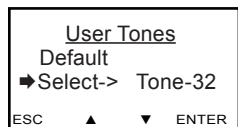

### Picklist – TX NAC (UNAC)

Selecting a Network Access Code from the Pick List will assign the NAC to the transmit function of the currently select channel. Receive NACS will not be affected.

Operation:

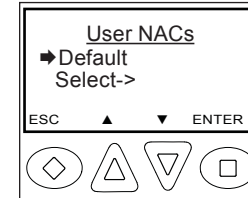

1. Press the button programmed for 'UNAC' or select 'User NACs' form the programmed menu.
2. Use the up/down buttons to select 'Default' or 'Select'.

*Default* - Uses the transmit tone programmed to the specified channel.

*Select* - Use the up/down buttons to select the desired NAC (1-32) or select the tone using the numeric keypad.

3. Press the 'ENTER' button to set the selection and return.
4. Hold the 'ESC' button to return to normal operation.

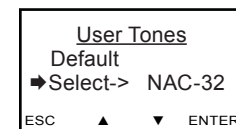
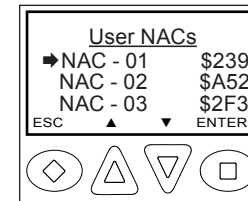

NOTE: When entering the pick list screen, 'Select' will be highlighted and the current NAC displayed if the channel is currently programmed for a selected NAC.

One line of the display may be programmed to show selected picklist items. If a NAC other than the default to is selected the programmed line will display N:xx, where 'xx' represents the selected NAC.

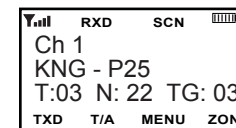



## Picklist – TGID (UTG)

Selecting a Talk Group ID from the Pick List will assign the TGID to the currently select channel. All other channels are unaffected.

Operation:

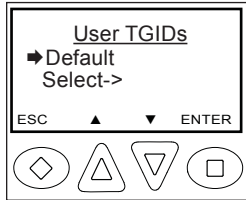

1. Press the button programmed for 'UTG' or select 'User TGIDs' form the programmed menu.

2. Use the up/down buttons to select 'Default' or 'Select'.

*Default* - Uses the TGID programmed to the specified channel.

*Select* - Use the up/down buttons to select the desired TGID (1-32) or select the TGID using the numeric keypad.

3. Press the 'ENTER' button to set the selection and return.

4. Hold the 'ESC' button to return to normal operation.

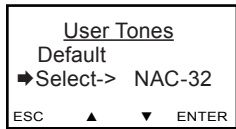
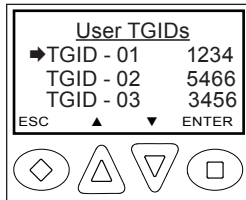

NOTE: When entering the pick list screen, 'Select' will be highlighted and the current TGID displayed if the channel is currently programmed for a selected TGID.

One line of the display may be programmed to show selected picklist items. If a TGID other than the default to is selected the programmed line will display TG:xx, where 'xx' represents the selected TGID.

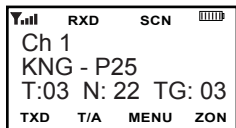

## Picklist – Key (UKEY)

Selecting an Encryption Key from the Pick List will assign the Key to all encrypted channels that do not have 'Key Lock' programmed. Locked key channels will continue to use the pre-programmed key.

Operation:

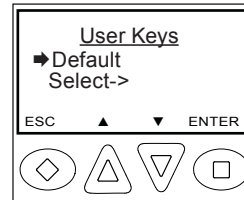

1. Press the button programmed for 'UKEY' or select 'User Keys' form the programmed menu.

2. Use the up/down buttons to select 'Default' or 'Select'.

*Default* - Uses the Key programmed to the specified channel.

*Select* - Use the up/down buttons to select the desired Key (1-32) or select the Key using the numeric keypad.

3. Press the 'ENTER' button to set the selection and return.

4. Hold the 'ESC' button to return to normal operation.

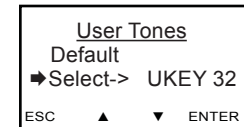
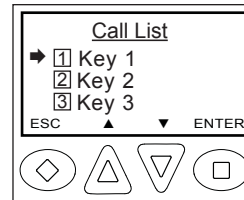

NOTE: When entering the pick list screen, 'Select' will be highlighted and the current selected key displayed if the channel is currently programmed for a selected key.



## Keypad Programming Options

If enabled via PC programming, the radio's Picklists and Individual Call List information can be edited using the keypad. In addition, programmed channel, zone and some global settings can also be programmed. Check with your RELM/BK Radio dealer or communications officer for information on the programmed functions of your radio.

Programmable categories include Individual P25 ID Quick Call/Receive List, User Tone List, User NAC List, User Talk Group ID List and Keypad Programming of Channel, Zone and Global radio parameters.

## Programming P25 ID Unit Call/Receive List

The KNG can be pre-programmed with up to 100 Project 25 IDs and labels. If 'RX'd Unit ID' is designated as a display line, the P25 ID of the radio sending the call will be shown when receiving a digital signal. If the P25 ID of the received call is programmed in the Call List, the alphanumeric label associated with the ID will be displayed. If the P25 ID is not in the Call List, the numeric P25 ID will be displayed.

To enter P25 Call List programming:

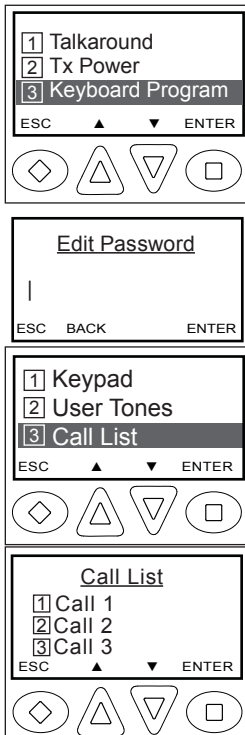

1. Select 'Keypad Programming' from the programmed menu.
2. Enter the User or Administrator Password.
3. Use the up/down buttons to select 'Call List'.
4. Use the up/down buttons to highlight the P25 ID you wish to edit or select the ID using the numeric keypad.
5. Press ENTER to display the alphanumeric label and P25 ID of the selected ID.

## Editing the label

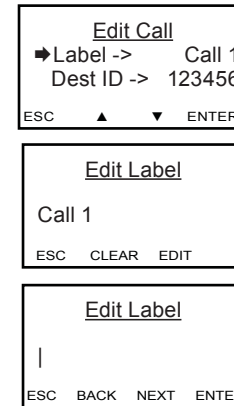

1. Use the down arrow button to highlight the label.
2. Press the ENTER edit the label.
3. Press 'CLEAR' or 'EDIT'. Use the keypad to select the desired character. (See Keypad Character Chart.)
4. Press the PR1 button to move to the next character. Labels can contain up to thirteen characters.
5. Press the ENTER button to save the label or ESC to abort the process.

## Editing the ID Number

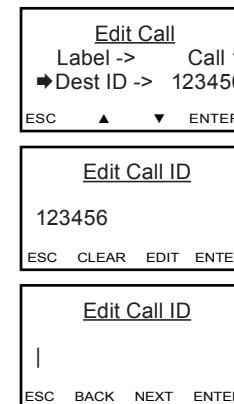

1. Use the down arrow button to highlight the ID.
2. Press the ENTER edit the ID.
3. Use the keypad to select the desired ID number. (Up to seven digits.)
4. Press the ENTER button to save the ID or ESC to abort the process.

## Programming User Selectable Transmit Tones

The KNG can be pre-programmed with up to 32, user selectable, CTCSS or CDCSS subaudible transmit tones. Tones are selected with the programmed buttons. If enabled, the tones can be programmed via the radio's keypad.

To enter P25 Call List programming:

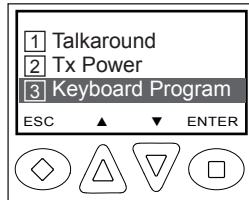

1. Select 'Keypad Programming' from the programmed menu.

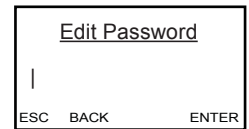

2. Enter the User or Administrator Password.

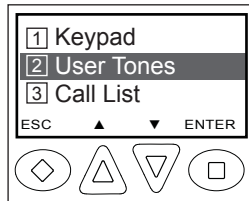

3. Use the up/down buttons to select 'User Tones'.

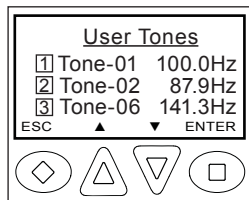

4. Use the up/down buttons to highlight the tone you wish to edit or select the tone directly using the numeric keypad.

5. Press ENTER to display the list of programmed tones. Use the up/down buttons to select the tone for editing.

6. Use the up/down buttons to highlight the User Tone you wish to edit.

## Programming a CTCSS Tone

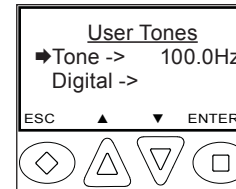

1. Select 'Tone' from the menu.
2. Press the 'CLEAR' button to clear the currently programmed tone or press the or 'EDIT' button to edit the tone.
3. To enter CTCSS tones use the keypad to enter the tone in Hertz. (67.0 - 255 Hz)
4. Press the 'ENTER' button to set the tone and return to the selectable tones list.
5. Hold 'ESC' to return to normal operation.

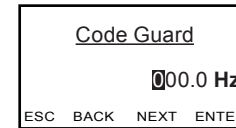
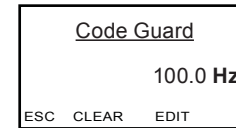

## Programming a CDCSS Tone

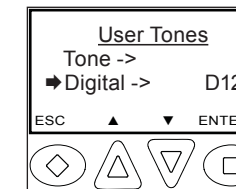

1. Select 'Digits!' from the menu.
2. Press the 'CLEAR' button to clear the currently programmed code guard or press the or 'EDIT' button to edit the guard.
3. To enter CDCSS tones use the keypad to enter a three digit code guard. (000 - 999)
4. Press the 'ENTER' button to set the tone and return to the selectable tones list.
5. Hold 'ESC' to return to normal operation.

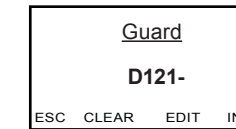
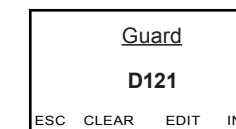

NOTE: If an inverted CDCSS is desired, press the 'INV' button prior to editing the code guard.



## Programming User Selectable Network Access Codes

The KNG can be pre-programmed with up to 32, user selectable NACs. NACS are selected with the programmed buttons. If enabled, the NACs can be programmed via the radio's keypad.

To enter NAC List programming:

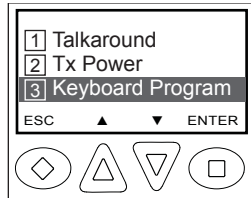

1. Select 'Keypad Programming' from the programmed menu.

2. Enter the User or Administrator Password.

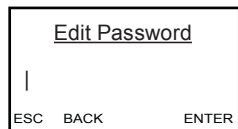

3. Use the up/down buttons to select 'User NACs'.

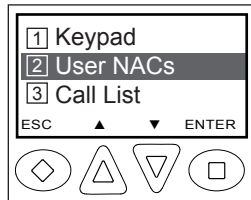

4. Use the up/down buttons to highlight the NAC you wish to edit or select the NAC number directly by using the keypad.

5. Press the 'ENTER' button edit the NAC.

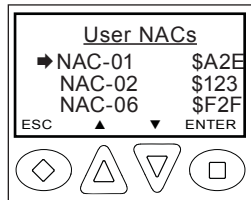

6. Press the 'CLEAR' button to clear the currently programmed NAC or press the or 'EDIT' button to edit the NAC.

7. Use the keypad to select the first digit. Press the 'NXT' button to move to the next character. NACs are programmed as three digit hexadecimal numbers. (000 - FFF)

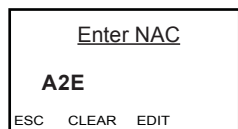

8. Press the 'ENTER' button to set the tone and return to the selectable tones list.

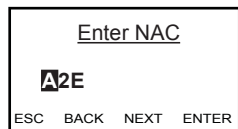

9. Hold 'ESC' to return to normal operation.

## Programming User Selectable Talkgroup IDs

The KNG can be pre-programmed with up to 32, user selectable TGIDs. TDIDs are selected with the programmed buttons. If enabled, the TGIDs can be programmed via the radio's keypad.

To enter TGID List programming:

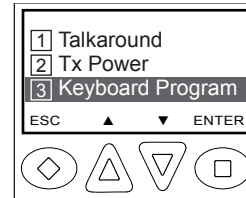

1. Select 'Keypad Programming' from the programmed menu.

2. Enter the User or Administrator Password.

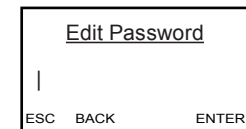

3. Use the up/down buttons to select 'User TGIDs'.

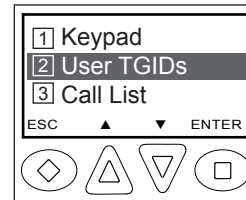

4. Use the up/down buttons to highlight the TGID you wish to edit or select the TGID number directly using the keypad.

5. Press the 'ENTER' button edit the TGID.

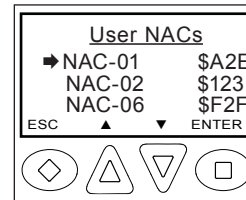

6. Press the 'CLEAR' button to clear the currently programmed TGID or press the or 'EDIT' button to edit the TGID.

7. Use the keypad to program the new TGID. (1 - 65535)

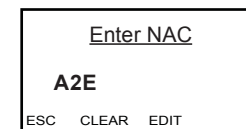

8. Press the 'ENTER' button to set the tone and return to the selectable TGID list.

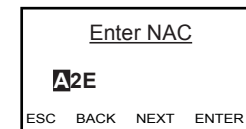

9. Hold 'ESC' to return to normal operation.

## Keypad Programming

If enabled, channel, zone and global parameters can be programmed using the radio's keypad. Individual parameters may be blocked from programming access. Check with your RELM/BK Radio dealer or communications officer for information on the programmed functions of your radio.

### Programming Channel Information

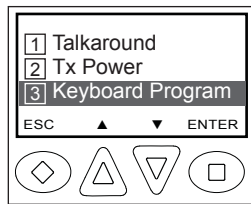

1. Select 'Keypad Programming' from the programmed menu.

2. Enter the User or Administrator Password.

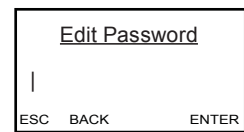

3. Use the up/down buttons to select 'Keypad'.

4. Use the up/down buttons to select 'Channel'.

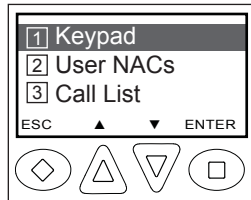

5. Use the up/down buttons to select the zone of the channel you wish to edit or select the zone directly using the keypad.

6. Use the up/down buttons to select the channel you wish to edit or select the channel directly using the keypad.

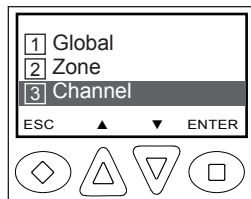

7. Press 'ENTER' to program the channel.

8. Use the up/down arrows to select the function you wish to edit.

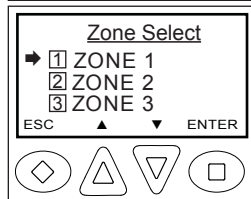

Programmable Channel functions include: Channel Label, Receive Frequency, Receive Mode, Receiver Code Guard, Squelch Mode, Transmit Frequency, Transmit Mode, Bandwidth, Transmit Code Guard, Transmit NAC, Talkgroup ID, Secure Mode selection, Encryption Key Lock and Low Power Lock.

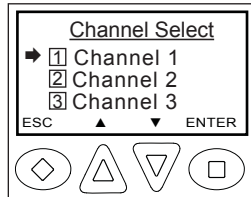

Programmable functions can be selected from the list using the up/down arrows. Alternatively, programmable functions may be selected by using the number buttons to enter the number associated with the desired function.

Programmable Channel Parameter Numbers:

- |                   |                 |
|-------------------|-----------------|
| 1. Channel Label  | 9. Tx Frequency |
| 2. Rx Frequency   | 10. Tx Mode     |
| 3. Rx Mode        | 11. Tx Guard    |
| 4. Rx Guard       | 12. Tx NAC      |
| 5. Rx NAC         | 13. Tx TGID     |
| 6. Squelch Mode   | 14. Key         |
| 7. Bandwidth      | 15. Secure Mode |
| 8. Low Power Lock | 16. Key Lock    |

### Channel Label



1. Select 'Channel Label' from the menu.  
2. Press the 'CLR' or 'EDIT' button to program the label.

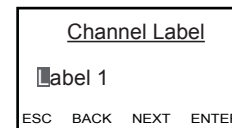

2. Use the keypad to select the desired character. (See Keypad Character Chart.)  
3. Press the 'NXT' button to move to the next character. Labels can contain up to thirteen characters.

4. Press the 'ENTER' button to set the label and return to the programming list.

### Receive Frequency

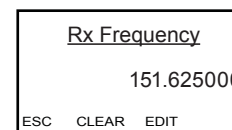

1. Select 'Rx Frequency' from the menu.  
2. Press the 'CLR' or 'EDIT' button to program the frequency.

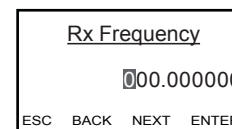

2. Use the keypad to select the desired frequency. (136 - 174 MHz)  
3. Press the 'ENTER' button to set the frequency and return to the programming list.

## Receive Mode

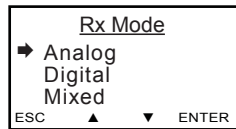

1. Select 'Rx Mode' from the menu.
2. Use the up/down buttons to select the desired receive mode.
3. Press the 'ENTER' button to save the setting and return to the programming list.

## Receive Code Guard

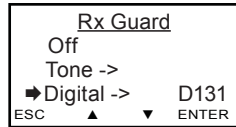
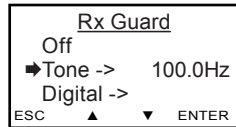
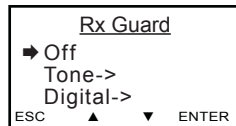

NOTE: Code Guards are available only on channels programmed for analog or mixed mode operation.

1. Select 'Rx Guard' from the menu. The arrow indicates the currently programmed Code Guard for analog signals.
2. Use the up/down buttons to select the desired Code Guard type. (Off = carrier squelch)
3. Use the keypad to program the desired Code Guard. (See below)

## Programming a CTCSS Tone

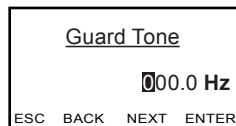

1. Select 'Tone' from the menu.
2. Press the 'CLEAR' button to clear the currently programmed tone or press the or 'EDIT' button to edit the tone.
3. To enter CTCSS tones use the keypad to enter the tone in Hertz. (67.0 - 255 Hz)
4. Press the 'ENTER' button to set the tone and return to the programming menu.

## Programming a CDCSS Tone

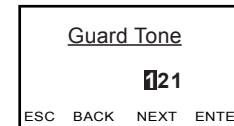
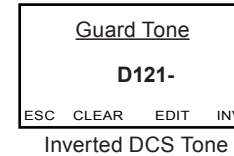
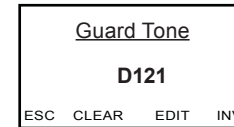

1. Select 'Digital' from the menu.
2. Press the 'CLEAR' button to clear the currently programmed code guard or press the or 'EDIT' button to edit the guard.
3. To enter CDCSS tones use the keypad to enter a three digit code guard. (000 - 999)
4. Press the 'ENTER' button to set the tone and return to the programmable menu.

NOTE: If an inverted CDCSS is desired, press the 'INV' button prior to editing the code guard.

## Receive Network Access Code

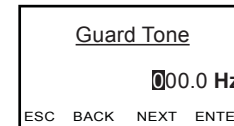
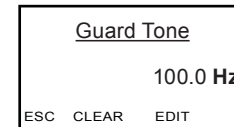

1. Select 'Rx NAC' from the menu.
2. Press the 'CLEAR' button to clear the currently programmed NAC or press the or 'EDIT' button to edit the NAC.
3. Use the keypad to select the first digit.
4. Press the 'NXT' button to move to the next character.

NACs are programmed as three digit hexadecimal numbers. (000 - FFF)

5. Press the 'ENTER' button to set the tone and return to the programming menu.

## Squelch Mode

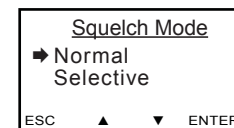

1. Select 'Squelch Mode' from the menu.
2. Use the up/down arrows to select Normal or Selective. (Selective squelch is required for Individual Calls and use of Talkgroup IDs.)
3. Press the 'ENTER' button to set the tone and return to the programming menu.

## Bandwidth

Bandwidth selection is only valid for channels programmed to transmit in analog mode.

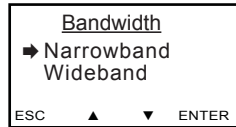

1. Select 'Bandwidth' from the menu.
2. Use the up/down arrows to select Narrowband (12.5 kHz) or Wideband (25 kHz).
3. Press the 'ENTER' button to set the mode and return to the programming menu.

## Low Power Lock

Channels with Low Power Lock enabled ignore the Hi/Lo power switch and operate in Low Power only.

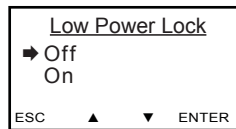

1. Select 'Low Power Lock' from the menu.
2. Use the up/down arrows to select On or Off.
3. Press the 'ENTER' button to set the mode and return to the programming menu.

## Transmit Frequency

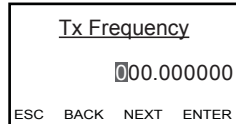
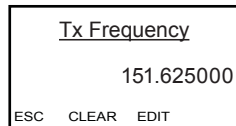

1. Select 'Tx Frequency' from the menu.
2. Press the 'CLR' or 'EDIT' button to program the frequency.
2. Use the keypad to select the desired frequency. (136 - 174 MHz)
3. Press the 'ENTER' button to set the frequency and return to the programming list.

## Transmit Mode

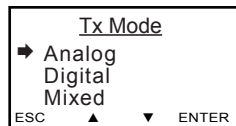

1. Select 'Tx Mode' from the menu.
2. Use the up/down buttons to select the desired receive mode.
3. Press the 'ENTER' button to save the setting and return to the programming list.

## Transmit Code Guard

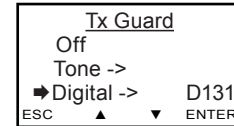
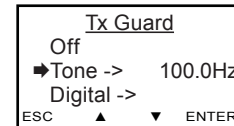
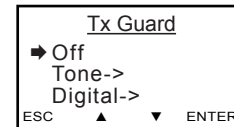

NOTE: Code Guards are available only on channels programmed for analog or mixed mode operation.

1. Select 'Tx Guard' from the menu. The arrow indicates the currently programmed Code Guard for analog signals.
2. Use the up/down buttons to select the desired Code Guard type.  
*Off* = No tone  
*Tone* = CTCSS  
*Digital* = CDCSS  
 Select = Code Guard selected from User Code Guard list.
3. Use the keypad to program the desired Code Guard. (See below)

## Tone - CTCSS Tone

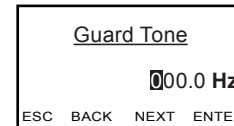

1. Select 'Tone' from the menu.
2. Press the 'CLEAR' button to clear the currently programmed tone or press the or 'EDIT' button to edit the tone.
3. To enter CTCSS tones use the keypad to enter the tone in Hertz. (67.0 - 255 Hz)
4. Press the 'ENTER' button to set the tone and return to the programming menu.

## Digital - CDCSS Tone

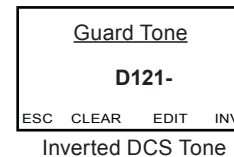

1. Select 'Digital' from the menu.
2. Press the 'CLEAR' button to clear the currently programmed code guard or press the or 'EDIT' button to edit the guard.
3. To enter CDCSS tones use the keypad to enter a three digit code guard. (000 - 999)
4. Press the 'ENTER' button to set the tone and return to the programmable menu.

NOTE: If an inverted CDCSS is desired, press the 'INV' button prior to editing the code guard.



### Select - Picklist Selected Tone

|                |
|----------------|
| Picklist Entry |
| 22             |
| ESC CLEAR EDIT |

1. Select 'Select' from the menu.
2. Press the 'CLEAR' button to clear the currently programmed tone or press the or 'EDIT' button to edit the tone.

|                     |
|---------------------|
| Picklist Entry      |
| 22                  |
| ESC BACK NEXT ENTER |

3. Use the keypad to enter the Picklist Tone number. (1-32)
4. Press the 'ENTER' button to set the tone and return to the programming menu.

### Select - Picklist Selected Tone

|                |
|----------------|
| Picklist Entry |
| 22             |
| ESC CLEAR EDIT |

1. Select 'Select' from the menu.
2. Press the 'CLEAR' button to clear the currently programmed tone or press the or 'EDIT' button to edit the tone.

|                     |
|---------------------|
| Picklist Entry      |
| 22                  |
| ESC BACK NEXT ENTER |

3. Use the keypad to enter the Picklist Tone number. (1-32)
4. Press the 'ENTER' button to set the tone and return to the programming menu.

### Transmit Network Access Code

|                 |
|-----------------|
| Tx NAC          |
| Enter-> \$123   |
| Select-> UNAC32 |
| ESC ▲ ▼ ENTER   |

NOTE: Network Access Codes are available only on channels programmed for digital or mixed mode operation.

1. Select 'Tx NAC' from the menu. The arrow indicates the currently programmed or selected NAC.
2. Use the up/down buttons to select the desired Code Guard type.  
*Enter*=Program TX NAC to channel  
*Select*=NAC selected from User NAC list.
3. Use the keypad to program the desired Setting. (See below)

### Talk Group ID

|                 |
|-----------------|
| Tx TGID         |
| Enter-> 232     |
| Select-> UNTG32 |
| ESC ▲ ▼ ENTER   |

NOTE: Talk groups are available only on channels programmed for digital or mixed mode operation.

1. Select 'Tx TGID' from the menu. The arrow indicates the currently programmed or selected TGID.
2. Use the up/down buttons to select the desired Code Guard type.  
*Enter*=Program TX TGID to channel  
*Select*=TGID selected from User TGID list.
3. Use the keypad to program the desired Setting. (See below)

### Enter - Program NAC

|                |
|----------------|
| Tx NAC         |
| 22E            |
| ESC CLEAR EDIT |

1. Select 'Enter' from the menu.
2. Press the 'CLEAR' button to clear the currently programmed NAC or press the or 'EDIT' button to edit the NAC.
3. Use the keypad to select the first digit.
4. Press the 'NXT' button to move to the next character.

|                     |
|---------------------|
| Tx NAC              |
| 22E                 |
| ESC BACK NEXT ENTER |

NACs are programmed as three digit hexadecimal numbers. (000 - FFF)

5. Press the 'ENTER' button to set the tone and return to the programming menu.

### Enter - Program TGID

|                |
|----------------|
| TGID           |
| 232            |
| ESC CLEAR EDIT |

1. Select 'Enter' from the menu.
2. Press the 'CLEAR' button to clear the currently programmed TGID or press the or 'EDIT' button to edit the TGID.

|                     |
|---------------------|
| TGID                |
| 232                 |
| ESC BACK NEXT ENTER |

3. Use the keypad to enter the first TGID. (1-65535 - FFF)
4. Press the 'ENTER' button to set the tone and return to the programming menu.

NOTE: F7E and F7F are reserved for receive only.

## Select - Picklist Selected Tone



1. Select 'Select' from the menu.
2. Press the 'CLEAR' button to clear the currently programmed tone or press the or 'EDIT' button to edit the tone.
3. Use the keypad to enter the Picklist TGID number. (1-32)
4. Press the 'ENTER' button to set the TGID and return to the programming menu.

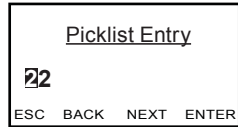

## Encryption Key (Encrypted models)

Encryption keys must be loaded with a compatible key fill device. The radio can hold up to 32 AES and/or DES keys. (See Encryption Operation)

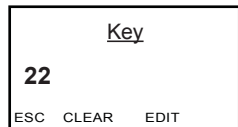

1. Select 'Key' from the menu.
2. Press the 'CLEAR' button to clear the currently programmed key or press the or 'EDIT' button to edit the key.
3. Use the keypad to enter the Picklist key number. (1-32)
4. Press the 'ENTER' button to set the key and return to the programming menu.

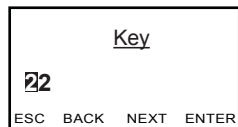

## Encryption Secure Mode (Encrypted models)

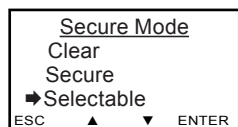

1. Select 'Secure Mode' from the menu.
2. Use the up/down buttons to highlight the desired encryption mode.  
*Clear* = channel always transmits unencrypted.  
*Secure* = channel always transmits encrypted.  
*Selectable* = encryption selected via programmed switch or button
3. Press the 'ENTER' button to set the key and return to the programming menu.

## Encryption Key Lock (Encrypted models)

Encryption Keys can be locked to a channel or selected via a programmed button.

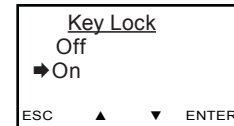

1. Select 'Secure Mode' from the menu.
2. Use the up/down buttons to highlight the desired setting. Off = Selectable Key, On = Locked Key.
3. Press the 'ENTER' button to set the selection.

## Programming Zone Information

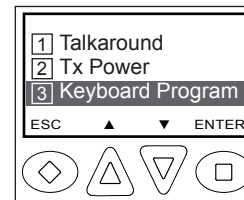

1. Select 'Keypad Programming' from the programmed menu.

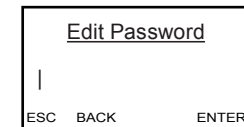

2. Enter the User or Administrator Password.

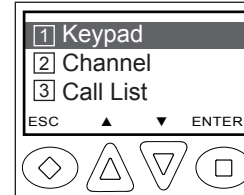

3. Use the up/down buttons to select 'Keypad'.

4. Use the up/down buttons to select 'Zone'.

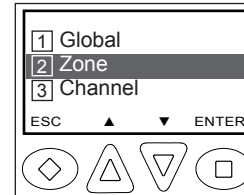

5. Use the up/down buttons to select the zone you wish to edit or select the zone directly using the keypad.

6. Press 'ENTER' to program the zone.

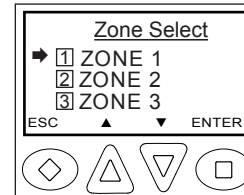

7. Use the up/down arrows to select the function you wish to edit.

Programmable Zone functions include:  
 Zone Label, Priority 1 Channel, Transmit on Priority 1 Channel, Priority 2 Channel, Scan List Lock Automatic-Number- Identification (ANI) Settings and Allow/Disallow Cloning.

Programmable functions can be selected from the list using the up/down arrows. Alternatively, programmable functions may be selected by using the number buttons to enter the number associated with the desired function.

Programmable Zone Parameter Numbers:

1. Zone Label
2. Priority 1 Channel
3. Transmit on Priority 1
4. Priority 2 Channel
5. Scan List Lock
6. ANI/DTMF Mode
7. ANI ID
8. Disable Incoming Clone

### Zone Label

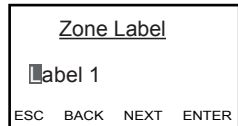
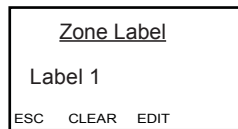

1. Select 'Zone Label' from the menu.
2. Press the 'CLR' or 'EDIT' button to program the label.
2. Use the keypad to select the desired character. (See Keypad Character Chart.)
3. Press the 'NXT' button to move to the next character. Labels can contain up to thirteen characters.
4. Press the 'ENTER' button to set the label and return to the programming list.

### Priority 1 Channel

NOTE: If Global Priority is enabled, Zone priority is disabled.

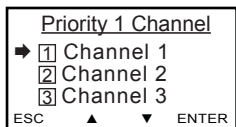
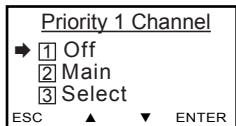

Select a Priority Channel

1. Select 'Priority 1 Channel' from the menu.
2. Use the up/down buttons to highlight the desired Priority Channel.  
*Off* = No Zone Priority Channel.  
*Main* = Priority 1 Channel follows channel select knob.  
*Select* = Assign a Priority 1 Channel.
3. Press the 'ENTER' button to set the selection and return to the programming list.

### Transmit on Priority 1 Channel

If enabled, the radio transmits on the Priority 1 Channel when PRI is turned on.

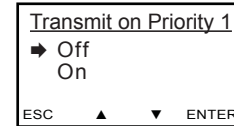

1. Select 'Transmit on Priority 1' from the menu.
2. Use the up/down buttons to highlight the desired setting.
3. Press the 'ENTER' button to set the selection and return to the programming list.

### Priority 2 Channel

NOTE: If Global Priority is enabled, Zone priority is disabled.

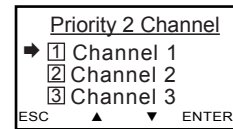
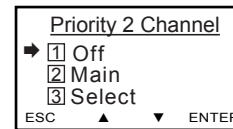

Select a Priority Channel

1. Select 'Priority 2 Channel' from the menu.
2. Use the up/down buttons to highlight the desired Priority Channel.  
*Off* = No Zone Priority Channel.  
*Main* = Priority 2 Channel follows channel select knob.  
*Select* = Assign a Priority 2 Channel.
3. Press the 'ENTER' button to set the selection and return to the programming list.

### Scan List Lock

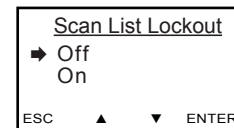

1. Select 'Scan List Lock' from the menu.
2. Use the up/down buttons to highlight the desired setting.
3. Press the 'ENTER' button to set the selection and return to the programming list.

## Automatic Number Identification (ANI/DTMF) Mode

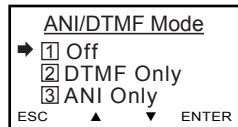

1. Select 'Scan List Lock' from the menu.
2. Use the up/down buttons to highlight the desired setting.

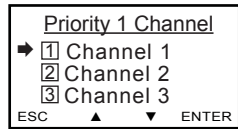

- Off* = No ANI operation.  
*DTMF Only* = Transmit DTMF Tones with keypad.  
*ANI Only* = Send DTMF ANI on PTT.  
*DTMF with Manual ANI* = Keypad Tones and manual ANI.
3. Press the 'ENTER' button to set the selection and return to the programming list.

## Automatic Number Identification (ANI) ID

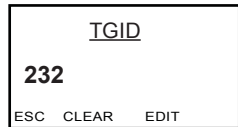

1. Select 'ANI ID' from the menu.
2. Press the 'CLEAR' button to clear the currently programmed ID or press the or 'EDIT' button to edit the ID.



3. Use the keypad to enter the ANI ID. (Up to seven digits)
4. Press the 'ENTER' button to set the ID and return to the programming menu.

## Disable Inbound Cloning

If enabled, the Zone will not accept incoming clone from another radio. If cloning is blocked in any zone, the radio will not accept a full radio clone.

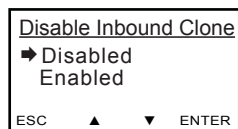

1. Select 'Disable Incoming Clone' from the menu.
2. Use the up/down buttons to highlight the desired setting.
3. Press the 'ENTER' button to set the selection and return to the programming list.

## Programming Global Information

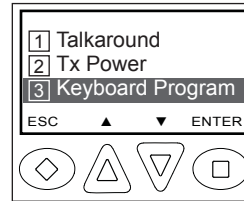

1. Select 'Keypad Programming' from the programmed menu.
2. Enter the User or Administrator Password.
3. Use the up/down buttons to select 'Keypad'.
4. Use the up/down buttons to select 'Global'.
5. Use the up/down arrows to select the function you wish to edit.

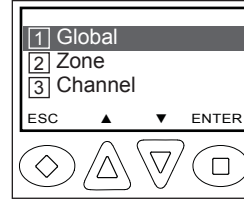
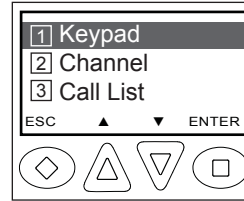
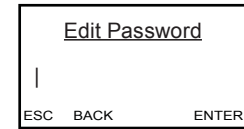

Programmable Global functions include: Priority 1 Channel, Priority 1 Zone, Transmit on Priority 1 Channel, Priority 2 Channel, Priority 2 Zone, Scan Hold Time, Busy Channel Mode, Transmit Time-out-Timer, Backlight Mode, Backlight Duration, Battery Saver, and User Password.

Programmable functions can be selected from the list using the up/down arrows. Alternatively, programmable functions may be selected by using the number buttons to enter the number associated with the desired function.

Programmable Channel Parameter Numbers:

- |                                   |                       |
|-----------------------------------|-----------------------|
| 1. Priority 1 Channel             | 6. Tx Timeout Timer   |
| 2. Transmit on Priority 1 Channel | 7. Backlight Mode     |
| 3. Priority 2 Channel             | 8. Backlight duration |
| 4. Scan Hold Time                 | 9. Battery Saver      |
| 5. Busy Channel Mode              | 10. Edit Password     |

## Global Priority 1 Channel

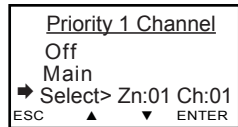

1. Select 'Priority 1 Channel' from the menu.
2. Use the up/down buttons to highlight the desired Priority Channel.

*Off* = No Zone Priority Channel.

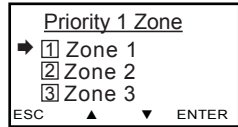

*Main* = Priority 1 Channel follows channel select knob.

*Select*= Use the up/down buttons to select the zone and channel or select the zone or channel directly using the keypad.

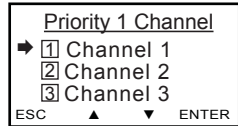

3. Press the 'ENTER' button to set the selection and return to the programming list.

## Tx on Global Priority 1 Channel

If enabled, the radio transmits on the Global Priority 1 Channel when PRI is turned on.

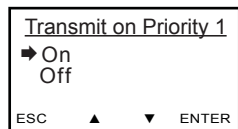

1. Select 'Priority 1 Channel' from the menu.
2. Use the up/down buttons to highlight the desired setting.
3. Press the 'ENTER' button to set the selection and return to the programming list.

## Global Priority 1 Channel

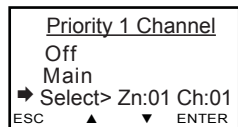

1. Select 'Priority 1 Channel' from the menu.
2. Use the up/down buttons to highlight the desired Priority Channel.

*Off* = No Zone Priority Channel.

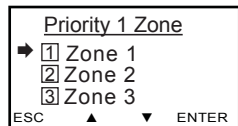

*Main* = Priority 1 Channel follows channel select knob.

*Select*= Use the up/down buttons to select the zone and channel or select the zone or channel directly using the keypad.

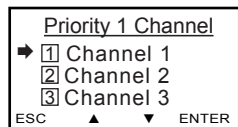

3. Press the 'ENTER' button to set the selection and return to the programming list.

## Scan Hold Time

Scan Hold Time is also used as the Hold Time for programmed talkback functions.

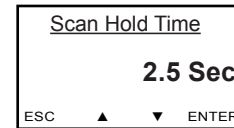

1. Select 'Scan Hold Time' from the menu.
2. Use the up/down buttons to select the desired Hold Time.(0.0 - 7.5)
3. Press the 'ENTER' button to set the selection and return to the programming list.

## Busy Channel Mode

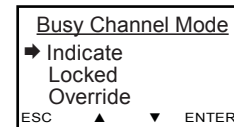

1. Select 'Busy Channel Mode' from the menu.
2. Use the up/down buttons to highlight the desired Busy Channel Operation.

*Off* = No Busy Channel indication.

*Indicate* = Indicator LED glows yellow when the selected frequency is in use.

*Lockout* = Prevents transmitting when selected frequency is in use.

*Override* = Lets the user override the Lockout function and transmit while frequency is busy.

3. Press the 'ENTER' button to set the selection and return to the programming list..

## TX Time Out Timer

The TX Time Out Timer Limits the length of transmissions to the programmed time.

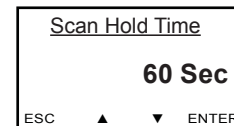

1. Select 'Tx Timeout' from the menu.
2. Use the up/down buttons to select the desired Hold Time.(0 - 225)
3. Press the 'ENTER' button to set the selection and return to the programming list.

## Backlight Mode

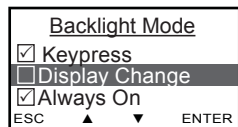

1. Select 'Backlight Mode' from the menu.
2. Use the up/down buttons to highlight the desired Backlight setting.

*Keypress* = Display and keypad light whenever the keypad is used.

*Display Change* = Display and keypad light whenever displayed information changes

*Always On* = Display and keypad light whenever displayed information changes or the keypad is used.

3. Press the 'ENTER' button to set the selection.
4. Press the 'ESC' button to return to the Global Programming menu.

## Backlight Duration

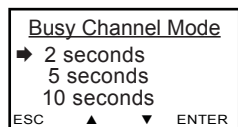

1. Select 'Backlight Duration' from the menu.
2. Use the up/down buttons to select the desired Backlight Time Limit. (2 - 30 seconds)
4. Press the 'ENTER' button to set the selection and return to the programming list.

## Battery Saver

It is recommended that Battery Saver be used for normal radio operation.

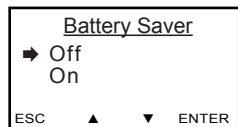

1. Select 'Battery Saver' from the menu.
2. Use the up/down buttons to highlight the desired setting.
3. Press the 'ENTER' button to set the selection and return to the programming list.

## User Password

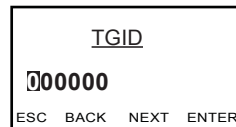
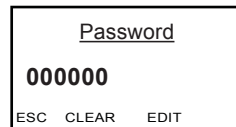

1. Select 'Password' from the menu.
2. Press the 'CLEAR' button to clear the currently programmed Password or press the or 'EDIT' button to edit the Password.
3. Use the keypad to enter a new six digit password.
4. Press the 'ENTER' button to set the password and return to the programming menu.

| Keypad Programming Characters |   |
|-------------------------------|---|
| 1                             | 1   |
| 2 ABC                         | A, B, C, a, b, c, 2                                     |
| 3 DEF                         | D, E, F, d, e, f, 3                                     |
| 4 GHI                         | G, H, I, g, h, i, 4                                     |
| 5 JKL                         | J, K, L, j, k, l, 5                                     |
| 6 MNO                         | M, N, O, m, n, o, 6                                     |
| 7 PQRS                        | P, Q, R, S, p, q, r, s, 7                               |
| 8 TUV                         | T, U, V, t, u, v, 8                                     |
| 9 WXYZ                        | W, X, Y, Z, w, x, y, z, 9                               |
| 0                             | 0, Blank Space  |
| *                             | *, ,, , , ; , : , " , ' , ! , ? , % , & , ' , ~ , @ , _ |
| #                             | #, \$, +, -, =, ^, /, \,  , <, >, {, }, [, ]            |
|                               |   |



## RADIO CLONING

Any "Master" radio (a KNG with the desired radio frequencies and settings) is capable of transferring its program to another KNG of the same frequency range. The radio receiving the program is referred to as the "target" The KAA0710 cloning cable will be required in the following procedure.

### Zone Cloning

When 'Zone' is selected from the cloning menu, information from the selected zone is sent to the corresponding zone of the radio being cloned.

Clone zoned information includes:

|                            |                          |
|----------------------------|--------------------------|
| Channel and Zone Labels    | Scan List                |
| Frequencies                | Bandwidth                |
| Operating Modes            | Low Power Selection      |
| Code Guards (CG)           | ANI Settings             |
| Network Access Codes (NAC) | Zone Priority Settings   |
| Squelch Operation          | Zone Scan List Selection |
| Talk Groups                |                          |

NOTE: Some groups may be blocked by PC programming to prevent them from being overwritten. Only unlocked groups will accept incoming clones.

### Entire Radio Cloning

When 'Entire Radio' is selected from the cloning menu, information from the all zones is sent to the corresponding zones of the radio being cloned.

NOTE: Radios programmed with any zones blocked from receiving cloning information will not accept an 'Entire Radio' clone.

Entire Radio cloning transfers all radio information except the following:

|                           |                 |
|---------------------------|-----------------|
| Radio Serial Number       | Encryption Keys |
| P25 Identification Number | Passwords       |

## Operation

```
Cloning
Zone
Entire Radio
➔ Wait for Incoming
ESC ▲ ▼ ENTER
```

```
Awaiting
Incoming
Clone...
```

Target Radio

```
Cloning
➔ Zone
Entire Radio
Wait for Incoming
ESC ▲ ▼ ENTER
```

```
Zone Select
➔ ① Zone 1
② Zone 2
③ Zone 3
ESC ▲ ▼ ENTER
```

Master Radio

```
Cloning...
```

```
Cloning
Successful
```

```
Cloning Failed
Zone X is
unccloneable
```

1. Make sure the battery packs for both radios are charged.
2. Attach the cloning cable to the side connectors and power up radios.
3. Select 'Cloning' From the programmed menu on both the Master and Target radios.
4. On the Target radio select 'Waiting for Incoming Clone'
5. On the Master radio select the desired cloning function.
  - Select Zone Cloning  
Use the up/down arrows to select the zone to be cloned or select the zone directly using the number buttons.  
Press 'ENTER' to begin cloning.
  - Select Entire Radio Cloning  
Cloning begins when the 'ENTER' button is pressed.

While sending or receiving information 'Cloning...' will be shown on both the Master and Target radio displays. After successful information is transferred 'Cloning Successful' is briefly displayed before reverting to cloning standby mode. Cycle the Target radio power before operating.

If the cloning procedure fails a communications failure will be shown on the Master radio's display. Press 'ESC' to return to the cloning menu.

If the target zone is blocked from accepting a clone, or when *any* zone is blocked during an attempt to do an 'Entire Radio' clone, the 'Cloning Failed' message is displayed.

---

## Warranty

---

The KNG portable radio is covered by a two-year warranty. Extended warranties may be available. For information about your warranty contact RELM/BK Radio at (800) 648-0947. Email; sales@relm.com

---

## Service

---

If you need service, contact your BK Radio dealer. If you find it impractical to have service provided by your dealer, contact the RLM/BK Radio Technical Service Department at (800) 422-6281.

Repairs may be sent to the address below.

RELM Wireless Corporation  
Attention: Customer Service  
7100 Technology Drive  
West Melbourne, FL 32904

---

## Definitions and Acronyms

---

|                        |  |
|------------------------|--|
| AES                    | APCO Project 25 Advanced Encryption Standard   |
| ANI                    | Automatic Numeric Identification   |
| CG                     | Code Guard   |
| CLR                    | Clear  |
| Code Guard             | A sub-audible tone, a code (analog) or a Network Access Code (digital) for selective calling and receiving             |
| DES                    | APCO Project 25 Encryption Standard  |
| Detent                 | The click/hesitation you feel as you turn a knob from one position to another.   |
| DTMF                   | Dual Tone Multiple Frequency   |
| DTMF Tones             | Tones that sound like those used by a standard push-button telephone.  |
| ENTER                  | Enter  |
| Individual Personality | The information programmed with a PC on both a global and by-channel basis that tells the radio exactly how to operate |
| LCD                    | Liquid Crystal Display   |
| Mixed Mode             | Allows Analog & Digital operation on same channel.   |
| NAC                    | Network Access Code for digital channel.   |
| PR                     | Priority Channel   |
| PRI                    | Priority   |
| PTT                    | Push To Talk   |
| RTA                    | Repeater Talk Around   |
| RTX                    | Channel Ready to Transmit Channel  |
| RX                     | Receive  |
| SCN                    | Scan   |
| SQ                     | Squelch  |
| Squelch                | A control that eliminates background noise.  |
| Talkback               | Programmed response to a call.   |
| TGID                   | Talk Group ID  |
| TOT                    | Time-Out Timer   |
| Time-Out Timer         | Limits the duration of calls.  |
| Talk Group ID          | P25 Talk Group Identification  |
| Cloning                | The process of copying data from one radio, called "master," to other radios, called "targets" or "clones."            |

# Your Radio Settings

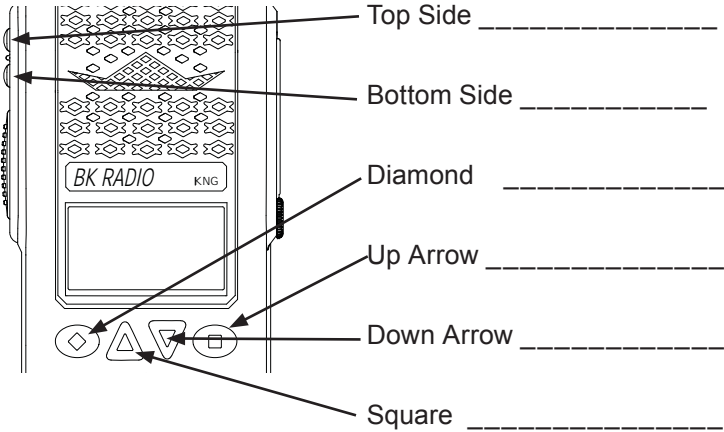
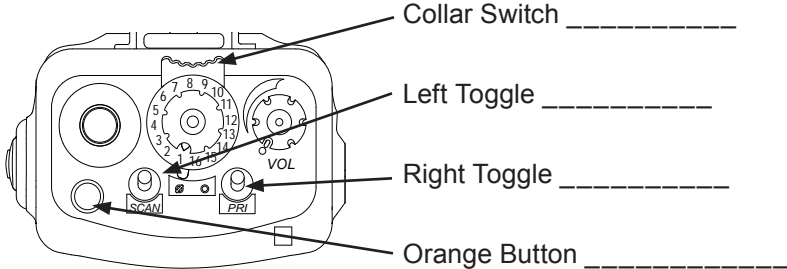

## Menu Settings

|       |       |       |
|-------|-------|-------|
| _____ | _____ | _____ |
| _____ | _____ | _____ |
| _____ | _____ | _____ |
| _____ | _____ | _____ |
| _____ | _____ | _____ |
| _____ | _____ | _____ |