

Welcome to use BLU mobile phone

BLU

Quick Guide

Dash Music

Catalog

Packing list	1
Mobile Phone Appearance	1
Mobile Phone Press Key Function	3
Preparation And Installation	4
Power on and off	10
The main screen	11
On the Main Screen to add Widget.....	12
Replacement of the desktop wallpaper	12
Lock screen	12
Unlock screen	12
The use of touch screen	13
Switching input Method	13
Set Date and Time	14
Through dial -dial.....	15
Answer the call	17
Refuse the call	18
Create and Send MMS.....	19

Camera and video.....	20
Listen to Music	21
MicroSD card as USB large Capacity memory	23
Common Questions and Answers	24
Safety warnings and precautions	25
Non environmental protection material or element name and content description.....	26

Packing list

- ◇ Mobile Phone
- ◇ The USB Connection Line
- ◇ Earphone
- ◇ Charger
- ◇ Battery
- ◇ User's Manual

Mobile Phone Appearance

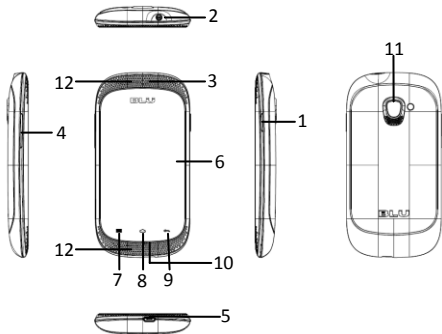

- 1、 Power I
- 5、 USB Int
- 9、 Return

- 3、 Receiver
- 4、 The Volume Keys
- Menu Key
- 8、 The Home Key
- 12、 Loudspeaker

Mobile Phc

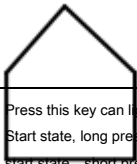

Press this key can light up the screen
 Start state, long press this key can eject the mobile phone
 start state , short press this key can close the screen



Press this key to return to the main screen
 Long press this key can open the list of recently used programs



Long press this key to close the soft keyboard
 Press this key to open the current interface menu



Press this key to return to the interface
 Press this key to exit the program



Press this key to adjust the phone volume

Preparation And Installation

(1) open the cover of battery

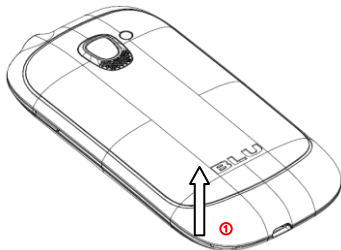

① Along the handle position(groove) of the Battery Cover

(2) Remove the Battery

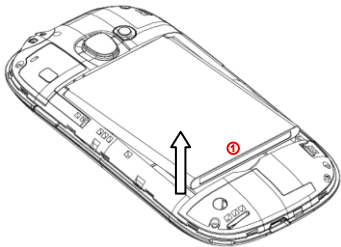

① According to the diagram to remove the battery

(3) Insert SIM/USIM card 1

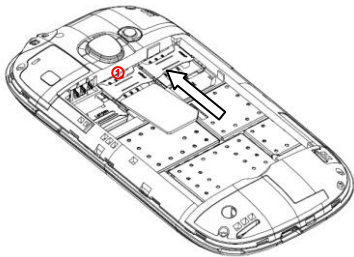

① According to the diagram insert the SIM/USIM card 1

(4) Insert SIM card 2

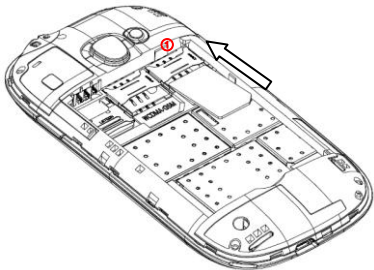

① According to the diagram to insert SIM card 2

(7) Insert microSD card

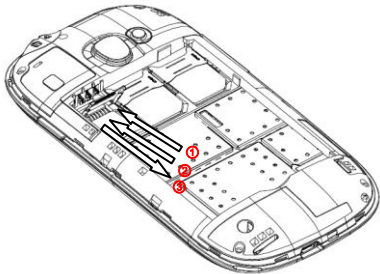

- ① Hold down the microSD sheet , let go , iron spring。 ② microSD card inserted into the card slot ③

Insert microSD card and lock plate as shown in the figure

(9) The back cover covered

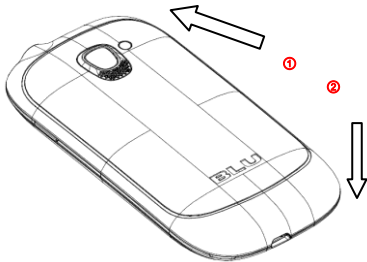

① insert cover as shown in the figure

② cover the cover as show in the figure

Power on and off

Power on

Long press  and will be powered on , if you are the first , You can conduct some Personalization according to your preference on mobile phone.

Power off

- 1、 Long press  , open mobile phone menu
- 2、 Choose shutdown。



The main screen

Ps : Long press the blank area of the main screen, you can add shortcuts. long press the shortcut , you can

drag it to the trash or position you want and you can also drag an icon to the position of a shortcut.

On the Main Screen to add Widget

- 1、 Long press the blank area of the main screen , choose a small plug-in.
- 2、 Choose the widget that will be added to the main screen.

Ps : You can short press  →add →Widgets , Choose the widget that will be added to the main screen.

Replacement of the desktop wallpaper

- 1、 On the main screen you can short press  Wallpaper.
- 2、 Wallpaper way: Wallpapers、 Live wallpapers、 Gallery、 BLU Wallpapers

Lock screen

- 1、 Short press  when the mobile phone opened , and the screen will be locked.
- 2、 When the Mobile phone is idle for a period of time ,and the time of the standby screen is over, the screen will lock automatically.

Unlock screen

- 1、 Short press  , and the screen will be unlocked.
- 2、 According to the instructions on the screen, you can press the unlocking icon to the right slide to Unlock.

The use of touch screen

The use of mobile phone touch screen can more easily select a project or executive function, understand the basic actions to use the touch screen.

PS: 1、 In order to avoid scratching the touch screen, do not use sharp objects.

2、 The touch screen can not contact with other electronic equipment, equipment, electrostatic discharge may lead touch screen to failure.

3、 The touch screen may not contact with water, a touch screen in a humid environment or when in contact with water may malfunction.

Switching input Method

1、 In the interface of text editor (for example: search、 text editor) , Long press the input box , it will pop up the menu of edit text.

2、 Choose the input method

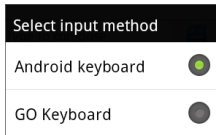

3、 Choose the input method to use

Set Date and Time

1、 Click  → Settings → Date and Time

2、 Set Date



3、 Set Time

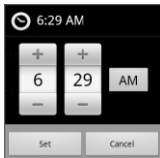

4、 Select date format

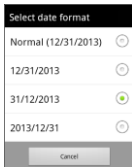

Through dial -dial

1、 Short press  →Call log , enter dialing interface。

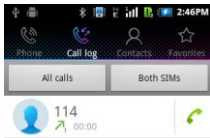

2、 Click the number keys and input the phone number.

3、 Click  , Outing call。

Ps : If your mobile phone to support intelligent dialing function , when you input number keys , your mobile phone will automatically search the contacts and list the matching contact. At the same time ,you can also long press the number→ “Add to contacts”and will enter a number to contacts.

Answer the call

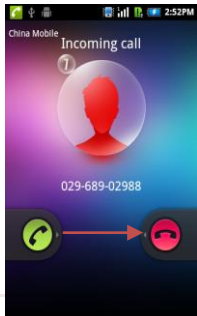



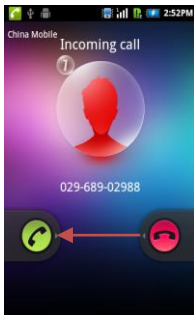

When the call is coming ,drag green answer key  to the right to answer the phone.

Refuse the call



When the call is coming , drag red reject key  the left to reject the phone.

Create and Send MMS

- 1、 Short press  →Messages→compose new message。
- 2、 Click on the recipient , enter the phone number or click  to choose addressee from contacts。
- 3、 Click on the content on the input field and begin to input information content.
- 4、 Short press  , click on “add subject” and input the subject of the MMS.
- 5、 Short press   to send MMS .

Ps : You can also press  and click “attach” to select pictures and others as attachments.

Open data services

- 1、 Press  →Settings。
- 2、 Click “Dual SIM settings”→Data→select the default data card .
- 3、 Click “wireless and networks”→“Mobile networks”→Select “Data enabled” to open the default SIM card data service.

Open the Wi-Fi

- 1、 Press  →settings。
- 2、 Click “Wi-Fi” to open Wi-Fi

Ps : If you have opened the Wi-Fi and the operator of the data provided by the service , the Wi-Fi data service priority , the operator of the data provided by the service in Wi-Fi connection after an interruption.

Connect Wi-Fi

- 1、 After opening Wi-Fi , click →settings。
- 2、 Click “Wireless and networks”→**Wi-Fi Settings**. Mobile phone will automatically list search within Wi-Fi.
- 3、 You can choose to be connected to the network.

Through Wi-Fi hotspot shared data connections.



- 1、 Click → settings 。
- 2、 Click“ Wireless and networks”→ “Tethering and portable hotspot”
- 3、 Selecting portable Wi-Fi box and sharing your data connection

Camera and video

- 1、 Click →Camcorder。





Ps : At set interface , short press :an close camera.

Take photo

- 1、 In the standby screen, open the application list and select camera.
- 2、 Counterclockwise rotation mobile phone into a flat screen mode.
- 3、 Hold polka dot  of slid bar, and drag it to the  .
- 4、 Take camera lens shootings at objects and adjust.
- 5、 Select  and take photo. Photo will automatically save.

Shoot video

- 1、 In the standby screen, open the application list and select Camcorder.

- 2、Counterclockwise rotation mobile phone into a flat screen mode.
- 3、Hold polka dot  of slid bar, and drag it to the .
- 4、Take camera lens shootings at objects and adjust.
- 5、Select  and shoot video。
- 6、Select  and end the video。 The video will automatically save.

Listen to Music

Open Music Player

- 1、Click  → Music to open Music Player.

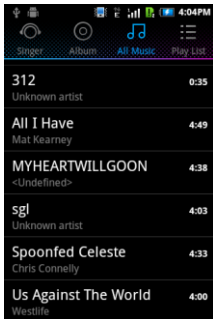

Play Music files

- 1、 In the music player to select a category
- 2、 Click to play music files

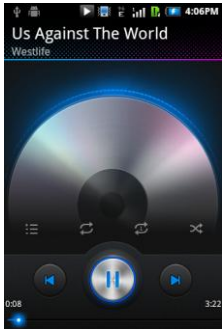

MicroSD card as USB large Capacity memory

- 1、 Using USB line, Mobile phone can connected to the computer and the computer will recognize SD card for removable device.
- 2、 Open notice panel , open the notice that USB is connected

3、 Click the button that opening the USB storage device

Now you can exchange file between the computer and mobile phone microSD card.

Common Questions and Answers

How to import contacts from SIM card ?

Click Menu in the contact interface→“Import/Export”→“Import from SIM card: SIM 1/SIM2”

How to set default mobile data ?

Click  →settings→Dual SIM settings→Data→SIM 1/SIM 2

How to set the unlock pattern ?

Click  →settings →Location and security→ Set up Screen card lock→ Pattern

How to hide a soft keyboard ?

Click  can hide a soft keyboard

How close Proximity screen mode ?

Click  →settings→Display→proximity screen off

How to return the call interface ?

If your mobile phone call in the other interface ,you can click on state tips column, sliding down and open the state panel, click the current call return call interface.

How to stop playing background music ?

Click on the state tips column, sliding down the open state panel, click the music playback information bar.

Safety warnings and precautions

In the use and operation of the equipment , Please read and comply with the following matters needing attention , in order to avoid danger or illegal case , and ensure the optimum device performance.

Security Warning :

- ✧ In some medical devices such as hearing aids or pacemaker ,using mobile phone should be paid attention to : Keeping open mobile phone and the distance between these medical equipment at least 20cm.
- ✧ In oil depots、chemical factories and other explosive production process locations ,in hospitals and other places with special requirements , please pay attention to the restriction of the use of the mobile phone.
- ✧ In sending a call ,please don't pull antenna or contact exposed part , It will affect the communication effect and consuming more energy, Thereby reducing the talk and standby time. At the same time, the danger to the antenna may also cause skin smile burns.
- ✧ Please keep the equipment and accessories drying. Do not use a microwave oven and other external heating equipment of its drying treatment.
- ✧ Please pay attention to traffic safety , Do not use mobile phone while driving , if you need, please park your car.
- ✧ Please send the mobile phone in the children to reach places, in order to avoid the child be treated

as children's toys, resulting in personal injury.

Matters needing attention :

- ◇ When the charging is finished or not charging , please disconnect the connection to the equipment and unplug the power from power supply base.
- ◇ Do not use metal conductor and the two poles of the batter connection ,or contact battery terminals, So as not to cause the short circuit of the battery, and the battery overheating caused by burn and other physical damage.
- ◇ Prohibit the batteries at elevated temperatures or into a fire, so as to avoid the explosion.
- ◇ Battery charging and discharging frequency of up to hundreds of times, but because of the use of a limited life span, when using time(talk and standby time)was significantly shorter when recommend that you replace the battery.
- ◇ Do not attempt to disassemble the battery.
- ◇ When the battery or charger is old and damaged or appearance aging please stop using.
- ◇ If the battery is damaged, should avoid contact with the material inside, if touches the skin , using plenty of water to wash ,if necessary ,please seek medical help.

Non environmental protection material or element name and content description

1. Environmental description



The products according to the national laws and regulations 《electronic information products pollution control management measures》 of the relevant provisions. Using the national industry standard 《SJ/T

11364-2006 of the pollution control of electronic information products》 in the pollution control of electronic information products logo.

2. Produces of environmental protection type of substance or element name and content

Component Name	Non environmental substances and elements					
	Lead (P b)	Mercury (H g)	Cadmium (C d)	Hexavalent Chromium (Cr (VI))	Polybrominat biphenyls (PBB)	Polybrominated diphenylethers (PBDE)
Body Shell	○	○	○	○	○	○
Casing internal alloy parts	X	○	○	○	○	○
Display	X	○	○	○	○	○
Circuit Board (Including Speakers、 a microphone and a vibrator)	X	○	○	○	○	○
charger	○	○	○	○	○	○
Battery	X	○	○	○	○	○
Earphone	X	○	○	○	○	○
Data Line	X	○	○	○	○	○

○: The toxic and harmful substances in the components of all homogeneous materials in the content in the SJ/T11363-2006 standard limits for the following

X: The toxic and harmful substances in at least the components of a homogenous material content beyond the limits specified in SJ/T11363-2006 standard

Note: The product shell component uses the non-toxic environmental materials manufacturing, contain toxic

substances or elements of the component because of the global technology development level limit to achieve the complete replacement of toxic and harmful substances, but the toxic and harmful substances accounted for only this product extremely tiny content, long term use will not cause injuries to the human body. The actual product configuration please to packing lists.

FCC Regulations:

This mobile phone complies with part 15 of the FCC Rules. Operation is subject to the following two conditions: (1) This device may not cause harmful interference, and (2) this device must accept any interference received, including interference that may cause undesired operation.

This mobile phone has been tested and found to comply with the limits for a Class B digital device, pursuant to Part 15 of the FCC Rules. These limits are designed to provide reasonable protection against harmful interference in a residential installation. This equipment generates, uses and can radiated radio frequency energy and, if not installed and used in accordance with the instructions, may cause harmful interference to radio communications. However, there is no guarantee that interference will not occur in a particular installation. If this equipment does cause harmful interference to radio or television reception, which can be determined by turning the equipment off and on, the user is encouraged to try to correct the interference by one or more of the following measures:

- Reorient or relocate the receiving antenna.
- Increase the separation between the equipment and receiver.
- Connect the equipment into an outlet on a circuit different from that to which the receiver is connected.
- Consult the dealer or an experienced radio/TV technician for help.

Caution: Changes or modifications not expressly approved by the party responsible for compliance could void the user's authority to operate the equipment.

RF Exposure Information (SAR)

This phone is designed and manufactured not to exceed the emission limits for exposure to radio frequency (RF) energy set by the Federal Communications Commission of the United States, Industry Canada of Canada.

During SAR testing, this device was set to transmit at its highest certified power level in all tested frequency bands, and placed in positions that simulate RF exposure in usage against the head with no separation, and near the body with the separation of 10 mm. Although the SAR is determined at the highest certified power level, the actual SAR level of the device while operating can be well below the maximum value. This is because the phone is designed to operate at multiple power levels so as to use only the power required to reach the network. In general, the closer you are to a wireless base station antenna, the lower the power output.

The exposure standard for wireless devices employing a unit of measurement is known as the Specific Absorption Rate, or SAR. The SAR limit set by the FCC is 1.6W/kg, and 1.6W/kg by Industry Canada.

This device is complied with SAR for general population /uncontrolled exposure limits in ANSI/IEEE C95.1-1992 and Canada RSS 102, and had been tested in accordance with the measurement methods and procedures specified in OET Bulletin 65 Supplement C, and Canada RSS 102. This device has been tested, and meets the FCC, IC RF exposure guidelines when tested with the device directly contacted to the body.

The FCC has granted an Equipment Authorization for this model phone with all reported SAR levels evaluated as in compliance with the FCC RF exposure guidelines. SAR information on this model phone is on file with the FCC and can be found under the Display Grant section of www.fcc.gov/oet/ea/fccid after searching on FCC ID: YHLBLUDASHMUSIC.

For this device, the highest reported SAR value for usage against the head is 1.24 W/kg, for usage near the body is 1.13 W/kg.

While there may be differences between the SAR levels of various phones and at various positions, they all meet

the government requirements.

SAR compliance for body-worn operation is based on a separation distance of 10 mm between the unit and the human body. Carry this device at least 10 mm away from your body to ensure RF exposure level compliant or lower to the reported level. To support body-worn operation, choose the belt clips or holsters, which do not contain metallic components, to maintain a separation of 10 mm between this device and your body.

RF exposure compliance with any body-worn accessory, which contains metal, was not tested and certified, and use such body-worn accessory should be avoided.