



www.bluebird.co.kr
www.mypidion.com



HM50

USER MANUAL

- Before using, please read and follow the user warnings.
- In the manual the component's shape and color can be different from the actual model.
- The information in the manual can vary depending on the software version and your mobile carrier.



Field Sales



Field Service



DSD/Route Accounting



Asset Management



Meter Reading



Fleet Management

- This user manual is copyright protected.
- This user manual has been created by the bluebird software co. We have done our best not to create typos, editing errors, and leaving out any information. Please understand if there are any inconveniences.
- This product's program is legally protected. Illegal copying, transmitting, or erasing of the program is prohibited
- This product's partial functions might have problems from the environment, user program, and other machines.
- This wireless equipment cannot service related to safety of human lives due to possible signal interference.

REGISTERED



PIDION as the future mobile's leading global brand, expresses with reliability, representativeness, and image of advanced technology. It is a registered trademark from the global brand of Bluebird Soft. and is copyright protected.

NOTICE TOUSERS

MODEL TYPE	NOTICE TO USERS
Class B Device (Household Information and Communication Device)	This device has qualified the electromagnetic wave suitable registration and can be used as a household device at a residential area as well as any other areas.

※ PLEASE READ THE WARNING SIGNS BEFORE USING THIS PRODUCT.

Notice Before Using the Device -----	2	Connecting ActiveSync -----	23	Phone -----	36
Precautions Before Using the Battery -	4	Installing on PC -----	23	Making a Call -----	36
About the Product -----	5	Using ActiveSync -----	25	Receiving a Call -----	37
Checking components -----	5	Connecting ActiveSync -----	28	Blocking a Call -----	37
Getting to know your device's each part -	6	Using the Barcode Reader -----	29	Hanging Up -----	38
Getting to know the buttons -----	7	Using the Barcodes -----	29	Contacts -----	39
Learning Basics -----	10	Scanning with Barcodes -----	29	Searching -----	39
Insert/Remove the battery -----	10	Checking Barcodes -----	30	Adding a Contact -----	39
Insert/Remove the USIM card -----	12	Getting to know your Home Screen --	31	Menu -----	41
Insert/Remove the MicroSD card -----	14	Looking at the Home screen -----	31	Camera -----	42
Connecting the hand-strap -----	17	up photos as Home Screen Background -	31	Taking Photos -----	42
Charging with Cradle -----	19	Adjusting Volume -----	32	Viewing Photos -----	43
Turning On -----	20	Checking Battery Level -----	32	Settings -----	45
Soft Reset -----	20	Inputting Text -----	33	Device Specifications -----	58
Hard Reset -----	21	Selecting text input mode -----	33	Q & A -----	59
Using the Stylus Pen -----	21	Block recognizer -----	33	Service Center -----	60
Adjusting the Display -----	22	Letter recognizer -----	34	Warranty Certificate -----	62
		Transcriber -----	35		

Notice Before Using Device

This information is for your own safety. Please observe the following precautions

- This device is qualified of electromagnetic wave human safety standards. For your own safety please use the authenticated devices only from the head company. If not the case, we cannot guarantee your safety.
- Do not press the power button or the power adapter/cord when the device is wet. There is a danger of electrical shock.
- Do not remodel, take apart, or repair the device. Please refer to your customer service center. If not the case, you will not be able to get your free repair service.
- Please follow instructions when using the batter.
- Do not use your device at an explosive danger zone.
- In case your device is wet, do not put your device in heaters, microwaves, or etc to dry- there is a risk of explosion or it can be the cause of malfunction. (Please note there is a label in the device that changes color when it gets wet. In this case you will not be able to get your free repair service.)
- Do not use your device on-board an airplane or in hospitals.
- Please backup your device's inner data and information. During the repair or upgrade, there is a slight possibility of your data being erased. (Ring tones, text/voice message, characters will be reset.)

- Please refrain from using your device while driving. If you are in an unavoidable situation, stop your vehicle or use your hand free kit.
- Do not use in places of high temperature and high humidity. The following can be the causes of malfunction: getting wet from the rain, spilling drinks, and taking it in with you at the sauna (high temp.) In these cases, you cannot receive your free repair service.
- Do not place credit cards, phone cards, bankbook, and tickets next to the device. The device's magnetism can damage the listed item's information.
- Please avoid impacts or vibrations. When not using the device unplug the power cord and place it at a safe place where it will not drop.
- Do not place your device at a dusty place. Keep your power cord away from any heating devices. Unplug the power cord when cleaning. If there are any dusts or residue clean the power cords pins thoroughly.
- When not using a battery for long periods, please charge it and leave in at room temperature. Even a charged battery's voltage will decrease over time.
- Do not paint your device. It can damage your screen or your device's exterior. Also, the paint can peel off and trigger allergies. If there is a allergic reaction please seek medical advice.

Precautions Before Using Battery

These are safety precautions in order to prevent a dangerous accident. Please use the battery correctly and carefully observe the instructions.

- If the battery is taken apart by impact, applied heat, submersion, or hole-drilling, there is a risk of a dangerous explosion. Please keep away from children and animals.
- Leaving the battery in a hot car or enclosed space where there is direct sunlight, can deform or break down the battery.
- Please take precaution in not letting necklaces, coins and etc touch the battery's terminal (metal part). Do not give an impact on the battery by a sharp object or an animal. There is a risk of explosion.
- Please use only the designated battery for the device. If the original battery is not used, the device's life may decrease and there is a risk of explosion.
(In this case you cannot receive the free repair service)
- When charging the battery you must use the supplied standard power adapter. If the original adapter is not used the battery life may decrease and may explode.
(In this case you cannot receive the free repair service)

1. Checking components

The images in this User's Manual may not reflect the color and shape of the actual product.

(Please contact the Customer Care Center if you wish to purchase any additional or optional products.)



[Main set]

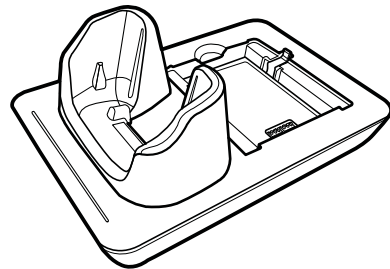

[Desktop Cradle]

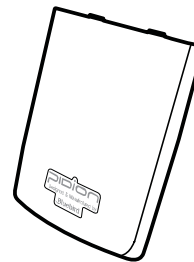

[Battery]

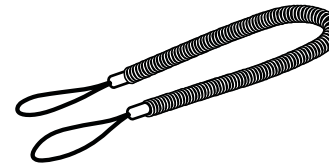

[SpringWire]



[Stylus Pen]

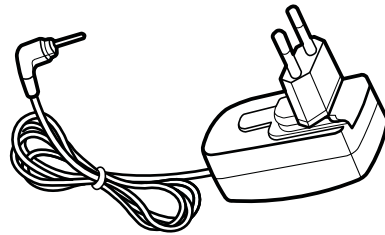

[Adaptor]

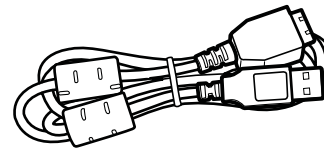

[USB cable]

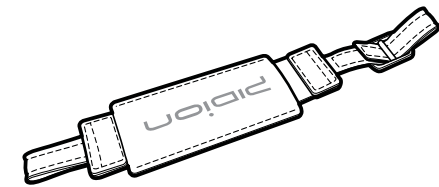





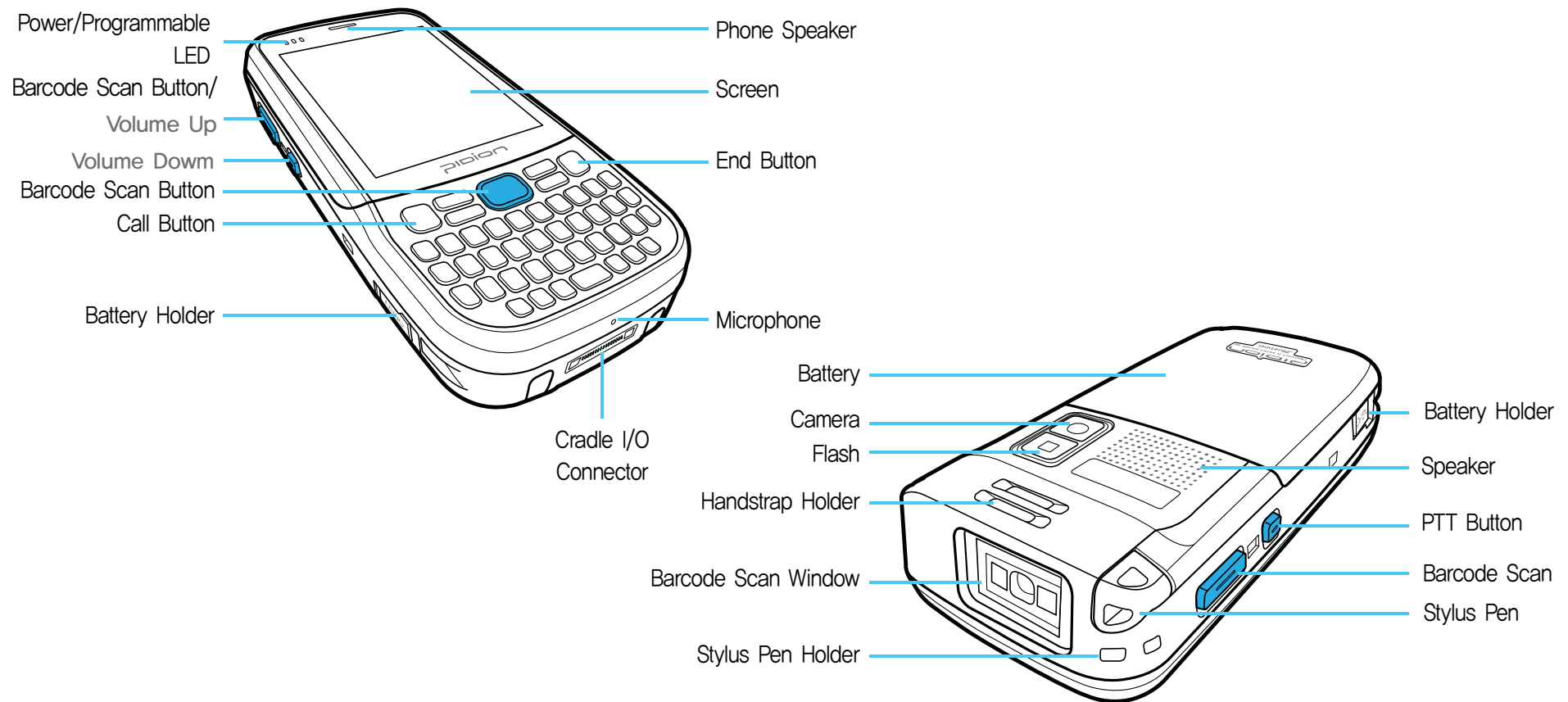

[Handstrap]



Getting to know your Device

2. Getting to know your device's each



About the Product

Button	Description	Button	Description
	<p>SHIFT Button Used to switch between Lowercase/Uppercase English alphabet. (The default is Lowercase English.) If you press this button once and then an alphabet key, the uppercase of the key is entered. Then, input mode is switched to the lowercase. If you press this key twice, the input mode is remained in the Uppercase like Caps Lock until you release it. To release the Caps Lock, you need to press the SHIFT key twice.</p>		<p>Power Button Turns on the device</p>
	<p>Enter Button You can change the row you are typing in. It functions the same as the computer enter button.</p>		<p>Tab Button</p>
			<p>SPACE Button SPACE Button (moves one space forward)</p>
			<p>OK Button</p>

Button	Description
	<p>Flash Button Press this button to set the Function key. If you press and hold this button for over 2 seconds, the LCD display light is switched On/Off. The Display On or Off status is maintained until you press the button again</p>
	<p>Fn Button This button's function is used as a combination. It is used when the blue printed button is used.</p>

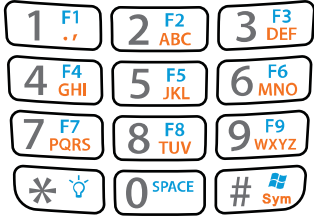
버튼	설명
	<p>Fn Button – NUMERIC This button's function is used as a combination. It is used when the blue printed button is used.</p>
	<p>Numeric / Alphabet / symbol button The default is Numeric. Used to enter numbers, alphabets or symbol.</p>

Learning Basics

1. Insert/Remove the battery

1-1. Insert the battery

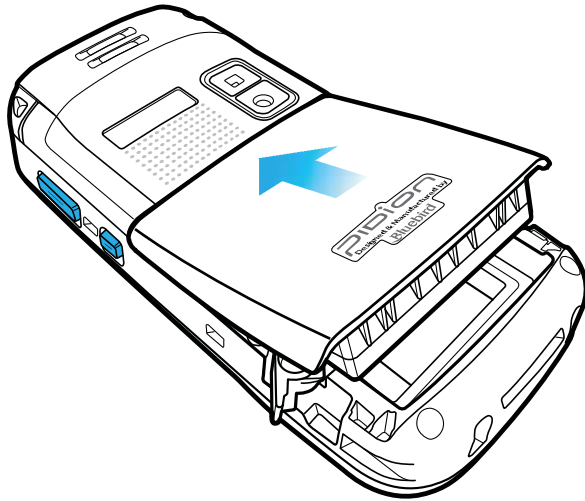

① Push your battery in the direction of the arrow.

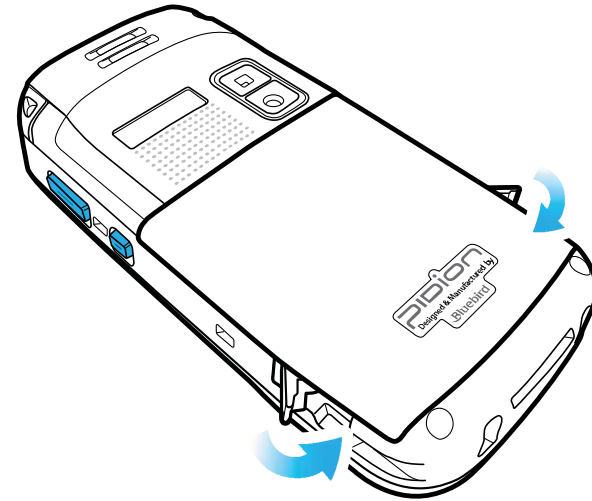

② Turn the battery pins inside to fix the battery.



Only use the supplied adapter to charge your battery.

1-2. Removing the battery

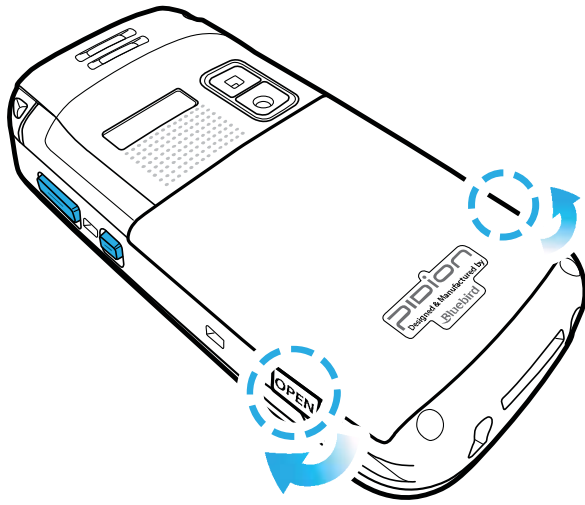

- ① Switch off PDA.
Turn the battery pins outside to remove the battery.

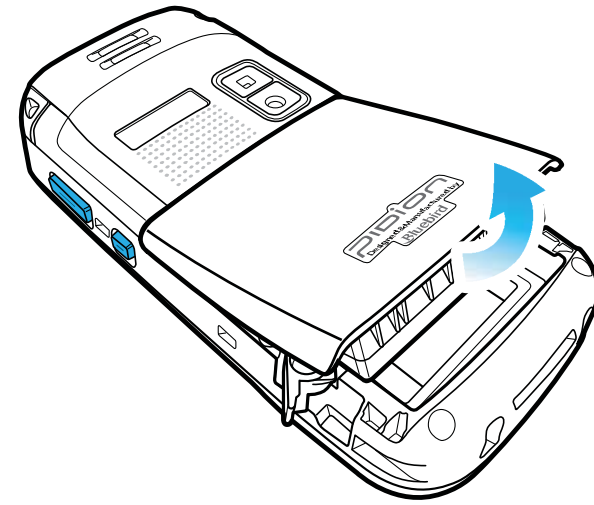

- ② Lift off the battery to the arrow direction.

Learning Basics

2. Insert/Remove the USIM card

2-1. Insert the USIM- I card

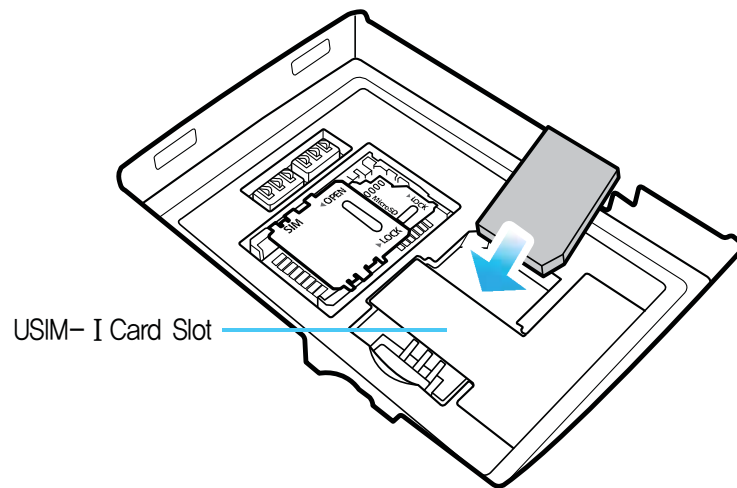

① Slide in the USIM- I card in the arrow direction.

The device supports 2 USIM slots.

2-2. Removing the USIM- I card

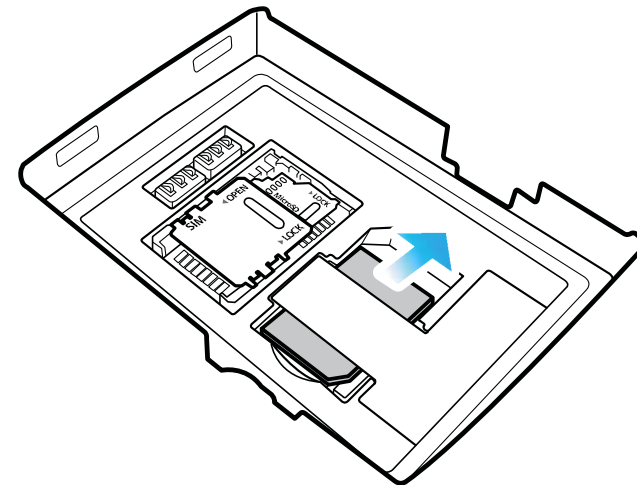

② Push the top of the USIM card to slide it out in the arrow direction.

2-3. Insert the USIM- II card

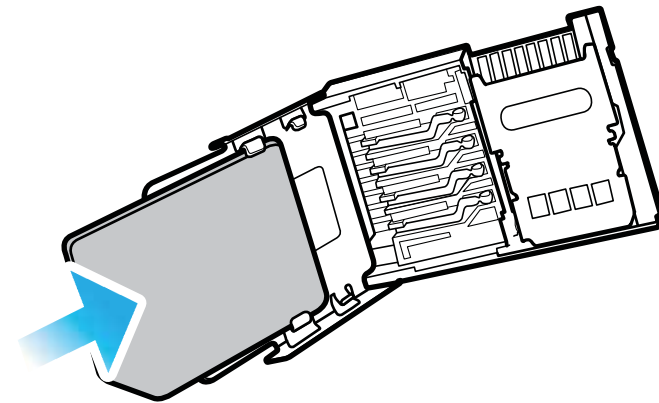
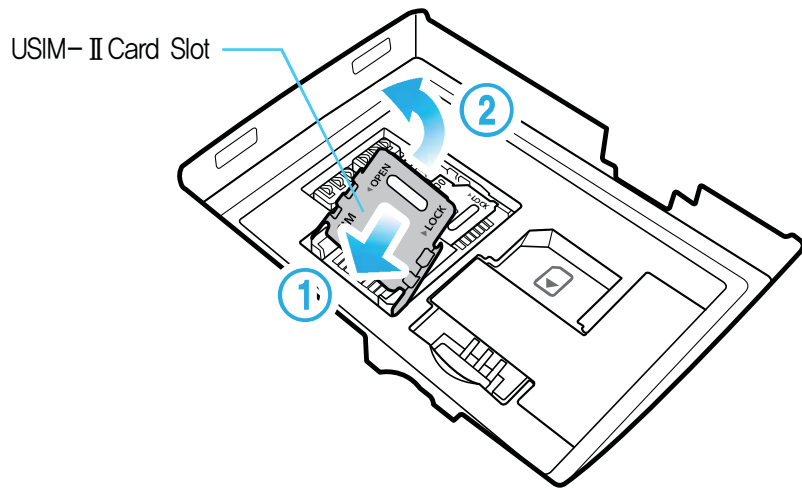

① Push the USIM-II card holder to 'OPEN' direction then lift up.

② Place the USIM-II card on the holder then push down the holder.

Learning Basics

2-3. Removing the USIM- II card

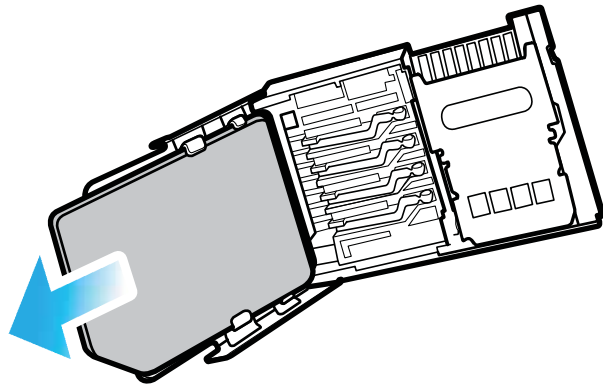

Push the top of the USIM-II card and slide it out from the holder.

3. Insert/Remove the MicroSD Card

3-1. Insert the MicroSD Card

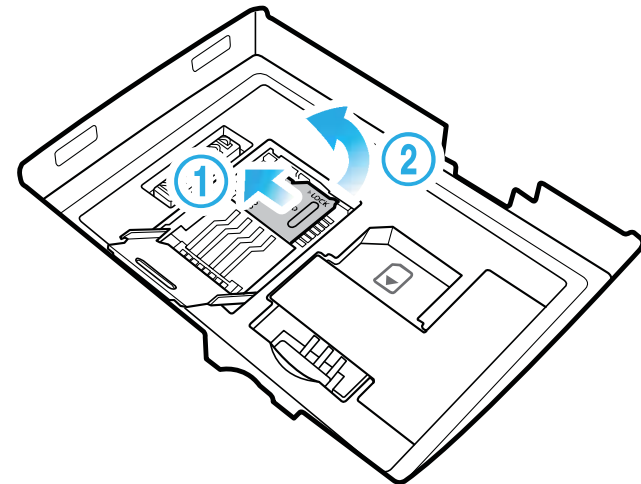

① Open the storage card holder by lifting up the flap.

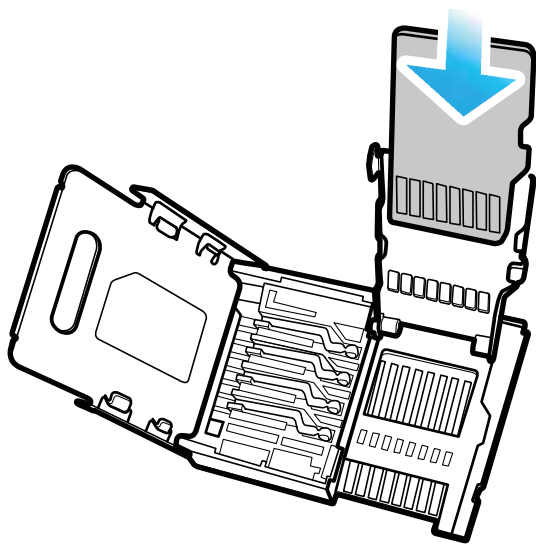

② Insert the microSD card into the storage card holder with its gold contacts facing out.

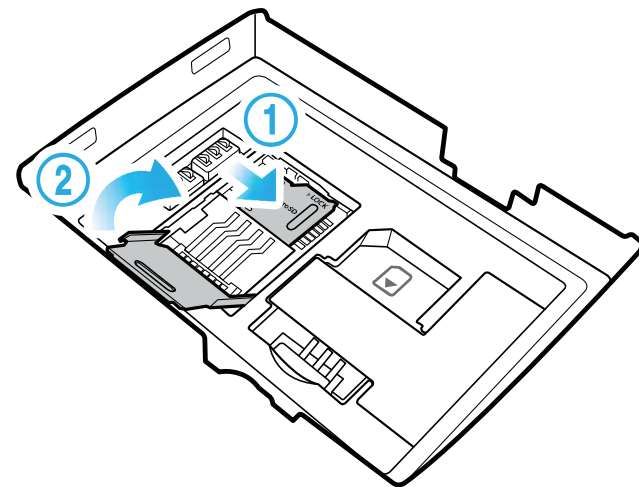

③ Lock the storage card holder by pushing it down into place.

Learning Basics

3-2. Removing the MicroSD card

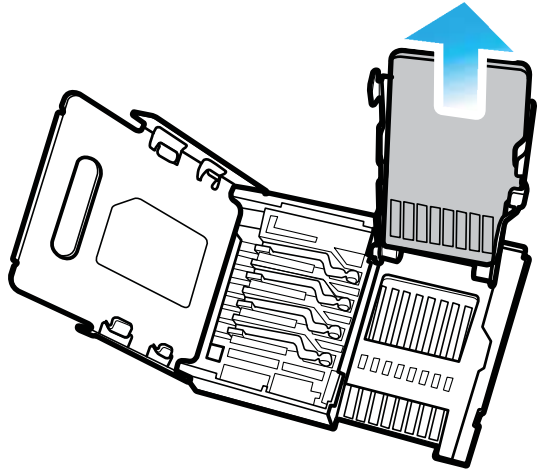

With the USIM card and storage card compartment opened, lift the storage card holder flap to open it.

3-3. Precautions using the MicroSD Card

- The SD card can break if you frequently slide in/out or put or excessively put too much force.
- If the card is removed while being used or being turned off, the data can be lost or malfunction.
- Please back up important data. We are not responsible for the lost data.
- If the memory card does not slide out, do not remove by force. After removing the card at the repair center, exchange your device or get a refund.

4. Connecting the hand-strap

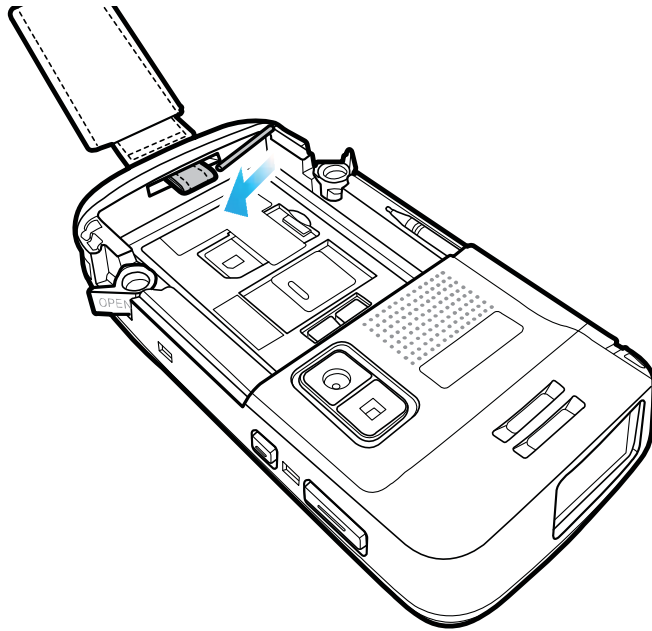

- ① Body in the groove at the bottom of the hand strap hand strap is a push in the direction of the arrow.

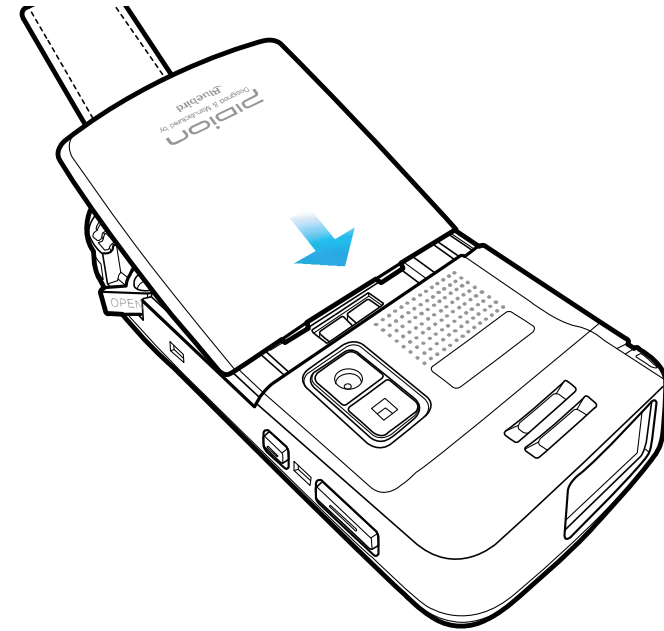

- ② Push your battery in the direction of the arrow.

Learning Basics

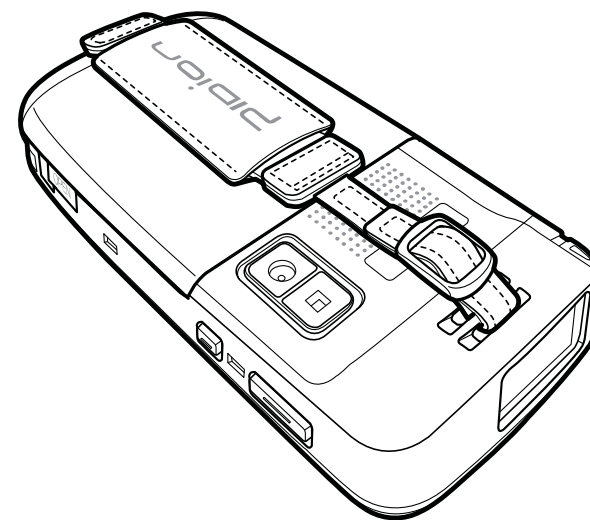
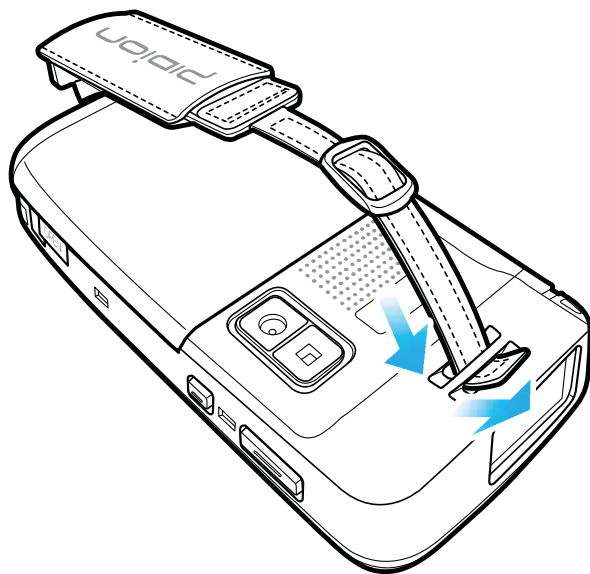

③ Connect the hand-strap holder.

5. Charging with Cradle

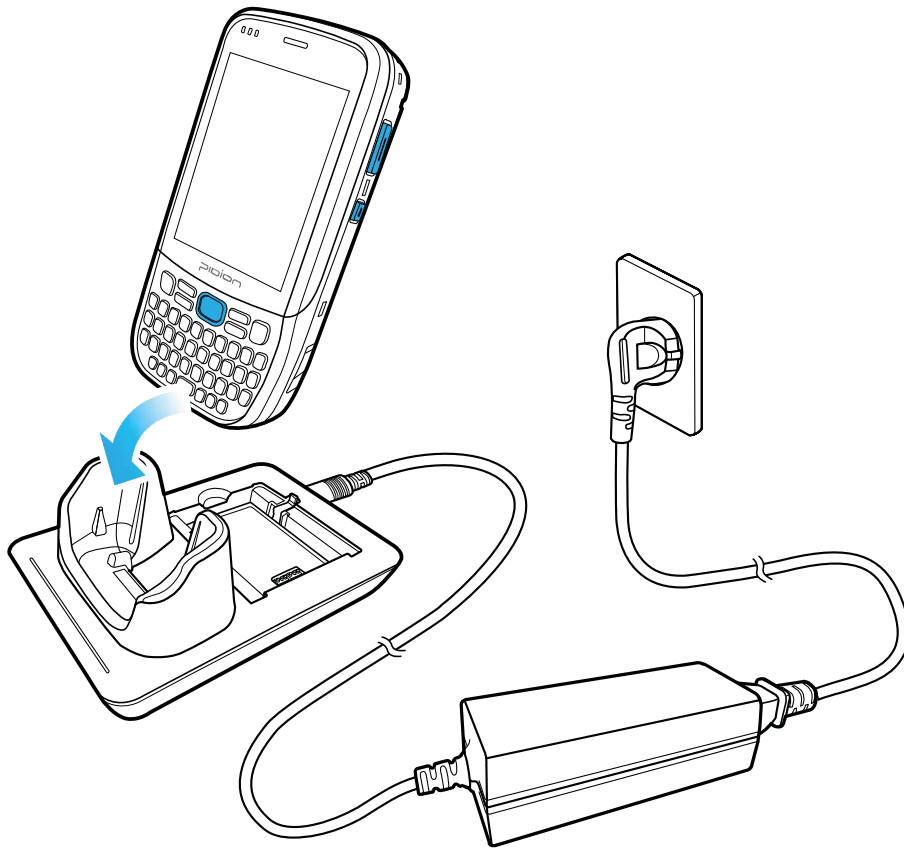

As you see in the picture, connect the adapter with the power cable to charge the PDA.

Power Charging Light

Charging	Orange
Charged	Green



- When the device's battery is low, it may warn you with a ring and a message.
- The charging time can vary depending on the environment. A new battery is only partially charged. Please charge fully before using.

Learning Basics

6. Turning On



- The **[Power]** button is on the front.
- To turn your device on you must press the button shortly.
- After purchasing your device or hard resetting, the booting process can take some time. We apologize for the inconvenience.

7. Soft Reset



To reset, press the **[Power]** button + **[M]**



- Please soft reset if your device freezes or has an unexpected error.
- It is very similar to rebooting your computer. Any information not saved will not be lost.

Learning Basics

10. Adjusting the Display

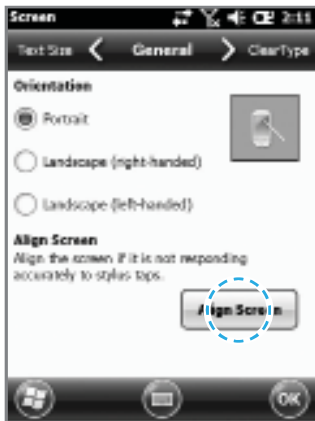

On your LCD screen, it is the function of setting the input value of the stylus pen.

Adjusting screen Setting
Start ▶ Settings ▶ System ▶ display ▶ Screen adjustment



Press the center target accurately followed by left top → left bottom → right bottom → right top.

Connecting ActiveSync

- ② On the window about the license terms, press <I accept the license terms> ► On the [Client information] window, input <User name> ► Specify where you want to install.

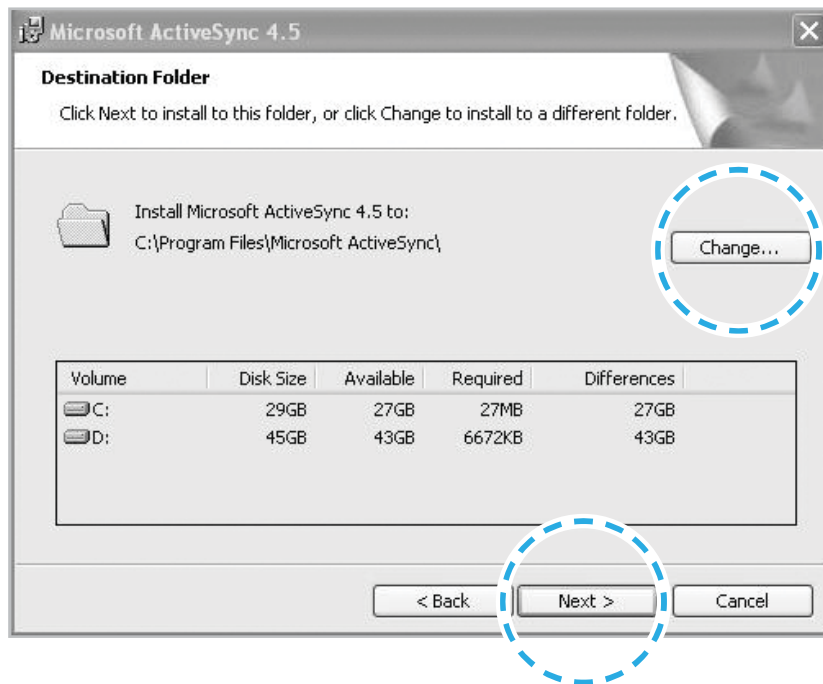

- ③ [Microsoft Active Sync] can be installed when it is ready to install.

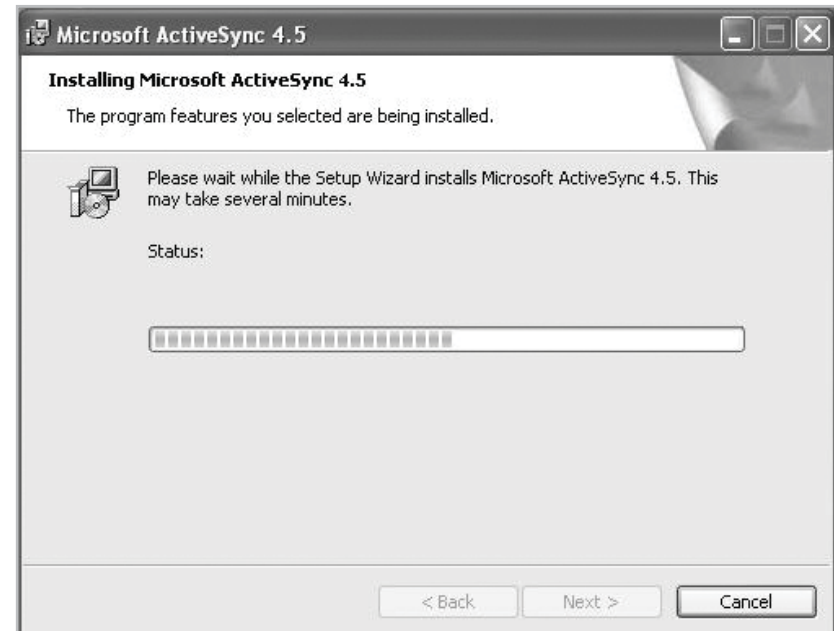

- ④ [Microsoft ActiveSync] is installed.

2. Using ActiveSync

- You can see a Windows Mobile version on the display and it can be different according to the version.
- [**Microsoft ActiveSync**] can be used when the device is plugged into a notebook or pc. You can transfer files by syncing it. You can also install/uninstall new programs.
- The USB cable is sold separately. Please contact the service center for more details. [Code : 12132]

- ① You can connect with the Cradle.

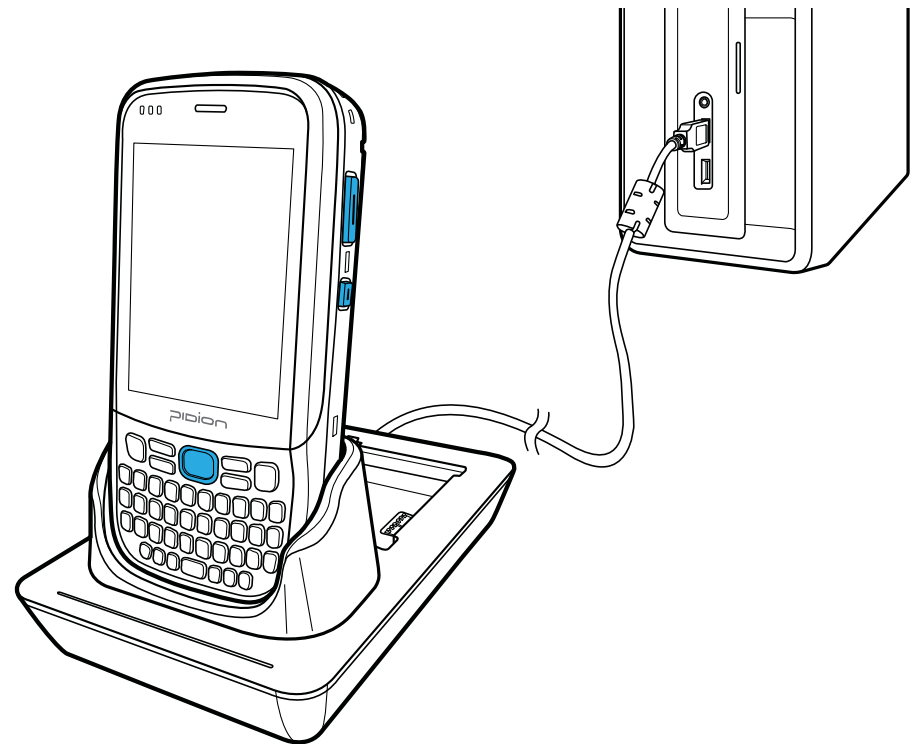

Connecting ActiveSync

② If the device and computer are successfully connected, Microsoft ActiveSync will automatically start. Please select the <Search> button.

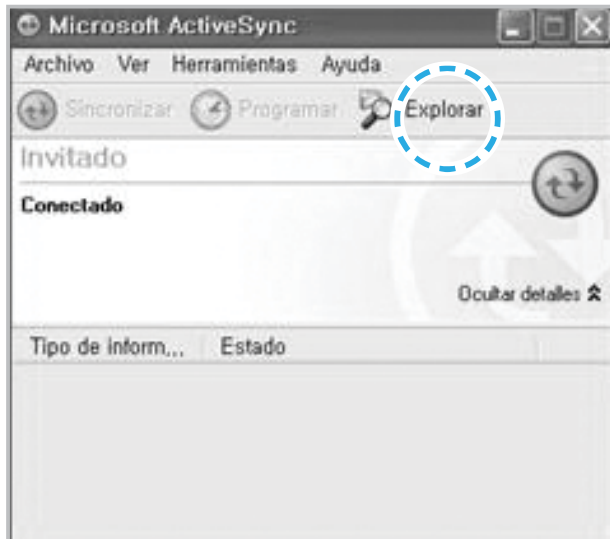

③ In the <Mobile device> folder, you can check the photos, music, and documents stored in the device and move it to the computer.

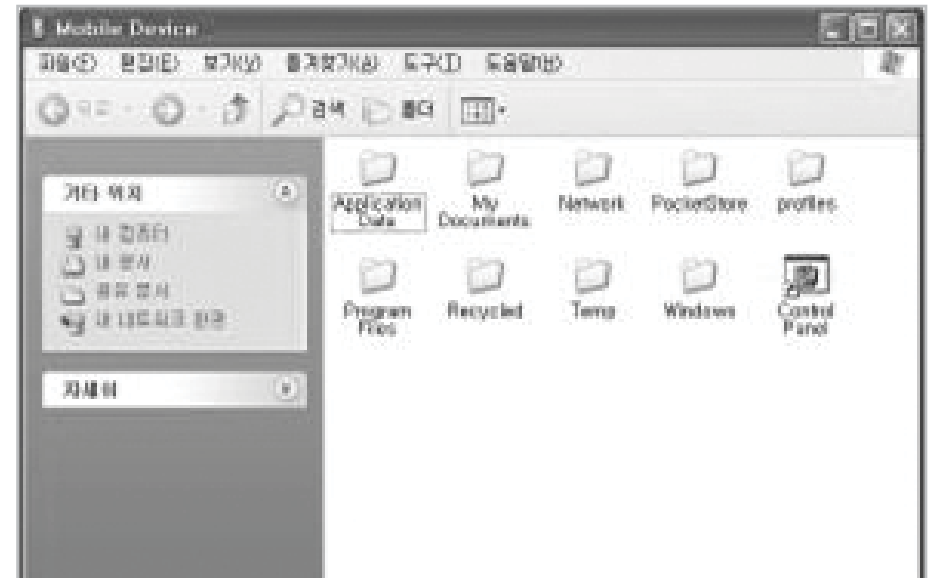

[Precautions using ActiveSync]

- When "unknown USB device" can pop up**, when the device is turning on while connected to the <Micro USB Cable>. If you reconnect the device from the <Micro USB Cable> the ActiveSync will run properly.
- If in ActiveSync, the state "connecting..." is** continued for a long period of time, disconnect the device from the <Micro USB Cable>. In [ActiveSync] press FILE ► CONNECTION SETTINGS ► Select <Allow USB connection> ► Press [OK]. Reconnect the device.
- If you have reconnected several times and still "unknown USB device" pops up**
In certain cases the computer's USB host has gone wrong leading to connection failure.
Remove the device from the <Micro USB Cable> and reboot the computer. Reconnect the device to the cable and it will run properly.

- The device not running after removing the battery while device on.**

For this to be avoided, do not remove the battery while the device is on. You must press the [Power] button or the [Shut Down] button with the stylus pen in order for the Windows Mobile to [turn off] correctly.

If in a case where you have removed the battery while the device is on, hold the [Reset] button + [OK] button to hard reset.

Please note if you hard reset, all the data in the memory will be erased.

Connecting ActiveSync

3. Connecting ActiveSync



Start ► Setting ► Connect ►
USB-PC connect

If you select [**Advanced Network Function Use**] you can connect various Surrounding USB devices to your PDA device.



Your device and the surrounding devices can you used when connected with the <USB Cable>.



If you use the function [**USB-PC Connect**] your device's battery consumption will be high. If you are not using the function [**USB-PC Connect**] disconnect to save your battery consumption.

Using The Barcode Reader

HM50

1. Using the Barcodes

Press the [Barcode Scan] button on the side or front of the device to start scanning barcodes.

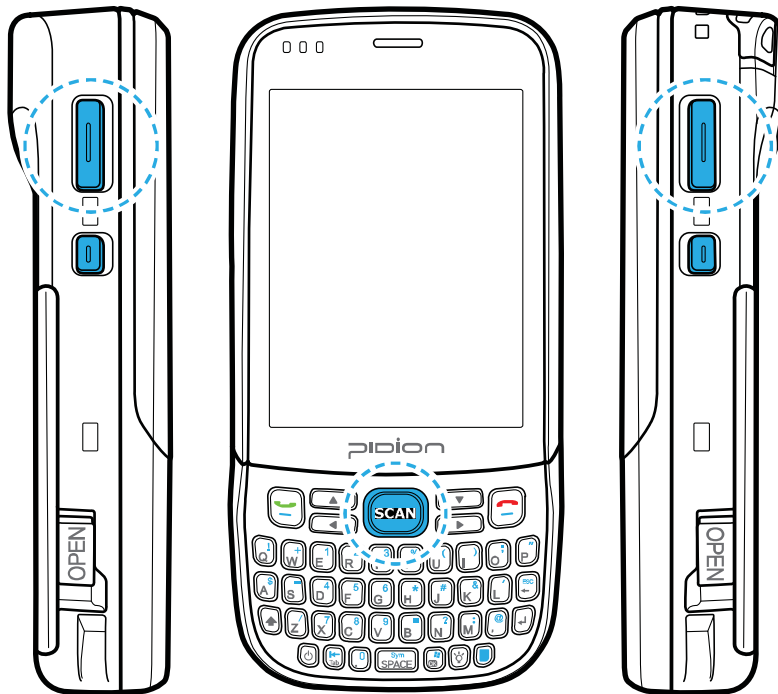

2. Scanning Barcodes

In order to scan accurately, you must scan with the correct angle 10cm away.



If you are using Barcodes with special programs, please contact the manufacturing company.

Using The Barcode Reader

3. Checking Barcodes



Start ► Memo

The barcode's information will appear if you press the **[Create New]** button in **<Memo>**.

If you scan a barcode while **<Memo>** is open, the barcode will be automatically saved in **<Memo>**.

If you scan when **<Memo>** is not opened, it will not be saved. To do this, press the **[Menu]** button in **[Create New]** and **[Paste]** to save.

Getting To Know Your Home Screen

3. Adjusting Volume

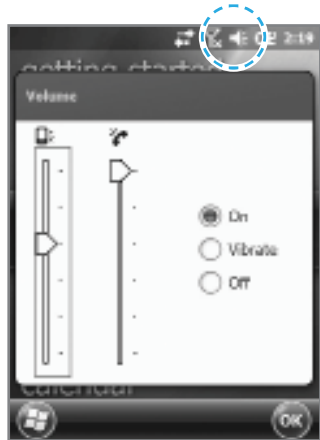

You can adjust your volume for program folders, selecting menus, or In-call volume.

After selecting the  on the top right, you can adjust your system/ ring tone volume.

Selecting Vibrate will make your phone muted and into the Vibrate Mode.

4. Checking Battery Level



You can check your battery level by pressing the  on the top right of your display.

Inputting Text

3. Keyboard

This input method displays an on-screen keyboard that can be used to input characters by tapping the screen using the stylus pen.



4. Letter recognizer

This option allows you to enter text using your own handwriting.

The screen is divided into three different areas. A capital letter area, small letter area, and a number area.

Characters are entered by printing letters in each area. The character is then analyzed and typed on the screen automatically.

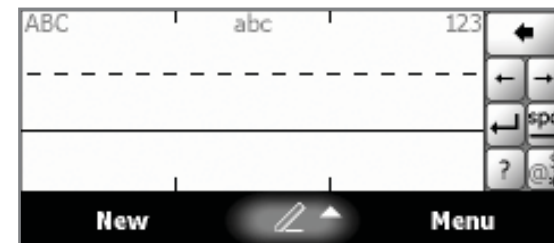

Phone

1. Making a Call

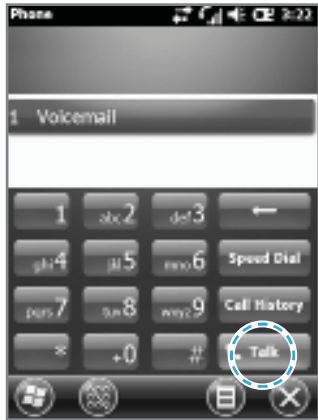



To make a call, press the **[Phone]** button in the bottom of the screen. Input a phone number and press **[Call]**.

Redial

Without inputting the a phone number again, press the **[Call]** button to redial.

 : Deletes mistake numbers.

 : You can use the saved speed dials to make a call. To add/edit/delete a speed dial, press the menu on the bottom right.
(You can save a maximum of 98 speed dials.)

 : You can the recent view received calls/out going calls/missed calls.

 : After inputting a phone number press this button to make the call.

2. Receiving a Call



When you are receiving a call, press the **[Call]** button or the **[Answer]** button on the bottom of the screen.

※ The outgoing information message can be different from the regular devices.

3. Blocking a call



To block a call, press the **[Ignore]** button on the bottom of the screen or the **[End]** button on the keyboard.

You can also block the call by shorting pressing the volume button.

4. Hanging up

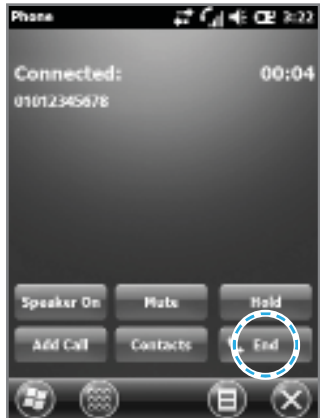

To hang up, press the **[End]** button or the **[End]** button on the device's keyboard.



- The BIP-1500 Does not support conference calls, call transferring optional call services.
- The BIP-1500 Does not support Voice Call during Dial-up.
- The BIP-1500 supports only the regular optional call service <Call waiting>. (The SMS service from call waiting is not supported.)

Contacts



You can use various menus when you hold down the contact.

Call Work/Home/Cell phone : Each numbers saved can be called.

Send Email : Sends email to the saved email account.

Send Message : Sends a text message to the saved phone number.

Copy Contact : Copies the selected contact.

Delete : Deletes the selected contact.



- If the BIP-1500 device has been reset, there will not be a information message when retrieving/deleting a contact list.
- The BIP-1500 device may take some time showing the saved contacts when it has been reset or has been erased from the USIM card.

Camera

1. Taking Photos

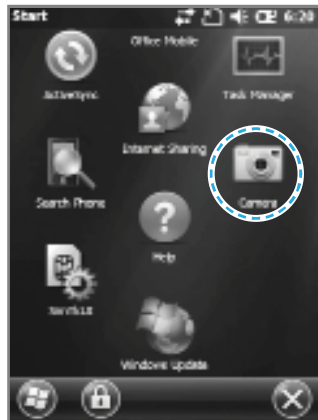

Start ► Camera



Your photo will be taken when you press the [OK] button. The photo/video will be automatically saved in the album.



Video : Switches to Video mode.

Mode : You can set it up as normal/burst/timer.

Resolution : You can set various resolutions of 480x640 / 600x800 / 768x1024 / 1536x2048.

Flash : You can turn on/off your flash.

Full-Screen : You can change your display to full screen.

Option : You can change the name/storing location/file size.



You can do the following options : Delete / Send / Wireless-transfer / Set up as background / Enlarge / Edit / Properties with the photo / Video.



- If the battery is too low, the camera will turn off or will not open.
- If not in use more than a minute, it will go into sleep mode.
- If the device can shoot video, the user manual will vary depending on the camera program.

2. Viewing Photos

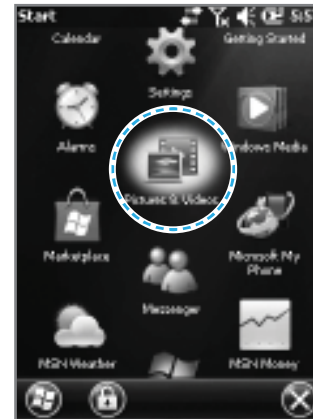

Start ► Photos and Video

You can Enlarge/Reduce or check the information of the saved Photo/Video.



Camera

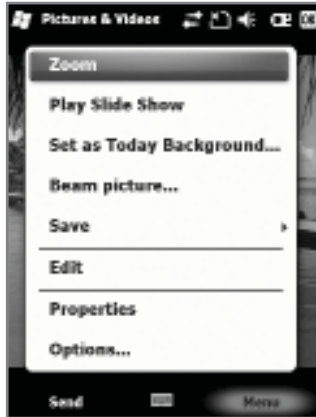

The selected Photo/Video can be Enlarged / Reduced / Viewed with as a slideshow/set as a background / Wireless-transfer / Save / Edit /Properties.

Settings

- ③ Type in the password to connect with the selected device and press **[Next]**. (The password will be different for every device. Please refer to manual)
- ④ Check if you are connecting to the right device. If correct, press **[Finish]**.
- ⑤ If the model name and icon of the device you have chose appears, you are finished connecting.



The pairing method is different for every Bluetooth devices. Please read the manual for other Bluetooth devices.



Lock

Password

Set up a password for your device every time you turn it on.



Start ▶ **Settings** ▶ **Lock**

You must input your password twice.

After selecting **[Press ok if the device is not used for the following time]** set up a time.

The password must be 4~6 characters long. Simple passwords such as [1111] or [1234] cannot be used.

Settings



Sound and Notifications

Sound

You can set up your event, program, screen pressing, hardware button notification sounds.



Start ► Settings ► Sound and Notifications.

If you check each item the (sound and notification) will be setup with a sound.

Notifications

You can set the Notifications sounds when the (sound and notification) is set up.

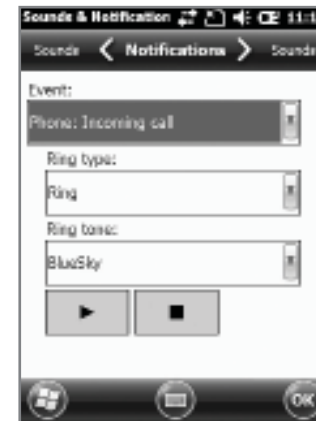

Start ► Settings ► Sound and Notifications ► Notifications

You can set the phone, wireless network, notification, Activesync, and etc sounds by Ring/Vibration.



Home

Background Display

You can set up your photos as the home screen background.



Start ► Settings ► Home

- ① After selecting **[Use this as background]** press the **[Find]** button.
- ② Select the folder that has the photo you want to use in **[Folder]**.
- ③ Select your photo.
- ④ After selecting you photo press **[OK]**.

Items

You can set up items to be displayed on your home screen.

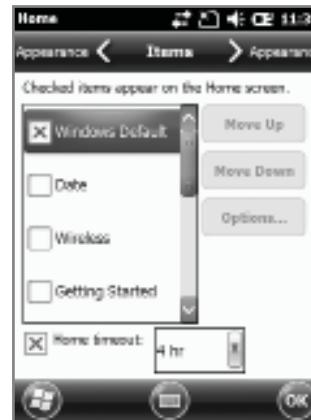

Start ► Settings ► Home ► Items

When you check the item it will be shown on your home screen. You can set the order of the items that are going to be shown by using the **[Move up]** / **[Move down]** button.

Settings



User Information

You can set up a memo or your personal information.



Start ▶ Settings ▶ Personal ▶ User Information

You can set your name, company name, address, phone number, email address, and memo to be shown when your device turns on.



Phone

Phone

You can adjust/turn off the devices sounds.



Start ▶ Settings ▶ Personal ▶ Phone

Ring/Vibration : You can set as Ring / Ring(getting louder) / Ring only once / vibrate / Ring and vibrate / Ring after Vibrate / None.

Ring tones : You can adjust the Ring tones.

Keypad : The key pad sound can be adjusted to Long tone / Short tone / Off when keypad is selected.



Display Light

Battery power / Exterior power

To save battery, you can set the battery power and exterior power to be turned off automatically.

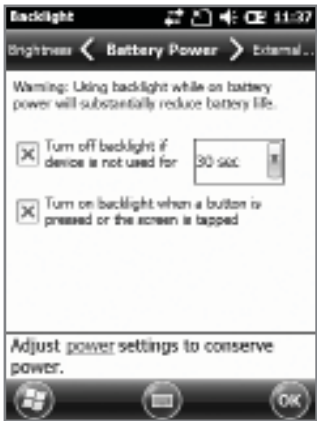

Start ▶ Settings ▶ System ▶ Display Light

The shorter you adjust your display time, the longer your battery will last.

You can turn the light back on again by press the buttons of the display.

Brightness

Use the slider bar to adjust the brightness.



Start ▶ Settings ▶ System ▶ Display Light ▶ Brightness

If you set the brightness of PDA close to **[Darker]** mode, the battery of PDA will last longer.

Settings



External GPS

Program

Select the port you want to use by receiving data from the program's external GPS.

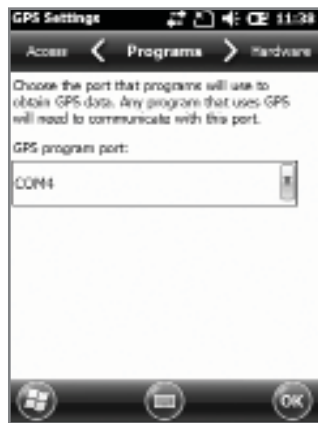

Start ► Settings ► System ► External GPS

All the programs using GPS can communicate with this port.

Hardware

You can designate the hardware port in which GPS devices will connect to.

Access

If you select **[Automatic GPS management]** you can receive multiple program's GPS data simultaneously.



G-Sensor

You can set up the usage for the G-Sensor.

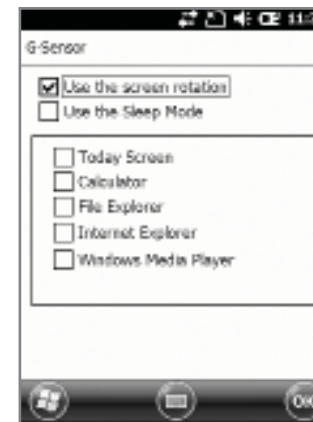

Start ► Settings ► System ► G-Sensor



Memory

The memory's current state (Usage, Available space) will be displayed.



Start ► Settings ► System ► Memory

Main memory

You can check the memory for Total/Usage/Available space of storage and programs.

Storage Card

You can check the usage/available space of the Micro SD memory card and the program store.



Uninstalling Programs

The programs installed by the user or in default will be displayed.



Start ► Settings ► System ► Uninstall Program

Select the program you want to uninstall on the list. Press **[Uninstall]** and it will automatically be removed.

Settings



Display

General

You can change the screen vertically, horizontally (right hand), horizontally (left hand)



Start ▶ Settings ▶ System ▶ Display

You can readjust the stylus pen points by pressing the **[Display Adjust]** button.

Text Size

You can adjust your text in 5 sizes.



Program Monitor

The memory status of running programs will be displayed

Application	Mem	CPU
ActiveSync	624K	0 %
Text Messages	612K	0 %
Contacts	572K	0 %
Pictures & Videos	480K	0 %
Task Manager	92.0K	0 %

Start ▶ Settings ▶ System ▶ Program Monitor

Using the menu you can select the running programs and to stop it. You can also stop all the programs running at once.

Settings

SUMMIT

Setting up Wireless Internet



- ① Select the **[Admin Login]** button on the top right.

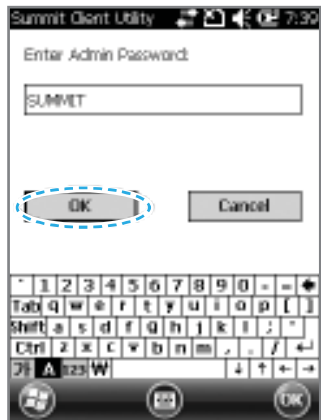

- ② Type in **SUMMIT**(Capitalized) in the password box and press **[OK]** button.



- ③ Select the **[Profile]** buttons on the bottom.



- ④ Select the **[Scan]** button on the top right.



- ⑤ A list of AP your device can connect to will appear. Connect to ex.) Platform_AP2. (Please select a desired AP) When the popup appears, Press [YES].



- ⑥ Type password in the box of the AP you wish to connect and press [OK] buttons.

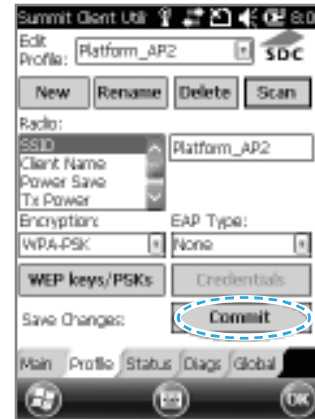

- ⑦ Once you press [Commit], you will be connected to the internet.

Device Specifications

Physical Characteristics

Dimensions (W x H x D)	75.8 x 154 x 28.6 mm / 2.9 x 6 x 1.1 inch
Weight	Including standard battery : 371g
Display	- 3.5" VGA with backlight, TFT LCD, 260K, 480 x 640 - 3.5" QVGA with backlight, TFT LCD, 260K, 240 x 320 (optional)
Keypad	Numeric / QWERTY / AZERTY / QWERTZ
Standard Battery	Rechargeable, 3.7V, 3,600mAh, Li-ion
Expansion Slot	MicroSD slot (up to 32GB)
SIM Slot	2 SIM
Audio	Speaker, Dual MIC Phone w/ noise cancellation, Bluetooth headset profile
Camera	5 megapixel color camera w/ LED flash
GPS	Integrated GPS w/ A-GPS

Data Capture

Barcode Scanner	1D&PDF417 Laser Class II or 1D&2D CMOS Imager
------------------------	---

Performance Characteristics

CPU	1GHz
OS	Windows Embedded Handheld 6.5 / Android
Memory	256MB RAM (optional 512MB) / 512MB ROM
Interface	RS-232C, USB 2.0 Host & Client via Snap-on

User Environment Characteristics

Operating temp	-20°C to 60°C
Storage Temp	-25°C to 70°C
Humidity	95% non-condensing
Drop Spec	6 ft. / 1.8m drop per MIL-STD 810G
Sealing Spec	IP65

Integrated Radio

WWAN Radio	3.8G GSM HSPA+/HSUPA or CDMA EVDO Rev A
WLAN Radio	IEEE 802.11a/b/g/n
WPAN Radio	Bluetooth Class II V2.1

Q Water went into my device. What do I do?

A First, remove your battery from the device and dry them in a dry place. After drying for a period of time try turning it on. If it still does not turn on, the main-board or other parts needs to be replaced. Please refer to your service center.

Q It won't turn on.

A The program may be damaged. Please try resetting your device. If it still doesn't work, refer to your service center.

Q It won't charge.

A Make sure the power cable and your device has been connected correctly. Try cleaning your charging terminals. If it still doesn't work, your battery life might be finished or it can be a broken battery. (The battery warranty is 6 menthes)

Q How do I get the repair service?

A You can send via a delivery service to the headquarters. When sending the package make sure you pay for the shipping fee in advance. When the repair is finished the headquarters will be covering the shipping fee.

Q My battery drains very quickly.

A The battery can be drained quickly when the Wi-Fi or Bluetooth is turned on. If it drains quickly regardless of using the options above, please purchase another battery.

- ※ If you have done the above and the device still does not work, please refer to the service center.
- ※ After the 1 year warranty the repair service will be charged.

Service Center

Before Requesting After-Sales Service

- Before asking for after-sales service, please back up the data from the terminal.
- We do not back up data from the products received in the Customer Care Center. Therefore, we assume no responsibility for loss/deletion of data.

Bluebird Soft Customer Service

- FAX : +82-2-548-0870
- E-Mail : gcs@bluebird.co.kr
- Address : 1242, Gaepo-dong, Gangnam-gu, Seoul, Korea

Operating hours

- Mon.-Fri. : 9:30 A.M. ~ 6:30 P.M. (GMT Time: +9 Hours)
- The center is closed on Saturdays, Sundays and holidays.

Registering for After-Sales Service

- We receive the products for after-sales service through mail, delivery service and hand carry only in principle.
- If you bought the product from any party other than the authorized dealer, you need to register the product before asking for after-sales service.
- Please enclose an evidence of purchasing or the receipt to the product for after-sales service.
- Please enclose the name, telephone number, address and symptom for prompt service.
- You can ask for after-sales service through the dealer or the Customer Care Center in the head office.
- Do not intentionally damage the label on the product.
- Damaged label may result in a disadvantage to the customer.
- When you return the product to Bluebird Soft for service, please put the product in a protective box.
- No warranty will not be provided for any damage occurring during delivery. We recommend you to use the box and protective cover supplied with the product.
- Make sure to deliver the product in a safe way. Bluebird Soft assumes no responsibility for loss of the product during delivery.

Charged Service

1. If it is not a default, it will be charged when requesting for after-sales service.
 - Service request due to inappropriate use of the customer
 - Loss of a PIN number
 - Use of programs that might effect the program (over-clock, forceful changes in the input of the system, personal developments)
2. Default due to a mistake on the part of the customer
 - Default due to inappropriate or careless use of the product (dropping, submersion under water, shock, damage, unreasonable operations, etc).
 - Default due to a repair or unauthorized technician.
 - Default caused intentionally or by carelessness of the customer.
 - Default due to the use of fraudulent parts or components.
3. Other cases
 - Default due to nature (fire, damage due to sea wind, flood damage, etc.).
 - Expendable parts have exhausted there life (batteries, antenna, or other component parts).

4. Regulations of treatment after charged service
 - If the same default occurs on the part that had been repaired within a 2 months(60 days) period, it will be provided with free of charge repair service.

There will be no returning of goods or repayment upon the following situation

- Removal of the sealing of the product if it had been sealed.
- If the product has been damaged due to careless use by the customer or due to a natural disaster (floods, rain, fire, etc.).
- Loss of product or other components (CD, diskette, manual, connecting cables, etc).
- Damage to the product after 10 days of purchase, the product will either be exchanged or provided with after-sales service (note, returning of goods or repayment is not allowed).

Warranty Certificate

Thank you for purchasing a product from Bluebird Soft Inc.

- If a circumstance arises where you lose a receipt or the certificate of guarantee, then the term of guarantee will be calculated 3 months (certified by the number of the manufacture, a certificate of inspection) after the date of manufacture.
- In case of accessories (such as batteries), only those that match the sales list managed by the service center will be eligible for customer service.
- A repair or an exchange of batteries that does not match the sales list of the service center due to the carelessness of the customer will be fully charged.

Name of Product	PDA
Name of Model	HM50
Date of Purchase	
Manufacture Number	
Place of Purchase	
Term of Guarantee	1 year from purchase

Warranty

1. Bluebird Soft Inc. (hereinafter referred to as Bluebird) provides the warranty service for its products in compliance with the regulations on compensation for damage of customer.
2. Upon receiving a notification on a defect of its product within the range of warranty during the warranty period, Bluebird will repair or replace the defective product according to its warranty policy.
3. If the defective product within the range of warranty is not repairable or replaceable, Bluebird shall refund the purchasing price within a designated period from the date of receiving a notice of defect.
4. Bluebird assumes no responsibility for repairing, replacement or refund until it receives the defective product from the customer. The replacement shall be equivalent to a new product in the aspect of performance.
5. Warranty of Bluebird is valid in the countries where the Bluebird products are distributed by Bluebird. (Contract for additional warranty service like field service)
6. Bluebird products may contain the recycled products, components or materials equivalent to new products in the aspect of performance.
7. This warranty is applied to software products only when the programming commands are not executed. Bluebird does not guarantee interruption-free or error-free performance.

User Information

This device may generate or use radio frequency energy. Changes or modifications to this equipment may cause harmful interference unless the modifications are expressly approved in the instruction manual. The user could lose the authority to operate this equipment if an unauthorized change or modification is made.

This equipment has been tested and found to comply with the limits for a Class B digital device, pursuant to Part 15 of the FCC Rules. These limits are designed to provide reasonable protection against harmful interference in a residential installation. This equipment generates uses and can radiate radio frequency energy and, if not installed and used in accordance with the instructions, may cause harmful interference to radio communications.

However, there is no guarantee that interference will not occur in a particular installation. If this equipment does cause harmful interference to radio or television reception, which can be determined by turning the equipment off and on, the user is encouraged to try to correct the interference by one or more of the following measures:

- Reorient or relocate the receiving antenna.
- Increase the separation between the equipment and receiver.
- Connect the equipment into an outlet on a circuit different from that to which the receiver is connected.
- Consult the dealer or an experienced radio/TV technical for help.
- Reorient or relocate the receiving antenna.
- Increase the separation between the equipment and receiver.
- Connect the equipment into an outlet on a circuit different from that to which the receiver is connected.
- Consult the dealer or an experienced radio/TV technical for help.

This device complies with Part 15 of the FCC's Rules. Operation is subject to the following two Conditions:

1. This device may not cause harmful interference, and
2. This device must accept any interference received, including interference that may cause undesirable operation.

We declare that this device is compliance with the essential requirements and other relevant provisions of directive 1999/5/EC.

CE 1177

FCC SAR information

This device is designed to meet the requirements for exposure to radio waves established by the Federal Communications Commission.

This device was tested for ear and body-worm operation in touch.

Bluebird

Customer Service Center

Working hours

Weekdays (9:30am ~ 6:30pm)

Saturdays and Sundays Closed

Phone Number: 1588-1380

Address: 1242 gaopo-dong kangnam-gu Seoul

Customer Service Center 1588-1380 we will do our best to satisfy your needs.