

Dual Radio 802.11a/n+b/g/n Indoor Access Point

BW1254

User's Guide v1.0

Copyright

© 2002-2013 BROWAN COMMUNICATIONS.

This USER GUIDE is copyrighted with all rights reserved. No part of this publication may be reproduced, transmitted, transcribed, stored in a retrieval system, or translated into any language in any form by any means without the written permission of BROWAN.

Notice

BROWAN reserves the right to change specifications without prior notice.

While the information in this document has been compiled with great care, it may not be deemed an assurance of product characteristics. BROWAN shall be liable only to the degree specified in the terms of sale and delivery.

The reproduction and distribution of the documentation and software supplied with this product and the use of its contents is subject to written authorization from BROWAN.

Trademarks

The product described in this book is a licensed product of BROWAN.

Microsoft, Windows 95, Windows 98, Windows Millennium, Windows NT, Windows 2000, Windows XP, Windows 7, and MS-DOS are registered trademarks of the Microsoft Corporation.

Novell is a registered trademark of Novell, Inc.

MacOS is a registered trademark of Apple Computer, Inc.

Java is a trademark of Sun Microsystems, Inc.

Wi-Fi is a registered trademark of Wi-Fi Alliance.

All other brand and product names are trademarks or registered trademarks of their respective holders.

Federal Communication Commission Interference Statement

This equipment has been tested and found to comply with the limits for a Class B digital device, pursuant to Part 15 of the FCC Rules. These limits are designed to provide reasonable protection against harmful interference in a residential installation. This equipment generates, uses and can radiate radio frequency energy and, if not installed and used in accordance with the instructions, may cause harmful interference to radio communications. However, there is no guarantee that interference will not occur in a particular installation. If this equipment does cause harmful interference to radio or television reception, which can be determined by turning the equipment off and on, the user is encouraged to try to correct the interference by one of the following measures:

- Reorient or relocate the receiving antenna.
- Increase the separation between the equipment and receiver.
- Connect the equipment into an outlet on a circuit different from that to which the receiver is connected.
- Consult the dealer or an experienced radio/TV technician for help.

FCC Caution: Any changes or modifications not expressly approved by the party responsible for compliance could void the user's authority to operate this equipment.

This device complies with Part 15 of the FCC Rules. Operation is subject to the following two conditions: (1) This device may not cause harmful interference, and (2) this device must accept any interference received, including interference that may cause undesired operation.

IMPORTANT NOTE:

Radiation Exposure Statement:

This equipment complies with FCC radiation exposure limits set forth for an uncontrolled environment. This equipment should be installed and operated with minimum distance 20cm between the radiator & your body.

This transmitter must not be co-located or operating in conjunction with any other antenna or transmitter.

Country Code selection feature to be disabled for products marketed to the US/CANADA
Operations in the 5.15-5.25GHz / 5.470 ~ 5.725GHz band are restricted to indoor usage only.

The band from 5600-5650MHz will be disabled by the software during the manufacturing and cannot be changed by the end user.

This device meets all the other requirements specified in Part 15E, Section 15.407 of the FCC Rules.

Contents

Copyright	1
Notice	1
Trademarks	1
CONTENTS	3
ABOUT THIS GUIDE.....	6
Purpose	6
Prerequisite Skills and Knowledge.....	6
Conventions Used in this Document.....	6
CHAPTER 1 – INTRODUCTION	7
Product Overview	7
Features Highlight	8
CHAPTER 2 - INSTALLATION	9
The Product Package.....	9
Hardware Introduction	9
General Overview	9
Front panel.....	9
Rear panel	10
Bottom Cover.....	10
Back label	11
Right side:	11
Left side	12
Connect to the Power Source and Local Network	12
Access to your access point.....	13
Configuration.....	13
CHAPTER 3 – REFERENCE MANUAL----AP MODE	15
Web Interface	15
Status	16
Status Device Status	16
Status Wireless Status.....	18
Status Dynamic Bridge Status	18
Status Interface Statistics	19
Network	20
Network Interface.....	20
Network Bridge	21
Network Attack Countermeasure.....	22
Network RADIUS Server	23
Network RADIUS Properties.....	27
Network DHCP.....	28
Network DHCP Lease.....	32
Network Link Integrity	32
Network WAPI Certificate Upload.....	34
Network Tr069 Settings	34
Wireless.....	37
Wireless Basic	37
Wireless Advanced	43
Wireless WEP	52
Wireless MAC ACL	54
Wireless Layer 2 Isolation(Inter-BSS).....	56

- Wireless | Neighbor List 58
- Wireless | Priority 5G 59
- User 61
 - User | Users 61
 - User | Station Supervision 63
- Services 64
 - Services | Telnet 64
 - Services | SNMP 65
 - Services | Time 66
 - Services | NTP 66
 - Services | Watchdog 69
- System 70
 - System | Administrator 70
 - System | System Log 71
 - System | System Mode 72
 - System | System Info 73
 - System | Configuration 74
 - System | Reset and Reboot 75
 - System | Local Upgrade 76
 - System | TFTP Upgrade 77
 - System | Location Settings 78
- CHAPTER 4 – REFERENCE MANUAL---AP-ROUTER MODE..... 79**
- Web Interface 79
- Status 81
 - Status | Device Status 81
 - Status | Wireless Status 82
 - Status | Interface Statistics 82
- Network 84
 - Network | Interface 84
 - Network | PPPoE 86
 - Network | L2TP 87
 - Network | RADIUS Server 89
 - Network | RADIUS Properties 93
 - Network | DNS 95
 - Network | DHCP 96
 - Network | DHCP Lease 99
 - Network | Static Route 99
 - Network | Attack Countermeasure 100
 - Network | Link Integrity 100
 - Network | Tr069 Settings 102
- Wireless 105
 - Wireless | Basic 105
 - Wireless | Advanced 111
 - Wireless | WEP 118
 - Wireless | MAC ACL 120
- User 123
 - User | Users 123
 - User | Station Supervision 125
 - User | User ACL 126
 - User | Walled Garden 128
 - User | WISP 129
 - User | Start Page 131
 - User | Customized UAM 132
 - User | Pages 136
 - User | Upload 138
 - User | HTTP Headers 138
 - User | Remote Authentication 139

Services.....	140
Services Telnet	140
Services SNMP	140
Services NTP	141
Services Time	144
Services Watchdog	144
System.....	146
System Administrator	146
System System Log	147
System System Mode	148
System System Info	149
System Configuration	150
System Reset and Reboot	151
System Local Upgrade	152
System TFTP Upgrade	153
System Location Settings	154
CHAPTER 5 – USER PAGES (BASED ON XSL).....	155
User Pages Overview.....	155
Welcome Page.....	155
Login Page.....	155
Logout Page.....	156
Help Page	157
Unauthorized Page	158
Example for External Pages	158
Example for Internal Pages	161
Extended UAM	164
Parameters Sent to WAS.....	166
CHAPTER 6 – CUSTOMIZED USER PAGE (HTML)	170
Set up your customized user page.....	170
FAQ	175
APPENDIX.....	176
A) Specification	176
B) Factory Defaults for the BW1254	177
Network Interface Configuration Settings	177
User Settings	179
System Settings	179
C) Location ID and ISO Country Codes	180

About this Guide

Purpose

This document provides information and procedures on hardware installation, setup, configuration, and management of the high performance Indoor Access Point BW1254.



Prerequisite Skills and Knowledge

To use this document effectively, you should have a working knowledge of Local Area Networking (LAN) concepts and wireless Internet access infrastructures. In addition, you should be familiar with the following:

- Hardware installers should have a working knowledge of basic electronics and mechanical assembly, and should understand related local building codes.
- Network administrators should have a solid understanding of software installation procedures for network operating systems under Microsoft Windows 95, 98, Millennium, 2000, NT, and Windows XP and general networking operations and troubleshooting knowledge.

Conventions Used in this Document

The following typographic conventions and symbols are used throughout this document:

	Very important information. Failure to observe this may result in damage.
	Important information that should be observed.
	Additional information that may be helpful but which is not required.
bold	Menu commands, buttons and input fields are displayed in bold
<code>code</code>	File names, directory names, form names, and system-generated output such as error messages are displayed in constant-width type
<value>	Placeholder for certain values, e.g. user inputs
[value]	Input field format, limitations, and/or restrictions.

Chapter 1 – Introduction

Thank you for choosing the Indoor Access Point BW1254.

The BW1254 is fully compliant to 802.11a/b/g/n standard and provides the flexibility of different kinds of 802.11n, 802.11a, 802.11g or 802.11b clients access to the BW1254. With the high speed data rate(Max. 300Mbps) and security, feature rich software functionality, it provides the high performance wireless connection for the SMB, enterprise, and hotspot of public area.

Product Overview

Flexibility and high performance

BW1254 is a high-performance and feature-rich indoor Access Point. It provides high quality connectivity for Wi-Fi networks designed to support large hotspots. The platform providing powerful hardware processing ability and maximize its service coverage for deploying enterprise-scale Wi-Fi networks including warehouses, universities, airports, hospitals, and large corporations.

- Support IEEE802.11a/b/g/n Wi-Fi standard.
- Wireless AP router mode: NAT, Different IP subnet per BSSID, Support DHCP server or client.
- FAT AP with AP or AP Router mode configuration.
- Point to point or smart point to multi-point bridge.

Secure and reliable wireless networking

BW1254 supports and meets industry security requirement of wide area networking professionals for secured wireless network:

- Supports VLAN, up to 16 VLAN ID
- IEEE 802.1x/EAP with password, certificates and SIM card
- 64bits/128bits static and dynamic WEP encryption
- Supports Wi-Fi Protected Access (WPA/WPA2) with AES and TKIP support
- Layer 2 Isolation for preventing snooping on the same BSS
- MAC address filtering (ACL) for preventing illegal attacking from Internet
- Hidden SSID broadcast to prevent illegal users connection
- Built-in Web login authentication (UAM, AP Router mode)

Strong Anti-interference

Dynamic Channel Allocation (DCA) solution automatically selects optimal operational frequency channel during power up and the periodically monitors the environment and adjusts for best operational channel. DCA enhances BW1254 performance and provide continuous coverage under high AP density wireless network environment.

Multiple BSSID “Virtual AP” Technology

Supports up to16 BSSID and each can be configured independently to support range of security policies, authentication model, RADIUS servers and VLAN IDs. Each BSSID also can be set different priority based on 802.1p tag or 802.11e EDCA which enables WLAN client device to access wireless link QoS capabilities.

Ease Installation and Deployment

Power option includes an integrated IEEE 802.3at Power-over-Ethernet port enables effortless deployment in various environments.

Easy and Secure Remote Management

BW1254 supports secure remote management through HTTPS, CLISH, SNMP and TR-069(DMS) management.

- Secure management via HTTPs, CLISH, SNMP
- Support TR-069 protocol
- Detail client survey and site survey
- Remote firmware update via WEB UI, BROWAN DMS server
- Backup/Restore configuration file
- Command Line Interface(CLI) with optional SSH
- Simple Network Management Protocol(V1,V2)

Features Highlight

- Support IEEE802.11a/b/g/n Wi-Fi standard.
- Superior Wireless Bridging Capability (PtP, PtMP)
- Support up to 16 BSSID – “Virtual AP”
- Wi-Fi Protected Access (WPA and WPA2) with TKIP or AES
- Wired Equivalent Privacy (WEP) using static or dynamic key of 64 or 128 bits
- Anti-Interference with Dynamic Channel Allocation (DCA)
- Hidden SSID for blocking illegal users accessing
- Supports 802.1x authentication using EAP-TLS, EAP-TTLS, PEAP, and SIM
- MAC Access Control List (ACL)
- Layer2 Isolation for Peer to Peer client access protection
- Built-in Web user login Authentication
- DHCP server, DHCP client
- Support up to 16 VLAN ID
- RADIUS authentication
- Wireless Quality of Service
- Backup/Restore configuration settings
- System Log, Save/Send System Log to remote log server with different log levels
- NTP for clock Synchronization
- Remote firmware upgrade via HTTP
- Remote secure management by HTTPS and SNMP
- Software watchdog supported

Chapter 2 - Installation

This chapter provides installation instructions for the hardware and software components of the Access Point BW1254. It also includes the procedures for the following tasks:

- Hardware Introduction (LEDs, Connectors)
- Connecting the Access Point
- Software Installation

The Product Package

The product comes with the following:

- Dual Radio 802.11a/n+b/g/n Indoor Access Point (model: BW1254)
- Screw Bag(wall mounting)
- Antenna (Dual-band Dipole Antennas with RP-SMA connector, 4 units)
- Ethernet patch cable (Cat5 UTP, 1.5m length, 1 unit)
- External power supply (Input:100-240VAC, 50-60Hz, Output: 48VDC/0.5A, 1 unit)

Hardware Introduction

General Overview



Figure 1 – BW1254 General View

Front panel

- There are five indicator lights (**LEDs**) that help to describe the state of various networking and connection operations.



Figure 2 – BW1254 led indication

▪ LED Indicators

LED	Indication
Power(Green)	ON: the unit is power on and ready to work Blinking : the device is booting Off : the unit is power off
Mode	Green : AP is working Blinking(both green and amber) : the AP is firmware upgrading
Ethernet	Green : network speed of 1000Mbps Amber : network speed of 10/100Mbps Off : Ethernet link is unavailable
WLAN 1(Green)	Blinking : the radio is operating Off : radio disable
WLAN 2(Green)	Blinking : the radio is operating Off : radio disable

table 1 – BW1254 led definition

Rear panel

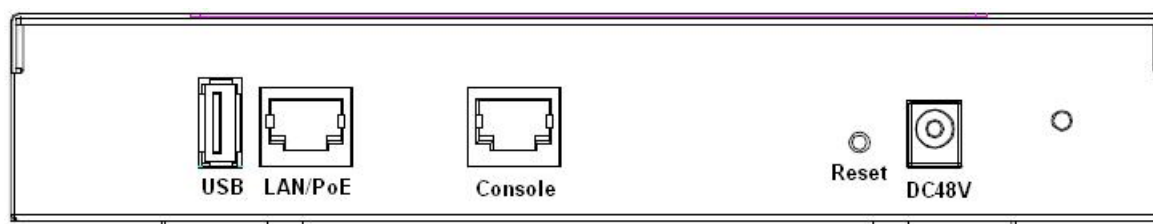

▪ Figure 3 – rear panel I/O port

-
- Descriptions of the connectors are given in the following table:

Item	Connector	Description
1	DC48V	For power supply 48V DC jack
2	Reset button	Reboot or Reset device Press reset button to reboot device or keep press for more than 5 seconds to reset factory default configuration.
3	Console	For console connection(RJ-45 interface)
4	LAN/PoE	Connecting RJ-45 cable to Ethernet network and for PoE power supply.
5	USB	reserved

▪ table 2 – BW1254 connectors

Bottom Cover

The Bottom Cover of the BW1254 contains:

1. **Back Label** with MAC address and S/N, model name, certification...etc.
2. **MAC address.** The label shows the **WLAN** interface MAC address of the device.
 WLAN 1:the radio MAC for 2.4G
 WLAN 2:the radio MAC for 5G
 The LAN MAC= WLAN 1 MAC + 1(Hex, AP mode)
 The WAN MAC=WLAN 1 MAC + 1(Hex, AP router mode)
3. **Serial Number** of the device.
4. **Rubber foot**
5. **Wall mount hole**

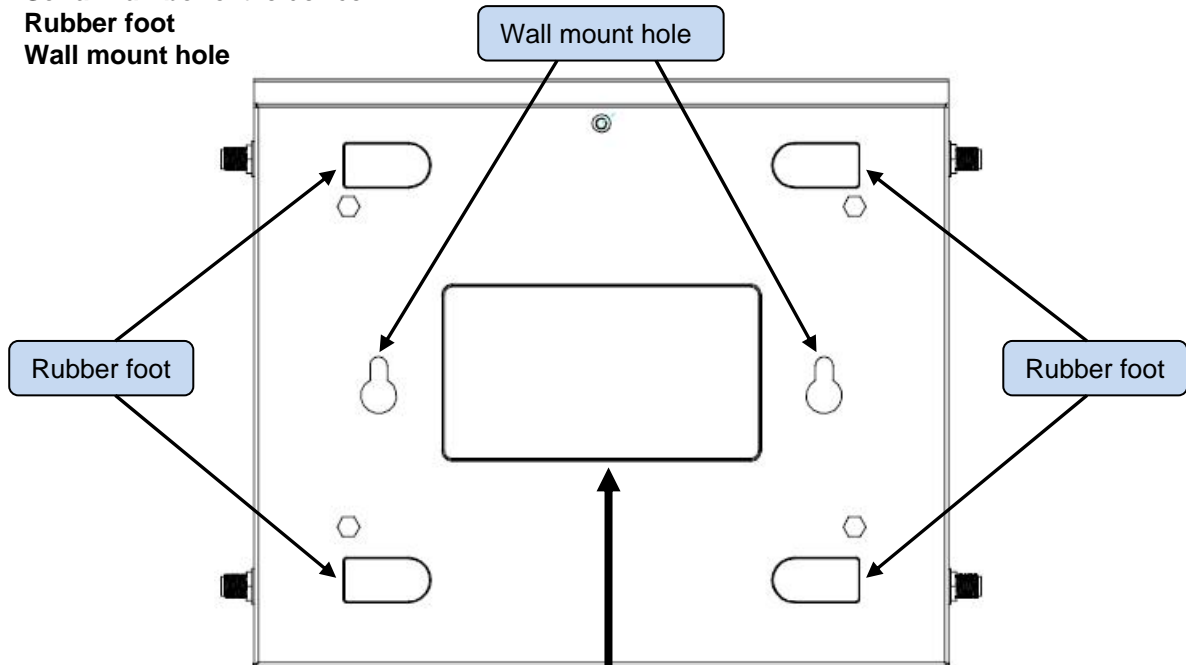

Figure 4 –Bottom Cover of the BW1254

Back label

The back label format and location as below.



Figure 5 – back label

Right side:

Two RP-SMA type of antenna connectors for WLAN 1(2.4G)

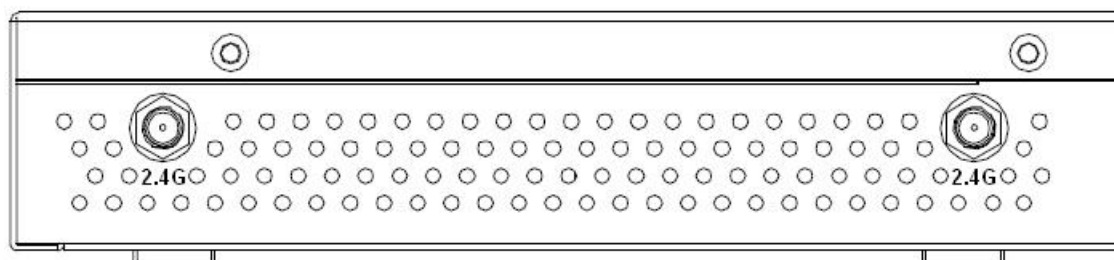

Figure 6 – SMA antenna connector(2.4G)

Left side

Two RP-SMA type of antenna connectors for WLAN 2(5G)

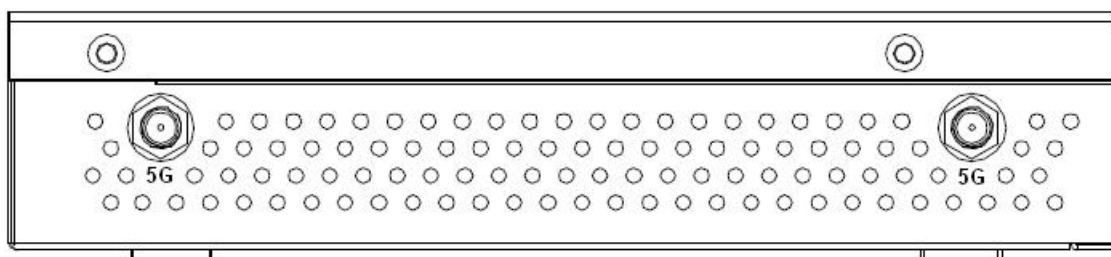

Figure 7 – RP-SMA antenna connector(5G)

Connect to the Power Source and Local Network

There are two power supply methods can be used by BW1254:

- ◆ Power-over-Ethernet equipment
- ◆ 48VDC Power adapter

Case 1 Use the BROWAN BE3013 PoE injector+DC 48V power adapter:

	BE3013 PoE injector is optional which is non-compliant to 802.3at. BW1254 is compliant to 802.3at PoE standard.
--	---

Step 1 Place the Access Point on a flat work surface or hang on the wall.

	Use the enclosed 2 screws mounting the Access Point to the wall if necessary.
--	---

Step 2 Connect DC 48V power supply to PoE injector DC jack.

Step 3 Connect the Ethernet cable from the BW1254 to PoE injector “P+data” out port.

Step 4 Connect Ethernet cable from PoE injector “data in” port to the computer or through LAN switch connect to your local network. Please refer to the figure shown as below.

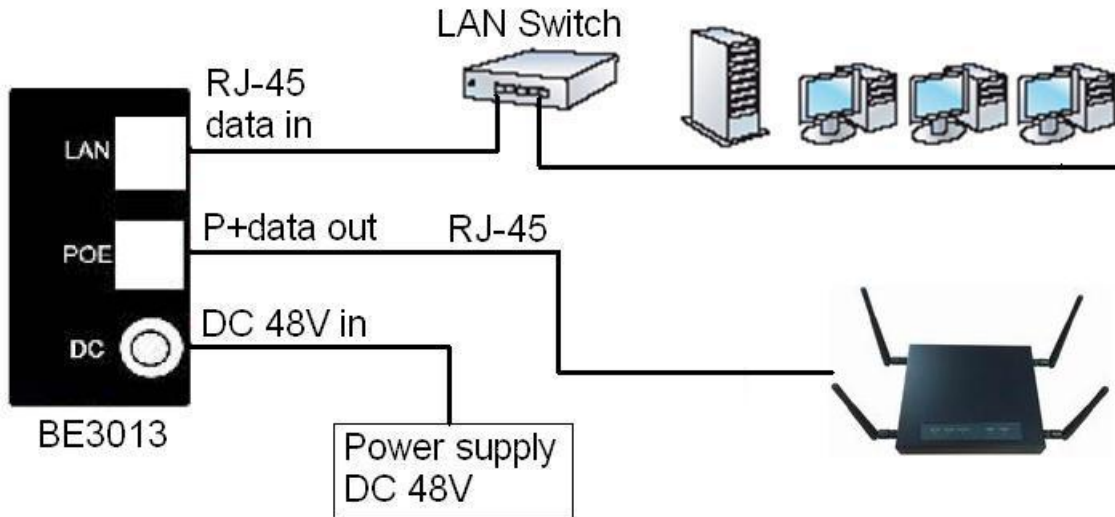

Figure 8 – Connecting BW1254 to Power source and network by PoE

Case 2 Use External Power Supply

- Step 1** Place the Access Point on a flat work surface or hang on the wall.
- Step 2** Use the enclosed Ethernet patch cable to connect the LAN port of the Access Point to the Switch or hub in the local network.
- Step 3** Connect the power supply to the Access Point.

Access to your access point

Configuration

Now it is ready to access and configure your access point. Open web browser and enter ip address. The default ip address for your new access point is:

IP 192.168.2.2 subnet 255.255.255.0

- Step 1** Configure your PC with a static IP address on the 192.168.2.x subnet with mask 255.255.255.0. Connect the BW1254 into the same physical network as your PC. Open the Web browser and type the default IP address of the BW1254:

<https://192.168.2.2/a.rg>

- Step 2** Enter the BW1254 administrator login details to access the Web management.

	The default administrator log on settings for all access point interfaces are: User Name: admin Password: admin01
---	---

Continuously clicking Yes to proceed.



Figure 9 – Security alert



Figure 10 – login page

Step 3 After successful administrator log on you will see the main page of the BW1254 **Web interface:**

Figure 11 – Web interface Management Menu

Now you are enabled to perform your configuration.

Chapter 3 – Reference Manual----AP Mode

This chapter describes the configuration of the BW1254 which works in AP mode using the Web Interface.



The BW1254 Web Interface in AP mode is different from that in AP-Router mode. To change your BW1254 to AP-Router mode, please refer to **System | System Mode** . For the detailed configuration of BW1254 working in AP-Router mode, please refer to the next chapter: **Chapter 4 – Reference Manual----AP-Router Mode**

The **web management** main menu consists of the following sub menus:

- **Status** – device status showing
- **Network** – device settings affecting networking
- **Wireless** – device settings related to the wireless part of the BW1254
- **User** –device settings affecting the user interface
- **Services** – networking service settings of the BW1254
- **System** – device system settings directly applicable to the BW1254
- **Exit** – click exit and leave the web management then close your web-browser window.

Web Interface

The main **web management** menu is displayed at the top of the page after successfully logging into the system (see the figure below). From this menu all essential configuration pages are accessed.



Figure 12 – Main Configuration Management Menu

The **web management** menu has the following structure:

Status

- Device Status** – show the status related with the whole device
- Wireless Status** – show the status of the two radios
- Dynamic Bridge Status** – show the dynamic bridge status of the two radios
- Interface Statistics** – show the status of each network interface

Network

- Interface** – TCP/IP settings of BW1254 LAN (Bridge) port
- Bridge** – 802.1d settings of BW1254 bridge port
- Attack Countermeasure** – Anti-attack settings for protecting BW1254
- RADIUS Server** – specify the accounting/authentication RADIUS server which is used by 802.1x or WPA
- RADIUS Properties** – specify the settings of the RADIUS properties, includes NAS server ID, RADIUS Retries and other settings
 - DHCP** – specify the settings of DHCP server service
 - DHCP lease** – display the DHCP lease information
 - Link Integrity** – specify the status and settings of link integrity feature.

WAPI Certificate Upload – configure the WAPI certificate

Tr069 settings – configure the remote management through TR069 ACS server(BROWAN DMS server)

Wireless

Basic – specify the basic settings related with wireless part

Advance – specify the settings of multiple BSSID or Bridge

WEP – specify the WEP settings related with static WEP encryption

MAC ACL – MAC ACL settings for BW1254

Layer 2 Isolation – Inter-BSS layer2 Isolation settings of BW1254

Neighbor list – scan the neighbor AP of 2.4G/5G

Priority 5G – configure the 5G priority

User

Users – show the connected users' statistics list and log-out user function

Station Supervision – monitor station availability with ARP-pings settings

Services

Telnet – Telnet/SSH service

SNMP – SNMP service

Time – manually set time

NTP – NTP settings of BW1254

Watchdog – Enable the S/W or H/W watchdog of BW1254

System

Administrator – set access permission to your BW1254

System Log – check the system log locally or specify address where to send system log file

System Mode – specify whether the BW1254 works in AP mode or in AP router mode

System Info – specify some device related information for BW1254

Configuration – system configuration utilities, including Backup/Upload configuration

Reset & Reboot – reboot device and restore systems to factory default

Local Upgrade – upgrade firmware from local PC

TFTP Upgrade –upgrade firmware from tftp server

Location settings – define AP location(Longitude/Latitude)

In the following sections, short references for all menu items are presented.

Status

Status | Device Status

The **Device Status** page shows important information of system status and network configuration for the BW1254.

System	
System Mode	AP
System Version	BW1254.BRO.2.0.01
Config Version	BW1254.BRO.2.0.01
Up Time	0 day(s) 00:08
System Time	1970/01/01/ 00:08
WLAN1 MAC	00:16:16:20:40:68
WLAN2 MAC	20:10:7A:D3:B2:95
Free System Memory	11,068 K bytes
Total System Memory	47,524 K bytes

Network	
LAN Mode	static-IP
LAN MAC	00:16:16:20:40:69
LAN IP	192.168.21.165
LAN Mask	255.255.255.0
Gateway	192.168.21.1
VLAN	Disabled
VLAN ID	

Figure 13 – Device Status

System Mode – display whether the BW1254 works in AP mode or AP-Router mode

System Version display the current firmware version

	This is important information for support requests and for preparing firmware upgrading
---	---

Config version – display current configure version

Up Time – indicate the time, expressed in days, hours and minutes since the system was last rebooted

System Time – show the current time of the BW1254

Wlan1 MAC – show the MAC addresses of the wireless interfaces(2.4G) of the BW1254

Wlan2 MAC – show the MAC addresses of the wireless interfaces(5G) of the BW1254

Free System Memory – indicate the memory currently available in the BW1254

Total System Memory – indicate the total memory in the BW1254

LAN Mode – indicate static IP or DHCP client is used for BW1254 LAN IP address

LAN MAC – display the Ethernet MAC address

LAN IP – show the LAN IP address of BW1254

LAN Mask – show the LAN Network Mask of BW1254

Gateway – show the default gateway of BW1254

VLAN – show the status of LAN Interface VLAN of BW1254

VLAN ID – display VLAN ID if configure the VLAN

Status | Wireless Status

The *wireless status* shows the information related with BW1254 wireless interfaces.

Radio1	
Channel	Current Frequency=2.437 GHz (Channel 6)
Domain	FCC
Mode	AP
Band	2.4GHz(11n HT20/40plus)
Total Connected Clients	1
Total Output Power (EIRP)	10dBm
MAC ACL	disabled
SSID Number	2

Radio2	
Channel	Current Frequency=5.745 GHz (Channel 149)
Domain	FCC
Mode	AP
Band	5GHz(11n HT20/40plus)
Total Connected Clients	0
Total Output Power (EIRP)	10dBm
MAC ACL	disabled
SSID Number	2

Figure 14 – Wireless Status

Radio1/Radio2 –wireless interfaces

Channel – indicate which channel is in use.

Domain – indicate regulatory domain set on the BW1254

Mode – AP or Bridge mode is be used for this wireless interface

Band – specify which band is in use for wireless interface

Total Connected Clients – indicate number of the currently connected clients to your BW1254

Tx Power – indicate radio transmit power of the BW1254

MAC ACL – indicate the status of MAC ACL feature on BW1254

SSID Number – indicate current number of enabled SSID on BW1254

Status | Dynamic Bridge Status

The *Dynamic Bridge status* shows the status of wireless bridge links.

Dynamic Bridge Connected Links						
Index	Radio	RadioAddr	DevAddr	NetID	SNR	Up/Down Link
<input type="button" value="Refresh"/>						

Status | Interface Statistics

The *Interface Statistics* shows each network interface status, including Input / Output bytes, packets or error.

Interface Statistics						
Interface Name	Input Bytes(KB)	Input Packets	Input Errors	Output Bytes(KB)	Output Packets	Output Errors
eth1	86	1077	0	70	166	0
<input type="button" value="Refresh"/>						

Figure 15 – Interface Statistics

Interface Name – show the name of each network interface, where `ixp0` is related to LAN interface, `wlan1_x` is related to wireless sub-interface.

Input Bytes (KB) – show the total number of bytes received on the network interface. The bytes number is displayed in KB.

Input Packets – show the packets number received on the network interface.

Input Errors – show the packets number which contain errors preventing them from being received correctly.

Output Bytes (KB) – show the total number of bytes transmitted out of the network interface. The bytes number is displayed in KB.

Output Packets – show the packets number transmitted out of the network interface.

Output Errors – show the packets number which contain errors preventing them from being transmitted out correctly.

Refresh – get the updated network interface information.

Network

Network | Interface

Interface						
IP Address	Netmask	Gateway Address	Protocol	VLAN	VLAN ID	Action
192.168.2.2	255.255.255.0	192.168.2.1	static	Disabled		Edit

Figure 16 – Interface Configuration Table

To change network interface configuration properties click the **Edit** button in the **Action** column. The **status** can be changed now:

Interface						
IP Address	Netmask	Gateway Address	Protocol	VLAN	VLAN ID	Action
<input type="text" value="192.168.2.2"/>	<input type="text" value="255.255.255.0"/>	<input type="text" value="0.0.0.0"/>	<input type="text" value="static"/>	<input type="text" value="Disabled"/>	<input type="text" value="(1 - 4094)"/>	Save Cancel

Figure 17 – Edit Interface Configuration Settings

IP Address – specify new interface IP address [in digits and dots notation, e.g. 192.168.2.2].

Netmask – specify the subnet mask [[0-255].[0-255].[0-255].[0-255]]. These numbers are a binary mask of the IP address, which defines IP address order and the number of IP addresses in the subnet

Gateway Address – interface gateway. For Bridge type interfaces, the gateway is always the gateway router

Protocol – specify **static** for setting IP address manually and **dhcp** for getting IP address dynamically acting as DHCP client

VLAN – Enable or disable VLAN on LAN (bridge) interface

VLAN ID – When enabled **VLAN**, specify the VLAN ID of it

Save – save the entered values.

Cancel – restore all previous values.

Change status or leave in the default state if no editing is necessary and click the **Save** button.

Interface						
IP Address	Netmask	Gateway Address	Protocol	VLAN	VLAN ID	Action
192.168.2.2	255.255.255.0	192.168.2.1	static	Disabled		Edit

[Apply Changes](#) [Discard Changes](#)

Figure 18 – Apply or Discard Interface Configuration Changes

Apply Changes – save all changes in the **interface** table at once.

Discard Changes – restore all previous values.

For such change of settings, the BW1254 needs to be restarted to apply all settings changes when clicking **Apply Changes**. Request for reboot server appears:

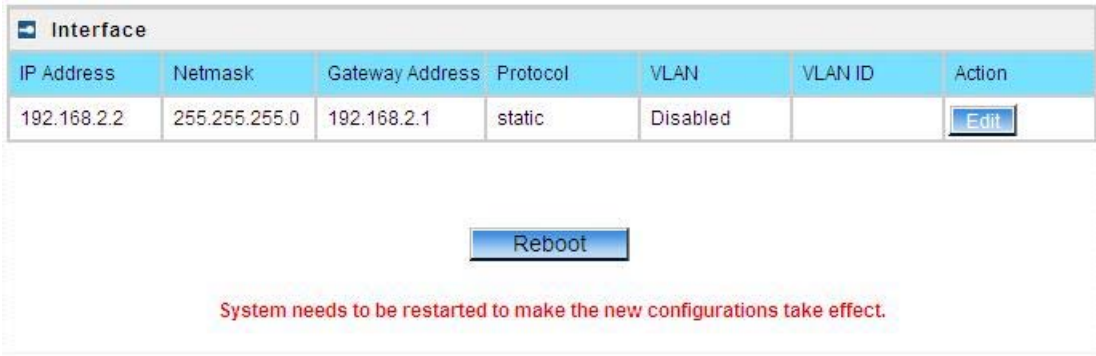

Figure 19 – Reboot Server

Reboot – click the button to restart the server and apply the changes.

i

If there is no other settings needed to be modified, click the **Reboot** button to apply all changes. If there are any other settings need to be changed, continuously to finish and apply all changes and then click **Reboot** button to restart and take effect for all settings.

To reboot at once, click **Reboot** button and then it is necessary to wait a moment. And the message of reboot appears just like bellows:

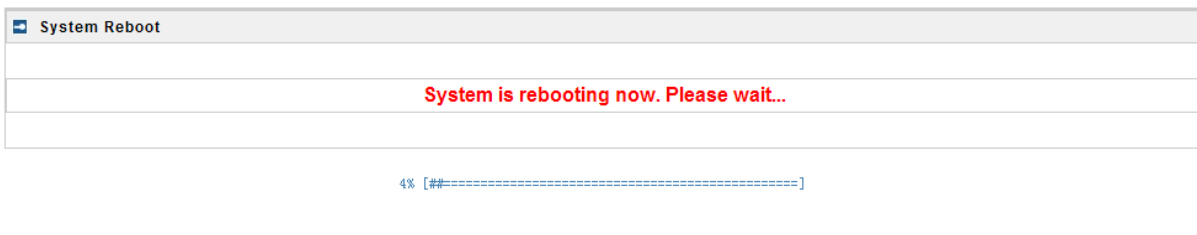

Figure 20 – Reboot Information

Network | Bridge

The Spanning Tree Protocol is a network protocol that ensures a loop-free topology for any bridged Ethernet local area network. The basic function of STP is to prevent bridge loops and the broadcast radiation the results from them.

Specify STP(spanning tree protocol) status of 802.1d bridge here.



Figure21– 802.1d bridge STP settings

STP Status – Enable or disable the 802.1d STP for BW1254

Clicking **Edit**, the follow UI will be appear:



Figure 22 – Edit bridge settings

Save – save the entered values.

Cancel – restore all previous values.

Click **Save** button for applying the changes that modified.

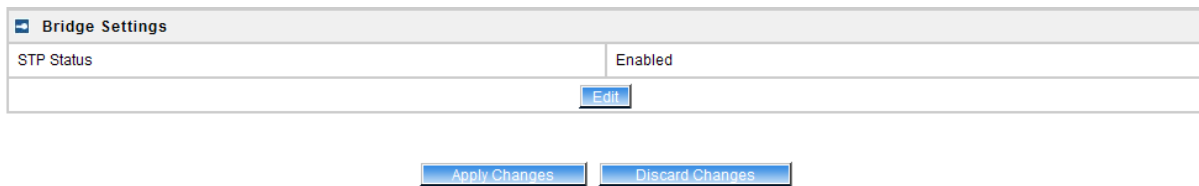

Figure 23 – Apply or Discard Bridge Settings Changes

Apply Changes – save all changes at once

Discard Changes – restore all previous values.

Click **Apply Changes** and then follow the instruction to reboot the device for all modified settings applied.

If there is no other settings needed to be modified, click the **Reboot** button to apply all changes. If there are any other settings need to be changed, continuously to finish and apply all changes and then click **Reboot** button to restart and take effect for all settings.

Network | Attack Countermeasure

To protect BW1254 from outside attack, anti-attack polices can be set here based on network needs.

Attack Countermeasure					
Item	Status	Max Load	Duration(seconds)	Expire(seconds)	Action
Anti-DOS	Disabled	400 TCP links/s		300	Edit
Flow Control	Disabled	20480 Kbps	60	300	Edit

Figure 24– Attack Countermeasure settings

Anti-DOS

Status – Enable or disable anti-dos policy for BW1254. This policy is for TCP DOS attack.

Max Load – The attack threshold. BW1254 think there is TCP DOS attack and do the countermeasure if one client’s TCP links exceed this threshold.

Expire(seconds) – If one client is considered as DOS attacker, BW1254 kicks it out and doesn’t let it connect again during the time that **Expire** set.

Flow Control

Status – Enable or disable traffic flow control policy for BW1254.

Max Load – The attack throughput threshold.

Duration(seconds) – if traffic exceeds the value of **Max Load** during the whole time that **Duration** set, BW1254 think there is traffic flow attack and implement the countermeasure.

Expire(seconds) – If one client is considered as traffic flow attacker, BW1254 kicks it out and doesn’t let it connect again during the time that **Expire** set.

Network | RADIUS Server

	Up to 32 different RADIUS servers can be configured in the RADIUS servers menu.
---	---

By default, one **RADIUS** server is specified for the system:

RADIUS Server					
Name	Type	IP Address	Port	Secret	Action
DEFAULT (default)	Authentication	0.0.0.0	1812	secret	Details Edit Delete
	Accounting	0.0.0.0	1813	secret	
Add					

Figure 25 – RADIUS Servers Settings

Details – show the detail information of this **RADIUS Server** profile

Edit – edit the selected **RADIUS Server** entry you want to configure

Delete – delete the selected **RADIUS Server** entry. The last entry can not be deleted

Add – add new RADIUS server.

Click **Details**, a similar page will be appeared as below:

RADIUS Server	
Description	Value
Name (default)	DEFAULT
Authentication IP	192.168.123.200
Authentication Port	1812
Authentication Secret	secret
Accounting IP	192.168.123.201
Accounting Port	1813
Accounting Secret	secret
User Password Md5sum Secret	disabled
Back Edit	

Figure 26 – Detail for Radius Server profile

Name – the new RADIUS server name which is used for selecting RADIUS server

	If a “(default)” appears on the right side of the Name entry, it means this RADIUS server profile is the default profile.
---	--

Authentication IP – show the IP address of Authentication RADIUS server

Authentication Port – show the network port used to communicate with the Authentication RADIUS server

Authentication Secret – show the shared secret string that is used to make sure the integrity of data frames used for the Authentication RADIUS server

Accounting IP – show the IP address of Accounting RADIUS server

	If the Accounting IP address is 0.0.0.0, it means that the Accounting service is disabled.
---	--

Accounting Port – show the network port used to communicate with the Accounting RADIUS server

Accounting Secret – show the shared secret string that is used to make sure the integrity of data frames used for the Accounting RADIUS server

User Password Md5sum Secret – show whether user input password is calculated md5-sum before pass to RADIUS server or not.

Back – back to the **RADIUS Server** main page

Edit – edit the selected **RADIUS Server** profile

Click **Edit** or click **Add / Edit** button in the main page to configure RADIUS server settings.

RADIUS Server	
Description	Value
Name	<input type="text" value="DEFAULT"/>
Default	<input checked="" type="checkbox"/>
Authentication IP	<input type="text" value="192.168.123.100"/>
Authentication Port	<input type="text" value="1812"/>
Authentication Secret	<input type="text" value="secret"/>
Accounting IP	<input type="text" value="192.168.123.200"/>
Accounting Port	<input type="text" value="1813"/>
Accounting Secret	<input type="text" value="secret"/>
User Password Md5sum Secret	<input type="text" value="disabled"/> ▼
<input type="button" value="Save"/> <input type="button" value="Cancel"/>	

Figure 27 – Edit the RADIUS Server's profile

RADIUS Server	
Description	Value
Name	<input type="text"/>
Default	<input type="checkbox"/>
Authentication IP	<input type="text"/>
Authentication Port	<input type="text"/>
Authentication Secret	<input type="text"/>
Accounting IP	<input type="text"/>
Accounting Port	<input type="text"/>
Accounting Secret	<input type="text"/>
User Password Md5sum Secret	disabled <input type="button" value="v"/>
<input type="button" value="Save"/> <input type="button" value="Cancel"/>	

Figure 28 – Add a new RADIUS Server's profile

Name – specify the new RADIUS server name which is used for selecting RADIUS server

Default – specify this RADIUS profile as default or not. When selected, the profile will be used as default

Authentication IP – specify the IP address of Authentication RADIUS server [dots and digits]

Authentication Port –specify the network port used to communicate with the Authentication RADIUS server [1-65535]

Authentication Secret – shared secret string that is used to make sure the integrity of data frames used for the Authentication RADIUS server

Accounting IP – specify the IP address of Accounting RADIUS server [dots and digits]

Accounting Port –specify the network port used to communicate with the Accounting RADIUS server [1-65535]

Accounting Secret – shared secret string that is used to make sure the integrity of data frames used for the Accounting RADIUS server

	<p>The default port value for authentication is 1812. The default port value for accounting is 1813. The port specified here must be the same with the one on the RADIUS server.</p>
---	--

User Password Md5sum Secret – if enabled, user input password will be calculated md5-sum before pass to RADIUS server for more security [enabled/disabled]

	<p>This setting needs RADIUS server implement relevant configurations.</p>
---	--

Save –save the entered values

Cancel – restore all previous values

After adding a new RADIUS server or editing an existing one, a page appears similar to the following:

RADIUS Server					
Name	Type	IP Address	Port	Secret	Action
DEFAULT (default)	Authentication	192.168.123.100	1812	secret	Details Edit Delete
	Accounting	192.168.123.200	1813	secret	
Add					

[Apply Changes](#)
[Discard Changes](#)

Figure 29 – Apply or Discard RADIUS Server Changes

Details – show the detail information of this **RADIUS Server** profile

Edit – edit the selected **RADIUS Server** entry you want to configure

Delete – delete the selected **RADIUS Server** entry. The last entry can not be deleted

Add – add new RADIUS server.

Apply Changes – to save all changes at once.

Discard Changes – restore all previous values.

Click **Apply Changes** to apply all the changes. Then the follow similar page will appear:

RADIUS Server					
Name	Type	IP Address	Port	Secret	Action
DEFAULT (default)	Authentication	192.168.123.100	1812	secret	Details Edit Delete
	Accounting	192.168.123.200	1813	secret	
Add					

[Reboot](#)

System needs to be restarted to make the new configurations take effect.

Figure 30 – Reboot Server

Reboot – restart the access point to make applied changes work.

	<p>If there is no other settings needed to be modified, click the Reboot button to apply all changes. If there are any other settings need to be changed, continuously to finish and apply all changes and then click Reboot button to restart and take effect for all settings.</p>
---	--

Network | RADIUS Properties

General **RADIUS** settings are configured using the **RADIUS Properties** menu under the **network**:

RADIUS Properties		
Setting	Value	Action
RADIUS Retries	5	Edit
RADIUS Timeout (seconds)	2	Edit
NAS Server ID		Edit
User Session Timeout (seconds)	72000	Edit
User Accounting Update Interval (seconds)	600	Edit
User Accounting Update Retry (seconds)	60	Edit
User Idle Timeout (seconds)	900	Edit

Figure 31 – RADIUS Properties settings

RADIUS Retries – retry count of sending RADIUS packets before giving up [0-99]

RADIUS Timeout (seconds) – maximum amount of time before retrying RADIUS packets [1-999]

NAS Server ID – name of the RADIUS client

User Session Timeout (seconds) – amount of time from the user side (no network carrier) before closing the connect [1-999999999]

User Accounting Update Interval (Seconds) – period after which server should update accounting information [60-999999999]

User Accounting Update Retry (seconds) – retry time period in which server should try to update accounting information before giving up [60-999999999]

User Idle Timeout (seconds) – amount of user inactivity time, before automatically disconnecting user from the network [1-999999999]

Each setting in this table can be edited. Select **RADIUS** setting you need to update, click the **edit** next to the selected setting and change the value:

RADIUS Properties		
Setting	Value	Action
RADIUS Retries	<input type="text" value="5"/>	Save Cancel
RADIUS Timeout (seconds)	2	
NAS Server ID		
User Session Timeout (seconds)	72000	
User Accounting Update Interval (seconds)	600	
User Accounting Update Retry (seconds)	60	
User Idle Timeout (seconds)	900	

Figure 32 – edit RADIUS properties

Use the **save** button to save an entered value. Now select another **RADIUS** property to edit, or **Apply Changes** and restart your AP if the configuration is finished:

RADIUS Properties		
Setting	Value	Action
RADIUS Retries	5	Edit
RADIUS Timeout (seconds)	2	Edit
NAS Server ID		Edit
User Session Timeout (seconds)	72000	Edit
User Accounting Update Interval (seconds)	600	Edit
User Accounting Update Retry (seconds)	60	Edit
User Idle Timeout (seconds)	900	Edit

[Apply Changes](#) [Discard Changes](#)

Apply Changes – click if **RADIUS Properties** configuration is finished

Discard Changes – restore all previous values

Network | DHCP

In AP mode, BW1254 can act as DHCP server. The DHCP (Dynamic Host Configuration Protocol) service is supported on layer 2 interfaces.

DHCP server and DHCP relay are disabled by default.

DHCP	
Name	Value
Status	Disabled
Edit	

Figure 33 – DHCP Settings

Edit – edit the DHCP settings

To enable DHCP server click the **Edit** button.

DHCP	
Name	Value
Status	<div style="border: 1px solid gray; padding: 2px;"> Disabled ▼ </div> <div style="border: 1px solid gray; padding: 2px; margin-top: 2px;"> Disabled DHCP Server </div>
Edit	

Figure 34 – DHCP Settings

Status – select status from the drop-down menu.

Disabled – disable the DHCP server service.

DHCP Server – enable the DHCP server service.

Choose DHCP Server to enable DHCP server service.

DHCP Server

This DHCP server service enables clients on the LAN to request configuration information, such as IP address, from a server. Settings of the DHCP service can be viewed just like the follow page.

DHCP	
Name	Value
Status	DHCP Server <input type="button" value="v"/>
IP Address from	<input type="text" value="192.168.123.2"/>
IP Address to	<input type="text" value="192.168.123.254"/>
Netmask	<input type="text" value="255.255.255.0"/>
Gateway	<input type="text" value="192.168.123.1"/>
WINS Address	<input type="text" value="0.0.0.0"/>
Lease Time (seconds)	<input type="text" value="864000"/>
Domain	<input type="text"/>
DNS Address	<input type="text" value="0.0.0.0"/>
DNS Secondary Address	<input type="text" value="0.0.0.0"/>
<input type="button" value="Save"/> <input type="button" value="Cancel"/>	

Figure 35 – DHCP server Settings

	By default, DHCP server is disabled.
---	--------------------------------------

IP Address from / IP Address to – specify the IP address range to be dynamically allocated by the DHCP server.

Netmask – enter the netmask for IP pool range.

Gateway – enter the gateway IP for wireless clients.

WINS Address (Windows Internet Naming Service) – specify server IP address if it is available on the network [dots and digits].

Lease Time – specify the IP address lease interval in seconds [1-1000000].

Domain – specify the DHCP domain name [optional, 1-128 sting].

DNS address – specify the DNS server’s IP address [in digits and dots notation].

DNS secondary address – specify the secondary DNS server’s IP address [in digits and dots notation].

Change status or leave in the default state if no editing is necessary and click the **Save** button.

DHCP	
Name	Value
Status	DHCP Server
IP Address from	192.168.123.2
IP Address to	192.168.123.254
Netmask	255.255.255.0
Gateway	192.168.123.1
WINS Address	0.0.0.0
Lease Time (seconds)	864000
Domain	
DNS Address	0.0.0.0
DNS Secondary Address	0.0.0.0
Edit	

[Apply Changes](#) [Discard Changes](#)

Figure 36 – Apply or Discard DHCP server Settings

	The DHCP server settings will be automatically adjusted to match the network interface settings.
---	--

	The Gateway of DHCP server settings must be same with the Gateway of BW1254
---	---

For each change of settings, the BW1254 needs to be restarted to apply all settings changes when clicking **Apply Changes**. Request for reboot server appears:

DHCP	
Name	Value
Status	DHCP Server
IP Address from	192.168.123.2
IP Address to	192.168.123.254
Netmask	255.255.255.0
Gateway	192.168.123.1
WINS Address	0.0.0.0
Lease Time (seconds)	864000
Domain	
DNS Address	0.0.0.0
DNS Secondary Address	0.0.0.0
<input type="button" value="Edit"/>	

System needs to be restarted to make the new configurations take effect.

Figure 37 – Reboot information

Reboot – click the button to restart the server and apply the changes.

	<p>If there is no other setting needed to be modified, click the Reboot button for applying all modifications.</p> <p>And if there are still other setting modifications needed, go ahead to finish all changes and then click Reboot button to restart and apply all settings together.</p>
---	--

	<p>When BW1254 network Interface uses DHCP to get IP address dynamically, DHCP server service cannot be enabled.</p>
---	--

When BW1254 uses DHCP to get IP address, the similar WEB UI will be appeared:

Warning: DHCP server and DHCP relay cannot be set when AP as a DHCP client itself.

DHCP	
Name	Value
Status	Disabled

Figure 38 – Warning information

Network | DHCP Lease

This page display the DHCP lease information of wireless client which connect to the AP when DHCP server enable.

DHCP Lease			
Host Name	Mac Address	IP Address	Expires in
ggyy-40fbc8fbae	00:13:02:01:14:5a	192.168.2.4	9 d 23 h 59 m 24 s
<input type="button" value="Refresh"/>			

Figure 39 – DHCP lease information

Host Name – the host name of wireless client which associate to the access point.

Mac Address –the MAC address of wireless client which associate to the access point.

IP Address –the IP address of wireless client which associate to the access point.

Expires in – expire time of the wireless client which associate to the access point.

Network | Link Integrity

Specify Link Integrity feature’s settings here. Enable Link Integrity, BW1254 will close wireless connections and kick out all the wireless clients when it detects that its Ethernet network cannot be accessed to the internet.

Link Integrity	
Name	Status
Status	Disabled
<input type="button" value="Edit"/>	

Figure 40 – Link Integrity settings

Click **Edit** button to set the Link Integrity settings, the similar UI will be appeared as below:

Link Integrity	
Name	Status
Status	Enabled <input type="button" value="v"/>
Target IP1	<input type="text" value="0.0.0.0"/>
Target IP2	<input type="text" value="0.0.0.0"/>
Target IP3	<input type="text" value="0.0.0.0"/>
Target IP4	<input type="text" value="0.0.0.0"/>
Target IP5	<input type="text" value="0.0.0.0"/>
<input type="button" value="Save"/> <input type="button" value="Cancel"/>	

Figure 41 – Edit Link Integrity settings

Status – Enable or disable the feature of Link Integrity

Target IP1 to Target IP5 – IP addresses for BW1254 detecting if its Ethernet interface can access network. The AP will ping every IP address 15 times in sequence. As long as one ping is successful it will consider the network is no problem. If ping fail for all IP address specified it will consider Ethernet link fail and all associated wireless client will be logged out. The AP will continue to ping from first IP address. If ping success the wireless client will access AP again.

Save – save the entered values.

Cancel – restore all previous values.

Click **Save**, the similar apply changes UI will be appeared:

Link Integrity	
Name	Status
Status	Enabled
Target IP1	192.168.123.69
Target IP2	192.168.123.1
Target IP3	0.0.0.0
Target IP4	0.0.0.0
Target IP5	0.0.0.0

Figure 42 –Apply or Discard Link Integrity Settings

Apply Changes – save all changes in the **interface** table at once.

Discard Changes – restore all previous values.

	Maximum 5 target IP can be specified.
---	---------------------------------------

The BW1254 needs to be restarted to apply all settings changes when clicking **Apply Changes**. Request for reboot server appears:

Link Integrity	
Name	Status
Status	Enabled
Target IP1	192.168.123.69
Target IP2	192.168.123.1
Target IP3	0.0.0.0
Target IP4	0.0.0.0
Target IP5	0.0.0.0

System needs to be restarted to make the new configurations take effect.

Figure 43 – Reboot Server

Reboot – click the button to restart the server and apply the changes.

	If there is no other settings needed to be modified, click the Reboot button to apply all changes. If there are any other settings need to be changed, continuously to finish and apply all changes and then click Reboot button to restart and take effect for all settings.
---	---

Network | WAPI Certificate Upload

WLAN Authentication and Privacy Infrastructure (WAPI) is a Chinese National Standard for Wireless LANs (GB 15629.11-2003), which was initiated to resolve the existing security loopholes (WEP) in WLAN international standard (ISO/IEC 8802-11). WAPI works by having a central Authentication Service Unit (ASU) which is known to both the wireless user and the access point and which acts as a central authority verifying both. The WAPI standard (draft JTC1/SC6/N14619) allows selection of the symmetric encryption algorithm, either AES or SMS4, which has been declassified in January 2006 and passed evaluation by independent experts.

WAPI Certificate Upload	
Description	Action
X509	
ASU Cert	<input type="text"/> <input type="button" value="Browse..."/>
AP Cert	<input type="text"/> <input type="button" value="Browse..."/>
<input type="button" value="Upload"/> <input type="button" value="Cancel"/>	

Figure 44 – WAPI certification upload

ASU Cert – uploading the ASU certification

AP Cert – uploading the AP certification

Network | Tr069 Settings

TR-069 is the Broadband Forum technical specification entitled CPE WAN Management Protocol(CWMP). It defines an application layer protocol for remote management of end-user devices. As a bidirectional SOAP/HTTP-based protocol, it provides the communication between customer-premises equipment(CPE) and Auto Configuration Servers(ACS server). It includes both a safe auto configuration and the control of other CPE management functions within an integrated framework. The protocol addressed the growing number of different internet access devices such as modems,routers,gateways,set-top-boxes,and VOIP-phones for the end users. The TR-069 standard was developed for automatic configuration of these devices with Auto Configuration Servers(ACS).

configure the remote management through TR069 ACS server(eg:BROWAN DMS server)

TR069 Settings	
Name	Status
Status	Disabled
<input type="button" value="Edit"/>	

Figure 45 – TR-069 settings

Click Edit button and the similar page will be appeared.

TR069 Settings	
Name	Status
Status	Enabled
ACS URL	http://192.168.1.1:9090/dms/tr069
ACS UserName	tr069
ACS UserPassword	tr069passwd
Enable Periodic Inform	Enabled
Periodic Inform Interval	3600
Connection Request UserName	server
Connection Request Password	serverpasswd
<input type="button" value="Save"/> <input type="button" value="Cancel"/>	

Figure 46 – edit TR-069 settings

Status – enable or disable TR-069 setting.[enable/disable]

ACS URL – enter the ACS server URL.

ACS UserName – the user name for AP register to ACS server.

ACS UserPassword – the password for AP register to ACS server.

Enable Periodic Inform – when AP registered to the ACS server, it will automatically send inform message such as S/N,OUI,manufacturer and product name to the ACS server through TR-069 protocol in a periodic time.

Periodic Inform Interval – the inform interval.[in seconds, the value is 720~4294967295]

Connection Request UserName – when the ACS pulling a task to AP/CPE such as firmware upgrade/downgrade, AP need the user name to verify the task sending from ACS server.

Connection Request Password –when the ACS pulling a task to AP/CPE such as firmware upgrade/downgrade, AP need the password to verify the task sending from ACS server.

	Contact the ACS server administrator to get the user name and password for Connection Request UserName and Connection Request Password otherwise the AP will not accept the task pulling by ACS server.
---	---

After enter all field click **save** and **apply changes** button to take effect.

TR069 Settings	
Name	Status
Status	Enabled
ACS URL	http://192.168.1.1:9090/dms/tr069
ACS UserName	tr069
ACS Password	tr069passwd
Enable Periodic Inform	Enable
Periodic Inform Interval	3600
Connection Request UserName	server
Connection Request Password	serverpasswd
<input type="button" value="Edit"/>	
<input type="button" value="Apply Changes"/> <input type="button" value="Discard Changes"/>	

Figure 47 – save TR-069 settings

Reboot – click the button to restart the server and apply the changes.

TR069 Settings	
Name	Status
Status	Enabled
ACS URL	http://192.168.1.1:9090/dms/tr069
ACS UserName	tr069
ACS Password	tr069passwd
Enable Periodic Inform	Enable
Periodic Inform Interval	3600
Connection Request UserName	server
Connection Request Password	serverpasswd

[Edit](#)

[Reboot](#)

System needs to be restarted to make the new configurations take effect.



If there is no other settings needed to be modified, click the **Reboot** button to apply all changes. If there are any other settings need to be changed, continuously to finish and apply all changes and then click **Reboot** button to restart and take effect for all settings.

Wireless

Wireless | Basic

Use the **Wireless | Basic** menu to configure wireless settings such as regulatory domain, channel, band, and power, layer 2 isolation. Click the edit button on the setting you need to change:

Basic Wireless Setting	
Radio :	wlan1
Name	Value
Mode	AP
Domain	FCC
Static Channel	6 => Current Frequency=2.437 GHz (Channel 6)
Band	2.4GHz(11n HT20/40plus)
TxPower	10dBm
RTS Threshold	2347 bytes
Fragment Threshold	2347 bytes
Beacon Interval	100 ms
DCA	Disable
Preamble	auto
Slot Time	auto
Action	Edit

Figure 48 – Basic Wireless Settings with static channel selection

Basic Wireless Setting	
Radio :	wlan1
Name	Value
Mode	AP
Domain	FCC
Auto Channel	auto => Current Frequency=2.437 GHz (Channel 6)
Band	2.4GHz(11n HT20)
TxPower	10dBm
RTS Threshold	2347 bytes
Fragment Threshold	2347 bytes
Beacon Interval	100 ms
DCA	Enable
DCA Threshold	10 mins
DCA optional channel	1,6,11 channel
Preamble	auto
Slot Time	auto
ActionAction	Edit

Figure 49 – Basic Wireless Settings with auto channel selection(DCA)

Radio – specify which wireless interface of BW1254.[wlan1(2.4G)/wlan2(5G)]

Mode – show the radio operation mode. (AP mode or Bridge mode)

Domain – show the regulatory domain

Static Channel / Auto Channel – show the channel that the access point will use to transmit and receive information

	<p>If DCA (Dynamic Channel Allocation) is enabled, this will show Auto Channel and its channel number is chosen in auto channel selection.</p> <p>If use static channel selection, this will show Static Channel and its channel number.</p>
---	--

	<p>DCA (Dynamic Channel Allocation) is useful feature to help choose the best channel automatically and reduce interference among many Access Points.</p>
---	---

Band – show the working bands on which the radio is working.

wlan1:four bands listed: 2.4GHz(11g only) , 2.4GHz(11n HT20) , 2.4GHz(11n HT20/40plus), 2.4GHz(11n HT20/40minus)

wlan2: four bands listed:5GHz(11a), 5GHz(11n HT20) , 5GHz(11n HT20/40plus), 5GHz(11n HT20/40minus) .

	<p>By default, the HT20/40 is recommended.</p>
--	--

Tx Power – show the BW1254 transmission output power (without antenna gain) in dBm.

RTS Threshold –the AP sends Request to Send(RTS) frames to a particular receiving station and negotiates the sending of a data frame. After receiving an RTS, the wireless station responds with a Clear to Send(CTS) frame to acknowledge the right to begin transmission. The default value is 2347.[recommend].

Fragment Threshold –It specifies the maximum size for a packet before data is fragmented into multiple packets. If you experience a high packet error rate, you may slightly increase the fragmentation threshold. Setting the fragmentation threshold too low may result in poor network performance. Only minor modifications of this value are recommended. The default value is 2347.[recommend]

Beacon Interval –the Beacon Interval value indicates the frequency interval of the beacon. A beacon is a packet broadcast by the AP to synchronize the wireless network.

DCA – Enable or Disable DCA service. DCA can help to choose the best working channel automatically. And static channel selection will be forbidden if DCA is enabled.

DCA(Dynamic Channel Allocation) solution automatically select the optimal operational frequency channel when power up and periodically monitors the environment and adjusts for the best operational frequency channel.

DCA threshold – specify the value (in minutes) of DCA threshold. This threshold is been used to judge if there is no wireless users connected during this time. And if yes, BW1254 will monitor the environment and adjust channel for the best operational one.

	<p>If wireless network environment is stable which means auto channel selection needn't do frequently, set a big value for DCA threshold to gain a stable wireless users' connection.</p> <p>If wireless network environment changes continually, frequent auto channel selection is needed. So set a relative small value for DCA threshold to let channel change based on wireless environment.</p>
---	---

	Wireless users' will be kicked off when DCA is processing (new operational frequency channel takes effect).
---	---

DCA optional channel – show the channels only in which auto channel selection (DCA) will be processed to reduce interference.

	Only when DCA is enabled, DCA threshold and DCA optional channel will be shown.
---	---

Preamble – if your wireless device supports the short preamble and you are having trouble getting it to communicate with other 802.11b devices, make sure that it is set to use the long preamble.

Auto: using long preamble when there are clients not supporting short preamble connected , otherwise using short preamble. The default is Auto.[recommend]

Short: always using short preamble.

Long: always using long preamble.

Slot Time – show the slot time policy when working in 2.4GHz band.

Auto: using long slot time when there are clients not supporting short slot time connection, otherwise using short slot time. The default is Auto.[recommend]

Short: always using short slot time.

Long: always using long slot time.

	To Maximize the compatibility with some 11b clients, set both Preamble and Slot Time to long.
--	---

Edit – edit the wireless basic settings

To change basic wireless setting properties click the **Edit** button in the **Action** column. The **status** can be changed now:

Basic Wireless Setting	
Name	Value
Radio Name	wlan1
Mode	AP
Domain	FCC
Channel	1
Band	2.4GHz(11ng HT20)
TxPower	14 dBm
RTS Threshold	2347 bytes [0..2347]
Fragment Threshold	2347 bytes [0..2347]
Beacon Interval	100 ms [1..65536]
DCA	<input type="checkbox"/> Enable
DCA Threshold	10 mins
DCA optional channel	<input checked="" type="checkbox"/> 1 <input checked="" type="checkbox"/> 2 <input checked="" type="checkbox"/> 3 <input checked="" type="checkbox"/> 4 <input checked="" type="checkbox"/> 5 <input checked="" type="checkbox"/> 6 <input checked="" type="checkbox"/> 7 <input checked="" type="checkbox"/> 8 <input checked="" type="checkbox"/> 9 <input checked="" type="checkbox"/> 10 <input checked="" type="checkbox"/> 11 <input checked="" type="checkbox"/> all
Preamble	auto
Slot Time	auto
<input type="button" value="Save"/> <input type="button" value="Cancel"/>	

Figure 50 – Edit Basic Wireless Settings with static channel selection

Basic Wireless Setting	
Name	Value
Radio Name	wlan1
Mode	AP
Domain	FCC
Channel	1
Band	2.4GHz(11ng HT20)
TxPower	14 dBm
RTS Threshold	2347 bytes [0..2347]
Fragment Threshold	2347 bytes [0..2347]
Beacon Interval	100 ms [1..65536]
DCA	<input checked="" type="checkbox"/> Enable
DCA Threshold	10 mins
DCA optional channel	<input checked="" type="checkbox"/> 1 <input checked="" type="checkbox"/> 2 <input checked="" type="checkbox"/> 3 <input checked="" type="checkbox"/> 4 <input checked="" type="checkbox"/> 5 <input checked="" type="checkbox"/> 6 <input checked="" type="checkbox"/> 7 <input checked="" type="checkbox"/> 8 <input checked="" type="checkbox"/> 9 <input checked="" type="checkbox"/> 10 <input checked="" type="checkbox"/> 11 <input checked="" type="checkbox"/> all
Preamble	auto
Slot Time	auto
<input type="button" value="Save"/> <input type="button" value="Cancel"/>	

Figure 51 – Edit Basic Wireless Settings with DCA enabled

Radio Name – specify wireless interface of BW1254 is shown

Mode – configure the radio operation mode. [AP mode or Dynamic Bridge mode]. There will be different configuration for the two mode within **Wireless | Advanced** menu. Please refer to corresponding chapter.

Selecting the AP Mode:

Domain – select the regulatory domain.

Channel – select the channel that the access point will use to transmit and receive information. If one channel is defined, it acts as default channel. Channels list will vary depending on selected regulatory domain and selected band. If you wish to operate more than one access point in overlapping coverage areas, we recommend at least four channels interval between the chosen channels. For example, for three Access Points in close proximity choose channels 1, 6 and 11 for 11b/g or channels 36, 40 and 64 for 11a.

Band – show the working bands on which the radio is working.

wlan1: four bands listed: 2.4GHz(11g only) , 2.4GHz(11n HT20) , 2.4GHz(11n HT20/40plus), 2.4GHz(11n HT20/40minus)

wlan2: four bands listed: 5GHz(11a), 5GHz(11n HT20) , 5GHz(11n HT20/40plus), 5GHz(11n HT20/40minus) .

TxPower – the BW1254 transmission output power in dBm.

	The value of the TxPower varies according to channel and regulatory domain.
---	---

RTS Threshold – the AP sends Request to Send(RTS) frames to a particular receiving station and negotiates the sending of a data frame. After receiving an RTS, the wireless station responds with a Clear to Send(CTS) frame to acknowledge the right to begin transmission. The default value is 2347.[recommend]

Fragment Threshold – It specifies the maximum size for a packet before data is fragmented into multiple packets. If you experience a high packet error rate, you may slightly increase the fragmentation threshold. Setting the fragmentation threshold too low may result in poor network performance. Only minor modifications of this value are recommended. The default value is 2347.[recommend]

Beacon Interval – the Beacon Interval value indicates the frequency interval of the beacon. A beacon is a packet broadcast by the AP to synchronize the wireless network.

DCA – Enable or Disable DCA service. DCA can help to choose the best working channel automatically. And static channel selection will be forbidden if DCA is enabled.

DCA(Dynamic Channel Allocation) solution automatically select the optimal operational frequency channel when power up and periodically monitors the environment and adjusts for the best operational frequency channel.

DCA threshold – specify the value (in minutes) of DCA threshold. This threshold is been used to judge if there is no wireless users connected during this time. And if yes, BW1254 will monitor the environment and adjust channel for the best operational one.

	<p>If wireless network environment is stable which means auto channel selection needn't do frequently, set a big value for DCA threshold to gain a stable wireless users' connection.</p> <p>If wireless network environment changes continually, frequent auto channel selection is needed. So set a relative small value for DCA threshold to let channel change based on wireless environment.</p>
---	---

	<p>Wireless users' will be kicked off when DCA is processing (new operational frequency channel takes effect).</p>
--	--

DCA optional channel – specify the channels only in which auto channel selection (DCA) will choose for reducing interference reference.

	<p>Only when DCA is enabled, DCA threshold and DCA optional channel will be shown.</p>
---	--

Preamble – if your wireless device supports the short preamble and you are having trouble getting it to communicate with other 802.11b devices, make sure that it is set to use the long preamble.

Auto: using long preamble when there are clients not supporting short preamble connected , otherwise using short preamble. The default is Auto.[recommend]

Short: always using short preamble.

Long: always using long preamble.

Slot Time – specify the slot time policy when working in 2.4GHz band.

Auto: using long slot time when there are clients not supporting short slot time connected in, otherwise using short slot time. The default is Auto.[recommend]

Short: always using short slot time.

Long: always using long slot time.

	<p>To Maximize the compatibility with some 11b clients, set both Preamble and Slot Time to long.</p>
---	--

Configure the DynamicBridge Mode:

Basic Wireless Setting	
Name	Value
Radio Name	wlan1
Mode	DynamicBridge
Domain	FCC
Channel	6 Current Frequency=2.437 GHz (Channel 6)
Band	2.4GHz(11n HT20)
TxPower	10 dBm
RTS Threshold	2347 bytes [0..2347]
Fragment Threshold	2347 bytes [0..2347]
Beacon Interval	100 ms [1..65536]
Preamble	auto
Slot Time	auto
<input type="button" value="Save"/> <input type="button" value="Cancel"/>	

Figure 52 – Edit Basic Wireless Settings with DynamicBridge mode

All the parameters same with AP mode. For more detail with DynamicBridge setting please refer to **Wireless | Advanced** page in DynamicBridge mode.

Change status or leave in the default state if no editing is necessary and click the **Save** button.

Basic Wireless Setting	
Name	Value
Radio :	wlan1
Mode	DynamicBridge
Domain	FCC
Channel	6 => Current Frequency=2.437 GHz (Channel 6)
Band	2.4GHz(11n HT20)
TxPower :	10dBm
RTS Threshold	2347 bytes
Fragment Threshold	2347 bytes
Beacon Interval	100 ms
DCA	Disable
Preamble	auto
Slot Time	auto
ActionAction	<input type="button" value="Edit"/>
<input type="button" value="Apply Changes"/> <input type="button" value="Discard Changes"/>	

Figure 53 – Apply or Discard dynamicbridge setting

For such change of settings, the BW1254 needs to be restarted to apply all settings changes when clicking **Apply Changes**. Request for reboot server appears:

Basic Wireless Setting	
Radio :	wlan1
Name	Value
Mode	DynamicBridge
Domain	FCC
Channel	6 => Current Frequency=2.437 GHz (Channel 6)
Band	2.4GHz(11n HT20)
TxPower	10dBm
RTS Threshold	2347 bytes
Fragment Threshold	2347 bytes
Beacon Interval	100 ms
DCA	Disable
Preamble	auto
Slot Time	auto
ActionAction	<input type="button" value="Edit"/>

System needs to be restarted to make the new configurations take effect.

Figure 54 – Reboot Server

Reboot – click the button to restart the server and apply the changes.

	If there is no other settings needed to be modified, click the Reboot button to apply all changes. If there are any other settings need to be changed, continuously to finish and apply all changes and then click Reboot button to restart and take effect for all settings.
---	---

Wireless | Advanced

BW1254 supports **Multiple BSSID (MBSSID)** function. You can configure up to 16 BSSIDs on BW1254 and assign different configuration settings to each BSSID. For wireless users, they can think BW1254 as single AP with multi-service supporting, including different security policy, different VLAN ID, different authentication etc. All the BSSIDs are active at the same time that means client devices can associate to the access point for specific service. Use the **Wireless | Advanced** menu to configure properties related to Multiple BSSID, including configure SSID, Hidden SSID, VLAN, and Security for each SSID.

	You can define different MBSSID if you configure AP mode in Wireless Basic menu.
	Each BSSID can have its own SSID. In this case, Multiple BSSID is the same with Multiple ESSID. Wireless users can think BW1254 as multiple virtual APs, each supporting different service, and connects one SSID for the special services.

There are different setting within **wireless | advanced** menu based on **AP mode** or **DynamicBridge mode** configured in **Wireless | Basic** menu.

AP Mode

If you configure AP mode, the page will be shown as below in **Wireless | Advanced** menu.

Advance Wireless Setting					
Radio: wlan1		AP Mode			
Interface	SSID	Hidden	Security	Current Connect #	Action
wlan1_0	BW1254-11ng-ggynn	Disabled	Disabled	1	Detail Edit Delete
wlan1_1	BW1254-11ng-gggy	Disabled	WPA2-PSK	0	Detail Edit Delete
					New
Refresh					

Figure 55 – Advanced Wireless Setting (AP Mode)

Radio – specify wireless interface to be configured.[wlan1(2.4G/wlan2(5G)]

Mode – show the current operation mode of this radio (AP or Bridge mode)

Interface – display the interface which corresponding to the SSID. Each Interface maps to a BSSID

SSID – SSID name for wireless client searching and associating.

Hidden – show the status of Hidden SSID feature[disable/enable]

Security – show which security policy is used for this **MBSSID** entry

Current Connect # – show the number of current wireless clients associate to this MBSSID

New – create a new **MBSSID** entry

Detail – show the detail information of this **MBSSID** entry

Edit – edit the selected **MBSSID** entry you want to configure

Delete – delete the selected **MBSSID** entry. When in AP mode, you can not delete the last entry

Refresh – rescan the WEB page to get newer information

Clicking **New** or **Edit** button to configure the SSID parameters. Describe as below:

Advance Wireless Setting			
Radio	wlan1		
Interface	wlan1_0		
Mode	AP		
SSID	BW1254-11ng-gggy (Printable ASCII Characters)		
	<input type="checkbox"/> Need Hidden SSID		
	<input checked="" type="checkbox"/> SSID status		
	<input type="checkbox"/> Disable 11b		
	<input type="checkbox"/> Only 11n		
	<input type="checkbox"/> Disassociation low MCS		
Max Station Number	<input type="checkbox"/> Enable	<input type="text" value=""/>	(1~127)
Layer 2 Isolation	<input type="checkbox"/> Enable Intra-BSS Layer 2 Isolation		
	(Inter-BSS Layer 2 Isolation can be configed in Wireless -> Layer 2 Isolation page.)		
Bandwidth			
	<input type="checkbox"/> Enable bandwidth		
		Download bandwidth	<input type="text" value=""/> (Mbps)
		Upload bandwidth	<input type="text" value=""/> (Mbps)

Figure 56 – BSSID Setting -1

Radio – show the wireless interface is being configured.

Interface – show the current sub-interface.

Mode – show the operation mode of current radio.

SSID – a unique ID for your wireless network. It is case sensitive and must not exceed 32 characters. The SSID is important for clients when connecting to the access point.

Need Hidden SSID – when enabled, the SSID of this Interface is invisible in the networks list while scanning the available networks for wireless client (SSID is not broadcasted with its Beacons). When disabled, the AP’s SSID is visible in the available network list [enabled/disabled]. By default the Hidden SSID is disabled

SSID status – activated or deactivated the SSID. The default is activated SSID[check box].

Disable 11b – enable/disable 11b client connection. [check box] to enable the function.



Only 11n – only 802.11n client can connected to the SSID.

Disassociation low MCS – low MCS client won’t associate to the AP. [check box] to enable it.

Max Station Number – define maximum number of associated wireless client to this SSID. By default the number is maximum 127 client can be associated to the AP without check box. Or check box to enable limited client.[1~127]

Layer 2 Isolation – Specify the layer 2 isolation policy.

Enable Intra-BSS Layer 2 Isolation – when enabled, the clients that connect in this same BSS can’t visit each other. By default the intra-BSS layer 2 isolation is disabled.

	Intra-BSS layer2 isolation – which enable or disable client isolation under same SSID. Inter-BSS layer2 isolation – which enable or disable client isolation between different SSID.
	Please go to Wireless Layer 2 Isolation(Inter-BSS) menu to configure inter-BSS layer 2 Isolation. Full layer 2 isolation need to set both intra-BSS and inter-BSS layer 2 isolation in the AP mode.

Bandwidth – enable/disable upstream/downstream bandwidth control per SSID.

Download bandwidth – specified the maximum downstream in Mbps controlled by the SSID.
Upload bandwidth – specify the maximum upstream in Mbps controlled by the SSID.

VLAN			
	<input type="checkbox"/> Enable VLAN		
		VLAN ID	<input type="text"/> (1~4094)
		802.1p Tag	<input type="text" value="Best Effort(0)"/> (Class of Service)
Interface Priority			
	<input type="text" value="Best Effort(0)"/> (Class of Service)		
WMM	<input checked="" type="checkbox"/> Enable WMM		
ESS in Tunnel	<input type="radio"/> Enabled		
		Remote Server IP	<input type="text"/>
	<input checked="" type="radio"/> Disabled		

Figure 57 – Multiple BSSID Setting -2

VLAN – specify VLAN policy

Enable VLAN – when enabled, the outgoing packets from this SSID device will be tagged with VLAN ID and 802.1p tag.

VLAN ID – configure VLAN ID for each Multiple SSID devices. Valid numbers are from 1 to 4094

802.1p Tag – configure 802.1p Tag for remote APC’s or Router’s QoS uses. Eight levels selective, Background(1), Spare(2), Best Effort(0), Excellent Effort(3), Controlled Load(4), Interactive Video(5), Interactive Voice(6), Network Contro(7)

	VLAN ID and 802.1p tag must cooperate with remote Router or APC.
---	--

Interface priority – specify the traffic priority for this SSID interface, which is implemented according to 802.11e EDCA and makes sure the wireless downlink QoS. This priority is based on SSID, which means different BSSID can have different traffic priority and the traffic of the same SSID has the same priority

	This traffic priority only makes sure the priority of downlink (from AP to wireless client). 8 levels priorities are supplied. 1, 2, 0, 3, 4, 5, 6, 7 is from lowest priority to highest priority. And if no special QoS is needed, leave priority to default (0). 0 means Best Effort priority.
---	---

WMM –BW1254 support WMM wireless clients and implement WMM QoS with the WMM clients.
 [enable]

ESS in Tunnel – Settings for ESS in tunnel. When enabled, BW1254 setup tunnel with remote AC for passing through layer3 network.

Remote Server IP – IP address of remote AC product that setup tunnel with BW1254

Security			
<input type="radio"/> WEP(Wired Equivalent Privacy)			
	WEP KeyIndex	<input type="text" value="1"/>	
<input type="radio"/> 802.1x			
	RADIUS Server Profile	<input type="text" value="DEFAULT"/>	
	Dynamic WEP Encryption	<input type="radio"/> Disabled <input type="radio"/> 64 bits <input type="radio"/> 128 bits	
		<input type="checkbox"/> Pass Through	
<input type="radio"/> WPA			
	RADIUS Server Profile	<input type="text" value="DEFAULT"/>	
	Algorithm	<input type="text" value="TKIP"/>	
	Group Key Rekey Interval	<input type="text"/> Minutes	
<input type="radio"/> WPA2			
	RADIUS Server Profile	<input type="text" value="DEFAULT"/>	
	Algorithm	<input type="text" value="TKIP"/>	
	Group Key Rekey Interval	<input type="text"/> Minutes	
<input type="radio"/> WPA2 MIXED			
	RADIUS Server Profile	<input type="text" value="DEFAULT"/>	
	Algorithm	TKIP/AES	
	Group Key Rekey Interval	<input type="text"/> Minutes	

Figure 58 – Multiple BSSID Setting – 3

Security – specify the security policy

WEP – Wired Equivalent Privacy(WEP) is a security algorithm for IEEE 802.11 wireless networks.

WEP Key Index – select the default key Index to make it the Default key and encrypt the data before being transmitted. All stations, including this MSSID Entry, always transmit data encrypted using this Default Key. The key number (1, 2, 3, 4) is also transmitted. The receiving station will use the key number to determine which key to use for decryption. If the key value does not match with the transmitting station, the decryption will fail. The key value is set in **Wireless | WEP** web page

802.1x – when selected, the MSSID entry will be configured as an 802.1x authenticator. It supports multiple authentication types based on EAP (Extensible Authentication Protocol) like EAP-TLS, EAP-TTLS, EAP-PEAP, EAP-SIM. The privacy will be configured as dynamic WEP

RADIUS Server Profile – select your RADIUS server profile

	Please go to Network RADIUS Server menu to configure your RADIUS server profile or add a new profile, and please refer to Network RADIUS Server for its configuration.
---	--

Dynamic WEP Encryption – select whether using the dynamic 64-bits encryption, 128-bits encryption or without encryption

Pass Through – when enabled, client can access network whether it passed 802.1x authentication or not

	Only when 802.1x enabled and dynamic key disabled this option can be enabled.
---	---

WPA – Wi-Fi Protected Access, When selected, the encrypt method will be WPA with RADIUS Sever

WPA2 – when selected, the security policy will be WPA2 with RADIUS server. In this mode, WPA client is not permitted to connect

WPA2 MIXED – when selected, WPA2 client and WPA client are all permitted to connect

RADIUS Server Profile – select your RADIUS server profile

	Please go to Network RADIUS Server menu to configure your RADIUS server profile or add a new profile, and please refer to Network RADIUS Server for its configuration.
---	--

Algorithm – choose WPA algorithm (TKIP, AES)

Group Key Rekey Interval – specify amount of minutes and WPA automatically will generate a new Group Key

<input type="radio"/> WPA-PSK		
	Use Pre-Shared Key	<input type="text"/>
	Algorithm	TKIP 
	Group Key Rekey Interval	<input type="text"/> Minutes
<input type="radio"/> WPA2-PSK		
	Use Pre-Shared Key	<input type="text"/>
	Algorithm	TKIP 
	Group Key Rekey Interval	<input type="text"/> Minutes
<input type="radio"/> WPA2-PSK MIXED		
	Use Pre-Shared Key	<input type="text"/>
	Algorithm	TKIP/AES
	Group Key Rekey Interval	<input type="text"/> Minutes
<input type="radio"/> MAC Auth		
	RADIUS Server Profile	DEFAULT 

Figure 59 – Multiple BSSID Setting – 4

WPA-PSK – when selected, the encrypt method will be WPA without RADIUS server

WPA2-PSK – when selected, the security policy will be WPA2 PSK without RADIUS server. In this mode, only WPA2 PSK client can connect with AP and WPA PSK client is not permitted to connect

WPA2-PSK MIXED – when selected, WPA2 PSK and WPA PSK clients are all permitted to connect with AP

Use Pre-Shared Key –specify more than 8 characters and less than 64 characters for WPA with pre-shared key encryption

Algorithm – choose WPA algorithm (TKIP, AES)

Group Key Rekey Interval –specify amount of minutes and WPA automatically will generate a new Group Key

MAC Auth – when selected, the MAC address of wireless client will be passed to RADIUS server for PAP authentication when it connects with BW1254. The MAC address of wireless client acts as username and password

RADIUS Server Profile – select the default radius server name

<input type="radio"/> WAPI	AAA Server Profile:	DEFAULT
WAPI certificate has not been Uploaded. Click here to upload certificate.		
<input type="radio"/> WAPI-PSK	Encode:	HEX
	Use Pre-Shared Key:	<input type="text"/>
<input type="radio"/> Disabled		
<input type="button" value="Save"/> <input type="button" value="Cancel"/>		

Figure 60 – Multiple BSSID Setting – 5

WAPI – WLAN Authentication and Privacy Infrastructure (WAPI) is a Chinese National Standard for wireless LAN(GB15629.11-2003).(Only for China)

It needs to upload WAPI certificate.

AAA Server Profile – select your RADIUS server profile

WAPI-PSK –the encrypt method will be WAPI without RADIUS server

Encode – Pre-shared key encode.[HEX/ASCII]

Use Pre-Shared key – specify more than 8 characters and less than 64 characters for WPA with pre-shared key encryption

Disabled – when selected, you don't select any security policy

Change status or leave in the default state if no editing is necessary and click the **Save** button.

Advance Wireless Setting	
Radio	wlan1
Interface	wlan1_0
Mode	AP
SSID	SSID
Hidden SSID	Disabled
Intra-BSS Layer 2 Isolation	Disabled
Use VLAN	Disabled
Interface Priority	Best Effort(0) (Class of Service)
WMM	Enabled
ESS in Tunnel	Disabled
Security	Disabled
Current Connected Number	0
<input type="button" value="Refresh"/> <input type="button" value="Return"/>	
<input type="button" value="Apply Changes"/> <input type="button" value="Discard Changes"/>	

Figure 61 –Apply or Discard the advanced Settings in AP mode

For each change of settings, the BW1254 needs to be restarted to apply all settings changes when clicking **Apply Changes**. Request for reboot server appears:

Advance Wireless Setting	
Radio	wlan1
Interface	wlan1_0
Mode	AP
SSID	SSID
Hidden SSID	Disabled
Intra-BSS Layer 2 Isolation	Disabled
Use VLAN	Disabled
Interface Priority	Best Effort(0) (Class of Service)
WMM	Enabled
ESS in Tunnel	Disabled
Security	Disabled
Current Connected Number	0

System needs to be restarted to make the new configurations take effect.

Figure 62 – Reboot information

Reboot – click the button to restart the server and apply the changes.

If there is no other settings needed to be modified, click the **Reboot** button to apply all changes. If there are any other settings need to be changed, continuously to finish and apply all changes and then click **Reboot** button to restart and take effect for all settings.

DynamicBridge Mode

DynamicBridge is smart, high efficiency, high performance, easy deployment and easy configuration for point to multi-point bridge link. It enables BW1254 to automatically seek and associate nearby root AP and dynamically self-configure for wireless bridge connection. Whenever a bridge link is broken, the network will auto re-configure route to minimize the lost of WLAN operation. It also minimized the technician intervention and reduce cost of going on-site to re-establish transmission paths.

Advance Wireless Setting			
Dynamic Bridge Mode			
Radio:	wlan1		
Normal mode : using frequency base on root AP.			
NodeType	NetID	Security	Action
Root	default	Disabled	<input type="button" value="Edit"/>

Figure 63 – Advanced Wireless Setting (Bridge Mode)

Radio – specify the wireless interface

NodeType – show the node type (root or normal)

NetID – Net ID for the association between root and normal(client) bridge link. It must be the same between root and normal(client) association.

Security – specify which security policy is used

Edit – edit the selected **Bridge link** entry you want to configure

Clicking **Edit** to configure the bridge parameters.

NodeType	NetID	Security	Action
Root	default_1	<input type="radio"/> WPAPSK-AES Pre-Shared Key: <input type="text"/> <input checked="" type="radio"/> Disabled	<input type="button" value="Save"/> <input type="button" value="Cancel"/>

Normal mode : using frequency base on root AP.

Figure 64 – Bridge Link Setting

NodeType – determine the AP as Root or client rule. As a root AP, the nearby bridge client will automatically associate to the root AP based on the signal quality. In case a bridge link is broken, the client AP will automatically seek the nearby root AP based on the best signal quality and same NetID to re-build a bridge link. For the client AP the NetID must same with root AP to distinguish which root AP is in the link table. And the frequency channel is determined by the root AP despite the client AP configured.

NetID – NetID is a very important element for the dynamicbridge link. The link between root and client AP will based on the same NetID to make the bridge link.

Security – specify the security policy of the bridge link. [WPA-PSK (AES)/disable]

WPAPSK-AES –specify more than 8 characters and less than 64 characters for WPA with pre-shared key encryption

Disable – no data encryption for the bridge link.

Click **Save** button to save the change of settings or **Cancel** button to discard the change

NodeType	NetID	Security	Action
Root	default	WPAPSK-AES	<input type="button" value="Edit"/>

Figure 65 –Apply or Discard the advanced Settings in Bridge mode

For each change of settings, the BW1254 needs to be restarted to apply all settings changes when clicking **Apply Changes**. Request for reboot server appears:

System needs to be restarted to make the new configurations take effect.

Figure 66 – Reboot information

Reboot – click the button to restart the server and apply the changes.

	<p>If there is no other setting needed to be modified, click the Reboot button for applying all modifications.</p> <p>And if there are still other setting modifications needed, go ahead to finish all changes and then click Reboot button to restart and apply all settings together.</p>
---	--

Wireless | WEP

Use the **Wireless | WEP** menu to configure static WEP settings.

	<p>This menu only set static WEP key value related with 4 key indexes. Enable or Disable static WEP is in the Wireless Advance menu.</p>
---	---

WEP Configuration

Radio: wlan1

Index	Key	Action
Key 1	*****	<input type="button" value="Edit"/>
Key 2	*****	<input type="button" value="Edit"/>
Key 3	*****	<input type="button" value="Edit"/>
Key 4	*****	<input type="button" value="Edit"/>

The network password needs to be 64bits or 128bits depending on your network configuration. This can be entered as 5 or 13 ascii characters or 10 or 26 hexadecimal characters.

Figure 67 – WEP Settings

Radio –show the wireless interface.

Click **Edit** to edit the existing **wepkey1** to **wepkey4**.

	<p>By default, four WEP keys are all set to “aaaaa” (ascii characters) or “6161616161” (hexadecimal characters). They can be modified according to requirement.</p>
---	---

WEP Configuration

Radio: wlan1

Index	Key	Action
Key 1	<input type="text"/>	<input type="button" value="Save"/> <input type="button" value="Cancel"/>
Key 2	*****	<input type="button" value="Edit"/>
Key 3	*****	<input type="button" value="Edit"/>
Key 4	*****	<input type="button" value="Edit"/>

The network password needs to be 64bits or 128bits depending on your network configuration. This can be entered as 5 or 13 ascii characters or 10 or 26 hexadecimal characters.

Figure 68 – Edit WEP Key

Change status or leave in the default state if no editing is necessary and click the **Save** button.

WEP Configuration		
Radio	wlan1 <input type="button" value="v"/>	
Index	Key	Action
Key 1	*****	<input type="button" value="Edit"/>
Key 2	*****	<input type="button" value="Edit"/>
Key 3	*****	<input type="button" value="Edit"/>
Key 4	*****	<input type="button" value="Edit"/>
The network password needs to be 64bits or 128bits depending on your network configuration. This can be entered as 5 or 13 ascii characters or 10 or 26 hexadecimal characters.		

Figure 69 –Apply or Discard WEP Configuration

For each change of settings, the BW1254 needs to be restarted to apply all settings changes when clicking **Apply Changes**. Request for reboot server appears:

WEP Configuration		
Radio	wlan1 <input type="button" value="v"/>	
Index	Key	Action
Key 1	*****	<input type="button" value="Edit"/>
Key 2	*****	<input type="button" value="Edit"/>
Key 3	*****	<input type="button" value="Edit"/>
Key 4	*****	<input type="button" value="Edit"/>
The network password needs to be 64bits or 128bits depending on your network configuration. This can be entered as 5 or 13 ascii characters or 10 or 26 hexadecimal characters.		

System needs to be restarted to make the new configurations take effect.

Figure 70 – Reboot information

Reboot – click the button to restart the server and apply the changes

	If there is no other settings needed to be modified, click the Reboot button to apply all changes. If there are any other settings need to be changed, continuously to finish and apply all changes and then click Reboot button to restart and take effect for all settings.
---	---

Wireless | MAC ACL

Use the **MAC ACL** service to control the default access to the wireless interface of the BW1254 or define special access rules for mobile clients. Configure the ACL using the **Wireless | MAC ACL** menu:

MAC ACL Configuration		
Radio	wlan1	
Policy	Allow	<input type="button" value="Edit"/>
MAC List		Action
	00:90:4B:C9:42:55	<input type="button" value="Delete"/>
<input type="button" value="Add"/>		

Figure 71 – MAC ACL Service

Radio – show the wireless interface.

	The wireless interface which is Bridge mode hasn't MAC ACL settings.
---	--

Policy – click the **edit** button to choose Allow, Deny or disable the access control service on device. By default the ACL service is disabled and all wireless clients connecting to the BW1254 are allowed (no ACL rules are applied to the wireless clients)

Select **Allow** means only the wireless clients whose MAC are listed in the **MAC List** would be permitted to access this AP. Other wireless client cannot access this AP.

Select **Deny** means only the wireless clients whose MAC are listed in the **MAC List** would be prevented from accessing. Other wireless clients can access this AP.

Select **Disabled** means no ACL service.

MAC ACL Configuration		
Radio	wlan1	
Policy	Allow	<input type="button" value="Save"/> <input type="button" value="Cancel"/>
MAC List	Allow	Action
	Deny	
	Disabled	
	00:90:4B:C9:42:55	<input type="button" value="Delete"/>
<input type="button" value="Add"/>		

Figure 72 – MAC ACL settings

You must create **MAC List** to work with **Policy** setting. The access control list is based on the network device's MAC address. In the MAC ACL Configuration table, you only need to specify the MAC address of wireless client. Click the **Add** button to create a new MAC entry:

MAC ACL Configuration		
Radio	wlan1	
Policy	Allow	<input type="button" value="Edit"/>
MAC List		Action
	00:90:4B:C9:42:55	<input type="button" value="Delete"/>
<input type="text"/>	Example: 00:90:4B:00:11:22	<input type="button" value="Save"/> <input type="button" value="Cancel"/>

Figure 73 – Add MAC entry

MAC Address – enter the physical address of the network device you need to (MAC address). The format is a list of colon separated hexadecimal numbers (for example: 00:90:4B:00:11:22)

Save – click the button to save the new MAC entry

MAC ACL Configuration		
Radio	wlan1	
Policy	Allow	<input type="button" value="Edit"/>
MAC List		Action
	00:90:4B:C9:42:55	<input type="button" value="Delete"/>
<input type="button" value="Add"/>		

Figure 74 – Apply or Discard MAC ACL Configuration Changes

Apply Changes – to save all changes made in the **interface** table at once

Discard Changes – restore all previous values

For such change of settings, the BW1254 needs to be restarted to apply all settings changes when clicking **Apply Changes**. Request for reboot server appears:

MAC ACL Configuration		
Radio	wlan1	
Policy	Allow	<input type="button" value="Edit"/>
MAC List		Action
	00:90:4B:C9:42:55	<input type="button" value="Delete"/>
<input type="button" value="Add"/>		

System needs to be restarted to make the new configurations take effect.



Figure 75 – Reboot Server

Reboot – click the button to restart the server and apply the changes

	If there is no other settings needed to be modified, click the Reboot button to apply all changes. If there are any other settings need to be changed, continuously to finish and apply all changes and then click Reboot button to restart and take effect for all settings.
---	---

Wireless | Layer 2 Isolation(Inter-BSS)

Use the **Layer 2 Isolation** service to block inter-BSS communication of all users. Users can only access the AP connected, the gateway and devices in the allow MAC List.

	Please go to Wireless Advanced page to configure intra-BSS communication of users in the same BSS. Full layer 2 isolation need to set both intra-BSS and inter-BSS layer 2 isolation.
	The Wireless layer 2 isolation setting page is only exist in AP mode as it is only for inter-BSS layer 2 isolation. There is no Wireless layer 2 isolation setting page in AP-Router mode.

Layer 2 Isolation Setting (Inter-BSS)		
Status	disable	Edit
Intra-BSS Layer 2 Isolation can be configed for each BSS in Wireless -> Advanced page.		

Figure 76 – layer 2 Isolation Service

Edit – edit the layer 2 isolation settings.

To change layer 2 isolation setting properties click the **Edit** button.

Layer 2 Isolation Setting (Inter-BSS)		
Status	<div style="border: 1px solid black; padding: 2px;"> disable ▼ enable disable </div>	Save Cancel
Intra-BSS Layer 2 Isolation can be configed for each BSS in Wireless -> Advanced page.		

Figure 77 – layer 2 Isolation Setting

Status –select status from the drop-down menu.

disable – disable the layer 2 isolation (Inter-BSS) service.

enable – enable the layer 2 isolation (Inter-BSS) service.

Only when Inter-BSS Isolation is enabled, the entry of the allowed MAC list can be added.

Layer 2 Isolation Setting (Inter-BSS)		
Status	enable ▼	Save Cancel
Allowed MAC List		
Name	Allowed MAC	Action
No entry in list		
Add		
Intra-BSS Layer 2 Isolation can be configed for each BSS in Wireless -> Advanced page.		
The MAC addresses of AP and Gateway are always automatically added to Allowed MAC List without manual configuration.		

Figure 78 –Allowed MAC List

	The MAC addresses of AP and Gateway are always automatically added to allowed MAC list without manual configuration.
---	--

Click the **Add** button to create a new MAC entry or click **Edit** button to edit the MAC entry:

Layer 2 Isolation Setting (Inter-BSS)

Allowed MAC List

Name	Allowed MAC
<input type="text" value="default"/>	<input type="text" value="00:00:00:00:00:00"/>

Intra-BSS Layer 2 Isolation can be configed for each BSS in Wireless -> Advanced page.

The MAC addresses of AP and Gateway are always automatically added to Allowed MAC List without manual configuration.

Figure 79 –Add MAC entry

Name – the new Allowed MAC name, which length range is 1 to 32.

MAC Address – enter the physical address of the network device (MAC address). The format is a list of colon separated hexadecimal numbers (for example: 00:90:4B:00:11:22)

Save – click the button to save the new Allowed MAC List entry

Cancel – discard change and restore all previous values

For such change of settings, the BW1254 needs to be restarted to apply all settings changes when clicking **Apply Changes**. Request for reboot server appears:

Layer 2 Isolation Setting (Inter-BSS)

Status	<input type="text" value="enable"/>	<input type="button" value="Save"/> <input type="button" value="Cancel"/>
--------	-------------------------------------	---

Allowed MAC List

Name	Allowed MAC	Action
PC1	00:90:4B:D5:11:22	<input type="button" value="Delete"/> <input type="button" value="Edit"/>

Intra-BSS Layer 2 Isolation can be configed for each BSS in Wireless -> Advanced page.

The MAC addresses of AP and Gateway are always automatically added to Allowed MAC List without manual configuration.

Figure 80 –Save Allowed MAC List Changes

Apply Changes – save all changes

Discard Changes –restore all previous values

Layer 2 Isolation Setting (Inter-BSS)

Status	enable	Edit
--------	--------	----------------------

Allowed MAC List

Name	Allowed MAC	Action
PC1	00:90:4B:D5:11:22	Delete Edit
Add		

Intra-BSS Layer 2 Isolation can be configed for each BSS in Wireless -> Advanced page.

The MAC addresses of AP and Gateway are always automatically added to Allowed MAC List without manual configuration.

[Reboot](#)

System needs to be restarted to make the new configurations take effect.

Figure 81 –apply changes

Reboot – click the button to restart the server and apply the changes

i

If there is no other settings needed to be modified, click the **Reboot** button to apply all changes. If there are any other settings need to be changed, continuously to finish and apply all changes and then click **Reboot** button to restart and take effect for all settings.

Wireless | Neighbor List

The neighbor list will scan neighbor access point to show the RSSI, channel...etc information in the environment.

Neighbor List					
SSID	MAC address	RSSI (dBm)	Channel	Co-Channel	Adjacent Interference
iHsinChu	00:16:16:02:1D:F1	-60	1	Y	Y
	00:16:16:02:1D:F2	-61	1	Y	Y
iTaiwan	00:16:16:02:1D:F0	-58	1	Y	Y
Scan 2.4G Scan 5G					

Figure 82 – neighbor list

Click **Scan 2.4G** or **Scan 5G** button.

SSID – the SSID of scanned access point

MAC address – the MAC address of scanned access point

RSSI(dBm) – the RSSI of scanned access point(in dBm)

Channel –the channel of scanned access point

Co-Channel – display if the neighbor access point channel same with BW1254.[“Y”,yes/“N”,no]

Adjacent Interference –display the neighbor access point channel adjacent to BW1254.[“Y”,yes or “N”,no]. It is based on the neighbor within 4 channels of BW1254. For instance, if BW1254 channel is 6 then the neighbor access point will be marked “Y” if its channel is 2,3,4,5 or 7,8,9,10.

Wireless | Priority 5G

The priority connection for dual band client. When the wlan1(2.4G) and wlan2(5G) configure same SSID, the 5G frequency will prior to 2.4G connection if the client support dual band frequency.



Once WLAN1 and WLAN2 configure same SSID, the interface and SSID will display automatically. Otherwise there will be nothing display in this page.

Priority 5G						
Interface	SSID	Reject counter	Interval second	Delay	Enable	ActionAction
wlan1_2	BW1254	7	10	15	Disabled	Edit

Figure 83 – priority 5G

Click Edit button to configure it.

Priority 5G						
Interface	SSID	Reject counter	Interval second	Delay	Enable	ActionAction
wlan1_2	BW1254	<input type="text" value="7"/> (7~20)	<input type="text" value="10"/> (4~60)	<input type="text" value="15"/> (4~20)	<input checked="" type="checkbox"/>	Save Cancel

Figure 84 – enable 5G priority

Interface – the interface of BW1254

SSID – the SSID of BW1254.[both 2.4G and 5G]

Reject counter – the counter that AP will reject 2.4G client connection

Interval second – the interval second during every reject counter

Delay – delay time of reject counter.

Enable – enable or disable the function.[check box or not]

Save/cancel – save/cancel configuration

Click apply changes or discard changes button to apply or discard the setting.

Priority 5G						
Interface	SSID	Reject counter	Interval second	Delay	Enable	ActionAction
wlan1_2	BW1254	7	10	15	Enabled	Edit

[Apply Changes](#) [Discard Changes](#)

Figure 85 – apply/discard changes

Reboot device

Priority 5G						
Interface	SSID	Reject counter	Interval second	Delay	Enable	ActionAction
wlan1_2	BW1254	7	10	15	Enabled	Edit

[Reboot](#)

System needs to be restarted to make the new configurations take effect.

Figure 86 – reboot device



If there is no other settings needed to be modified, click the **Reboot** button to apply all changes. If there are any other settings need to be changed, continuously to finish and apply all changes and then click **Reboot** button to restart and take effect for all settings.

User

User | Users

The **User | Users** menu shows the statistics of connected users. The user can be monitored and managed such as drop from the network.

Users								
Index	User	Interface	User IP	Authed	Wireless Auth	Time Length	Idle Time	Action
01.	00:0c:41:16:97:aa	wlan1_0	192.168.120.62	No	NONE	00:26:53	00:00:25	Details Kickoff
Refresh								

Figure 87 – User’s statistics

User – show the connected client’s MAC address

Interface – show which BSS the client connected to

User IP – IP address, from which the user’s connection is established [digits and dots]

Authed – indicate this client is authenticated or not

Wireless Auth – show the authentication method which user used to connect

Time Length – session duration since the user login [hh:mm:ss]

Idle Time – amount of user inactivity time [hh:mm:ss]

Action – view the statistics or kickoff the user.

Detail – click on user details to get more information about the client:

Kickoff – logout the user.

Users		
Description	Value	Action
user	00:0c:41:16:97:aa	
interface	wlan1_0	
user IP	192.168.120.62	
MAC address	00:0c:41:16:97:aa	
L2 Auth	NONE	
WISP	-	
session id	-	
time length	01:26:01	
remaining time length	-	
idle time	00:00:21	
idle timeout	-	
input bytes	183 KB	
output bytes	88 KB	
remaining input bytes	-	
remaining output bytes	-	
remaining total bytes	-	
bandwidth downstream	-	
bandwidth upstream	-	
		<input type="button" value="Back"/> <input type="button" value="Kickoff"/>
		<input type="button" value="Refresh"/>

Figure 88 – User's Details

MAC address – hardware address of the network device from which the user is connected

L2 Auth – show layer2 authentication status, including all supported EAP type of 802.1x auth and MAC auth

WISP – WISP domain name where the user belongs

Session ID – the unique user's session ID number. This can be used for troubleshooting purposes

Remaining Time Length – remaining user's session time [hh:mm:ss]. Session time for user is defined in the RADIUS Server

Idle time – specify current idle time.

Idle Timeout – specify the time of user idle timeout [hh:mm:ss]. When reach the time, the user will be logged out automatically.

Input Bytes – amount of data in bytes which the user network device has received [Bytes]

Output Bytes – amount of data in bytes, transmitted by the user network device [Bytes]

Remaining Input/Output Bytes – user session remaining input/output bytes. WISPr Operator can define the user session in bytes. Remaining bytes is received from RADIUS [Bytes/unlimited]

Remaining Total Bytes –user session remaining total bytes. WISPr Operator can define the user session in bytes. Remaining bytes is received from RADIUS [Bytes/unlimited]

Bandwidth Downstream/Upstream – user upstream and downstream bandwidth [in bps]

Back – returns to connect client’s statistics list

Kickoff –click this button to logout the user from access point.

Refresh – click the button to refresh users’ statistics

User | Station Supervision

The **Station Supervision** function is used to monitor the connected host station availability. This monitoring is performed with ping. If the specified number of ping failures is reached (**failure count**), the user is logged out from the BW1254.

Station Supervision		
Interval	Failure Count	Action
20	3	<input type="button" value="Edit"/>

Figure 89 – Station Supervision

To adjust the ping interval/failure count, click the **Edit** button.

Station Supervision		
Interval	Failure Count	Action
<input type="text" value="20"/>	<input type="text" value="3"/>	<input type="button" value="Save"/> <input type="button" value="Cancel"/>

Figure 90 – Edit Station Supervision

Interval – define interval of sending ping to host [in seconds]

Failure Count – failure count value after which the user is logged out from the system

Save – save station supervision settings

Cancel – cancel changes

Change status or leave in the default state if no editing is necessary and click the **Save** button.

Station Supervision		
Interval	Failure Count	Action
20	3	<input type="button" value="Edit"/>



Figure 91 –Apply or Discard Station Supervision Changes

Apply Changes – to save all changes made in the **interface** table at once

Discard Changes – restore all previous values

For such change of settings, the BW1254 needs to be restarted to apply all settings changes when clicking **Apply Changes**. Request for reboot server appears:

Station Supervision		
Interval	Failure Count	Action
20	3	Edit

[Reboot](#)

System needs to be restarted to make the new configurations take effect.

Figure 92 – Reboot Server

Reboot – click the button to restart the server and apply the changes

	If there is no other settings needed to be modified, click the Reboot button to apply all changes. If there are any other settings need to be changed, continuously to finish and apply all changes and then click Reboot button to restart and take effect for all settings.
---	---

Services

Services | Telnet

Use **Services | Telnet** menu to manage the telnet/SSH service of your BW1254.

Telnet		
Name	Status	Action
Telnet Service	Enabled	Edit
SSH Service	Enabled	Edit

Figure 93 – System Configuration settings

Telnet Service – Enable or disable telnet service of BW1254

SSH Service – Enable or disable SSH service of BW1254

The default of these two services are all **Enabled**. The current IETF SSH (SSHv2) is supported for security of accessing BW1254 via telnet/CLISH.

Services | SNMP

SNMP is the standard protocol that regulates network management over the Internet. To communicate with SNMP manager you must set up the same **SNMP** communities and identifiers on both ends: manager and agent.

Use the **Services | SNMP** menu to change current SNMP configuration.

General Configuration		
Name	Value	Action
Readonly community	public	Edit
Readwrite community	private	Edit
DefaultTrap community	public	Edit
HeartBeat Trap Interval	10 seconds	Edit

Trap Configuration					
Index	Host Ip	Host Port	Trap Type	Community	Action
1	192.168.120.62	162	trapsink	test	Delete

[Add](#)

Figure 94 – SNMP settings

Readonly community – community name is used in SNMP version 1 and version 2c. Read-only (public) community allows reading values, but denies any attempt to change values [1-32 all ASCII printable characters, no spaces]

Readwrite community – community name is used in SNMP version 1 and version 2c. Read-write (private) community allows to read and (where possible) change values [1-32 all ASCII printable characters, no spaces]

Default Trap community – the default SNMP community name used for traps without specified communities. The default community by most systems is "public". The community string must match the community string used by the SNMP network management system (NMS) [1-32 all ASCII printable characters, no spaces]

HeartBeat Trap Interval – defined the AP sending the trap interval to the SNMP server.[second]

Trap Configuration Table:

You can configure your SNMP agent to send **SNMP Traps** (and/or inform notifications) under the defined host (SNMP manager) and community name (optional).

Click **Add** to add a new SNMP manager or **Delete** to delete a specific SNMP manager. Clicking **Add**:

Trap Configuration						
Index	Host Ip	Host Port	Trap Type	Community	Action	
No entry in list						
	<input type="text" value="192.168.123.65"/>	<input type="text" value="162"/>	<input type="text" value="trapsink"/> <div style="border: 1px solid black; padding: 2px;"> trapsink trap2sink informsink </div>	<input type="text" value="test"/>	<input type="button" value="Save"/>	<input type="button" value="Cancel"/>

Figure 95 – Add SNMP Trap

Host IP – enter SNMP manager IP address [dots and digits]

Host Port – enter the port number the trap messages should be send through [number]

Trap Type – select trap message type [v1/v2/inform]

Community – specify the community name at a SNMP trap message. This community will be used in trap messages to authenticate the SNMP manager. If not defined, the default trap community name will be used (specified in the SNMP table) [1-32 all ASCII printable characters, no spaces]

Save – save all current settings

Cancel – restore the last settings

Services | Time

Configure the system time manually under **Services | Time Settings** menu.

Date and Time	
Date	2013/08/30
Time	15:20
<input type="button" value="Edit"/> <input type="button" value="Refresh"/>	

Figure 96 – Time Settings

Click **Edit** to change current system time.

Date and Time	
Date	<input type="text" value="2013"/> / <input type="text" value="08"/> / <input type="text" value="30"/>
Time	<input type="text" value="15"/> : <input type="text" value="20"/>
<input type="button" value="Apply"/> <input type="button" value="Cancel"/>	

Figure 97 – Edit Date and Time Settings

Date – [yy/mm/dd]

Time – [hour/minute]

Change the Date and Time or leave in the default value if no editing is necessary and click the **Apply** button. Thus the modified time will be taken effect at once. No reboot is needed.

	If NTP is enabled, the local time cannot be modified.
---	---

	Since BW1254 hasn't RTC (real-time clock), the system time will back to 1970/01/01 00:00 after reboot.
---	--

Services | NTP

NTP (Network Time Protocol) is used to synchronize the system time with the selected network NTP server. Use the **Services | NTP** menu to configure the NTP service:

NTP Server		
NTP Status disable		
Time Zone GMT-12:00		
Name	ServerIP	Action
No entry in list		
<input type="button" value="Add"/>		

Figure 98 – NTP Settings

NTP Status – specify enable or disable this NTP service

Time Zone – specify the time zone for NTP service

Delete – delete the existed NTP server



Edit – edit the settings of the existed NTP server

Add – add a new NTP server setting for synchronizing time

Clicking **Add** button to add a new NTP server:

NTP Server	
Name	ServerIP
<input type="text" value="Ntpserver"/>	<input type="text" value="207.46.103.100"/>
<input type="button" value="Save"/> <input type="button" value="Cancel"/>	

Figure 99 – Add new NTP server setting

	Two NTP servers can be configured under Services NTP menu. And only IP address is accepted for NTP server. Adding at least one NTP server before enable NTP service.
	The Name of NTP server should be unique.

Change status or leave in the default state if no editing is necessary and click the **Save** button.

NTP Server		
NTP Status disable		
Time Zone GMT-12:00		
Name	ServerIP	Action
time.nist.gov	192.43.244.18	<input type="button" value="Delete"/> <input type="button" value="Edit"/>
<input type="button" value="Add"/>		

Figure 100 – Save the NTP server Changes

Change the Time Zone for your own local time and change the NTP status to enable or disable.

NTP Server		
NTP Status	enable	
Time Zone	GMT+08:00	
Name	ServerIP	Action
time.nist.gov	192.43.244.18	Delete Edit
Save Cancel		

Apply Changes Discard Changes

Figure 101 – Edit Time Zone setting/NTP status

Click **Save** button to save new Time Zone setting.

NTP Server		
NTP Status	enable	
Time Zone	GMT+08:00	
Name	ServerIP	Action
time.nist.gov	192.43.244.18	Delete Edit
Add		

Apply Changes Discard Changes

Figure 102 – Apply or Discard Time Zone/NTP status Changes

For each change of settings, the BW1254 needs to be restarted to apply all settings changes when clicking **Apply Changes**. Request for reboot server appears:

NTP Server		
NTP Status	enable	
Time Zone	GMT+08:00	
Name	ServerIP	Action
time.nist.gov	192.43.244.18	Delete Edit
Add		

Reboot

System needs to be restarted to make the new configurations take effect.

Figure 103 – Reboot information

Reboot – click the button to restart the server and apply the changes

	If there is no other settings needed to be modified, click the Reboot button to apply all changes. If there are any other settings need to be changed, continuously to finish and apply all changes and then click Reboot button to restart and take effect for all settings.
--	---

Services | Watchdog

BW1254 supports watchdog function for the reliability. Use **Services | Watchdog** to enable/disable watchdog service.

Watchdog			
Name	Status	Check Interval	Action
Software Watchdog	Enabled	10 Seconds	Edit
Hardware Watchdog	Enabled		Edit

Figure 104 – Watchdog settings

Click Edit button to edit software watchdog settings. The UI will appear as below:

Watchdog			
Name	Status	Check Interval	Action
Software Watchdog	Enabled <input type="button" value="v"/>	10 <input type="text" value="10"/> Seconds	Save Cancel
Hardware Watchdog	Enabled		Edit

Figure 105 – edit Software Watchdog settings

Status – Enable or Disable software watchdog

Check Interval – the periodical time that software watchdog checks the whole file system of BW1254.

The hardware watchdog function will protect device even the operation system crash.

Watchdog			
Name	Status	Check Interval	Action
Software Watchdog	Enabled	10 Seconds	Edit
Hardware Watchdog	Enabled <input type="button" value="v"/>		Save Cancel

Figure 106 – edit hardware watchdog settings

Status – Enable or Disable hardware watchdog

	The default value is enabled for both Software Watchdog and Hardware Watchdog. It is strongly recommended to enable the watchdog function.
---	--

Click **Save** and follow the UI instruction to apply changes and reboot the device for apply all the modified settings.

System

System | Administrator

The **System | Administrator** menu is for changing the administrator’s settings: username and password:

Administrator	
User Name	<input type="text" value="admin"/>
Old Password	<input type="text"/>
New Password	<input type="text"/>
Confirm Password	<input type="text"/>
<input type="button" value="Save"/> <input type="button" value="Cancel"/>	

Figure 107 – system security settings

User Name – administrator username for access to BW1254 (e.g. web interface, CLI mode) [1-32 symbols, spaces not allowed]

Old Password – old password

New Password – new password value used for user authentication in the system [4-8 characters, spaces not allowed]

Confirm Password – re-enter the new password to verify its accuracy

Save – click to save new administrator settings.

	Default administrator logon settings are: User Name: admin Password: admin01
---	--

	Password length is from 4 to 8 characters.
---	--

After filling in the right Old password and the New Password, clicking the **Save** button for taking effect immediately.

After clicking **Save** button, the below UI will be shown to notify that the new password setting has been taken place:

Set password successfully.

Administrator	
User Name	<input type="text" value="admin"/>
Old Password	<input type="text"/>
New Password	<input type="text"/>
Confirm Password	<input type="text"/>
<input type="button" value="Save"/> <input type="button" value="Cancel"/>	

Figure 108 – system security settings save and take effect successfully

System | System Log

Use the **System | System Log** menu to trace your AP system processes and get the system log locally or on the remote log server.

Remote System Log			
Remote Log Status	Host IP	Log Level	Action
Disabled	192.168.2.1	info	Edit

Local System Log			
Local Log Status	Log Limit (bytes)	Log Level	Action
Enabled	102400	debug	Edit
View Log Messages			View

Figure 109 – System Log settings

To enable the **System Log** remote sending function, click the **Edit** button on the Remote System Log table and choose the **enabled** option:



Remote System Log			
Remote Log Status	Host IP	Log Level	Action
Enabled <input type="button" value="v"/>	192.168.2.1	Info <input type="button" value="v"/>	Save Cancel

Figure 110 – Configure Remote System Log Utility

Remote Log Status – choose disable/enable remote log function.[enabled/disabled]

Host IP – specify the host IP address where to send the **System Log** messages [dots and digits]

Log Level – specify the remote log message level you want to trace [critical, error, warning, info and debug]

	Do not output “debug” log unless there are important issue needs to be clarified. Debug log will output all of the information so that it will severely drop down the network performance.
	BW1254 support standard sys. log server.

Save – save changes

Cancel – restore the previous values

To view the **System Log** locally, click the **Edit** button on the Local System Log table and choose the **enabled** option:

Local System Log			
Local Log Status	Log Limit (bytes)	Log Level	Action
Enabled <input type="button" value="v"/>	102400	Debug <input type="button" value="v"/>	Save Cancel
View Log Messages			View

Figure 111 –Configure Local System Log

Local Log Status – choose disable/enable local log [enabled/disabled]

Log Limit – specify the maximum length of local log message in byte [20000-512000]

Log Level – specify the local log message level you want to trace [critical, error, warning, info and debug]

Save – save changes

Cancel – restore the previous values

View – view the log messages locally

Click **View** button, a similar screen will appear as below:

Local Log Messages	
Messages	Action
Clear All Log Messages:	<input type="button" value="Clear"/>
Jan 1 03:17:59 P720 [G8000]: messages is null, so continue	
Jan 1 03:18:05 P720 last message repeated 3 times	
Jan 1 03:18:08 P720 [G8000]: cmd is equal to refreshlog button	
Jan 1 03:18:08 P720 [G8000]: messages is null, so continue	
<input type="button" value="Refresh"/> <input type="button" value="Return"/>	

Figure 112 – View Local Log Messages

Clear – clear current log message

Refresh – get the updated log messages

Return – back to System Log page

System | System Mode

In this page, you can select the system mode of your BW1254.

System Mode					
Mode	Interface	IP	Netmask	Gateway	Protocol
<input checked="" type="radio"/> AP					
	LAN	<input type="text" value="192.168.123.159"/>	<input type="text" value="255.255.255.0"/>	<input type="text" value="192.168.123.1"/>	<input type="text" value="static"/> ▾
<input type="radio"/> AP Router					
	WAN	<input type="text" value="192.168.123.159"/>	<input type="text" value="255.255.255.0"/>	<input type="text" value="192.168.123.1"/>	<input type="text" value="static"/> ▾
<input type="button" value="Apply and Reboot"/>					

Figure 113 – System Mode Settings

Mode – select whether the system mode of BW1254 is AP mode or AP Router mode

AP – The Ethernet interface and wireless interface will bridge into the same interface working as transparent access point.

AP Router – A wireless router is a device that performs the functions of a router but also includes the functions of a wireless access point. Under this mode the Ethernet will act as WAN interface and wireless interface will be act as LAN.

IP – specify the IP address of current interface [dots and digits]

Netmask – specify the subnet mask of current interface [dots and digits]

Gateway – specify the gateway to other networks

Protocol – specify **static** for setting IP address manually and **dhcp** for getting IP address dynamically acting as DHCP client

Apply and Reboot – click the button to restart the device and apply all setting changes

	The BW1254 Web Interface in AP mode is different from that in AP-Router mode. For the detailed configuration of BW1254 working in AP-Router mode, please refer to the next chapter: Chapter 4 – Reference Manual----AP-Router Mode
---	---

System | System Info

Administrator can self-define the device information including the system name, system location and system contact information of his BW1254.

System Info		
Name	Value	Action
System Name	BW1254	<input type="button" value="Edit"/>
System Location	location	<input type="button" value="Edit"/>
System Contact	contact information	<input type="button" value="Edit"/>

Figure 114 – System info Settings

System Name – edit the system name, the column length range is 1 to 255.

System Info		
Name	Value	Action
System Name	<input type="text" value="BW1254"/>	<input type="button" value="Save"/> <input type="button" value="Cancel"/>
System Location	location	
System Contact	contact information	

Figure 115 –edit the system name

System Location – edit the system location, the column length range is 1 to 255.

System Info		
Name	Value	Action
System Name	BW1254	
System Location	<input type="text" value="Taipei 101"/>	<input type="button" value="Save"/> <input type="button" value="Cancel"/>
System Contact	contact information	

Figure 116 –edit the system location

System Contact – edit the system contact, the column length range is 1 to 255.

System Info		
Name	Value	Action
System Name	BW1254	
System Location	Taipei 101	
System Contact	<input type="text" value="Timothy#2651"/>	<input type="button" value="Save"/> <input type="button" value="Cancel"/>

Figure 117 –edit the system contact

Save – click the button to save the change.

Cancel – restore all previous values

System | Configuration

Use the **System | Configuration** menu to download current configuration or restore specified configuration.

Configuration Backup – download current working system configuration for backup

Configuration Upload – upload system configuration for restore

Configuration Backup	
Description	Action
Configuration file to download	<input type="button" value="Preparation"/>

Configuration Upload	
Description	Action
Configuration file to upload	<input type="text"/> <input type="button" value="Browse..."/>
<input type="button" value="Upload"/> <input type="button" value="Cancel"/>	

Figure 118 – System Configuration settings

Click the **Preparation** button to start saving the configuration file.

Click the **Download** button to download current working configuration locally.

Configuration Backup	
Description	Action
Download and store Configuration backup file in safe place.	<input type="button" value="Download"/>

Figure 119 – Backup settings

By default the device configuration name is cfgbackup.cfg.

	<p>A configuration file name will be required when you download/save the configuration file. And please remember or re-name the file if necessary. The configuration file name should only include characters or numbers. Otherwise, this configuration file will not upload to BW1254.</p>
---	---

You can upload saved configuration file any time you want to restore this configuration to the device by using the **Browse** button. Select the configuration file and upload it on the device:

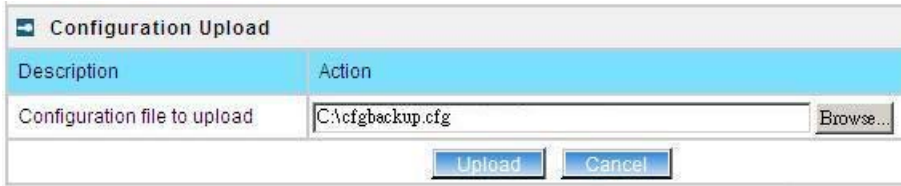

Figure 120 – Configuration Upload/Restore - 1

Click **Upload** for upload the specified configuration and then the similar UI appears

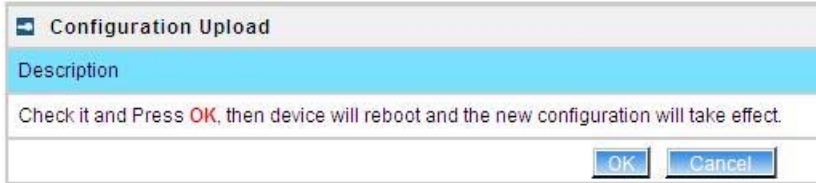

Figure 121 – Configuration Upload/Restore - 2

Click **OK** button to restore and AP will reboot immediately to take effect.

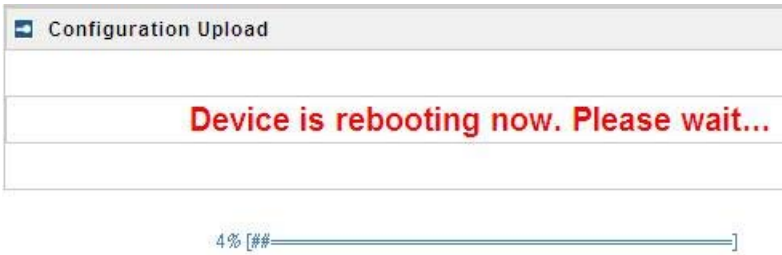

Figure 122 – Configuration Upload/Restore - 3

System | Reset and Reboot

Use this function to reboot device or restore to factory default.

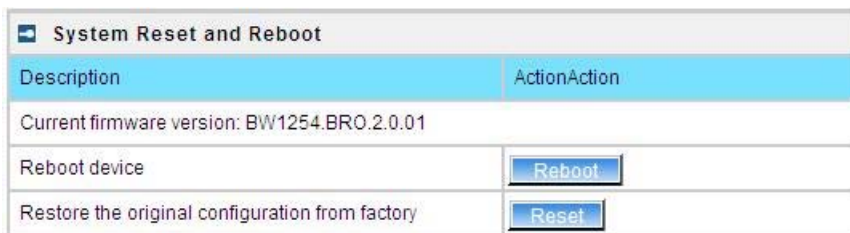

Figure 123 – System Reset setting

Reboot – reboot the device

Reset – reset System to Factory Defaults

To reboot the device, click **Reboot** and then the below appears to make sure:



Figure 124 – Reboot the device

To reset the device, click **Reset** and then the below appears to make sure:

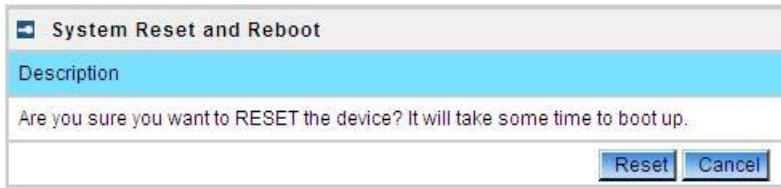
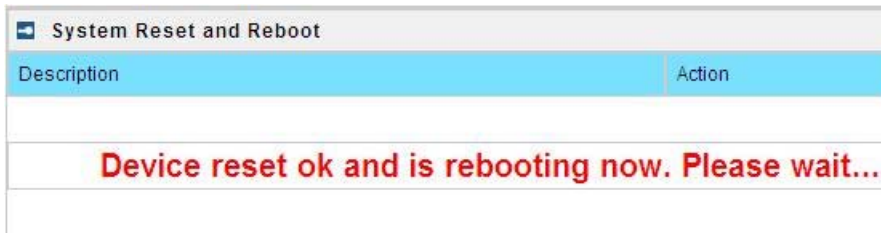



Figure 125 – Reset the device

Click reset button the device will reset and reboot immediately to take effect.



	<p>Please note that all settings including the administrator settings will be set back to the factory default when Reset is implement.</p>
---	---

System | Local Upgrade

Upload – Update your device firmware locally.

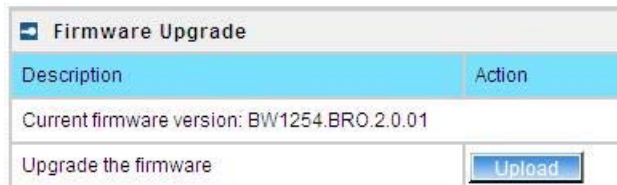

Figure 126 – Firmware Upgrade

Click the **Upload** and then click the browse button to specify the full path of the new firmware image and click the **Upload** button:

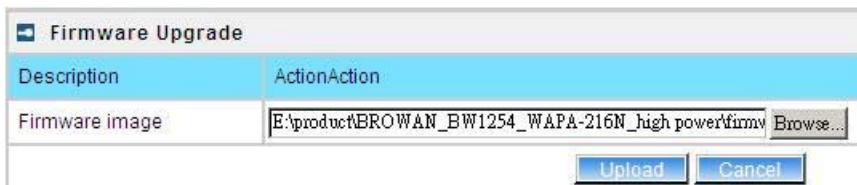



Figure 127 – Firmware Upgrade

Click the **Upgrade** button to flash and upgrade the firmware.

	<p>Please make sure the firmware is correct for BW1254. Otherwise the upgrade will be failed.</p>
---	---

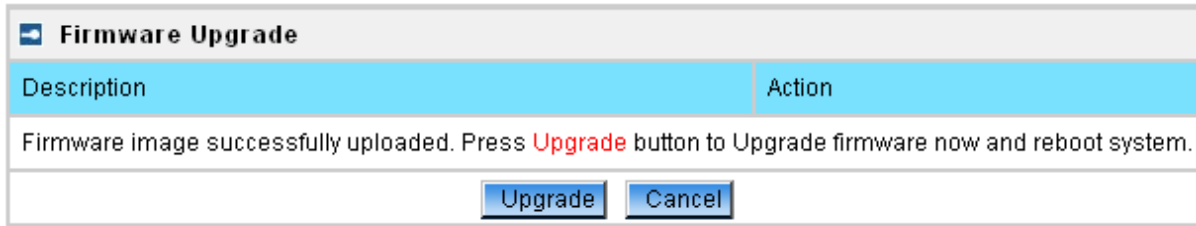
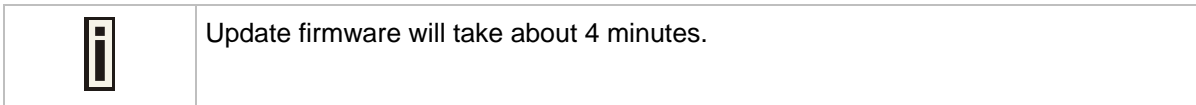
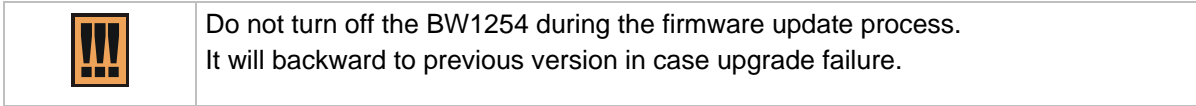

Figure 128 – upgrade firmware



System | TFTP Upgrade

BW1254 support firmware upgrade via TFTP server.



Figure 129 – TFTP Firmware Upgrade

Current firmware version – Show the current firmware version.

TFTP server IP address - Specify the IP address of TFTP server which firmware located.

TFTP Time Out(Seccs) – Specify the TFTP server communication time out in second.

Firmware Filename – Specify the upgrade firmware name to be download.

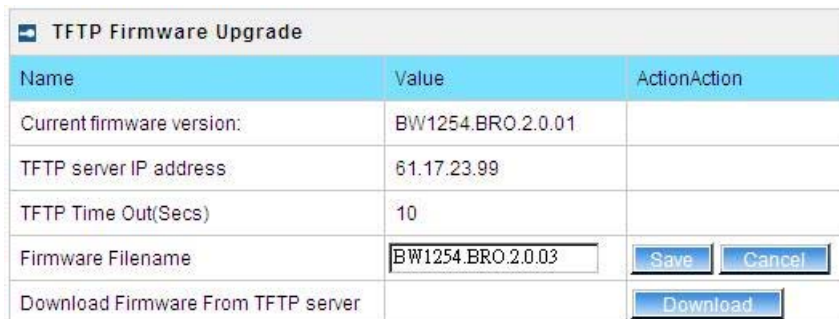



Figure 130 – TFTP Firmware Upgrade setting

Click “Edit” button to specify the TFTP server IP address,time out interval and firmware filename and save the configuration then press “Download” button to download the firmware.

	Please make sure the firmware is correct for BW1254. Otherwise the upgrade will be failed.
---	--

	Do not turn off the BW1254 during the firmware update process. It will backward to previous version in case upgrade failure.
---	--

System | Location Settings

You can define the longitude and latitude for the device information or for the NMS to locate the device location.

Location Settings	
Name	Value
Longitude	
Latitude	
<input type="button" value="Edit"/>	

Figure 131 – location setting

Click edit to enter the Longitude and Latitude in digit and dot format.

Location Settings	
Name	Value
Longitude	<input type="text" value="121.524611"/>
Latitude>	<input type="text" value="25.040917"/>
<input type="button" value="Save"/> <input type="button" value="Cancel"/>	

Figure 132 – edit location[longitude/latitude]

Click **save** button to save it.

Chapter 4 – Reference Manual----AP-Router Mode

This chapter describes the configuration of the BW1254 which works in AP-Router mode using the Web Interface.



The BW1254 Web Interface in AP-Router mode is different from that in AP mode. To change your BW1254 to AP mode, please refer to **System | System Mode**. For the detailed configuration of BW1254 working in AP mode, please refer to: **Chapter 3 – Reference Manual----AP Mode**

The **web management** main menu consists of the following sub menus:

- **Status** – device status showing
- **Network** – device settings affecting networking
- **Wireless** – device settings related to the wireless part of the BW1254
- **User** – device settings affecting the user interface
- **Services** – networking service settings of the BW1254
- **System** – device system settings directly applicable to the BW1254
- **Exit** – click exit and leave the web management then close your web-browser window.

Web Interface

The main **web management** menu is displayed at the top of the page after successfully logging into the system (see the figure below). From this menu all essential configuration pages are accessed.



Figure 133 – Main Configuration Management Menu

The **web management** menu has the following structure:

Status

Device Status – show the status related with the whole device

Wireless Status – show the status of the wireless

Interface Statistics – show the status of each network interface

Network

Interface – TCP/IP settings of BW1254

PPPoE – Configure the PPPoE tunnel

L2TP – Configure the L2TP tunnel

RADIUS Server – specify the accounting/authentication RADIUS server which is used by 802.1x or WPA

RADIUS Properties – specify the settings of the RADIUS properties, includes NAS server ID, RADIUS Retries and other settings

DNS – define DNS server settings

DHCP – specify the settings of DHCP server or DHCP relay service

DHCP Lease –display the DHCP lease information

Static Route – define new static route

Attack Countermeasure – Anti-attack settings for protecting BW1254

Link Integrity – specify the status and settings of link integrity feature.

Tr069 settings – configure the remote management through TR069 ACS server(BROWAN DMS server)

Wireless

Basic – specify the basic settings related with wireless part

Advance – specify the settings of multiple BSSID or Bridge

WEP – specify the WEP settings related with static WEP encryption

MAC ACL – MAC ACL settings for BW1254

Load Balance – specify the load balance settings of BW1254

User

Users – show the connected users' statistics list and log-out user function

Station Supervision – monitor station availability with ARP-pings settings

User ACL – define packet filter rules

Walled Garden –free web site list

WISP – add new WISP on the system

Start Page – define start page URL

Customized UAM – customized user login and logout page based by HTML page

Pages –configure and upload user pages

Upload –upload new internal user pages

HTTP Headers –define http headers encoding and language

Remote Authentication – define external Web Application Server (WAS) to intercept/take part in the user authentication process

Services

Telnet – Telnet/SSH service

SNMP – SNMP service

NTP – NTP settings of BW1254

Time – manually set time

Watchdog – Enable the S/W or H/W watchdog of BW1254

System

Administrator – set access permission to your BW1254

System Log – check the system log locally or specify address where to send system log file

System Mode – specify whether the BW1254 works in AP mode or in AP router mode

System Info – specify some device related information for BW1254

Configuration – system configuration utilities, including Backup/Upload configuration

Reset & Reboot – reboot device and restore systems to factory default

Local Upgrade –upgrade firmware from local PC

TFTP Upgrade –upgrade firmware from tftp server

Location settings – define AP location(Longitude/Latitude)

In the following sections, short references for all menu items are presented.

Status

Status | Device Status

The **Device Status** page shows important information of system status and network configuration for the BW1254.

System	
System Mode	AP-Router
System Version	BW1254.BRO.2.0.03
Config Version	BW1254.BRO.2.0.03
Up Time	0 day(s) 00:00
System Time	1970/01/01/ 00:00
WLAN1 MAC	00:16:16:20:40:68
WLAN2 MAC	20:10:7A:D3:B2:95
Free System Memory	12,140 K bytes
Total System Memory	47,500 K bytes

Network	
WAN Mode	static-IP
WAN MAC	00:16:16:20:40:69
WAN IP	192.168.21.165
WAN Mask	255.255.255.0
Gateway	192.168.21.1

Figure 134 – Device Status

System Mode – display the BW1254 works in AP mode or AP-Router mode

System Version – display the current version of the firmware loaded to the AP

	This is important information for support requests and for preparing firmware upgrading
---	---

Config version – display current configure version

Up Time – indicate the time, expressed in days, hours and minutes since the system was last rebooted

System Time – show the current time of the BW1254

WLAN1 MAC – show the MAC addresses of the wireless interfaces of the BW1254[2G]

WLAN2 MAC – show the MAC addresses of the wireless interfaces of the BW1254[5G]

Free System Memory – indicate the memory currently available in the BW1254

Total System Memory – indicate the total memory in the BW1254

WAN Mode – indicate static IP or DHCP client is used for BW1254 WAN IP address

WAN IP – show the WAN IP address of BW1254

WAN Mask – show the WAN Network Mask of BW1254

Gateway – show the default gateway of BW1254

Status | Wireless Status

The *wireless status* shows the information related with BW1254 wireless interfaces.

Radio1	
Channel	Current Frequency:2.462 GHz (Channel 11)
Domain	WORLD
Mode	AP
Band	2.4GHz(11ng HT20)
Total Connected Clients	0
TxPower	14dBm
MAC ACL	disabled
SSID Number	1

Figure 135 – Wireless Status

Radio1 – show the wireless interface.

Channel – indicate which channel is in use.

Domain – indicate regulatory domain set on the BW1254

Mode – AP or Bridge mode is be used for this wireless interface

Band – specify which band is in use for wireless interface

Total Connected Clients – indicate number of the currently connected clients to your BW1254

Tx Power – indicate radio transmit power of the BW1254

MAC ACL – indicate the status of MAC ACL feature on BW1254

SSID Number – indicate current number of enabled SSID on BW1254

Status | Interface Statistics

The *Interface Statistics* shows each network interface status, including Input / Output bytes, packets or error.

Interface Statistics						
Interface Name	Input Bytes(KB)	Input Packets	Input Errors	Output Bytes(KB)	Output Packets	Output Errors
eth1	913	12399	0	323	595	0

[Refresh](#)

Figure 136 – Interface Statistics

Interface Name – show the name of each network interface, where ixp0 is related to LAN interface, wlan1_x is related to wireless sub-interface.

Input Bytes (KB) – show the total number of bytes received on the network interface. The bytes number is displayed in KB.

Input Packets – show the packets number received on the network interface.

Input Errors – show the packets number which contain errors preventing them from being received correctly.

Output Bytes (KB) – show the total number of bytes transmitted out of the network interface. The bytes number is displayed in KB.

Output Packets – show the packets number transmitted out of the network interface.

Output Errors – show the packets number which contain errors preventing them from being transmitted out correctly.

Refresh – get the updated network interface information.

Network

Network | Interface

The AP-Router contains two kinds of network interfaces: eth1 is worked as wide area network (WAN) interface for Access Points; each BSS interface is worked as local area network (LAN) interface which bridge into the br0 interface. The WAN port connects to the Internet or the service provider's backbone network. Each BSS can be looked as a virtual AP, wlan1_0 is the virtual AP for wireless network.

All these interfaces are listed in the **Network Interfaces** page. All network interfaces available in the AP-Router are shown in the following table:

Network Interfaces								
Interface	Status	Type	IP Address	Netmask	Gateway	NAT	Web Auth	Action
br0	enabled	LAN	192.168.3.1	255.255.255.0	eth1	enabled	enabled	Edit
eth1	enabled	WAN	192.168.21.162	255.255.255.0	*192.168.21.1	---	---	Edit

You may check the 'Static Route' settings, when modify interface settings!!! Or some route settings will be invalid.

Figure 137 – Network Interface Table

To change network interface configuration properties click the **Edit** button in the **Action** column. The **status** can be changed now:

Network Interfaces								
Interface	Status	Type	IP Address	Netmask	Gateway	NAT	Web Auth	Action
br0	<input type="button" value="enabled"/>	LAN	192.168.3.1	255.255.255.0	eth1	<input type="button" value="enabled"/>	<input type="button" value="enabled"/>	Continue Cancel
eth1	enabled	WAN	192.168.21.162	255.255.255.0	*192.168.21.1	---	---	

You may check the 'Static Route' settings, when modify interface settings!!! Or some route settings will be invalid.

Figure 138 – Edit Network Interfaces Settings - 1

Interface – standard interface name. This name cannot be edited

Status – select the status of interface [enabled/disabled]

	Do not disable the interface through which you are connected to the AP Router. Disabling such interface will lose your connection to the device.
---	--

	The interface eth1 can not be disabled.
---	---

Type – network type cannot be changed. There are two possible networking types:

LAN – interface is used as local area network (LAN) gateway, and is connected to a LAN

WAN – interface is used to access the ISP network

NAT – select enable/disable the NAT service of current interface. If enabled, users can access the Internet under its network gateway address [enabled/disabled]

Web Auth – select enable/disable the Web Login Authentication of current interface. With disabled authentication, the user from his LAN gets access to the Internet without any authentication. If enabled, authentication for Internet access is required for all users [enabled/disabled]

Change **status** or leave in the default state if no editing is necessary and click the **Continue** button. Then the following parameters can be changed:

Network Interfaces								
Interface	Status	Type	IP Address	Netmask	Gateway	NAT	Web Auth	Action
eth1	enabled	WAN	192.168.2.2	255.255.255.0	*192.168.2.1	---	---	
br0	enabled	LAN	<input type="text" value="192.168.3.1"/>	<input type="text" value="255.255.255.0"/>	<input type="text" value="eth1"/>	enabled	enabled	<input type="button" value="Save"/> <input type="button" value="Cancel"/>

You may check the 'Static Route' settings, when modify interface settings!!! Or some route settings will be invalid.

Figure 139 –Edit Interface Configuration Settings - 2

IP Address – specify new interface IP address [dots and digits]



Under ap-router mode, IP address of each interface should be configured different subnet; otherwise, you will receive an error message.

Netmask – specify the subnet mask [[0-255].[0-255].[0-255].[0-255]]. These numbers are a binary mask of the IP address, which defines IP address order and the number of IP addresses in the subnet

Gateway – interface gateway. For LAN type interfaces, the gateway is WAN interface. The gateway of the WAN interface is usually the gateway router of the ISP or other WAN network [Default gateway is marked with '*']

Save – save the entered values.

Cancel – restore all previous values.

Network Interfaces								
Interface	Status	Type	IP Address	Netmask	Gateway	NAT	Web Auth	Action
eth1	enabled	WAN	192.168.2.2	255.255.255.0	*192.168.2.1	---	---	<input type="button" value="Edit"/>
br0	enabled	LAN	192.168.3.1	255.255.255.0	eth1	enabled	enabled	<input type="button" value="Edit"/>

You may check the 'Static Route' settings, when modify interface settings!!! Or some route settings will be invalid.

Figure 140 – Apply or Discard Interface Configuration Changes

Apply Changes – save all changes in the **interface** table at once.

Discard Changes – restore all previous values.

For such change of settings, the BW1254 needs to be restarted to apply all settings changes when clicking **Apply Changes**. Request for reboot server appears:

Network Interfaces								
Interface	Status	Type	IP Address	Netmask	Gateway	NAT	Web Auth	Action
eth1	enabled	WAN	192.168.2.2	255.255.255.0	*192.168.2.1	---	---	Edit
br0	enabled	LAN	192.168.3.1	255.255.255.0	eth1	enabled	enabled	Edit

You may check the 'Static Route' settings, when modify interface settings!!! Or some route settings will be invalid.

[Reboot](#)

System needs to be restarted to make the new configurations take effect.

Figure 141 – Reboot Server

Reboot – click the button to restart the server and apply the changes.



If there is no other settings needed to be modified, click the **Reboot** button to apply all changes. If there are any other settings need to be changed, continuously to finish and apply all changes and then click **Reboot** button to restart and take effect for all settings.

Network | PPPoE

The Point-to-Point Protocol over Ethernet(PPPoE) is a network protocol for encapsulating PPP frames inside Ethernet frames. It is use mainly for DSL service.

Click Edit button to enable or disable the service.

PPPoE	
Name	Status
Status	Disabled
Edit	

Figure 142 – PPPoE service

Name – service name

Status – change status for this service.[disable/enable]

PPPoE	
Name	Status
Status	Disabled <input type="button" value="v"/>
Save Cancel	

Figure 143 – change PPPoE service

Enable the PPPoE service.

Username – enter the authorized user to connect to the server [text string, can not be empty].



The same username should be configured on the PPPoE server.

Password – the password of the user. [text string, can not be empty]

PPPoE	
Name	Status
Status	Enabled
Username	pppoe_user
Password	pppoe_passwd
<input type="button" value="Save"/> <input type="button" value="Cancel"/>	

Figure 144 – edit PPPoE service

i Default WAN gateway specified in **Network | Interface** page will not be used, because all Internet traffic will be sent/received via the specified PPPoE server (tunnel).

Click **Save** and **Apply Changes** button to take effect the changes.

PPPoE	
Name	Status
Status	Enabled
Username	pppoe_user
Password	pppoe_passwd
<input type="button" value="Edit"/>	

Figure 145 – apply changes

Reboot – click the button to restart the AP and apply all the changes.

PPPoE	
Name	Status
Status	Enabled
Username	pppoe_user
Password	pppoe_passwd
<input type="button" value="Edit"/>	

System needs to be restarted to make the new configurations take effect.

Figure 146 – reboot and take effect all changes

i If there is no other settings needed to be modified, click the **Reboot** button to apply all changes. If there are any other settings need to be changed, continuously to finish and apply all changes and then click **Reboot** button to restart and take effect for all settings.

Network | L2TP

Layer 2 Tunneling Protocol(L2TP) is a tunneling protocol used to support virtual private networks (VPNs) or as part of the delivery of services by ISPs. It does not provide any encryption or confidentiality by itself. Rather, it relies on an encryption protocol that it passes within the tunnel to provide privacy.

Click Edit button to enable or disable the service.



L2TP	
Name	Status
Status	Disabled
<input type="button" value="Edit"/>	

Figure 147 – L2TP services

Name – service name

Status – change status for this service.[disable/enable]

Server IP – enter the server IP address. [in digits and dots notation, e.g. 192.168.2.2]

Username – enter the user name.

Password – password for the authorized user.

Timeout – in case of connection fail, the interval to re-connect to the server.

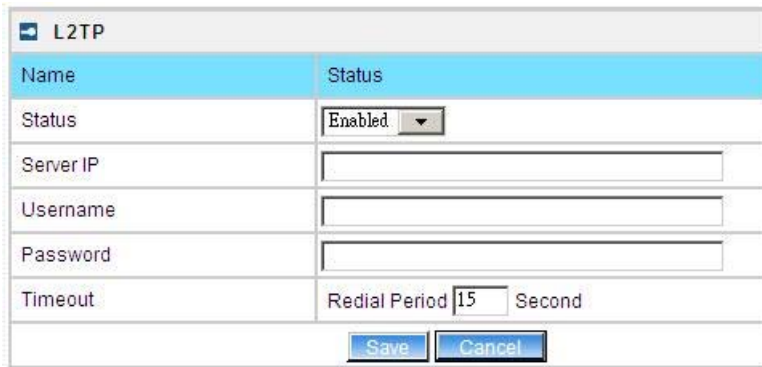

L2TP	
Name	Status
Status	Enabled <input type="button" value="v"/>
Server IP	<input type="text"/>
Username	<input type="text"/>
Password	<input type="text"/>
Timeout	Redial Period <input type="text" value="15"/> Second
<input type="button" value="Save"/> <input type="button" value="Cancel"/>	

Figure 148 – edit L2TP services

Click **Save** button and **Apply Changes** button to save the change or **discard changes** button to discard the change

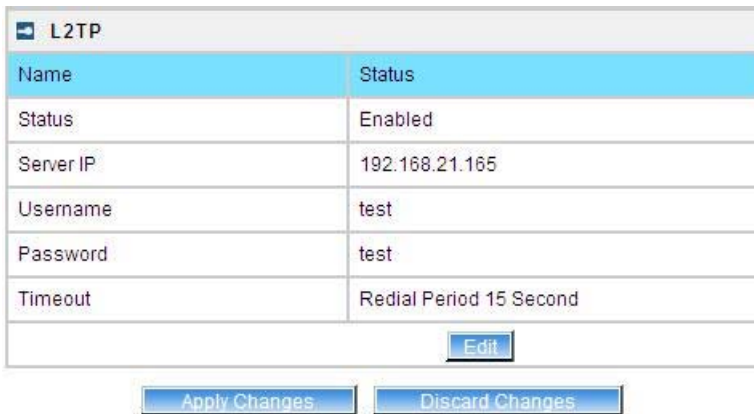

L2TP	
Name	Status
Status	Enabled
Server IP	192.168.21.165
Username	test
Password	test
Timeout	Redial Period 15 Second
<input type="button" value="Edit"/>	
<input type="button" value="Apply Changes"/> <input type="button" value="Discard Changes"/>	

Figure 149 – save the changes

Reboot – click the button to restart the AP and apply all the changes.

L2TP	
Name	Status
Status	Enabled
Server IP	192.168.21.165
Username	test
Password	test
Timeout	Redial Period 15 Second
<input type="button" value="Edit"/>	
<input type="button" value="Reboot"/>	

System needs to be restarted to make the new configurations take effect.

Figure 150 – reboot and take effect the changes



If there is no other settings needed to be modified, click the **Reboot** button to apply all changes. If there are any other settings need to be changed, continuously to finish and apply all changes and then click **Reboot** button to restart and take effect for all settings.

Network | RADIUS Server



Up to **32** different RADIUS servers can be configured in the **RADIUS servers** menu.

By default, one **RADIUS** server is specified for the system:

RADIUS Server					
Name	Type	IP Address	Port	Secret	Action
DEFAULT (default)	Authentication	0.0.0.0	1812	secret	<input type="button" value="Details"/> <input type="button" value="Edit"/> <input type="button" value="Delete"/>
	Accounting	0.0.0.0	1813	secret	
<input type="button" value="Add"/>					

Figure 151 – RADIUS Servers Settings

Details – show the detail information of this **RADIUS Server** profile

Edit – edit the selected **RADIUS Server** entry you want to configure

Delete – delete the selected **RADIUS Server** entry. The last entry can not be deleted

Add – add new RADIUS server.

Click **Details**, a similar page will be appeared as below:

RADIUS Server	
Description	Value
Name (default)	DEFAULT
Authentication IP	192.168.123.200
Authentication Port	1812
Authentication Secret	secret
Accounting IP	192.168.123.201
Accounting Port	1813
Accounting Secret	secret
User Password Md5sum Secret	disabled
<input type="button" value="Back"/> <input type="button" value="Edit"/>	

Figure 152 – Detail for Radius Server profile

Name – the new RADIUS server name which is used for selecting RADIUS server

	If a “(default)” appears on the right side of the Name entry, it means this RADIUS server profile is the default profile.
--	--

Authentication IP – show the IP address of Authentication RADIUS server

Authentication Port – show the network port used to communicate with the Authentication RADIUS server

Authentication Secret – show the shared secret string that is used to make sure the integrity of data frames used for the Authentication RADIUS server

Accounting IP – show the IP address of Accounting RADIUS server

	If the Accounting IP address is 0.0.0.0, it means that the Accounting service is disabled.
---	--

Accounting Port – show the network port used to communicate with the Accounting RADIUS server

Accounting Secret – show the shared secret string that is used to make sure the integrity of data frames used for the Accounting RADIUS server

User Password Md5sum Secret – show whether user input password is calculated md5-sum before pass to RADIUS server or not.

Back – back to the **RADIUS Server** main page

Edit – edit the selected **RADIUS Server** profile

Click **Edit** or click **Add / Edit** button in the main page to configure RADIUS server settings.

RADIUS Server	
Description	Value
Name	DEFAULT
Default	<input checked="" type="checkbox"/>
Authentication IP	192.168.123.100
Authentication Port	1812
Authentication Secret	secret
Accounting IP	192.168.123.200
Accounting Port	1813
Accounting Secret	secret
User Password Md5sum Secret	disabled
<input type="button" value="Save"/> <input type="button" value="Cancel"/>	

Figure 153 – Edit the RADIUS Server's profile

RADIUS Server	
Description	Value
Name	<input type="text"/>
Default	<input type="checkbox"/>
Authentication IP	<input type="text"/>
Authentication Port	<input type="text"/>
Authentication Secret	<input type="text"/>
Accounting IP	<input type="text"/>
Accounting Port	<input type="text"/>
Accounting Secret	<input type="text"/>
User Password Md5sum Secret	disabled
<input type="button" value="Save"/> <input type="button" value="Cancel"/>	

Figure 154 – Add a new RADIUS Server's profile

Name – specify the new RADIUS server name which is used for selecting RADIUS server

Default – specify this RADIUS profile as default or not. When selected, the profile will be used as default

Authentication IP – specify the IP address of Authentication RADIUS server [dots and digits]

Authentication Port –specify the network port used to communicate with the Authentication RADIUS server [1-65535]

Authentication Secret – shared secret string that is used to make sure the integrity of data frames used for the Authentication RADIUS server

Accounting IP – specify the IP address of Accounting RADIUS server [dots and digits]

Accounting Port –specify the network port used to communicate with the Accounting RADIUS server [1-65535]

Accounting Secret – shared secret string that is used to make sure the integrity of data frames used for the Accounting RADIUS server

	<p>The default port value for authentication is 1812. The default port value for accounting is 1813. The port specified here must be the same with the one on the RADIUS server.</p>
---	--

User Password Md5sum Secret – if enabled, user input password will be calculated md5-sum before pass to RADIUS server for more security [enabled/disabled]

	<p>This setting needs RADIUS server do relevant configurations.</p>
---	---

Save –save the entered values

Cancel – restore all previous values

After adding a new RADIUS server or editing an existing one, a page appears similar to the following:

RADIUS Server					
Name	Type	IP Address	Port	Secret	Action
DEFAULT (default)	Authentication	192.168.123.100	1812	secret	<input type="button" value="Details"/> <input type="button" value="Edit"/> <input type="button" value="Delete"/>
	Accounting	192.168.123.200	1813	secret	
<input type="button" value="Add"/>					

<input type="button" value="Apply Changes"/>	<input type="button" value="Discard Changes"/>
--	--

Figure 155 – Apply or Discard RADIUS Server Changes

Details – show the detail information of this **RADIUS Server** profile

Edit – edit the selected **RADIUS Server** entry you want to configure

Delete – delete the selected **RADIUS Server** entry. The last entry can not be deleted

Add – add new RADIUS server.

Apply Changes – to save all changes at once.

Discard Changes – restore all previous values.

Click **Apply Changes** to apply all the changes. Then the follow similar page will appear:

RADIUS Server					
Name	Type	IP Address	Port	Secret	Action
DEFAULT (default)	Authentication	192.168.123.100	1812	secret	<input type="button" value="Details"/> <input type="button" value="Edit"/> <input type="button" value="Delete"/>
	Accounting	192.168.123.200	1813	secret	
<input type="button" value="Add"/>					

System needs to be restarted to make the new configurations take effect.

Figure 156 – Reboot Server

Reboot – restart the access point to make applied changes work.

	If there is no other settings needed to be modified, click the Reboot button to apply all changes. If there are any other settings need to be changed, continuously to finish and apply all changes and then click Reboot button to restart and take effect for all settings.
---	---

Network | RADIUS Properties

General **RADIUS** settings are configured using the **RADIUS Properties** menu under the **network**:

RADIUS Properties		
Setting	Value	Action
RADIUS Retries	5	<input type="button" value="Edit"/>
RADIUS Timeout (seconds)	2	<input type="button" value="Edit"/>
NAS Server ID		<input type="button" value="Edit"/>
User Session Timeout (seconds)	72000	<input type="button" value="Edit"/>
User Accounting Update Interval (seconds)	600	<input type="button" value="Edit"/>
User Accounting Update Retry (seconds)	60	<input type="button" value="Edit"/>
User Idle Timeout (seconds)	900	<input type="button" value="Edit"/>
Bandwidth Up (ex. 100000, 10kbps, 10m)	512 Kbps	<input type="button" value="Edit"/>
Bandwidth Down (ex. 100000, 10kbps, 10m)	512 Kbps	<input type="button" value="Edit"/>

Figure 157 – RADIUS Properties settings

RADIUS Retries – retry count of sending RADIUS packets before giving up [0-99]

RADIUS Timeout (seconds) – maximum amount of time before retrying RADIUS packets [1-999]

NAS Server ID – name of the RADIUS client

User Session Timeout (seconds) – amount of time from the user side (no network carrier) before closing the connect [1-999999999]

User Accounting Update Interval (Seconds) – period after which server should update accounting information [60-999999999]

User Accounting Update Retry (seconds) – retry time period in which server should try to update accounting information before giving up [60-999999999]

User Idle Timeout (seconds) – amount of user inactivity time, before automatically disconnecting user from the network [1-999999999]

Bandwidth Up – maximum bandwidth up at which corresponding user is allowed to transmit [bps]

Bandwidth Down – maximum bandwidth down at which corresponding user is allowed to receive [bps]

Each setting in this table can be edited. Select **RADIUS** setting you need to update, click the **edit** next to the selected setting and change the value:

RADIUS Properties		
Setting	Value	Action
RADIUS Retries	5	
RADIUS Timeout (seconds)	2	
NAS Server ID		
User Session Timeout (seconds)	72000	
User Accounting Update Interval (seconds)	600	
User Accounting Update Retry (seconds)	60	
User Idle Timeout (seconds)	900	
Bandwidth Up (ex. 100000, 10kbps, 10m)	<input type="text" value="99 Mbps"/>	<input type="button" value="Save"/> <input type="button" value="Cancel"/>
Bandwidth Down (ex. 100000, 10kbps, 10m)	512 Kbps	

Figure 158 – edit RADIUS properties

Use the **save** button to save an entered value. Now select another **RADIUS** property to edit, or **Apply Changes** and restart your AP if the configuration is finished:

RADIUS Properties		
Setting	Value	Action
RADIUS Retries	5	Edit
RADIUS Timeout (seconds)	2	Edit
NAS Server ID		Edit
User Session Timeout (seconds)	72000	Edit
User Accounting Update Interval (seconds)	600	Edit
User Accounting Update Retry (seconds)	60	Edit
User Idle Timeout (seconds)	900	Edit
Bandwidth Up (ex. 100000, 10kbps, 10m)	99 Mbps	Edit
Bandwidth Down (ex. 100000, 10kbps, 10m)	512 Kbps	Edit

[Apply Changes](#) [Discard Changes](#)

Figure 159 – apply change RADIUS properties

Apply Changes – click if **RADIUS Properties** configuration is finished

Discard Changes – restore all previous values

Network | DNS

DNS (Domain Name Service) service allows BW1254 subscribers to enter URLs instead of IP addresses into their browser to reach the desired web site. You can enter the **DNS** server settings under the **Network | DNS** menu. The DNS server settings table is displayed:

DNS		
Type	IP Address	Action
primary	0.0.0.0	Edit
secondary	0.0.0.0	Edit

Figure 160 – DNS Settings

You can enter the **primary** and **secondary DNS** servers' settings by click the **edit** button in the **action** column and type in the **DNS** server's IP address:

DNS		
Type	IP Address	Action
primary	<input type="text" value="202.96.209.5"/>	Save Cancel
secondary	0.0.0.0	

Figure 161 – Edit DNS Settings

IP Address – enter the primary or secondary DNS server’s IP address [dots and digits]

Change status or leave in the default state if no editing is necessary and click the **Save** button.

DNS		
Type	IP Address	Action
primary	202.96.209.5	Edit
secondary	202.96.209.13	Edit

[Apply Changes](#) [Discard Changes](#)

Figure 162 – Apply or Discard DNS server Settings

For each change of settings, the BW1254 needs to be restarted to apply all settings changes when clicking **Apply Changes**. Request for reboot server appears:

DNS		
Type	IP Address	Action
primary	202.96.209.5	Edit
secondary	202.96.209.13	Edit

[Reboot](#)

System needs to be restarted to make the new configurations take effect.

Figure 163 – Reboot information

Reboot – click the button to restart the server and apply the changes.

If there is no other settings needed to be modified, click the **Reboot** button to apply all changes. If there are any other settings need to be changed, continuously to finish and apply all changes and then click **Reboot** button to restart and take effect for all settings.

Network | DHCP

In AP Router mode, the BW1254 can act as a **DHCP Server**. The **DHCP** (Dynamic Host Configuration Protocol) service is supported on the LAN interfaces. This service enables clients on the LAN to request configuration information, such as an IP address, from a server. This service can be viewed in the following table:

DHCP Settings	
Name	Value
Mode	Disabled
Interface Name	br0
	Edit

Figure 164 – DHCP Configuration

Interface Name – select which LAN interface to be configured.[only br0 interface in BW1254]

Select the interface, and then click **Edit** button, a similar screen will appear as below:

DHCP Settings	
Name	Value
Interface Name	br0
Mode	Disabled
<input type="button" value="Save"/> <input type="button" value="Cancel"/>	

Figure 165 – Set DHCP Mode

Mode – DHCP service mode [DHCP server/Disabled]

When **DHCP Server** is selected, a page appears similar to the following:

DHCP Settings	
Name	Value
Interface Name	br0
Mode	DHCP Server
IP Address from	192.168.3.2
IP Address to	192.168.3.254
Netmask	255.255.255.0
Gateway	192.168.3.1
WINS Address	0.0.0.0
lease time(seconds)	300
Domain	
DNS Address	8.8.8.8
DNS Secondary Address	168.95.1.1
<input type="button" value="Save"/> <input type="button" value="Cancel"/>	

Figure 166 – DHCP Server Settings

IP Address from/IP Address to – specify the IP address range supported for the **DHCP** service [mandatory fields]

Netmask – show the subnet mask of current interface

Gateway – show the interface gateway

WINS (Windows Internet Naming Service) Address – specify service IP address if it is available on the network [dots and digits]

Lease Time – specify the IP address renewal in seconds [1-1000000]

Domain – specify DHCP domain name [optional, 1-128 sting]

DNS Address – specify the DNS server's IP address [digits and dots]

DNS Secondary Address – specify the secondary DNS server's IP address [digits and dots]

	The DNS address is same with the setting in the Network DNS menu.
---	--

Change status or leave in the default state if no editing is necessary and click the **Save** button.

DHCP Settings	
Name	Value
Mode	DHCP Server
Interface Name :	br0
IP Address from	192.168.3.2
IP Address to	192.168.3.254
Netmask	255.255.255.0
Gateway	192.168.3.1
WINS Address	0.0.0.0
lease time(seconds)	300
Domain	
DNS Address	8.8.8.8
DNS Secondary Address	168.95.1.1
<input type="button" value="Edit"/>	

Figure 167 – Apply or Discard DHCP server Settings

	The DHCP server settings will be automatically adjusted to match the network interface settings.
---	--

If all of the DHCP settings are correct, click **Apply Changes**, request for reboot server appears:

DHCP Settings	
Name	Value
Mode	DHCP Server
Interface Name :	br0
IP Address from	192.168.3.2
IP Address to	192.168.3.254
Netmask	255.255.255.0
Gateway	192.168.3.1
WINS Address	0.0.0.0
lease time(seconds)	300
Domain	
DNS Address	8.8.8.8
DNS Secondary Address	168.95.1.1
<input type="button" value="Edit"/>	

System needs to be restarted to make the new configurations take effect.

Figure 168 – Reboot information

Reboot – click the button to restart the server and apply the changes.

	If there is no other settings needed to be modified, click the Reboot button to apply all changes. If there are any other settings need to be changed, continuously to finish and apply all changes and then click Reboot button to restart and take effect for all settings.
---	---

Network | DHCP Lease

This page display the DHCP lease information of wireless client which connect to the AP when DHCP server enable.

DHCP Lease			
Host Name	Mac Address	IP Address	Expires in
ggyy-40fbc8fbae	00:13:02:01:14:5a	192.168.2.4	9 d 23 h 59 m 24 s
<input type="button" value="Refresh"/>			

Figure 169 – DHCP lease information

Host Name – the host name of wireless client which associate to the access point.

Mac Address –the MAC address of wireless client which associate to the access point.

IP Address –the IP address of wireless client which associate to the access point.

Expires in – expire time of the wireless client which associate to the access point.

Network | Static Route

Opening the **Static Route Settings** page you will find a list of all pre-configured routes, each consisting of the related interface, the destination IP address, the gateway and the subnet mask.

The **Routing Table** content shows how the router will handle data packets received on an interface with specific destination addresses. By default no static routes are defined on the system:

Static Route					
Interface	Status	Gateway	Target IP Address	Netmask	Action
No routes are defined on system.					
<input type="button" value="Add"/>					

Figure 170 – Static Route Page

A routing rule is defined by the **target** subnet (target IP address and subnet mask), **interface** and/or **gateway** where to route the target traffic. A data packet that is directed to the **target** network is routed to the specified AC interface or to another gateway router. To add a new static route for the system, click the **new** button under the **action** column and specify the following parameters:

Static Route					
Interface	Status	Gateway	Target IP Address	Netmask	Action
br0	enabled	192.168.123.8	192.168.234.0	255.255.255.0	<input type="button" value="Save"/> <input type="button" value="Cancel"/>

Figure 171 – Add New Route

Interface – choose device interface for the route

Status – set new static route status: [enabled/disabled]

Gateway – enter the gateway address for the route. 0.0.0.0 stands for the default gateway of the selected interface [IP address]. The gateway is in the same subnet with selected interface.

Target IP address – enter host IP or network address to be routed to [IP address]

	In this case the class C network(192.168.234.x) is reachable.
---	---

Netmask – enter the target network netmask [dots and digits]

Save – save the new route

Cancel – restore all previous values

Static Route					
Interface	Status	Gateway	Target IP Address	Netmask	Action
br0	enabled	192.168.1.23.8	192.168.234.0	255.255.255.0	Edit Delete
Add					

Figure 172 – Save New Route

	Static route will take effect immediately after click save button.
---	--

Network | Attack Countermeasure

To protect BW1254 from outside attack, anti-attack polices can be set here based on network needs.

Attack Countermeasure					
Item	Status	Max Load	Duration(seconds)	Expire(seconds)	Action
Anti-DOS	Disabled	400 TCP links/s		300	Edit
Flow Control	Disabled	20480 Kbps	60	300	Edit

Figure 173– Attack Countermeasure settings

Anti-DOS

Status – Enable or disable anti-dos policy for BW1254. This policy is for TCP DOS attack.

Max Load – The attack threshold. BW1254 think there is TCP DOS attack and do the countermeasure if one client’s TCP links exceed this threshold.

Expire(seconds) – If one client is considered as DOS attacker, BW1254 kicks it out and doesn’t let it connect again during the time that **Expire** set.

Flow Control

Status – Enable or disable traffic flow control policy for BW1254.

Max Load – The attack throughput threshold.

Duration(seconds) – if traffic exceeds the value of **Max Load** during the whole time that **Duration** set, BW1254 think there is traffic flow attack and do the countermeasure.

Expire(seconds) – If one client is considered as traffic flow attacker, BW1254 kicks it out and doesn’t let it connect again during the time that **Expire** set.

Network | Link Integrity

Specify Link Integrity feature’s settings here. Enable Link Integrity, BW1254 will close wireless connections and kick out all the wireless clients when it detects that its Ethernet network cannot access to the internet.

Link Integrity	
Name	Status
Status	Disabled
Edit	

Figure 174 – Link Integrity settings

Click **Edit** button to set the Link Integrity settings, the similar UI will be appeared as below:

Link Integrity	
Name	Status
Status	Enabled <input type="button" value="v"/>
Target IP1	<input type="text" value="0.0.0.0"/>
Target IP2	<input type="text" value="0.0.0.0"/>
Target IP3	<input type="text" value="0.0.0.0"/>
Target IP4	<input type="text" value="0.0.0.0"/>
Target IP5	<input type="text" value="0.0.0.0"/>
<input type="button" value="Save"/> <input type="button" value="Cancel"/>	

Figure 175 – Edit Link Integrity settings

Status – Enable or disable the feature of Link Integrity

Target IP1 to Target IP5 – IP addresses for BW1254 detecting if its Ethernet interface can access network. The AP will ping every IP address 15 times in sequence. As long as one ping is success it will consider the network is reachable. If ping fail for all IP address specified it will consider Ethernet link fail and all associated wireless client will be logged out. The AP will continue to ping from first IP address. If ping success the wireless will be enable again and client can access the AP.

Save – save the entered values.

Cancel – restore all previous values.

Click **Save**, the similar apply changes UI will be appeared:

Link Integrity	
Name	Status
Status	Enabled
Target IP1	192.168.123.69
Target IP2	192.168.123.1
Target IP3	0.0.0.0
Target IP4	0.0.0.0
Target IP5	0.0.0.0
<input type="button" value="Edit"/>	
<input type="button" value="Apply Changes"/> <input type="button" value="Discard Changes"/>	

Figure 176 –Apply or Discard Link Integrity Settings

Apply Changes – save all changes in the **interface** table at once.

Discard Changes – restore all previous values.

	Maximum 5 target IP can be siecified.
---	---------------------------------------

The BW1254 needs to be restarted to apply all settings changes when clicking **Apply Changes**. Request for reboot server appears:

The screenshot shows a configuration page for 'Link Integrity'. It contains a table with the following data:

Name	Status
Status	Enabled
Target IP1	192.168.123.69
Target IP2	192.168.123.1
Target IP3	0.0.0.0
Target IP4	0.0.0.0
Target IP5	0.0.0.0

Below the table is an 'Edit' button. Further down the page is a 'Reboot' button.

System needs to be restarted to make the new configurations take effect.

Figure 177 – Reboot Server

Reboot – click the button to restart the server and apply the changes.

If there is no other settings needed to be modified, click the **Reboot** button to apply all changes. If there are any other settings need to be changed, continuously to finish and apply all changes and then click **Reboot** button to restart and take effect for all settings.

Network | Tr069 Settings

TR-069 is the Broadband Forum technical specification entitled CPE WAN Management Protocol(CWMP). It defines an application layer protocol for remote management of end-user devices. As a bidirectional SOAP/HTTP-based protocol, it provides the communication between customer-premises equipment(CPE) and Auto Configuration Servers(ACS server). It includes both a safe auto configuration and the control of other CPE management functions within an integrated framework. The protocol addressed the growing number of different internet access devices such as modems,routers,gateways,set-top-boxes,and VOIP-phones for the end users. The TR-069 standard was developed for automatic configuration of these devices with Auto Configuration Servers(ACS).

configure the remote management through TR069 ACS server(eg:BROWAN DMS server)

The screenshot shows a configuration page for 'TR069 Settings'. It contains a table with the following data:

Name	Status
Status	Disabled

Below the table is an 'Edit' button.

Figure 178 – TR-069 settings

Click Edit button and the similar page will be appeared.

TR069 Settings	
Name	Status
Status	Enabled
ACS URL	http://192.168.1.1:9090/dms/tr069
ACS UserName	tr069
ACS UserPassword	tr069passwd
Enable Periodic Inform	Enabled
Periodic Inform Interval	3600
Connection Request UserName	server
Connection Request Password	serverpasswd
<input type="button" value="Save"/> <input type="button" value="Cancel"/>	

Figure 179 – edit TR-069 settings

Status – enable or disable TR-069 setting.[enable/disable]

ACS URL – enter the ACS server URL.

ACS UserName – the user name for AP register to ACS server.

ACS UserPassword – the password for AP register to ACS server.

Enable Periodic Inform – when AP registered to the ACS server, it will automatically send inform message such as S/N,OUI,manufacturer and product name to the ACS server through TR-069 protocol in a periodic time.

Periodic Inform Interval – the inform interval.[in seconds, the value is 720~4294967295]

Connection Request UserName – when the ACS pulling a task to AP/CPE such as firmware upgrade/downgrade, AP need the user name to verify the task sending from ACS server.

Connection Request Password –when the ACS pulling a task to AP/CPE such as firmware upgrade/downgrade, AP need the password to verify the task sending from ACS server.

	Contact the ACS server administrator to get the user name and password for Connection Request UserName and Connection Request Password otherwise the AP will not accept the task pulling by ACS server.
---	---

After enter all field click **save** and **apply changes** button to take effect.

TR069 Settings	
Name	Status
Status	Enabled
ACS URL	http://192.168.1.1:9090/dms/tr069
ACS UserName	tr069
ACS Password	tr069passwd
Enable Periodic Inform	Enable
Periodic Inform Interval	3600
Connection Request UserName	server
Connection Request Password	serverpasswd
<input type="button" value="Edit"/>	
<input type="button" value="Apply Changes"/> <input type="button" value="Discard Changes"/>	

Figure 180 – save TR-069 settings

Reboot – click the button to restart the server and apply the changes.

TR069 Settings	
Name	Status
Status	Enabled
ACS URL	http://192.168.1.1:9090/dms/tr069
ACS UserName	tr069
ACS Password	tr069passwd
Enable Periodic Inform	Enable
Periodic Inform Interval	3600
Connection Request UserName	server
Connection Request Password	serverpasswd

System needs to be restarted to make the new configurations take effect.

Figure 181 – reboot device

	If there is no other settings needed to be modified, click the Reboot button to apply all changes. If there are any other settings need to be changed, continuously to finish and apply all changes and then click Reboot button to restart and take effect for all settings.
--	---

Wireless

Wireless | Basic

Use the **Wireless | Basic** menu to configure wireless settings such as regulatory domain, channel, band, and power, layer 2 isolation. Click the edit button on the setting you need to change:

Basic Wireless Setting	
Radio :	wlan1
Name	Value
Mode	AP
Domain	FCC
Static Channel	11
Band	2.4GHz(11ng HT20)
TxPower	14dBm
RTS Threshold	2347 bytes
Fragment Threshold	2347 bytes
Beacon Interval	100 ms
DCA	Disable
Preamble	auto
Slot Time	auto
Action	<input type="button" value="Edit"/> <input type="button" value="Site Survey"/>

Figure 182 – Basic Wireless Settings with static channel selection

Basic Wireless Setting	
Radio :	wlan1
Name	Value
Mode	AP
Domain	WORLD
Auto Channel	0
Band	2.4GHz(11ng HT20)
TxPower	4dBm
RTS Threshold	2347 bytes
Fragment Threshold	2347 bytes
Beacon Interval	100 ms
DCA	Enable
DCA Threshold	10 mins
DCA optional channel	1,2,3,4,5,6,7,8,9,10,11 channel
Preamble	auto
Slot Time	auto
Action	<input type="button" value="Edit"/> <input type="button" value="Site Survey"/>

Figure 183 – Basic Wireless Settings with auto channel selection(DCA)

Radio – specify which wireless interface of BW1254 is shown. [wlan1(2.4G)/wlan2(5G)]

Mode – show the radio operation mode. (AP mode or Bridge mode)

Domain – show the regulatory domain

Static Channel / Auto Channel – show the channel that the access point will use to transmit and receive information

	<p>If DCA (Dynamic Channel Allocation) is enabled, this will show Auto Channel and its channel number is chosen in auto channel selection.</p> <p>If use static channel selection, this will show Static Channel and its channel number.</p>
---	--

	<p>DCA (Dynamic Channel Allocation) is useful feature to help choose the best channel automatically and reduce interference among many Access Points.</p>
---	---

Band – show the working bands on which the radio is working.

wlan1: four bands listed: 2.4GHz(11g only) , 2.4GHz(11n HT20) , 2.4GHz(11n HT20/40plus), 2.4GHz(11n HT20/40minus)

wlan2: four bands listed: 5GHz(11a), 5GHz(11n HT20) , 5GHz(11n HT20/40plus), 5GHz(11n HT20/40minus) .

	<p>By default, the HT20/40 is recommended.</p>
--	--

Tx Power – show the BW1254 transmission output power (without antenna gain) in dBm.

RTS Threshold –the AP sends Request to Send(RTS) frames to a particular receiving station and negotiates the sending of a data frame. After receiving an RTS, the wireless station responds with a Clear to Send(CTS) frame to acknowledge the right to begin transmission. The default value is 2347.[recommend].

Fragment Threshold –It specifies the maximum size for a packet before data is fragmented into multiple packets. If you experience a high packet error rate, you may slightly increase the fragmentation threshold. Setting the fragmentation threshold too low may result in poor network performance. Only minor modifications of this value are recommended. The default value is 2347.[recommend]

Beacon Interval –the Beacon Interval value indicates the frequency interval of the beacon. A beacon is a packet broadcast by the AP to synchronize the wireless network.

DCA – Enable or Disable DCA service. DCA can help to choose the best working channel automatically. And static channel selection will be forbidden if DCA is enabled.

DCA(Dynamic Channel Allocation) solution automatically select the optimal operational frequency channel when power up and periodically monitors the environment and adjusts for the best operational frequency channel.

DCA threshold – specify the value (in minutes) of DCA threshold. This threshold is been used to judge if there is no wireless users connected during this time. And if yes, BW1254 will monitor the environment and adjust channel for the best operational one.

	<p>If wireless network environment is stable which means auto channel selection needn't do frequently, set a big value for DCA threshold to gain a stable wireless users' connection.</p> <p>If wireless network environment changes continually, frequent auto channel selection is needed. So set a relative small value for DCA threshold to let channel change based on wireless environment.</p>
---	---

	Wireless users' will be kicked off when DCA is processing (new operational frequency channel takes effect).
---	---

DCA optional channel – show the channels only in which auto channel selection (DCA) will be processed to reduce interference.

	Only when DCA is enabled, DCA threshold and DCA optional channel will be shown.
---	---

Preamble – if your wireless device supports the short preamble and you are having trouble getting it to communicate with other 802.11b devices, make sure that it is set to use the long preamble.

Auto: using long preamble when there are clients not supporting short preamble connected , otherwise using short preamble. The default is Auto.[recommend]

Short: always using short preamble.

Long: always using long preamble.

Slot Time – show the slot time policy when working in 2.4GHz band.

Auto: using long slot time when there are clients not supporting short slot time connected in, otherwise using short slot time. The Switching between long and short slot time is automatic.

Short: always using short slot time.

Long: always using long slot time.

	To Maximize the compatibility with some 11b clients, set both Preamble and Slot Time to long.
--	---

Edit – edit the wireless basic settings

To change basic wireless setting properties click the **Edit** button in the **Action** column. The **status** can be changed now:

Basic Wireless Setting	
Name	Value
Radio Name	wlan1
Mode	AP
Domain	FCC
Channel	1
Band	2.4GHz(11ng HT20)
TxPower	14 dBm
RTS Threshold	2347 bytes [0..2347]
Fragment Threshold	2347 bytes [0..2347]
Beacon Interval	100 ms [1..65536]
DCA	<input type="checkbox"/> Enable
DCA Threshold	10 mins
DCA optional channel	<input checked="" type="checkbox"/> 1 <input checked="" type="checkbox"/> 2 <input checked="" type="checkbox"/> 3 <input checked="" type="checkbox"/> 4 <input checked="" type="checkbox"/> 5 <input checked="" type="checkbox"/> 6 <input checked="" type="checkbox"/> 7 <input checked="" type="checkbox"/> 8 <input checked="" type="checkbox"/> 9 <input checked="" type="checkbox"/> 10 <input checked="" type="checkbox"/> 11 <input checked="" type="checkbox"/> all
Preamble	auto
Slot Time	auto
<input type="button" value="Save"/> <input type="button" value="Cancel"/>	

Figure 184 – Edit Basic Wireless Settings with static channel selection

Basic Wireless Setting	
Name	Value
Radio Name	wlan1
Mode	AP
Domain	FCC
Channel	1
Band	2.4GHz(11ng HT20)
TxPower	14 dBm
RTS Threshold	2347 bytes [0..2347]
Fragment Threshold	2347 bytes [0..2347]
Beacon Interval	100 ms [1..65536]
DCA	<input checked="" type="checkbox"/> Enable
DCA Threshold	10 mins
DCA optional channel	<input checked="" type="checkbox"/> 1 <input checked="" type="checkbox"/> 2 <input checked="" type="checkbox"/> 3 <input checked="" type="checkbox"/> 4 <input checked="" type="checkbox"/> 5 <input checked="" type="checkbox"/> 6 <input checked="" type="checkbox"/> 7 <input checked="" type="checkbox"/> 8 <input checked="" type="checkbox"/> 9 <input checked="" type="checkbox"/> 10 <input checked="" type="checkbox"/> 11 <input checked="" type="checkbox"/> all
Preamble	auto
Slot Time	auto
<input type="button" value="Save"/> <input type="button" value="Cancel"/>	

Figure 185 – Edit Basic Wireless Settings with DCA enabled

Radio Name – specify wireless interface of BW1254 is shown

Mode – configure the radio operation mode.

	In AP-Router mode, the radio only support AP mode for wireless client connection.
---	---

Domain – select the regulatory domain.

Channel – select the channel that the access point will use to transmit and receive information. If one channel is defined, it acts as default channel. Channels list will vary depending on selected regulatory domain and selected band. If you wish to operate more than one access point in overlapping coverage areas, we recommend at least four channels interval between the chosen channels. For example, for three Access Points in close proximity choose channels 1, 6 and 11 for 11b/g or channels 36, 40 and 64 for 11a.

Band – show the working bands on which the radio is working.

wlan1: four bands listed: 2.4GHz(11g only) , 2.4GHz(11n HT20) , 2.4GHz(11n HT20/40plus), 2.4GHz(11n HT20/40minus)

wlan2: four bands listed: 5GHz(11a), 5GHz(11n HT20) , 5GHz(11n HT20/40plus), 5GHz(11n HT20/40minus) .

TxPower – the BW1254 transmission output power in dBm.

	The value of the TxPower varies according to channel and regulatory domain.
---	---

RTS Threshold – the AP sends Request to Send(RTS) frames to a particular receiving station and negotiates the sending of a data frame. After receiving an RTS, the wireless station responds with a Clear to Send(CTS) frame to acknowledge the right to begin transmission. The default value is 2347.[recommend]

Fragment Threshold – It specifies the maximum size for a packet before data is fragmented into multiple packets. If you experience a high packet error rate, you may slightly increase the fragmentation threshold. Setting the fragmentation threshold too low may result in poor network performance. Only minor modifications of this value are recommended. The default value is 2347.[recommend]

Beacon Interval – the Beacon Interval value indicates the frequency interval of the beacon. A beacon is a packet broadcast by the AP to synchronize the wireless network.

DCA – Enable or Disable DCA service. DCA can help to choose the best working channel automatically. And static channel selection will be forbidden if DCA is enabled.

DCA(Dynamic Channel Allocation) solution automatically select the optimal operational frequency channel when power up and periodically monitors the environment and adjusts for the best operational frequency channel.

DCA threshold – specify the value (in minutes) of DCA threshold. This threshold is been used to judge if there is no wireless users connected during this time. And if yes, BW1254 will monitor the environment and adjust channel for the best operational one.

	<p>If wireless network environment is stable which means auto channel selection needn't do frequently, set a big value for DCA threshold to gain a stable wireless users' connection.</p> <p>If wireless network environment changes continually, frequent auto channel selection is needed. So set a relative small value for DCA threshold to let channel change based on wireless environment.</p>
---	---

	<p>Wireless users' will be kicked off when DCA is processing (new operational frequency channel takes effect).</p>
--	--

DCA optional channel – specify the channels only in which auto channel selection (DCA) will choose for reducing interference reference.

	<p>Only when DCA is enabled, DCA threshold and DCA optional channel will be shown.</p>
---	--

Preamble – if your wireless device supports the short preamble and you are having trouble getting it to communicate with other 802.11b devices, make sure that it is set to use the long preamble.

Auto: using long preamble when there are clients not supporting short preamble connected , otherwise using short preamble. The default is Auto.[recommend]

Short: always using short preamble.

Long: always using long preamble.

Slot Time – specify the slot time policy when working in 2.4GHz band.

Auto: using long slot time when there are clients not supporting short slot time connection, otherwise using short slot time. The default is Auto.[recommend]

Short: always using short slot time.

Long: always using long slot time.

	<p>To Maximize the compatibility with some 11b clients, set both Preamble and Slot Time to long.</p>
---	--

Change status or leave in the default state if no editing is necessary and click the **Save** button.

Basic Wireless Setting	
Radio :	wlan1
Name	Value
Mode	AP
Domain	FCC
Static Channel	1
Band	2.4GHz(Mixed 11g)
Total Output Power (EIRP)	14dBm
Antenna Gain	2dBi
RTS Threshold	2347 bytes
Preamble	auto
Slot Time	auto
Action	<input type="button" value="Edit"/> <input type="button" value="Site Survey"/>

Figure 186 – Apply or Discard Basic Wireless Settings with Static Channel selection

Basic Wireless Setting	
Radio :	wlan1
Name	Value
Mode	AP
Domain	FCC
Auto Channel	auto
Band	2.4GHz(Mixed 11g)
Total Output Power (EIRP)	14dBm
Antenna Gain	2dBi
RTS Threshold	2347 bytes
DCA Threshold	10 mins
DCA optional channel	4,5,7 channel
Preamble	auto
Slot Time	auto
Action	<input type="button" value="Edit"/> <input type="button" value="Site Survey"/>

Figure 187 – Apply or Discard Basic Wireless Settings with DCA enabled

For such change of settings, the BW1254 needs to be restarted to apply all settings changes when clicking **Apply Changes**. Request for reboot server appears:

Basic Wireless Setting	
Radio :	wlan1
Name	Value
Mode	AP
Domain	FCC
Auto Channel	1
Band	2.4GHz(Mixed 11g)
Total Output Power (EIRP)	14dBm
Antenna Gain	2dBi
RTS Threshold	2347 bytes
DCA Threshold	10 mins
DCA optional channel	4,5,7 channel
Preamble	auto
Slot Time	auto
Action	<input type="button" value="Edit"/> <input type="button" value="Site Survey"/>

System needs to be restarted to make the new configurations take effect.

Figure 188 – Reboot Server

Reboot – click the button to restart the server and apply the changes.

	If there is no other settings needed to be modified, click the Reboot button to apply all changes. If there are any other settings need to be changed, continuously to finish and apply all changes and then click Reboot button to restart and take effect for all settings.
---	---

Wireless | Advanced

BW1254 supports **Multiple BSSID (MBSSID)** function. You can configure up to 16 BSSIDs on BW1254 and assign different configuration settings to each BSSID. For wireless users, they can think BW1254 as single AP with multi service supporting, including different security policy, different VLAN ID, different authentication etc. All the BSSIDs are active at the same time that means client devices can associate to the access point for specific service. Use the **Wireless | Advanced** menu to configure properties related to Multiple BSSID, including configure SSID, Hidden SSID, VLAN, and Security for each SSID.

	Each BSSID can have its own SSID. In this case, Multiple BSSID is the same with Multiple ESSID. Wireless users can think BW1254 as multiple virtual APs, each supporting different service, and connects one SSID for the special services.
---	---

AP Mode

If you configure AP mode, the page will be shown as below in **Wireless | Advanced** menu.

Advance Wireless Setting					
Radio: wlan1		AP Mode			
Interface	SSID	Hidden	Security	Current Connect #	Action
wlan1_0	BW1254-11ng-ggynn	Disabled	Disabled	1	Detail Edit Delete
wlan1_1	BW1254-11ng-gggy	Disabled	WPA2-PSK	0	Detail Edit Delete
					New
Refresh					

Figure 189 – Advanced Wireless Setting (AP Mode)

Radio – specify wireless interface to be configured. [wlan1(2.4G/wlan2(5G)]

Mode – show the current operation mode of this radio (AP or Bridge)

Interface – display the interface which corresponding to the SSID. Each Interface maps to a BSSID

SSID – SSID name for wireless client searching and associating.

Hidden – show the status of Hidden SSID feature[disable/enable]

Security – show which security policy is used for this **MBSSID** entry

Current Connect # – show the number of current wireless clients associate to this MBSSID

New – create a new **MBSSID** entry

Detail – show the detail information of this **MBSSID** entry

Edit – edit the selected **MBSSID** entry you want to configure

Delete – delete the selected **MBSSID** entry. When in AP mode, you can not delete the last entry

Refresh – rescan the WEB page to get newer information

Clicking **New** or **Edit** button to configure the SSID parameters. Describe as below:

Advance Wireless Setting			
Radio	wlan1		
Interface	wlan1_0		
Mode	AP		
SSID	BW1254-11ng-gggy (Printable ASCII Characters)		
	<input type="checkbox"/> Need Hidden SSID		
	<input checked="" type="checkbox"/> SSID status		
	<input type="checkbox"/> Disable 11b		
	<input type="checkbox"/> Only 11n		
	<input type="checkbox"/> Disassociation low MCS		
Max Station Number	<input type="checkbox"/> Enable	<input type="text" value=""/>	(1~127)
Layer 2 Isolation	<input type="checkbox"/> Enable Intra-BSS Layer 2 Isolation		
	(Inter-BSS Layer 2 Isolation can be configed in Wireless -> Layer 2 Isolation page.)		
Bandwidth			
	<input type="checkbox"/> Enable bandwidth		
		Download bandwidth	<input type="text" value=""/> (Mbps)
		Upload bandwidth	<input type="text" value=""/> (Mbps)

Figure 190 – BSSID Setting -1

Radio – show the wireless interface is being configured.

Interface – show the current sub-interface.

Mode – show the operation mode of current radio.

SSID – a unique ID for your wireless network. It is case sensitive and must not exceed 32 characters. The SSID is important for clients when connecting to the access point.

Need Hidden SSID – when enabled, the SSID of this Interface is invisible in the networks list while scanning the available networks for wireless client (SSID is not broadcasted with its Beacons). When disabled, the AP’s SSID is visible in the available network list [enabled/disabled]. By default the Hidden SSID is disabled

SSID status – activated or deactivated the SSID. The default is activated SSID[check box].

Disable 11b – enable/disable 11b client connection. [check box] to enable the function.



Only 11n – only 802.11n client can connected to the SSID.

Disassociation low MCS – low MCS client won’t associate to the AP. [check box] to enable it.

Max Station Number – define maximum number of associated wireless client to this SSID. By default the number is maximum 127 client can be associated to the AP without check box. Or check box to enable limited client.[1~127]

Layer 2 Isolation – Specify the layer 2 isolation policy.

Enable Intra-BSS Layer 2 Isolation – when enabled, the clients that connect in this same BSS can’t visit each other. By default the intra-BSS layer 2 isolation is disabled.

	Intra-BSS layer2 isolation – which enable or disable client isolation under same SSID. Inter-BSS layer2 isolation – which enable or disable client isolation between different SSID.
	Please go to Wireless Layer 2 Isolation(Inter-BSS) menu to configure inter-BSS layer 2 Isolation. Full layer 2 isolation need to set both intra-BSS and inter-BSS layer 2 isolation in the AP mode.

Bandwidth – enable/disable upstream/downstream bandwidth control per SSID.

Download bandwidth – specified the maximum downstream in Mbps controlled by the SSID.

Upload bandwidth – specify the maximum upstream in Mbps controlled by the SSID.

VLAN			
	<input type="checkbox"/> Enable VLAN		
		VLAN ID	<input type="text"/> (1~4094)
		802.1p Tag	<input type="text" value="Best Effort(0)"/> (Class of Service)
Interface Priority			
	<input type="text" value="Best Effort(0)"/> (Class of Service)		
WMM	<input checked="" type="checkbox"/> Enable WMM		
ESS in Tunnel	<input type="radio"/> Enabled		
		Remote Server IP	<input type="text"/>
	<input checked="" type="radio"/> Disabled		

Figure 191 – Multiple BSSID Setting -2

VLAN – specify VLAN policy

Enable VLAN – when enabled, the outgoing packets from this SSID device will be tagged with VLAN ID and 802.1p tag.

VLAN ID – configure VLAN ID for each Multiple SSID devices. Valid numbers are from 1 to 4094

802.1p Tag – configure 802.1p Tag for remote APC’s or Router’s QoS uses. Eight levels selective, Background(1), Spare(2), Best Effort(0), Excellent Effort(3), Controlled Load(4), Interactive Video(5), Interactive Voice(6), Network Contro(7)

	VLAN ID and 802.1p tag must cooperate with remote Router or APC.
---	--

Interface priority – specify the traffic priority for this SSID interface, which is implemented according to 802.11e EDCA and makes sure the wireless downlink QoS. This priority is based on SSID, which means different BSSID can have different traffic priority and the traffic of the same SSID has the same priority

	This traffic priority only makes sure the priority of downlink (from AP to wireless client). 8 levels priorities are supplied. 1, 2, 0, 3, 4, 5, 6, 7 is from lowest priority to highest priority. And if no special QoS is needed, leave priority to default (0). 0 means Best Effort priority.
---	---

WMM –BW1254 support WMM wireless clients and implement WMM QoS with the WMM clients.
[enable]

ESS in Tunnel – Settings for ESS in tunnel. When enabled, BW1254 setup tunnel with remote AC for passing through layer3 network.

Remote Server IP – IP address of remote AC product that setup tunnel with BW1254

Security			
<input type="radio"/> WEP(Wired Equivalent Privacy)			
	WEP KeyIndex	<input type="text" value="1"/>	
<input type="radio"/> 802.1x			
	RADIUS Server Profile	<input type="text" value="DEFAULT"/>	
	Dynamic WEP Encryption	<input type="radio"/> Disabled <input type="radio"/> 64 bits <input type="radio"/> 128 bits	
		<input type="checkbox"/> Pass Through	
<input type="radio"/> WPA			
	RADIUS Server Profile	<input type="text" value="DEFAULT"/>	
	Algorithm	<input type="text" value="TKIP"/>	
	Group Key Rekey Interval	<input type="text"/> Minutes	
<input type="radio"/> WPA2			
	RADIUS Server Profile	<input type="text" value="DEFAULT"/>	
	Algorithm	<input type="text" value="TKIP"/>	
	Group Key Rekey Interval	<input type="text"/> Minutes	
<input type="radio"/> WPA2 MIXED			
	RADIUS Server Profile	<input type="text" value="DEFAULT"/>	
	Algorithm	TKIP/AES	
	Group Key Rekey Interval	<input type="text"/> Minutes	

Figure 192 – Multiple BSSID Setting – 3

Security – specify the security policy

WEP – Wired Equivalent Privacy(WEP) is a security algorithm for IEEE 802.11 wireless networks.

WEP Key Index – select the default key Index to make it the Default key and encrypt the data before being transmitted. All stations, including this MSSID Entry, always transmit data encrypted using this Default Key. The key number (1, 2, 3, 4) is also transmitted. The receiving station will use the key number to determine which key to use for decryption. If the key value does not match with the transmitting station, the decryption will fail. The key value is set in **Wireless | WEP** web page

802.1x – when selected, the MSSID entry will be configured as an 802.1x authenticator. It supports multiple authentication types based on EAP (Extensible Authentication Protocol) like EAP-TLS, EAP-TTLS, EAP-PEAP, EAP-SIM. The privacy will be configured as dynamic WEP

RADIUS Server Profile – select your RADIUS server profile

	Please go to Network RADIUS Server menu to configure your RADIUS server profile or add a new profile, and please refer to Network RADIUS Server for its configuration.
---	--

Dynamic WEP Encryption – select whether using the dynamic 64-bits encryption, 128-bits encryption or without encryption

Pass Through – when enabled, client can access network whether it passed 802.1x authentication or not

	Only when 802.1x enabled and dynamic key disabled this option can be enabled.
---	---

WPA – Wi-Fi Protected Access, When selected, the encrypt method will be WPA with RADIUS Sever

WPA2 – when selected, the security policy will be WPA2 with RADIUS server. In this mode, WPA client is not permitted to connect

WPA2 MIXED – when selected, WPA2 client and WPA client are all permitted to connect

RADIUS Server Profile – select your RADIUS server profile

	Please go to Network RADIUS Server menu to configure your RADIUS server profile or add a new profile, and please refer to Network RADIUS Server for its configuration.
---	--

Algorithm – choose WPA algorithm (TKIP, AES)

Group Key Rekey Interval – specify amount of minutes and WPA automatically will generate a new Group Key



<input type="radio"/> WPA-PSK		
	Use Pre-Shared Key	<input type="text"/>
	Algorithm	TKIP 
	Group Key Rekey Interval	<input type="text"/> Minutes
<input type="radio"/> WPA2-PSK		
	Use Pre-Shared Key	<input type="text"/>
	Algorithm	TKIP 
	Group Key Rekey Interval	<input type="text"/> Minutes
<input type="radio"/> WPA2-PSK MIXED		
	Use Pre-Shared Key	<input type="text"/>
	Algorithm	TKIP/AES
	Group Key Rekey Interval	<input type="text"/> Minutes
<input type="radio"/> MAC Auth		
	RADIUS Server Profile	DEFAULT 

Figure 193 – Multiple BSSID Setting – 4

WPA-PSK – when selected, the encrypt method will be WPA without RADIUS server

WPA2-PSK – when selected, the security policy will be WPA2 PSK without RADIUS server. In this mode, only WPA2 PSK client can connect with AP and WPA PSK client is not permitted to connect

WPA2-PSK MIXED – when selected, WPA2 PSK and WPA PSK clients are all permitted to connect with AP

Use Pre-Shared Key –specify more than 8 characters and less than 64 characters for WPA with pre-shared key encryption

Algorithm – choose WPA algorithm (TKIP, AES)

Group Key Rekey Interval –specify amount of minutes and WPA automatically will generate a new Group Key

MAC Auth – when selected, the MAC address of wireless client will be passed to RADIUS server for PAP authentication when it connects with BW1254. The MAC address of wireless client acts as username and password

RADIUS Server Profile – select the default radius server name

<input type="radio"/> WAPI	AAA Server Profile:	DEFAULT
WAPI certificate has not been Uploaded. Click here to upload certificate.		
<input type="radio"/> WAPI-PSK	Encode:	HEX
	Use Pre-Shared Key:	<input type="text"/>
<input type="radio"/> Disabled		
<input type="button" value="Save"/> <input type="button" value="Cancel"/>		

Figure 194 – Multiple BSSID Setting – 5

WAPI – WLAN Authentication and Privacy Infrastructure (WAPI) is a Chinese National Standard for wireless LAN(GB15629.11-2003).(Only for China)

It needs to upload WAPI certificate.

AAA Server Profile – select your RADIUS server profile

WAPI-PSK –the encrypt method will be WAPI without RADIUS server

Encode – Pre-shared key encode.[HEX/ASCII]

Use Pre-Shared key – specify more than 8 characters and less than 64 characters for WPA with pre-shared key encryption

Disabled – when selected, you don't select any security policy

Change status or leave in the default state if no editing is necessary and click the **Save** button.

Advance Wireless Setting	
Radio	wlan1
Interface	wlan1_0
Mode	AP
SSID	SSID
Hidden SSID	Disabled
Intra-BSS Layer 2 Isolation	Disabled
Use VLAN	Disabled
Interface Priority	Best Effort(0) (Class of Service)
WMM	Enabled
ESS in Tunnel	Disabled
Security	Disabled
Current Connected Number	0
<input type="button" value="Refresh"/> <input type="button" value="Return"/>	
<input type="button" value="Apply Changes"/> <input type="button" value="Discard Changes"/>	

Figure 195 –Apply or Discard the advanced Settings in AP mode

For each change of settings, the BW1254 needs to be restarted to apply all settings changes when clicking **Apply Changes**. Request for reboot server appears:

Advance Wireless Setting	
Radio	wlan1
Interface	wlan1_0
Mode	AP
SSID	SSID
Hidden SSID	Disabled
Intra-BSS Layer 2 Isolation	Disabled
Use VLAN	Disabled
Interface Priority	Best Effort(0) (Class of Service)
WMM	Enabled
ESS in Tunnel	Disabled
Security	Disabled
Current Connected Number	0

System needs to be restarted to make the new configurations take effect.

Figure 196 – Reboot information

Reboot – click the button to restart the server and apply the changes.

	<p>If there is no other settings needed to be modified, click the Reboot button to apply all changes. If there are any other settings need to be changed, continuously to finish and apply all changes and then click Reboot button to restart and take effect for all settings.</p>
--	--

Wireless | WEP

Use the **Wireless | WEP** menu to configure static WEP settings.

	<p>This menu only set static WEP key value related with 4 key indexes. Enable or Disable static WEP is in the Wireless Advance menu.</p>
---	---

WEP Configuration		
Radio	wlan1	
Index	Key	Action
Key 1	*****	<input type="button" value="Edit"/>
Key 2	*****	<input type="button" value="Edit"/>
Key 3	*****	<input type="button" value="Edit"/>
Key 4	*****	<input type="button" value="Edit"/>

The network password needs to be 64bits or 128bits depending on your network configuration. This can be entered as 5 or 13 ascii characters or 10 or 26 hexadecimal characters.

Figure 197 – WEP Settings

Radio –show the wireless interface.

Click **Edit** to edit the existing **wepkey1** to **wepkey4**.

	By default, four WEP keys are all set to “aaaaa” (ascii characters) or “6161616161” (hexadecimal characters). They can be modified according to requirement.
---	--

WEP Configuration

Radio	<input type="text" value="wlan1"/>	
Index	Key	Action
Key 1	<input type="text"/>	<input type="button" value="Save"/> <input type="button" value="Cancel"/>
Key 2	*****	<input type="button" value="Edit"/>
Key 3	*****	<input type="button" value="Edit"/>
Key 4	*****	<input type="button" value="Edit"/>

The network password needs to be 64bits or 128bits depending on your network configuration. This can be entered as 5 or 13 ascii characters or 10 or 26 hexadecimal characters.

Figure 198 – Edit WEP Key

Change status or leave in the default state if no editing is necessary and click the **Save** button.

WEP Configuration

Radio	<input type="text" value="wlan1"/>	
Index	Key	Action
Key 1	*****	<input type="button" value="Edit"/>
Key 2	*****	<input type="button" value="Edit"/>
Key 3	*****	<input type="button" value="Edit"/>
Key 4	*****	<input type="button" value="Edit"/>

The network password needs to be 64bits or 128bits depending on your network configuration. This can be entered as 5 or 13 ascii characters or 10 or 26 hexadecimal characters.

Figure 199 –Apply or Discard WEP Configuration

For each change of settings, the BW1254 needs to be restarted to apply all settings changes when clicking **Apply Changes**. Request for reboot server appears:

WEP Configuration		
Radio	wlan1	
Index	Key	Action
Key 1	*****	Edit
Key 2	*****	Edit
Key 3	*****	Edit
Key 4	*****	Edit
The network password needs to be 64bits or 128bits depending on your network configuration. This can be entered as 5 or 13 ascii characters or 10 or 26 hexadecimal characters.		

[Reboot](#)

System needs to be restarted to make the new configurations take effect.

Figure 200 – Reboot information

Reboot – click the button to restart the server and apply the changes

	If there is no other settings needed to be modified, click the Reboot button to apply all changes. If there are any other settings need to be changed, continuously to finish and apply all changes and then click Reboot button to restart and take effect for all settings.
---	---

Wireless | MAC ACL

Use the **MAC ACL** service to control the default access to the wireless interface of the BW1254 or define special access rules for mobile clients. Configure the ACL using the **Wireless | MAC ACL** menu:

MAC ACL Configuration		
Radio	wlan1	
Policy	Allow	Edit
MAC List	Action	
00:90:4B:C9:42:55	Delete	
Add		

Figure 201 – MAC ACL Service

Radio – show the wireless interface.

	The wireless interface which is Bridge mode hasn't MAC ACL settings.
---	--

Policy – click the **edit** button to choose Allow, Deny or disable the access control service on device. By default the ACL service is disabled and all wireless clients connecting to the BW1254 are allowed (no ACL rules are applied to the wireless clients)

Select **Allow** means only the wireless clients whose MAC are listed in the **MAC List** would be permitted to access this AP. Other wireless client cannot access this AP.

Select **Deny** means only the wireless clients whose MAC are listed in the **MAC List** would be prevented from accessing. Other wireless clients can access this AP.

Select **Disabled** means no ACL service.

MAC ACL Configuration		
Radio	wlan1	
Policy	Allow	Save Cancel
MAC List	<ul style="list-style-type: none"> Allow <li style="background-color: #e0f0ff;">Deny Disabled 	Action
00:90:4B:C9:42:55		Delete
Add		

Figure 202 – MAC ACL settings

You must create **MAC List** to work with **Policy** setting. The access control list is based on the network device’s MAC address. In the MAC ACL Configuration table, you only need to specify the MAC address of wireless client. Click the **Add** button to create a new MAC entry:

MAC ACL Configuration		
Radio	wlan1	
Policy	Allow	Edit
MAC List		Action
00:90:4B:C9:42:55		Delete
<input type="text"/>	Example: 00:90:4B:00:11:22	Save Cancel

Figure 203 – Add MAC entry

MAC Address – enter the physical address of the network device you need to (MAC address). The format is a list of colon separated hexadecimal numbers (for example: 00:90:4B:00:11:22)

Save – click the button to save the new MAC entry

MAC ACL Configuration		
Radio	wlan1	
Policy	Allow	Edit
MAC List		Action
00:90:4B:C9:42:55		Delete
Add		

Apply Changes	Discard Changes
---------------	-----------------

Figure 204 – Apply or Discard MAC ACL Configuration Changes

Apply Changes – to save all changes made in the **interface** table at once

Discard Changes – restore all previous values

For such change of settings, the BW1254 needs to be restarted to apply all settings changes when clicking **Apply Changes**. Request for reboot server appears:

MAC ACL Configuration		
Radio	wlan1	
Policy	Allow	<input type="button" value="Edit"/>
MAC List		Action
00:90:4B:C9:42:55		<input type="button" value="Delete"/>
<input type="button" value="Add"/>		

System needs to be restarted to make the new configurations take effect.

Figure 205 – Reboot Server

Reboot – click the button to restart the server and apply the changes

	If there is no other settings needed to be modified, click the Reboot button to apply all changes. If there are any other settings need to be changed, continuously to finish and apply all changes and then click Reboot button to restart and take effect for all settings.
---	---

User

User | Users

The **User | Users** menu shows the statistics of connected users. The user can be monitored and managed such as drop from the network.

Users								
Index	User	Interface	User IP	Authed	Wireless Auth	Time Length	Idle Time	Action
01.	00:0c:41:16:97:aa	wlan1_0	192.168.120.62	No	NONE	00:26:53	00:00:25	Details Kickoff

[Refresh](#)

Figure 206 – User’s statistics

User – show the connected client’s MAC address

Interface – show which BSS the client connected to

User IP – IP address, from which the user’s connection is established [digits and dots]

Authed – indicate this client is authenticated or not

WEB Auth/L2 Auth – show the authentication method which user uses to connect

Time Length – session duration since the user login [hh:mm:ss]

Idle Time – amount of user inactivity time [hh:mm:ss]

Action – view the statistics or kickoff the user.

Detail – click on user details to get more information about the client:

Kickoff – logout the user.

Users		
Description	Value	Action
user	rock	
interface	wlan1_0	
user IP	192.168.3.3	
MAC address	00904B238D42	
WEB Auth / L2 Auth	UAM / NONE	
WISP		
session id	00000828A9B1	
time length	02:12:21	
remaining time length	4 days 18:27:39	
idle time	00:00:21	
idle timeout	00:01:00	
input bytes	2 MB	
output bytes	961 KB	
remaining input bytes	-	
remaining output bytes	-	
remaining total bytes	-	
bandwidth downstream	512 Kbps	
bandwidth upstream	512 Kbps	
		Back Kickoff
		Refresh

Figure 207 – User's Details

User – login user name

interface – the interface that wireless client associated.

User IP – the IP address of wireless client.

MAC address – hardware address of the network device from which the user is connected

WEB Auth/L2 Auth – show web authentication and layer2 authentication status, layer2 authentication include all supported EAP type of 802.1x auth and MAC auth

WISP – WISP domain name where the user belongs

Session ID – the unique user's session ID number. This can be used for troubleshooting purposes

Remaining Time Length – remaining user's session time [hh:mm:ss]. Session time for user is defined in the RADIUS Server

Idle time – specify current idle time.

Idle Timeout – specify the time of user idle timeout [hh:mm:ss]. When reach the time, the user will be logged out automatically.

Input Bytes – amount of data in bytes which the user network device has received [Bytes]

Output Bytes – amount of data in bytes, transmitted by the user network device [Bytes]

Remaining Input/Output Bytes – user session remaining input/output bytes. WISPr Operator can define the user session in bytes. Remaining bytes is received from RADIUS [Bytes/unlimited]

Remaining Total Bytes –user session remaining total bytes. WISPr Operator can define the user session in bytes. Remaining bytes is received from RADIUS [Bytes/unlimited]

Bandwidth Downstream/Upstream – user upstream and downstream bandwidth [in bps]

Back – returns to connect client’s statistics list

Kickoff – click this button to logout the user from access point.

Refresh – click the button to refresh users’ statistics

User | Station Supervision

The **Station Supervision** function is used to monitor the connected host station availability. This monitoring is performed with ping. If the specified number of ping failures is reached (**failure count**), the user is logged out from the BW1254.

Station Supervision		
Interval	Failure Count	Action
20	3	<input type="button" value="Edit"/>

Figure 208 – Station Supervision

To adjust the ping interval/failure count, click the **Edit** button.

Station Supervision		
Interval	Failure Count	Action
<input type="text" value="20"/>	<input type="text" value="3"/>	<input type="button" value="Save"/> <input type="button" value="Cancel"/>

Figure 209 – Edit Station Supervision

Interval – define interval of sending ping to host [in seconds]

Failure Count – failure count value after which the user is logged out from the system

Save – save station supervision settings

Cancel – cancel changes

Change status or leave in the default state if no editing is necessary and click the **Save** button.

Station Supervision		
Interval	Failure Count	Action
20	3	Edit

[Apply Changes](#) [Discard Changes](#)

Figure 210 –Apply or Discard Station Supervision Changes

Apply Changes – to save all changes at once

Discard Changes – restore all previous values

For such change of settings, the BW1254 needs to be restarted to apply all settings changes when clicking **Apply Changes**. Request for reboot server appears:

Station Supervision		
Interval	Failure Count	Action
20	3	Edit

[Reboot](#)

System needs to be restarted to make the new configurations take effect.

Figure 211 – Reboot Server

Reboot – click the button to restart the server and apply the changes

If there is no other settings needed to be modified, click the **Reboot** button to apply all changes. If there are any other settings need to be changed, continuously to finish and apply all changes and then click **Reboot** button to restart and take effect for all settings.

User | User ACL

User ACL provide high flexibility for administrator to define the rules for BW1254 to filter the packets which will forward or masquerade by it.

User ACL											
Index	Policy	Protocol	In Interfaces	Out Interfaces	Source IP	Source Netmask	Source Port	Dest IP	Dest Netmask	Dest Port	Action
No ACLs are defined on system.											
Add											

Figure 212 – User ACL

To add a new rule, just click the **Add** button.

User ACL											
Index	Policy	Protocol	In Interfaces	Out Interfaces	Source IP	Source Netmask	Source Port	Dest IP	Dest Netmask	Dest Port	Action
1	DROP	tcp	any	any	-	-	-	-	-	-	Continue

Figure 213 – Create a new rule (first step)

First step select the rule policy [drop/accept/masquerade] to deal with packet and the packet type [all/TCP/UDP/ICMP] and which interface the rule will act on.

Policy – define the policy of client through the access point. It supports three types of rules: DROP, ACCEPT and MASQUERADE. The appropriate policy defines what to do if the data packet received matches the rule

Protocol – network protocol which the rule affects. Can be specified as one of “TCP/UDP/ICMP” or “any”

In Interface – the data packet to the current interface must obey the rule

Out Interface – the data packet from the current interface must obey the rule

User ACL												
Index	Policy	Protocol	In Interfaces	Out Interfaces	Source IP	Source Netmask	Source Port	Dest IP	Dest Netmask	Dest Port	Action	
1	DROP	tcp	any	any	Special IP	-	-	Special IP	-	-	Continue Cancel	

Figure 214 – Create a new rule (second step)

Second step select the type of source IP and destination IP [special IP/any IP].

User ACL												
Index	Policy	Protocol	In Interfaces	Out Interfaces	Source IP	Source Netmask	Source Port	Dest IP	Dest Netmask	Dest Port	Action	
1	DROP	tcp	any	any	special	-	Special Port	special	-	Special Port	Continue Cancel	

Figure 215 – Create a new rule (third step)

Third step choose the type of source port and destination port [any port/special port].

User ACL												
Index	Policy	Protocol	In Interfaces	Out Interfaces	Source IP	Source Netmask	Source Port	Dest IP	Dest Netmask	Dest Port	Action	
1	DROP	tcp	any	any		255.255.255.255			255.255.255.255		Save Cancel	

Figure 216 – Create a new rule (fourth step)

Fourth step, fill out the source IP address and destination IP address (including IP address and net mask, if you choose “any IP” in second step, you need not fill out the IP address); fill out the source port and destination port (if you select any port in third step or select protocol ICMP/all, you need not fill out the port).

User ACL												
Index	Policy	Protocol	In Interfaces	Out Interfaces	Source IP	Source Netmask	Source Port	Dest IP	Dest Netmask	Dest Port	Action	
1	ACCEPT	tcp	wlan1_0	bridge2_0	192.168.3.0	255.255.255.0	12	192.168.6.0	255.255.255.0	45	Delete Edit Sort	

[Add](#)

Figure 217 – Create a new rule (fifth step)

After complete the rule configuration, click the “apply changes” button to save your configuration.

You can also re-order your rules if you have many rules configured and arrange the priority of them. The rule with index 1 has the highest priority; with index 2 has the second high priority and so on.

User ACL												
Index	Policy	Protocol	In Interfaces	Out Interfaces	Source IP	Source Netmask	Source Port	Dest IP	Dest Netmask	Dest Port	Action	
1	ACCEPT	tcp	wlan1_0	bridge2_0	192.168.3.0	255.255.255.0	12	192.168.6.0	255.255.255.0	45		
2	DROP	icmp	any	any	any	-	any	192.168.2.0	255.255.255.255	any	Save Cancel	

Figure 218 – re-order rules

Click **Edit Sort** button of one rule to re-order its priority and then select the index number, click **Save** button to save your changes.

User ACL											
Index	Policy	Protocol	In Interfaces	Out Interfaces	Source IP	Source Netmask	Source Port	Dest IP	Dest Netmask	Dest Port	Action
1	ACCEPT	tcp	wlan1_0	bridge2_0	192.168.3.0	255.255.255.0	12	192.168.6.0	255.255.255.0	45	Delete Edit Sort
2	DROP	icmp	any	any	any	-	any	192.168.2.0	255.255.255.255	any	Delete Edit Sort
Add											
Apply Changes						Discard Changes					

Figure 219 –Apply or Discard User ACL Changes

Apply Changes – to save all changes of User ACL at once

Discard Changes – restore all previous values



Please be careful to use the DROP policy. For example, if DROP tcp for any source IP, BW1254 web UI will not be accessed.

User | Walled Garden

The **walled garden** is an environment that controls the user's access to Web content and services. It is to define a free, restricted service set for a user do not logged into the system. Use the **User | walled garden** menu to view or change the free URLs or hosts:

Walled Garden URLs				
URL for User	String to Display	Action		
no free site (or walled garden) URL is specified				
		new URL		
Walled Garden Hosts				
Type	Host	Netmask	Port	Action
no free site (or walled garden) host is specified				
				new host

Figure 220 –Walled Garden

New URL – click the **new URL** button and enter the new URL and its description. Save entered information by clicking the **update** button:

Walled Garden URLs		
URL for User	String to Display	Action
<input type="text" value="http://www.test.com"/>	<input type="text" value="welcome"/>	Save Cancel

Figure 221 – Add New URL part 1

URL for User – define full URL address. Ex:[http://www.test.com]

String to Display – site description visible to user listed on the **welcome** and **login** page:

LOGIN TO

IP address 192.168.2.1
 MAC address 00:13:D4:D8:DB:7E

login name

password

WELCOME

Get help [here](#)

Click [here](#) to logon.

You are not required to log-in, to browse following sites:
[welcome browan](#)

Figure 222 – Walled Garden link in the Welcome Page

New Host – If you need to define hosts (web servers) for walled garden, specify hosts by clicking the **new host** button and click the **update** button:

Walled Garden Hosts

Type	Host	Netmask	Port	Action
TCP	<input style="width: 100%;" type="text"/>	255.255.255.255	<input style="width: 100%;" type="text"/>	<input type="button" value="Save"/> <input type="button" value="Cancel"/>

Figure 223 – Walled Garden Host

Type –select the data traffic protocol for host server [TCP/UDP].

Host – Web server address [IP address or host name].

Netmask – enter the network mask to specify the host servers network.

Port – network port, which is used to reach the host [1-65535]. For standard protocols use the default ports:

Protocol	Port
HTTP	80
HTTPS	443
FTP	21

User | WISP

Different **WISPs** (Wireless Internet Service Providers) can be associated with appropriate RADIUS servers and device interfaces using the **User | WISP** menu:

WISP

Domain Policy	Username Prefix Length	Action
Username@Domain	N/A	<input type="button" value="edit policy"/>
Name	RADIUS Name	Action
No WISPs are defined on system.		
<input type="button" value="Add WISP"/>		

Note: When select the policy "use username prefix", assure the length of the wisp name will be equal to the setting of "Username Prefix Length"

Figure 224 – WISP Menu

Domain policy means BW1254 use which policy to fetch WISP name from user name then to judge user belong which domain.

	Up to 32 WISP entries can be defined using the User WISP menu.
---	--

The owner can use three policies to judge the WISP name from user name:

1. username follow the format: **username@WISPdomain**
2. username follow the format: **WISPdomain/username**
3. use prefix of username as wisp name, the range of prefix length is from 2 to 6

WISP		
Domain Policy	Username Prefix Length	Action
use username prefix	4	Save Cancel
<ul style="list-style-type: none"> Username@Domain Domain/UserName use username prefix No WISPs are defined on system. 	RADIUS Name	Action
		Add WISP

Note: When select the policy "use username prefix", assure the length of the wisp name will be equal to the setting of "Username Prefix Length"

Figure 225 – Domain Policy

Add WISP – click to define WISP for RADIUS server

WISP		
Domain Policy	Username Prefix Length	Action
Username@Domain	N/A	edit_policy
Name	RADIUS Name	Action
browan	DEFAULT	Save Cancel

Note: When select the policy "use username prefix", assure the length of the wisp name will be equal to the setting of "Username Prefix Length"

Figure 226 – Define New WISP

Name – new WISP domain name [string, up to 256 symbols, no space, dot or dash allowed]

RADIUS Name – select RADIUS for new WISP from list box [non editable]

Save – click the button to save the new WISP

Cancel – restore all previous values

WISP		
Domain Policy	Username Prefix Length	Action
Username@Domain	N/A	edit_policy
Name	RADIUS Name	Action
browan	DEFAULT	Edit Delete
		Add WISP

Note: When select the policy "use username prefix", assure the length of the wisp name will be equal to the setting of "Username Prefix Length"

Apply Changes	Discard Changes
-------------------------------	---------------------------------

Figure 227 – Apply or Discard Changes of WISP settings

BW1254 needs to be restarted to apply all settings changes when clicking **Apply Changes**. Request for reboot server appears:

WISP		
Domain Policy	Username Prefix Length	Action
Username@Domain	N/A	edit policy
Name	RADIUS Name	Action
browan	DEFAULT	Edit Delete
		Add WISP

Note: When select the policy "use username prefix", assure the length of the wisp name will be equal to the setting of "Username Prefix Length"

[Reboot](#)

System needs to be restarted to make the new configurations take effect.

Figure 228 – Reboot information

Reboot – click the button to restart the server and apply the changes.



If there is no other settings needed to be modified, click the **Reboot** button to apply all changes. If there are any other settings need to be changed, continuously to finish and apply all changes and then click **Reboot** button to restart and take effect for all settings.

User | Start Page

The **start page** is the default web page where users will be redirected after log-on. This value will be overwritten by the WISP RADIUS attribute no.4 "Redirection-URL" if provided in the authentication response message. Use the **User | Start Page** menu to view or change the start page URL:

Start Page		
Name	Value	Action
Start Page URL	http://www.xxxx.com	Edit

Figure 229 – Start Page

The administrator can change the **start page** by clicking the **Edit** button. The value entry field will change into an editable field:

Start Page		
Name	Value	Action
Start Page URL	<input type="text" value="http://www.xxxx.com"/>	Save Cancel

Figure 230 – Edit Start Page

Value – enter new redirection URL of start page in valid format [http://www.startpageurl.com]

Save –click the button to save new settings

Cancel – restores all previous values



Figure 231 – Apply or Discard Changes of Start Page

BW1254 needs to be restarted to apply all settings changes when clicking **Apply Changes**. Request for reboot server appears:



Figure 232 – reboot device

Reboot – click the button to restart the server and apply the changes.

i

If there is no other settings needed to be modified, click the **Reboot** button to apply all changes. If there are any other settings need to be changed, continuously to finish and apply all changes and then click **Reboot** button to restart and take effect for all settings.

User | Customized UAM

Customized UAM let owner upload their own login and logout page to BW1254 to apply with enterprise style or do advertisements.

User customized page is based on HTML.

BW1254 support internal and external customized UAM. Internal means user can upload their html login and logout page to BW1254. External means BW1254 will go to an external web server to fetch login and logout page the local and push to web login client.

i

Please contact with BROWAN if you need the internal customized UAM template sample.

Customized UAM in default is disabled. Click the **Edit** button on the setting you need to change:

Customized UAM		
Description	Status	Action
Use SSL	disabled	<input type="button" value="Edit"/>
Customize Page	disabled	<input type="button" value="Edit"/>

Figure 233 – Customized UAM page

Use SSL – select enable or disable to use SSL encryption for the HTTP session of the user login page

Customize Page – enable the configuration if you want to use customized UAM function

After successfully enabled customized UAM configuration, this configuration page will be extended to the follow page which includes three columns.

Customized UAM		
Description	Status	Action
Use SSL	enabled	Edit
Customize Page	enabled	Edit
Pop Logout Page	enabled	Edit
Logout Page width size: 350	Logout Page Height size: 390	Edit
Use External Page	disabled	Edit
Update HTML Files		
Description	Action	
Delete all uploaded HTML and images files!	Delete	
Upload HTML and image files!	Upload	
See example login html page here and See example logout html page here		
Uploaded File List		

Figure 234 – Customized UAM enabled

First is Customized UAM status configuration:

Pop Logout Page – after user successful web login, if this item is enabled, BW1254 will pop out a logout page for user. In default this setting is enabled if customized page is enabled

Logout Page’s Dimension – for the difference of logout page’s dimension which make by customer, BW1254 will use this data to pop out user’s customized logout page

Use External Page – if this item is enabled, BW1254 will fetch login and logout page from an external web server

Second is update html files, for user delete or upload login and logout pages. There also has two URL point to example page in html format for login and logout page which user can reference to make their own pages.

The third is uploaded file list, where user can find which files have been uploaded.

Press upload button on second column will coming into upload files pages:

Customized UAM		
Description	Status	Action
Use SSL	enabled	Edit
Customize Page	enabled	Edit
Pop Logout Page	enabled	Edit
Logout Page width size: 350 Logout Page Height size: 390		Edit
Use External Page	disabled	Edit
Update Custom UAM Files		
Login File	<input type="text" value="F:\uploads\aplogin.html"/>	Browse...
Logout File	<input type="text" value="F:\uploads\aplogout.html"/>	Browse...
Additional file 01	<input type="text" value="F:\uploads\back.gif"/>	Browse...
Additional file 02	<input type="text" value="F:\uploads\by.jpg"/>	Browse...
Additional file 03	<input type="text" value="F:\uploads\line1.gif"/>	Browse...
Additional file 04	<input type="text" value="F:\uploads\line2.gif"/>	Browse...
Additional file 05	<input type="text" value="F:\uploads\line.jpg"/>	Browse...
Additional file 06	<input type="text" value="F:\uploads\logo.jpg"/>	Browse...
Additional file 07	<input type="text"/>	Browse...
Additional file 08	<input type="text"/>	Browse...
Additional file 09	<input type="text"/>	Browse...
Additional file 10	<input type="text"/>	Browse...
		Upload Cancel

Figure 235 – Upload Pages

Login File is for customized login page; **Logout File** is for customized logout page.

Additional file 01~10 is for uploading picture and CSS files. Current support picture file format is JPG, GIF, PNG and CSS.

	Picture and CSS files name need be consistent with your login or logout html pages. The login and logout html file can be what ever you want.
---	---

	Don't forget fill out the Logout page's dimension , or logon user maybe can only see part of your logout page.
---	---

After select the file you want, press upload button and the files will upload to BW1254. after successful upload files, you can see the page below:

Customized UAM		
Description	Status	Action
Use SSL	enabled	Edit
Customize Page	enabled	Edit
Pop Logout Page	enabled	Edit
Logout Page width size: 350 Logout Page Height size: 390		Edit
Use External Page	disabled	Edit
Update HTML Files		
Description	Action	
Delete all uploaded HTML and images files!	Delete	
Upload HTML and image files!	Upload	
See example login html page here and See example logout html page here		
Uploaded File List		
aclogin.html		
aclogout.html		
back.gif		
by.jpg		
line.jpg		
line1.gif		
line2.gif		
logo.jpg		

Figure 236 – Flash upload files OK

After successful flash the files, uploaded files will appear in uploaded file list.

Next is an example for customized login and logout page.



Figure 237 – Example login and logout page

For external page, enabled the “Use External Page” as below.

Customized UAM		
Description	Status	Action
Use SSL	disabled	Edit
Customize Page	enabled	Edit
Pop Logout Page	enabled	Edit
Logout Page width size: 350 Logout Page Height size: 390		Edit
Use External Page	enabled	Edit
External Login page URL:	http://192.168.123.6/login.html	
External Logout page URL:	http://192.168.123.80/logout.html	Edit
Update external page interval(Sec.):	7200	Edit
Update extern login and logout URL page immediately		Done
See example external login html page here and See example external logout html page here		

Figure 238 – External Page Configuration

Fill out the external login page and external logout page [http://host IP address:port/path]. BW1254 would auto-update the external page every 7200 seconds or you change the interval update time. External page example will be found in the links under the last line.

	In External page mode, BW1254 will only fetch the login and logout html page to local, the picture or the CSS file which link on the customized login/logout page will not be fetch. So the link to the picture and CSS file on user customized html file need to be an absolute address which point to the external web server.
---	--

	BW1254 would use the default login or logout page if user did not upload the customized pages or BW1254 did not get the external page from the external login/logout page IP.
---	---

User | Pages

	Detailed description about user page customization is given in the Chapter 5 – User Pages .
---	--

The **welcome/login/logout/help** pages can be easily changed to user defined pages by choosing the **edit** menu. The **pages** configuration menu is displayed by default:

Pages				
Page	Use	Status	Location	Action
welcome	internal	enabled	welcome.xsl	Edit
login	internal	-	login.xsl	Edit
logout	internal	-	logout.xsl	Edit
help	internal	-	/tmp/links/help.html	Edit
unauthorized	internal	-	/tmp/links/unauthorized.html	Edit
Caching				
Status				Action
enabled				Edit
clear cached templates				Clear

Figure 239 – Available User Pages for Configuration

Login/Logout/Help/Unauthorized pages settings detailed description is given in the **Chapter 5 – User Pages**. Only **Welcome** page settings reference is provided here.

Welcome – first page the user gets when he/she opens its browser and enters the URL.

Internal – choose this option when using the internal user pages templates.

External – choose this option when uploading your own user pages templates.

Redirect – choose this option when using the **Extended UAM** function (see **Chapter 5 – User Pages**).

Status – choose enable/disable welcome page status. Note that redirect option with status ‘disabled’ would work.

Location – enter location for external templates or redirect (e.g. WAS IP address).

Pages				
Page	Use	Status	Location	Action
welcome	redirect	enabled	http://192.168.1.23.81/portal/	Edit
login	internal	-	login.xsl	Edit
logout	internal	-	logout.xsl	Edit
help	internal	-	/usr/local/G8000/links/help.html	Edit
unauthorized	internal	-	/usr/local/G8000/links/unauthorized.html	Edit

Figure 240 – Redirect User Pages

Welcome page with **redirect** option selected redirects the user authentication process to the specified location. The user welcome/login/logout page can be implemented as simple HTML (not required to use the .XSL or default user pages templates) in such case.

	The redirect location URL should be specified in Walled Garden URL, otherwise the redirect would NOT WORK.
---	--

Caching	
Status	Action
enabled	Edit
clear cached templates	Clear

Figure 241 – Caching Option

Caching option can be used for caching the external uploaded user pages (available choice: enabled/disabled)

Clear – click the button to clear cached user pages.

	Controller cache is also cleared after device reboot/reset.
---	---

User | Upload

	Please contact with BROWAN if you need the user pages template sample .
---	--

Upload	
Description	Action
Before uploading new template files and images, please delete old files. There is limited space on server for templates and images.	Delete
Upload new template files and images. Old files will be overwritten, if exist with the same name. If you need, you can repeat upload process few times, until upload all needed images (you do not need to upload template files twice). Please remember, that server space is limited! All files will be uploaded to "images" directory, please prepare your templates to use images and stylesheets from that directory.	Upload

Figure 242 – Upload Page

Delete – click the button to delete earlier uploaded files from controller memory.

Upload – click the button to select and upload new user pages.

	How to upload user pages see in the Chapter 5 – User Pages .
---	---

User | HTTP Headers

System administrator can set **HTML headers encoding** and **language** settings for BW1254 web management interface and new uploaded user pages. Select **User | HTTP Headers** menu:

HTTP Headers			
Description	Enabled	Value	Action
Content-Type	no	-	Edit
Content-Language	no	-	Edit

Figure 243 – HTTP Headers Settings

BW1254 device supports some http META tags. Syntax of such META tags:

```
<META HTTP-EQUIV="name" CONTENT="content" >
```

Currently BW1254 supports **Content-Type** and **Content-Language** tags:

- **Content-Type** is used to define document char set (used, when text has non-Latin letters, like language letters).
- **Content-Language** may be used to declare the natural language of the document.

BW1254 automatically adds defined content-type and content-language to generated XML. Then user pages (.XSL) templates will use these parameters to generate the output HTML.

Click the change button to define new headers of the web management interface on user pages templates. The default HTML encoding is **ISO-8859-1**, language = **English**. Enable the HTTP header status and default values appear:

HTTP Headers			
Description	Enabled	Value	Action
Content-Type	no	ISO-8859-1	Save Cancel
Content-Language	no	-	

Figure 244 – Set HTTP Headers

The system administrator can set his own header encoding and language settings.

	Use the HTML 4.01 specification to define the header encoding and language.
---	---

User | Remote Authentication

	Read more about the extended UAM feature in Chapter 5 – User Pages , section: Extended UAM
---	--

The **Remote Authentication** feature under the **User** menu allows an external Web Application Server (WAS) to intercept/take part in the user authentication process, and to log on and log off users externally. It provides a means to query user session information as well. By default such remote authentication is disabled:

Remote Authentication		
Description	Value	Action
remote authentication	disabled	Edit
shared secret	none	Edit

Figure 245 – Remote Authentication

Click the **edit** button next to appropriate settings to specify **remote authentication** parameters:

Remote Authentication		
Description	Value	Action
remote authentication	disabled	
shared secret	none	Save Cancel

Figure 246 – Enable Remote Authentication

Remote Authentication – select status: [enabled/disabled].

Shared Secret – enter password for WAS to communicate with AC [string (4-32), no spaces allowed].

	The shared secret must match that configured on the WAS. This shared secret allows the WAS to initiate a secure (SSL) command session with the BW1254 to pass login commands.
---	---

Services

Services | Telnet

Use **Services | Telnet** menu to manage the telnet/SSH service of your BW1254.

Telnet		
Name	Status	Action
Telnet Service	Enabled	Edit
SSH Service	Enabled	Edit

Figure 247 – System Configuration settings

Telnet Service – Enable or disable telnet service of BW1254

SSH Service – Enable or disable SSH service of BW1254

The default of these two services are all **Enabled**. The current IETF SSH (SSHv2) is supported for security of accessing BW1254 via telnet/CLISH.

Services | SNMP

SNMP is the standard protocol that regulates network management over the Internet. To communicate with SNMP manager you must set up the same **SNMP** communities and identifiers on both ends: manager and agent.

Use the **Services | SNMP** menu to change current SNMP configuration.

General Configuration		
Name	Value	Action
Readonly community	public	Edit
Readwrite community	private	Edit
DefaultTrap community	public	Edit
HeartBeat Trap Interval	0 seconds	Edit

Trap Configuration					
Index	Host Ip	Host Port	Trap Type	Community	Action
1	192.168.120.62	162	trapsink	test	Delete
Add					

Figure 248 – SNMP settings

Readonly community – community name is used in SNMP version 1 and version 2c. Read-only (public) community allows reading values, but denies any attempt to change values [1-32 all ASCII printable characters, no spaces]

Readwrite community – community name is used in SNMP version 1 and version 2c. Read-write (private) community allows to read and (where possible) change values [1-32 all ASCII printable characters, no spaces]

Default Trap community – the default SNMP community name used for traps without specified communities. The default community by most systems is "public". The community string must match the community string used by the SNMP network management system (NMS) [1-32 all ASCII printable characters, no spaces]

HeartBeat Trap Interval – define the interval that AP send trap information to the server.[in seconds]

Trap Configuration Table:

You can configure your SNMP agent to send **SNMP Traps** (and/or inform notifications) under the defined host (SNMP manager) and community name (optional).

Trap Configuration					
Index	Host Ip	Host Port	Trap Type	Community	Action
1	192.168.120.62	162	trapsink	test	<input type="button" value="Delete"/>
<input type="button" value="Add"/>					

Figure 249 – SNMP Trap table settings

Click **Add** to add a new SNMP manager or **Delete** to delete a specific SNMP manager. Clicking **Add**:

Trap Configuration					
Index	Host Ip	Host Port	Trap Type	Community	Action
No entry in list					
	<input type="text" value="192.168.123.66"/>	<input type="text" value="162"/>	<input type="text" value="trapsink"/> <ul style="list-style-type: none"> trapsink <li style="background-color: #e0e0e0;">trap2sink informsink 	<input type="text" value="test"/>	<input type="button" value="Save"/> <input type="button" value="Cancel"/>

Figure 250 – Add SNMP Trap

Host IP – enter SNMP manager IP address [dots and digits]

Host Port – enter the port number the trap messages should be send through [number]

Trap Type – select trap message type [v1/v2/inform]

Community – specify the community name at a SNMP trap message. This community will be used in trap messages to authenticate the SNMP manager. If not defined, the default trap community name will be used (specified in the SNMP table) [1-32 all ASCII printable characters, no spaces]

Save – save all current settings

Cancel – restore the last settings

Services | NTP

NTP (Network Time Protocol) is used to synchronize the system time with the selected network NTP server. Use the **Services | NTP** menu to configure the NTP service:

NTP Server		
NTP Status	<input type="text" value="disable"/>	
Time Zone	<input type="text" value="GMT-12:00"/>	
Name	ServerIP	Action
No entry in list		
<input type="button" value="Add"/>		

Figure 251 – NTP Settings

NTP Status – specify enable or disable this NTP service

Time Zone – specify the time zone for NTP service

Delete – delete the existed NTP server

Edit – edit the settings of the existed NTP server

Add – add a new NTP server setting for synchronizing time

Clicking **Add** button to add a new NTP server:

NTP Server	
Name	ServerIP
<input type="text" value="Ntpserver"/>	<input type="text" value="207.46.103.100"/>
<input type="button" value="Save"/> <input type="button" value="Cancel"/>	

Figure 252 – Add new NTP server setting

	<p>Two NTP servers can be configured under Services NTP menu. And only IP address is accepted for NTP server.</p> <p>Please enter at least one NTP server when enable NTP service.</p>
---	---

	<p>The Name of NTP server should be unique.</p>
---	--

Change status or leave in the default state if no editing is necessary and click the **Save** button.

NTP Server		
NTP Status <input type="text" value="disable"/>		
Time Zone <input type="text" value="GMT-12:00"/>		
Name	ServerIP	Action
time.nist.gov	192.43.244.18	<input type="button" value="Delete"/> <input type="button" value="Edit"/>
<input type="button" value="Add"/>		

<input type="button" value="Apply Changes"/>	<input type="button" value="Discard Changes"/>
--	--

Figure 253 – Save the NTP server Changes

Change the Time Zone for your own local time and change the NTP status to enable or disable.

NTP Server		
NTP Status <input type="button" value="enable"/>		
Time Zone <input type="button" value="GMT+08:00"/>		
Name	ServerIP	Action
time.nist.gov	192.43.244.18	<input type="button" value="Delete"/> <input type="button" value="Edit"/>
<input type="button" value="Save"/> <input type="button" value="Cancel"/>		

Figure 254 – Edit Time Zone setting/NTP status

Click **Save** button to save new Time Zone setting.

NTP Server		
NTP Status <input type="button" value="enable"/>		
Time Zone <input type="button" value="GMT+08:00"/>		
Name	ServerIP	Action
time.nist.gov	192.43.244.18	<input type="button" value="Delete"/> <input type="button" value="Edit"/>
<input type="button" value="Add"/>		

Figure 255 – Apply or Discard Time Zone/NTP status Changes

For each change of settings, the BW1254 needs to be restarted to apply all settings changes when clicking **Apply Changes**. Request for reboot server appears:

NTP Server		
NTP Status <input type="button" value="enable"/>		
Time Zone <input type="button" value="GMT+08:00"/>		
Name	ServerIP	Action
time.nist.gov	192.43.244.18	<input type="button" value="Delete"/> <input type="button" value="Edit"/>
<input type="button" value="Add"/>		

System needs to be restarted to make the new configurations take effect.

Figure 256 – Reboot information

Reboot – click the button to restart the server and apply the changes

	If there is no other settings needed to be modified, click the Reboot button to apply all changes. If there are any other settings need to be changed, continuously to finish and apply all changes and then click Reboot button to restart and take effect for all settings.
---	---

Services | Time

Configure the system time manually under **Services | Time** menu.

Date and Time	
Date	2006/07/07
Time	18:46
<input type="button" value="Edit"/> <input type="button" value="Refresh"/>	

Figure 257 – Time Settings

Click **Edit** to change current system time.

Date and Time	
Date	<input type="text" value="2006"/> / <input type="text" value="07"/> / <input type="text" value="7"/>
Time	<input type="text" value="18"/> : <input type="text" value="46"/>
<input type="button" value="Apply"/> <input type="button" value="Cancel"/>	

Figure 258 – Edit Date and Time Settings

Change the Date and Time or leave in the default value if no editing is necessary and click the **Apply** button. Thus the modified time will be taken effect at once. No reboot is needed.

	If NTP is enabled, the local time cannot be modified.
---	---

	Since BW1254 hasn't RTC (real-time clock), the system time will back to 1970/01/01 00:00 after reboot.
---	--

Services | Watchdog

BW1254 supply watchdog function for the reliability. Use **Services | Watchdog** to enable/disable watchdog service.

Watchdog			
Name	Status	Check Interval	Action
Software Watchdog	Enabled	10 Seconds	<input type="button" value="Edit"/>
Hardware Watchdog	Enabled		<input type="button" value="Edit"/>

Figure 259 – Watchdog settings

Click Edit button to edit watchdog settings. The similar UI will be appeared like below:

Watchdog			
Name	Status	Check Interval	Action
Software Watchdog	Enabled <input type="button" value="v"/>	10 <input type="text"/> Seconds	<input type="button" value="Save"/> <input type="button" value="Cancel"/>
Hardware Watchdog	Enabled		<input type="button" value="Edit"/>

Figure 260 – edit Software Watchdog settings

Status – Enable or Disable software watchdog

Check Interval – the periodical time that software watchdog checks the whole file system of BW1254.

The hardware watchdog function will protect device even the operation system crash.

Watchdog			
Name	Status	Check Interval	Action
Software Watchdog	Enabled	10 Seconds	<input type="button" value="Edit"/>
Hardware Watchdog	Enabled <input type="button" value="v"/>		<input type="button" value="Save"/> <input type="button" value="Cancel"/>

Figure 261 – edit hardware watchdog settings

Status – Enable or Disable hardware watchdog

	The default value is enabled for both Software Watchdog and Hardware Watchdog. It is strongly recommended to enable the watchdog function.
--	--

Click **Save** and follow the UI instruction to apply changes and reboot the device for apply all the modified settings.

System

System | Administrator

The **System | Administrator** menu is for changing the administrator’s settings: username and password:

Administrator	
User Name	<input type="text" value="admin"/>
Old Password	<input type="text"/>
New Password	<input type="text"/>
Confirm Password	<input type="text"/>
<input type="button" value="Save"/> <input type="button" value="Cancel"/>	

Figure 262 – system security settings



User Name – administrator username for access to BW1254 (e.g. web interface, CLI mode) [1-32 symbols, spaces not allowed]

Old Password – old password value

New Password – new password value used for user authentication in the system [4-8 characters, spaces not allowed]

Confirm Password – re-enter the new password to verify its accuracy

Save – click to save new administrator settings.

	Default administrator logon settings are: User Name: admin Password: admin01
	Password length is from 4 to 8 characters.

After filling in the right Old password and the New Password, clicking the **Save** button for taking effect immediately.

After clicking **Save** button, the below UI will be shown to notify that the new password setting has been taken place:

Set password successfully.

Administrator	
User Name	<input type="text" value="admin"/>
Old Password	<input type="text"/>
New Password	<input type="text"/>
Confirm Password	<input type="text"/>
<input type="button" value="Save"/> <input type="button" value="Cancel"/>	

Figure 263 – system security settings save and take effect successfully

System | System Log

Use the **System | System Log** menu to trace your AP system processes and get the system log locally or on the remote log server.

Remote System Log			
Remote Log Status	Host IP	Log Level	Action
Disabled	192.168.2.1	info	Edit

Local System Log			
Local Log Status	Log Limit (bytes)	Log Level	Action
Enabled	102400	debug	Edit
View Log Messages			View

Figure 264 – System Log settings

To enable the **System Log** remote sending function, click the **Edit** button on the Remote System Log table and choose the **enabled** option:



Remote System Log			
Remote Log Status	Host IP	Log Level	Action
Enabled <input type="button" value="v"/>	<input type="text" value="192.168.2.1"/>	Info <input type="button" value="v"/>	Save Cancel

Figure 265 – Configure Remote System Log Utility

Remote Log Status – choose disable/enable remote log [enabled/disabled]

Host IP – specify the host IP address where to send the **System Log** messages [dots and digits]

Log Level – specify the remote log message level you want to trace [critical, error, warning, info and debug]

	Do not output “debug” log unless there are important issue needs to be clarified. Debug log will output all of the information so that it will severely drop down the network performance.
	BW1254 support standard sys. log server.

Save – save changes

Cancel – restore the previous values

To view the **System Log** locally, click the **Edit** button on the Local System Log table and choose the **enabled** option:

Local System Log			
Local Log Status	Log Limit (bytes)	Log Level	Action
Enabled <input type="button" value="v"/>	<input type="text" value="102400"/>	Debug <input type="button" value="v"/>	Save Cancel
View Log Messages			View

Figure 266 – Configure Local System Log

Local Log Status – choose disable/enable local log [enabled/disabled]

Log Limit – specify the maximum length of local log message in byte [20000-512000]

Log Level – specify the local log message level you want to trace [critical, error, warning, info and debug]

Save – save changes

Cancel – restore the previous values

View – view the log messages locally

Click **View** button, a similar screen will appear as below:

Local Log Messages	
Messages	Action
Clear All Log Messages:	<input type="button" value="Clear"/>
Jan 1 03:17:59 P720 [G8000]: messages is null, so continue	
Jan 1 03:18:05 P720 last message repeated 3 times	
Jan 1 03:18:08 P720 [G8000]: cmd is equal to refreshlog button	
Jan 1 03:18:08 P720 [G8000]: messages is null, so continue	
<input type="button" value="Refresh"/> <input type="button" value="Return"/>	

Figure 267 – View Local Log Messages

Clear – clear current log message

Refresh – get the updated log messages

Return – back to System Log page

System | System Mode

In this page, you can select the system mode of your BW1254.

System Mode					
Mode	Interface	IP	Netmask	Gateway	Protocol
<input type="radio"/> AP					
	LAN	<input type="text" value="192.168.123.159"/>	<input type="text" value="255.255.255.0"/>	<input type="text" value="192.168.123.1"/>	<input type="text" value="static"/> ▼
<input checked="" type="radio"/> AP Router					
	WAN	<input type="text" value="192.168.123.159"/>	<input type="text" value="255.255.255.0"/>	<input type="text" value="192.168.123.1"/>	<input type="text" value="static"/> ▼
<input type="button" value="Apply and Reboot"/>					

Figure 268 – System Mode Settings

Mode – select whether the system mode of BW1254 is AP mode or AP Router mode

IP – specify the IP address of current interface [dots and digits]

Netmask – specify the subnet mask of current interface [dots and digits]

Gateway – specify the gateway to other networks

Protocol – specify **static** for setting IP address manually and **dhcp** for getting IP address dynamically acting as DHCP client

Apply and Reboot – click the button to restart the device and apply all setting changes

	The Web Interface in AP-Router mode is different from that in AP mode. For the detailed configuration of BW1254 working in AP mode, please refer to: Chapter 3 – Reference Manual---AP Mode
---	--

System | System Info

Administrator can self-define the device information including the system name, system location and system contact information of his BW1254.

System Info		
Name	Value	Action
System Name	BW1254	<input type="button" value="Edit"/>
System Location	location	<input type="button" value="Edit"/>
System Contact	contact information	<input type="button" value="Edit"/>

Figure 269 – System info Settings

System Name –edit the system name, the column length range is 1 to 255.

System Info		
Name	Value	Action
System Name	<input type="text" value="BW1254"/>	<input type="button" value="Save"/> <input type="button" value="Cancel"/>
System Location	location	
System Contact	contact information	

Figure 270 –edit the system name

System Location – edit the system location, the column length range is 1 to 255.

System Info		
Name	Value	Action
System Name	BW1254	
System Location	<input type="text" value="Taipei 101"/>	<input type="button" value="Save"/> <input type="button" value="Cancel"/>
System Contact	contact information	

Figure 271 –edit the system location

System Contact – edit the system contact, the column length range is 1 to 255.

System Info		
Name	Value	Action
System Name	BW1254	
System Location	Taipei 101	
System Contact	<input type="text" value="Timothy#2651"/>	<input type="button" value="Save"/> <input type="button" value="Cancel"/>

Figure 272 –edit the system contact information

Save – click the button to save the change.

Cancel – restore all previous values

System | Configuration

Use the **System | Configuration** menu to download current configuration or restore specified configuration.

Configuration Backup – download current working system configuration for backup

Configuration Upload – upload system configuration for restore

Configuration Backup	
Description	Action
Configuration file to download	<input type="button" value="Preparation"/>

Configuration Upload	
Description	Action
Configuration file to upload	<input type="text"/> <input type="button" value="Browse..."/>
<input type="button" value="Upload"/> <input type="button" value="Cancel"/>	

Figure 273 – System Configuration settings

Click the **Preparation** button to start saving the configuration file.

Click the **Download** button to download current working configuration locally.

Configuration Backup	
Description	Action
Download and store Configuration backup file in safe place.	<input type="button" value="Download"/>

Figure 274 – Backup settings

By default the device configuration name is cfgbackup.cfg.

	A configuration file name will be required when you download/save the configuration file. And please remember or re-name the file if necessary. The configuration file name should only include characters or numbers. Otherwise, this configuration file will not upload to BW1254.
---	--

You can upload saved configuration file any time you want to restore this configuration to the device by using the **Browse** button. Select the configuration file and upload it on the device:

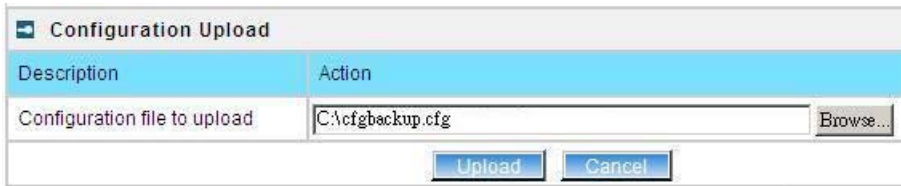

Figure 275 – Configuration Upload/Restore - 1

Click **Upload** for upload the specified configuration and then the similar UI appears

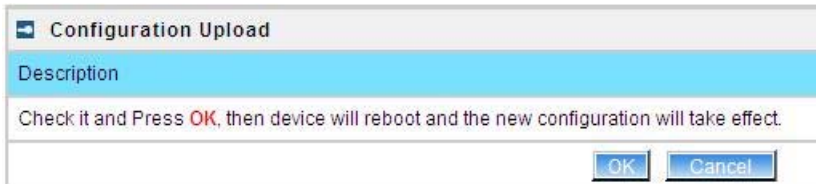

Figure 276 – Configuration Upload/Restore - 2

Click OK button to restore and AP will reboot immediately to take effect.

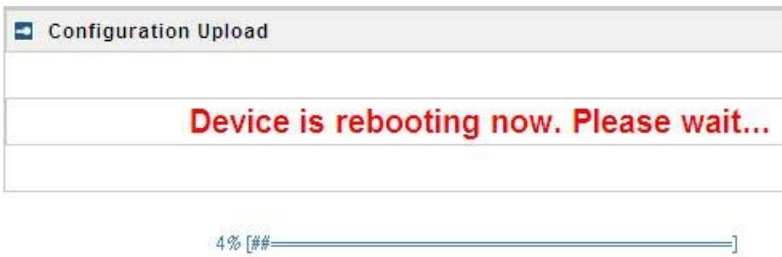

Figure 277 – Configuration Upload/Restore - 3

System | Reset and Reboot

Use this function to reboot device or restore to factory default.

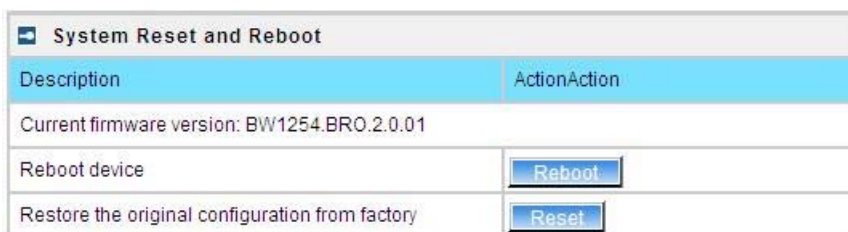

Figure 278 – System Reset setting

Reboot – reboot the device

Reset – reset System to Factory Defaults

To reboot the device, click **Reboot** and then the below appears to make sure:



Figure 279 – Reboot the device

To reset the device, click **Reset** and then the below appears to make sure:



Figure 280 – Reset the device

Click reset button the device will reset and reboot immediately to take effect.

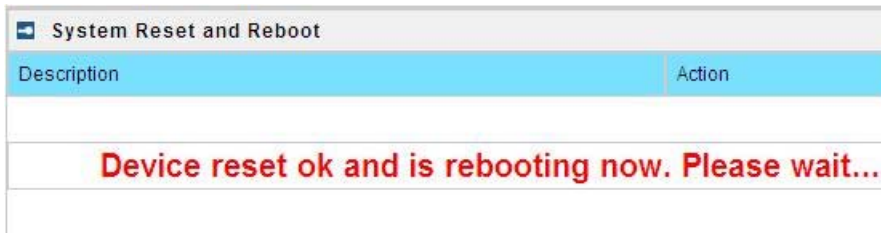

	<p>Please note that all settings including the administrator settings will be set back to the factory default when Reset is implement.</p>
---	---

System | Local Upgrade

Upload – Update your device firmware locally.



Figure 281 – Firmware Upgrade

Click the **Upload** and then click the browse button to specify the full path of the new firmware image and click the **Upload** button:

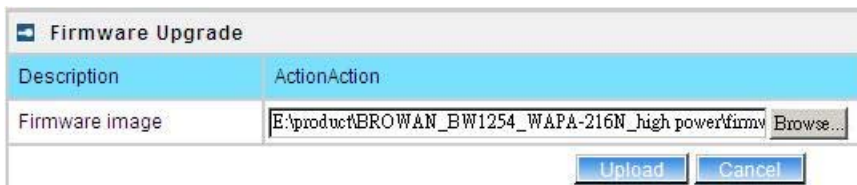



Figure 282 – Firmware Upgrade

Click the **Upgrade** button to flash and upgrade the firmware.

	<p>Please make sure the firmware is correct for BW1254. Otherwise the upgrade will be failed.</p>
---	---

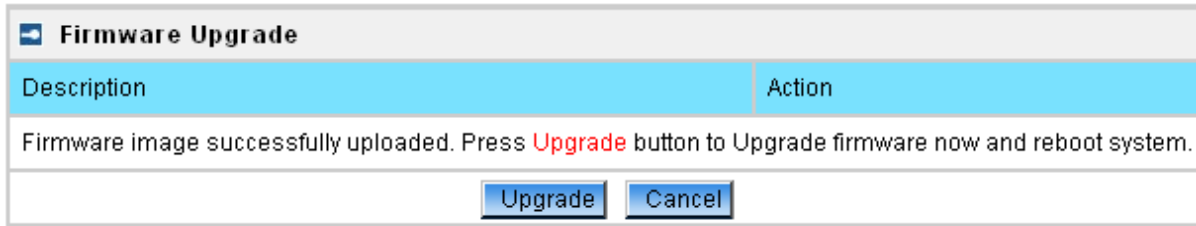
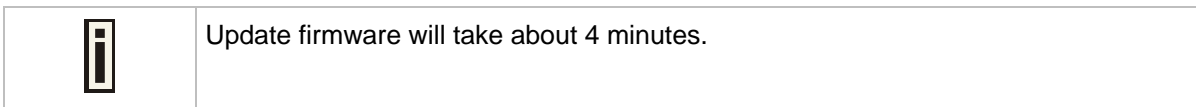
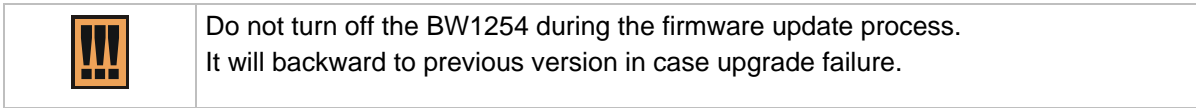

Figure 283 – upgrade firmware



System | TFTP Upgrade

BW1254 support firmware upgrade via TFTP server.



Figure 284 – TFTP Firmware Upgrade

Current firmware version – Show the current firmware version.

TFTP server IP address - Specify the IP address of TFTP server which firmware located.

TFTP Time Out(Seccs) – Specify the TFTP server communication time out in second.

Firmware Filename – Specify the upgrade firmware name to be download.



Figure 285 – TFTP Firmware Upgrade setting

Click “Edit” button to specify the TFTP server IP address,time out interval and firmware filename and save the configuration then press “Download” button to download the firmware.

	Please make sure the firmware is correct for BW1254. Otherwise the upgrade will be failed.
---	--

	Do not turn off the BW1254 during the firmware update process. It will backward to previous version in case upgrade failure.
---	--

System | Location Settings

You can define the longitude and latitude for the device information or for the NMS to locate the device location.

Location Settings	
Name	Value
Longitude	
Latitude	
<input type="button" value="Edit"/>	

Figure 286 – location setting

Click edit to enter the Longitude and Latitude in digit and dot format.

Location Settings	
Name	Value
Longitude	<input type="text" value="121.524611"/>
Latitude>	<input type="text" value="25.040917"/>
<input type="button" value="Save"/> <input type="button" value="Cancel"/>	

Figure 287 – edit location[longitude/latitude]



Click **save** button to save it.

Chapter 5 – User Pages (Based on XSL)

This chapter describes the user pages based on XSL format. Detailed instructions on how to change and upload new user pages are given below.

When launching his/her web browser the user's initial HTTP request will be redirected to an operator defined set of web pages, further called the "user pages". User pages are:

- **Welcome** page– the first page presented to the user.
- **Login** page– subscriber authentication page, allows the user to login to the network.
- **Logout** page– small pop-up window for logged-on user statistics and log-out function.
- **Help** page – get help with the login process.
- **Unauthorized** page – this page is displayed when web login or EAP login methods are disabled on the BW1254 for subscribers.

	The following mentioned user pages are factory default. The operator/owner can upload new templates for all user pages based on their designed.
	Contact with BROWAN if you need the User Pages templates samples.

User Pages Overview

Welcome Page

Welcome page is the first page a subscriber receives when he starts his web browser and enters any URL. By default it's a very simple page and provides only a link to the **login** page.



Figure 288 – Welcome Page

	The operator/owner can change the welcome page according to their designed. See more details in section: Changing User Pages .
---	--

Login Page

The subscriber gets to the **login** page after clicking the link on the **welcome** page. The **login** page is loaded from the BW1254. To get access to the network, the user should enter his authentication settings: **login name** and **password** and click the **login** button:

Figure 289 – Simple Login Page

 The login name and password can be obtained from your Hotspot Operator.

The **login** page also displays subscriber's logical and physical network addresses (IP and MAC). Once authenticated, a **start** page appears. In addition, a smaller **logout** window (page) pops up.

 The operator/owner can change the **login** page according to its needs. See more details in section: **Changing User Pages**.

Logout Page

 Make sure the JavaScript is enabled on your Web browser; otherwise you will not receive the **logout** page.

The **Logout** page contains the detailed subscriber's session information and provides function for logging out of the network:

user	user1
user IP	192.168.3.2
MAC address	00904BBFC873
time length	00:00:02
download bytes	84 bytes
upload bytes	1.04 KB
download bytes left	unlimited
upload bytes left	unlimited
total bytes left	unlimited
time length left	19:59:58
bandwidth downstream	4.00 Mbps
bandwidth upstream	4.00 Mbps

Figure 290 – Logout Page

Detailed subscriber's session information includes:

Logout button – click the button to logout from the network. The log-out pop-up window closes.

Bill button – display subscriber’s billing information (not include current session).

Passwd button – click the button to change subscriber’s password.

User – subscriber’s login name.

User IP – subscriber’s logical network name (IP address).

MAC Address – subscriber’s physical network address.

time length– subscriber’s time length from client log on in format: [hours: minutes: seconds].

Download/upload bytes – subscriber’s session download and upload statistics in bytes.

Download/upload bytes left – session download and upload bytes left for subscriber limited from RADIUS [in B, KB, MB, GB and unlimited].

Total bytes left – session total (download and upload) bytes left for subscriber limited form RADIUS [in B, KB, MB, GB and unlimited].

time length left – time length left in format: [hours: minutes: seconds].

Bandwidth downstream/upstream – available upstream and downstream bandwidth for subscriber limited from RADIUS [in bps].

Refresh button – click the button to refresh the subscriber session information.

	The operator/owner can change the logout page interface according to its needs. See more details in section: Changing User Pages . All session details are further accessible via the operator XML interface.
---	---

Help Page

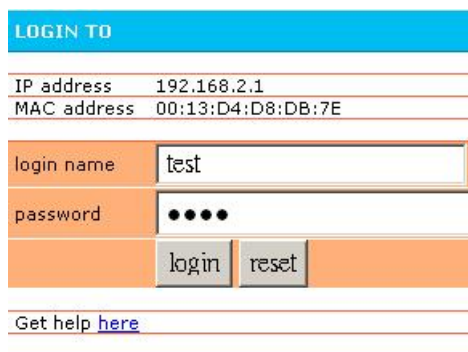

Figure 291 – Get help page

Click on the **get help** link in the **login** page for help tips related to network registration. A page appears similar to the following:

HELP PAGE for PAC	
<p>You got to the login screen, because you are not registered to network. If you want to browse the internet, first you need to log-in. You are not required to log-in, to browse sites, which are listed on login screen bottom. This PAC also could be configured not to allow any free sites (otherwise known as walled garden).</p>	
<p>To register to network, go back to login screen, enter your login name and password and press login. If you do not have login name, ask at nearest information center where you can get/buy account information to register to network at this place.</p>	

Figure 292 – Get help page

	The operator/owner can change the help page according to its needs. See more details in section: Changing User Pages .
---	--

Unauthorized Page

If web log-on method (UAM) or EAP-based authentication methods are disabled on the AC and the subscriber attempts to login to the network, he will receive the following page:

You are unauthorized!

You are not registered to the network and web authentication is not provided on this access controller. Please contact the network administrator.

Figure 293 – Get help page



The operator/owner can change the **unauthorized** page according to its needs. See more details in section: **Changing User Pages**.

Changing User Pages

As the operator/owner you can modify the user pages freely according to your personal needs and preferences. User Page templates can be either stored locally on the AC or on an external web server.

Use the **user interface | configuration** menu to modify user pages. There are two ways to change and store new user page templates:

External – linking new user page templates from an external server.

Internal – upload new templates to local memory.

Supported user pages template formats:

XSL (Extensible Style sheet Language) for welcome/login/logout/one click pages.

HTML (Hypertext Markup Language) for help/unauthorized pages.



The welcome, Login and logout pages must be in .XSL format.

The following image formats are supported for new templates. Other formats are not accepted:

- **PNG**
- **GIF**
- **JPG**

The following examples demonstrate the use of internal and external user pages.



Contact with BROWAN if you need the **User Pages templates samples**.

Example for External Pages

- Step 1** Prepare your new user pages template for each user page: welcome/login/logout/help/unauthorized.
- Step 2** Under the **user interface | configuration | pages** menu select the user page you want to change (e.g. login)

Pages				
Page	Use	Status	Location	Action
welcome	internal	enabled	welcome.xsl	
login	internal	-	login.xsl	Save Cancel
logout	internal	-	logout.xsl	
help	internal	-	/usr/local/G8000/links/help.html	
unauthorized	internal	-	/usr/local/G8000/links/unauthorized.html	

Figure 294 - configure external pages

Step 3 Choose the **external** option under the **use** column:

Pages				
Page	Use	Status	Location	Action
welcome	internal	enabled	welcome.xsl	
login	external	-	login.xsl	Save Cancel
logout	internal	-	logout.xsl	
help	internal	-	/usr/local/G8000/links/help.html	
unauthorized	internal	-	/usr/local/G8000/links/unauthorized.html	

Figure 295 - configure external pages

Step 4 Specify the new user page location in the **location** field (<http://servername/filelocation>):

Pages				
Page	Use	Status	Location	Action
welcome	internal	enabled	welcome.xsl	
login	external	-	http://192.168.2.100/login.xsl	Save Cancel
logout	internal	-	logout.xsl	
help	internal	-	/usr/local/G8000/links/help.html	
unauthorized	internal	-	/usr/local/G8000/links/unauthorized.html	

Figure 296 - configure external pages

	Do not to upload different type of formats. It will not be displayed properly.
---	--

Step 5 Save entered changes with the **apply changes** button:

Pages				
Page	Use	Status	Location	Action
welcome	internal	enabled	welcome.xsl	Edit
login	external	-	http://192.168.2.100/login.xsl	Edit
logout	internal	-	logout.xsl	Edit
help	internal	-	/usr/local/G8000/links/help.html	Edit
unauthorized	internal	-	/usr/local/G8000/links/unauthorized.html	Edit
Caching				
Status				Action
enabled				Edit
clear cached templates				Clear

[Apply Changes](#) [Discard Changes](#)

Figure 297 - configure external pages

Step 6 Check for new uploaded user page (e.g. login):

----- NEW LOGIN -----

login name	
password	
IP address	192.168.2.27
MAC address	000347C92B1C
login reset	
Get help here	

Figure 298 - login page

	<p>If at anytime you wish to restore factory default user pages, click the reset button under the system reset & reboot menu.</p>
---	---

Example for Internal Pages

We will use the **user pages** templates to show the example how to upload the internal pages. Follow the steps below:

	Contact with BROWAN if you need the User Pages templates samples .
---	---

Step 1 Ensure that **internal** option is selected for **all** user pages you want to change. By default internal option is defined for all pages:

Pages				
Page	Use	Status	Location	Action
welcome	internal	enabled	welcome.xml	Edit
login	internal	-	login.xml	Edit
logout	internal	-	logout.xml	Edit
help	internal	-	/usr/local/G8000/links/help.html	Edit
unauthorized	internal	-	/usr/local/G8000/links/unauthorized.html	Edit

Figure 299 - internal pages

Step 2 Under the **user | upload** menu click the **upload** button to upload new prepared user pages:

Upload	
Description	Action
Before uploading new template files and images, please delete old files. There is limited space on server for templates and images.	Delete
Upload new template files and images. Old files will be overwritten, if exist with the same name. If you need, you can repeat upload process few times, until upload all needed images (you do not need to upload template files twice). Please remember, that server space is limited! All files will be uploaded to "images" directory, please prepare your templates to use images and stylesheets from that directory.	Upload

Figure 300 - upload page

	The memory space in the AP for internal user pages is limited to 1 MB .
---	--

Step 3 Specify the location of new user page templates by clicking the **browse** button or enter the location manually.

Specify the location for the additional files of new user page templates: images and a cascading style sheet file (**css**) by clicking the **browse** button or enter the location manually:

Upload		
user template files		
welcome.xsl	D:\Data\F-720\cd content\Examples\welcome.xsl	Browse..
login.xsl	D:\Data\F-720\cd content\Examples\login.xsl	Browse..
logout.xsl	D:\Data\F-720\cd content\Examples\logout.xsl	Browse..
help.html	D:\Data\F-720\cd content\Examples\help.html	Browse..
unauthorized.html	D:\Data\F-720\cd content\Examples\unauthorized.html	Browse..
oneclickuser.xsl		Browse..
images and stylesheet (css) files for templates		
additional file 01	D:\Data\F-720\cd content\Examples\images\login.css	Browse..
additional file 02	D:\Data\F-720\cd content\Examples\images\logout.css	Browse..
additional file 03	D:\Data\F-720\cd content\Examples\images\background.gif	Browse..
additional file 04	D:\Data\F-720\cd content\Examples\images\cntr.gif	Browse..
additional file 05	D:\Data\F-720\cd content\Examples\images\glogo.gif	Browse..
additional file 06	D:\Data\F-720\cd content\Examples\images\right.gif	Browse..
additional file 07	D:\Data\F-720\cd content\Examples\images\stop.gif	Browse..
additional file 08		Browse..
additional file 09		Browse..
additional file 10		Browse..
<input type="button" value="upload"/> <input type="button" value="Cancel"/>		

Figure 301 - upload template files

Step 4 Click the **upload** button to upload specified templates and files.



You do not need to upload all additional files at once. You can repeat the upload process a number of times until all necessary images are uploaded.

Step 5 Check for the newly uploaded user pages and images to ensure that everything is uploaded and displayed correctly. Go to the link:

<https://<device-IP-address>> to get to the new user **welcome** page:



Figure 302 - customize welcome page

Click the **here** link or enter the link directly:

<https://<device-IP-address>/login.user> to get to the new user **login** page:



Figure 303 - customize login page

	If at anytime you wish to restore the factory default user pages, click the reset button under the system reset & reboot menu.
--	--

Extended UAM

The **Extensions** feature (**User** menu) allows an external Web Application Server (WAS) to intercept/take part in the user authentication process externally log on and log off the user as necessary. It provides means to query user session information as well.

See the following schemes to understand how the remote client authentication works.

Scheme 1:

The remote authentication method when client's authentication request is re-directed to the external server (WAS):

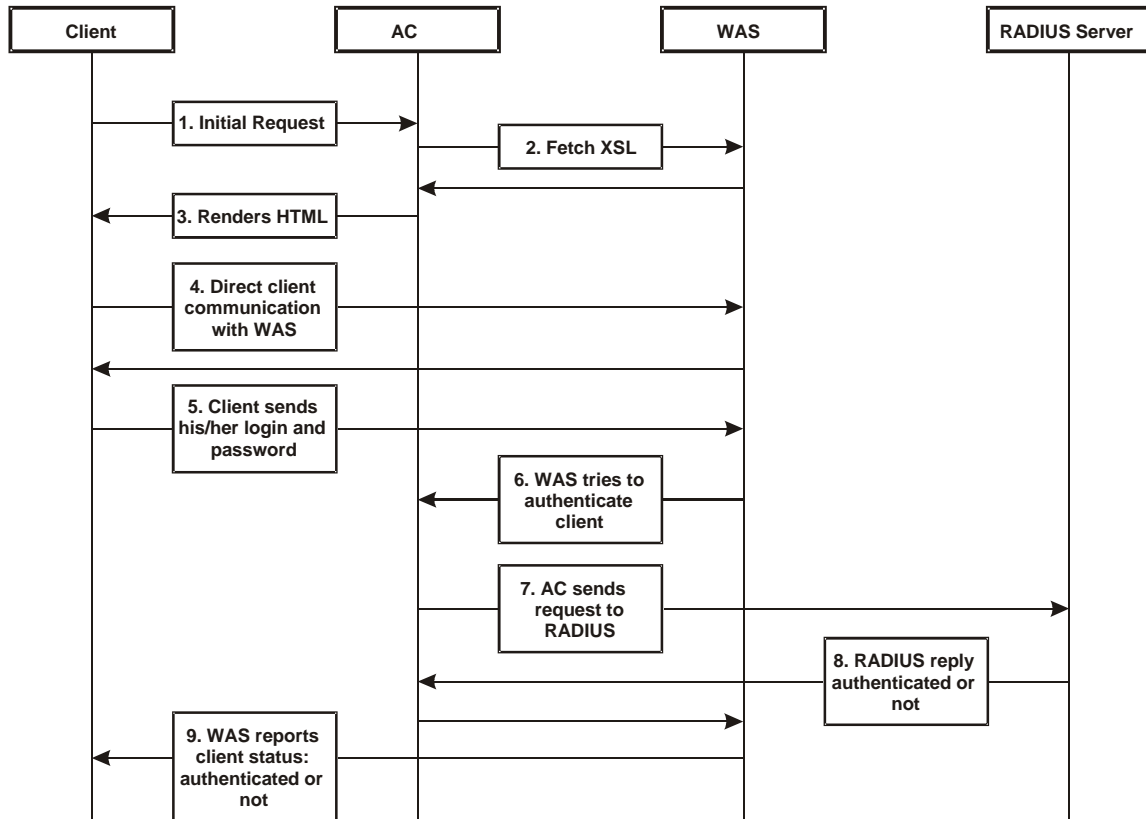



Figure 304 – Client Remote Authentication Scheme (1)

The Client initiates (1) authentication process. AC intercepts any access to the Internet via HTTP and redirects the client to the **welcome**, or **login** URL on AC. In order to render the custom login screen HTML page, the AC must be configured to (2) fetch .XSL script from a remote server, which in this case is a Web Application Server (WAS), or have custom .XSL uploaded on the AC. There is the ability to enable caching of .XSL scripts (see: **User | Pages**), thus avoiding fetching of the same document every time a client requests authentication.

The AC (3) uses .XSL script to render HTML output, which is done by feeding a XML document to a parsed and prepared for rendering .XSL script. The latter XML document contains all needed information for Web Application Server like user name, password (if one was entered), user IP address, MAC address and NAS-Id. Custom .XSL script must generate initial welcome/login screen so that it embeds all the needed information in a HTML FORM element as hidden elements and POST data not back to the AC, but to the Web Application Server (5). Thereafter the client communicates directly with the Web Application Server.

When the Web Application server has all needed data from the client, it must try to authenticate (6) the client. Authentication is done by the RADIUS server but through the AC. At this step the **shared secret** is used to make the connection between the WAS and the AC. The AC re-sends the authentication request to the RADIUS server (7). Depending on the status, appropriate authentication status must be returned back to the WAS but through the AC (8). In step (9), the Web Application Server knows the client authentication status and reports success or failure back to the client.

 The Web Application Server (WAS) must be configured as a free site in the Walled Garden area.

There is an ability to skip the rendering initial user pages from the .XSL. See the following scheme when the user initial request is redirected to the specified location.

Scheme 2:

The remote authentication method when client with proxy authentication request is re-directed to the external server (WAS):

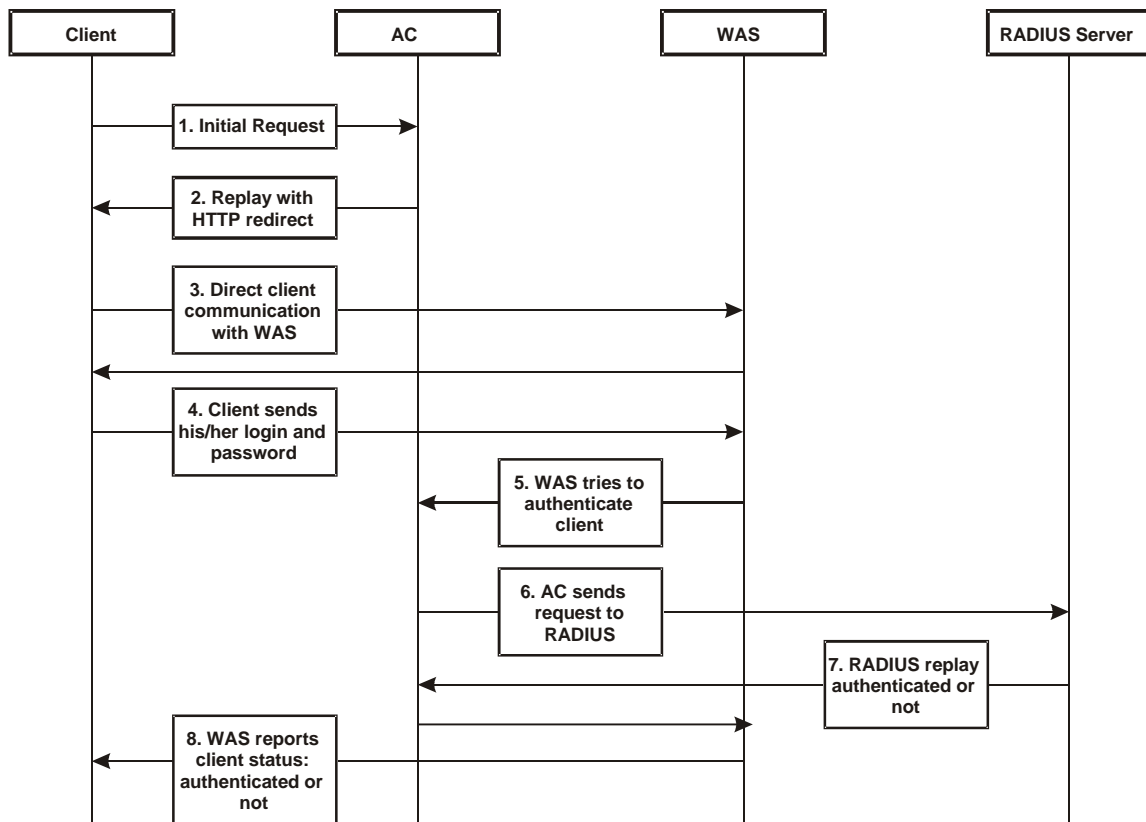



Figure 305 – Client Remote Authentication Scheme (2)

The initial client request (1) can be redirected to the specified location, as **redirection URL** on the Web Application server. In such case the client who wants to authenticate gets the redirection from AC (2). In other words the AC intercepts any access to the Internet via HTTP and redirects the client to the defined **welcome**, or **login** URL on WAS (also see: **User | Pages**). The further actions are the same as described in the **Scheme 1** (Figure 304 – Client Remote Authentication Scheme (1)).

 The WAS location URL under welcome page redirect must be configured as a free site in the Walled Garden area.

To define such redirection URL use the **user | pages** menu. Enable **welcome** page, set the **redirect** setting and specify the redirect location for such authentication process (also see: **User | Pages**).

Parameters Sent to WAS

Parameters that are sent to the external server (WAS) using the remote user authentication method (UAM).

Parameter	Description	Comments
nasid	NAS server ID value	Can be specified under the Network RADIUS Properties menu
nasip	WAN IP address for WAS	Can be changed or specified under the Network Interface menu.
clientip	Client IP address	Cannot be defined manually.
mac	Client MAC address	Cannot be defined manually.
ourl	Initial URL where not authorized client enter to his/her browser and tries to browse. After authentication the client is redirected in this URL	Optional.
sslport	HTTPS port number of AC (by default: 443).	Not configurable.
lang	Parameter "accept-language" from client browser request	Optional.
Lanip	The IP address of the LAN interface the user is connected to.	Can be changed or specified under the Network Interface menu.

In order to logon, log-off or get user status WAS submits POST request to the following URLs:

1. Remote user logon

Script name: pplogon.user

Parameters:

secret shared secret, to protect page from accidental use
 ip IP address of user to be logged on.
 Username Username of the user to be logged on.
 password Password of the user to be logged on.

All parameters are required.

Script call example:

```
https://P720/pplogon.user?secret=sharedSecret&ip=<user_IP_address>&username=userName&password=UserPassword
```

Script produces XML output:

```
<logon>
<status>Ok</status>
<error>0</error>
<description>User logged on.</description>
<replymessage>Hello user!</replymessage>
</logon>
```

Response status and error codes:

status	error	description
OK	0	User is logged on.
Not checked	100	Logon information not checked.
No IP	101	No user IP address supplied.
No username	102	No username supplied.

Disabled	103	Remote authentication is disabled.
Bad secret	104	Incorrect shared secret supplied.
No password	105	No user password.
OK	110	User already logged on.
Failed to authorize	111	Failed to authorize user.
Bad password	112	Incorrect username or/and password.
Network failed	113	Network connection failed.
Accounting error	114	Accounting error.
Too many users	115	Too many users connected.
Unknown authorization error	120	Unknown authorization error.

<replymessage> is RADIUS Reply-Message attribute value. If RADIUS responds with Reply-Message(s), they are added to logon response. If RADIUS does not respond with Reply-Message, <replymessage> attribute is not added to output XML.

2. Remote user log-off

Script name: pplogoff.user

Parameters:

secret	shared secret, to protect page from accidental use
ip	IP address of user to be logged off.
username	Username of the user to be logged off.
mac	AC address of the user to be logged off.

All parameters are required, except the IP and MAC. At least one of IP and MAC addresses should be supplied. If supplied only IP, user is checked and logged off by username and IP. If IP and MAC addresses are supplied, then user is checked and logged off by username, IP and MAC addresses.

Script call example:

```
https://P720/pplogoff.user?secret=sharedSecret&username=UserName&ip=<user_IP_address>
```

Script produces XML output:

```
<logoff>
<status>Ok</status>
<error>0</error>
<description>User logged off.</description>
</logoff>
```

Response statuses and error codes:

status	error	Description
OK	0	User is logged off.
Not checked	100	Logoff information not checked.
No username	102	No username supplied.
Disabled	103	Remote authentication is disabled.
Bad secret	104	Incorrect shared secret supplied.
No IP/MAC	106	No user IP and/or MAC address supplied.
No user by MAC	121	User with supplied MAC address not

		found.
No user by IP	122	User with supplied IP address and username not found.
No user by IP and MAC	123	User with supplied IP, MAC addresses and username not found.
Failed to logoff	131	Failed to logoff user.
Cannot resolve IP	132	Cannot resolve user IP.
Unknown logoff error	140	Unknown logoff error.

3. Remote user status

- Script name: ppstatus.user
- Parameters:
 - secret shared secret, to protect page from accidental use
 - ip IP address of user to get status.
 - username Username of the user to get status.

All parameters are required.

Script call example:

```
https://P720/ppstatus.user?secret=sharedSecret&username=UserName&ip=<user_IP_address>
```

Script produces XML output:

- XML output, when some error occurs:

```
<ppstatus>
  <status>No user by IP</status>
  <error>122</error>
  <description>User with supplied IP address not found.</description>
</ppstatus>
```

Response statuses and error codes:

status	error	description
OK	0	User status is ok.
Not checked	100	Status information not checked.
No IP	101	No user IP address supplied.
No username	102	No username supplied.
Disabled	103	Remote authentication is disabled.
Bad secret	104	Incorrect shared secret supplied
No user by IP	122	User with supplied IP address not found.
No user by IP and username	141	User with supplied IP address and username not found.

- XML output when no errors and user statistics got successfully:

```
<ppstatus>
  <status>Ok</status>
  <error>0</error>
  <description>Got user status.</description>
```

```

<entry id="1">g17</entry>
<entry id="2">192.168.2.117</entry>
<entry id="3">200347C92B63</entry>
<entry id="4">00:00:05</entry>
<entry id="5">3E64C7967A36</entry>
<entry id="6">00:01:10</entry>
<entry id="7">0 bytes</entry>
<entry id="8">0 bytes</entry>
<entry id="9">testlab</entry>
<entry id="10">unlimited</entry>
<entry id="11">unlimited</entry>
<entry id="12">unlimited</entry>
<entry id="13">32 Mbps</entry>
<entry id="14">32 Mbps</entry>
<entry id="15">04:59:55</entry>
<entry id="16">EAP</entry>

```

</ppstatus>

Status detailed information by ID:

id	description
1	User name
2	User IP address
3	User MAC address
4	Session time
5	Session ID
6	User idle time
7	Output bytes
8	Input bytes
9	User WISP name
10	Remaining bytes
11	Remaining output bytes
12	Remaining input bytes
13	Bandwidth upstream
14	Bandwidth downstream
15	Remaining session time
16	Authentication method

Chapter 6 – Customized User page (HTML)

This chapter assist you on configuring BW1254 customized login/logout pages using the BROWAN sample templates. There are coffee bar and general samples. User can also create a personalized login/logout pages based on the provided sample templates.

	Contact with BROWAN if you need the templates samples.
---	--

Set up your customized user page

Step1. Configure and Upload Customized Login/Logout Page files

Login BW1254 as super administrator and go to **User | Customized UAM**.

In order to configure BW1254 using the customized login/logout page, Customize Page status must be set to enable.

To enable Customized Page, edit the Customize page status(**User | Customized UAM**) and set to **Enabled**. See the diagram below:

Customized UAM		
Description	Status	Action
Use SSL	disabled	Edit
Customize Page	<input checked="" type="radio"/> Enabled <input type="radio"/> Disabled	Save Cancel

Figure 306 – enable customize page status

Customized UAM		
Description	Status	Action
Use SSL	disabled	Edit
Customize Page	enabled	Edit
Pop Logout Page	enabled	Edit
Logout Page width size: 350 Logout Page Height size: 390		Edit
Use External Page	disabled	Edit
Update HTML Files		
Description	Action	
Delete all uploaded HTML and images files!	Delete	
Upload HTML and image files!	Upload	
See example login html page here and See example logout html page here		
Uploaded File List		

Figure 307 – customize page status is enabled

To start to upload the customized template files, click the upload button. (We will use the coffee bar style template files that BROWAN provided for this demonstration).

After clicking the upload button, an **Update Custom UAM Files** screen will appear. (See diagram below).

Customized UAM		
Description	Status	Action
Use SSL	disabled	Edit
Customize Page	enabled	Edit
Pop Logout Page	enabled	Edit
Logout Page width size: 350 Logout Page Height size: 390		Edit
Use External Page	disabled	Edit
Update Custom UAM Files		
Login File	<input type="text"/>	Browse..
Logout File	<input type="text"/>	Browse..
Additional file 01	<input type="text"/>	Browse..
Additional file 02	<input type="text"/>	Browse..
Additional file 03	<input type="text"/>	Browse..
Additional file 04	<input type="text"/>	Browse..
Additional file 05	<input type="text"/>	Browse..
Additional file 06	<input type="text"/>	Browse..
Additional file 07	<input type="text"/>	Browse..
Additional file 08	<input type="text"/>	Browse..
Additional file 09	<input type="text"/>	Browse..
Additional file 10	<input type="text"/>	Browse..
Upload Cancel		

Figure 308 – upload files

Enter the physical path and filename of the coffee template files, or click the “**browse**” button to search the coffee template files are located.

	<p><u>The first two items are for login.html and logout.html files only.</u> Additional files are for CSS and image files, such as jpg, gif, png and etc.</p>
---	--

Update Custom UAM Files		
Login File	D:\Data\P720\cd_content\Examples(HTML)\coffee\login.htm	Browse..
Logout File		Browse..
Additional file 01		Browse..
Additional file 02		Browse..
Additional file 03		Browse..
Additional file 04		Browse..
Additional file 05		Browse..
Additional file 06		Browse..
Additional file 07		Browse..
Additional file 08		Browse..
Additional file 09		Browse..
Additional file 10		Browse..
<input type="button" value="Upload"/> <input type="button" value="Cancel"/>		

Figure 309 – upload login.html

After entering all the template files, press upload button to start the uploading files to BW1254.

	<p>Only ten Additional files can be uploaded at one time. To upload more additional file, repeat the same upload process in step 2-4, but please be aware of the first two items are only for login.html and logout.html files. Image files can only be uploaded to Additional file fields</p>
--	--

Update Custom UAM Files		
Login File	D:\Data\P720\cd_content\Examples(HTML)\coffee\login.htm	Browse..
Logout File	D:\Data\P720\cd_content\Examples(HTML)\coffee\logout.htm	Browse..
Additional file 01	D:\Data\P720\cd_content\Examples(HTML)\coffee\images\but.gif	Browse..
Additional file 02	D:\Data\P720\cd_content\Examples(HTML)\coffee\images\but_ove	Browse..
Additional file 03	D:\Data\P720\cd_content\Examples(HTML)\coffee\images\icon2.jp	Browse..
Additional file 04	D:\Data\P720\cd_content\Examples(HTML)\coffee\images\icon.gif	Browse..
Additional file 05	D:\Data\P720\cd_content\Examples(HTML)\coffee\images\line.gif	Browse..
Additional file 06	D:\Data\P720\cd_content\Examples(HTML)\coffee\images\login_0	Browse..
Additional file 07	D:\Data\P720\cd_content\Examples(HTML)\coffee\images\login_0	Browse..
Additional file 08	D:\Data\P720\cd_content\Examples(HTML)\coffee\images\login_0	Browse..
Additional file 09	D:\Data\P720\cd_content\Examples(HTML)\coffee\images\login_0	Browse..
Additional file 10	D:\Data\P720\cd_content\Examples(HTML)\coffee\images\login_0	Browse..
<input type="button" value="Upload"/> <input type="button" value="Cancel"/>		

Figure 310 – upload other files

Once all files are uploaded successfully, a list of Uploaded File List will show.

Update HTML Files	
Description	Action
Delete all uploaded HTML and images files!	Delete
Upload HTML and image files!	Upload
See example login html page here and See example logout html page here	
Uploaded File List	
aclogin.html	
aclogout.html	
but.gif	
but_over.gif	
icon.gif	
icon2.jpg	
line.gif	
login_01.jpg	

Figure 311 – files have been uploaded

Verify if all files are uploaded successfully

Step2. Configure the pixels of logout window.

The README file in each template directory contains the information of the pixels settings for the logout page. Enter the width size and height size setting of logout page and press the **Save** button. E.g. the coffee bar template, the suggested size of logout page is 760 x 601.

Customized UAM		
Description	Status	Action
Use SSL	disabled	Edit
Customize Page	enabled	Edit
Pop Logout Page	enabled	Edit
Logout Page width size: <input type="text" value="760"/>	Logout Page Height size: <input type="text" value="601"/>	Save Cancel
Use External Page	disabled	Edit

Figure 312 – set the pixels of logout window

Step3. Everything is ready

Now, any users that access the internet via the BW1254 will see the new personalized login and logout pages.

Let’s look at the new appearance of login and logout page based on the coffee bar template.

	Make sure your computer is in the same network with BW1254 and enter https://device IP address for the customized page test.
---	--



Figure 313 – example of coffee bar login page

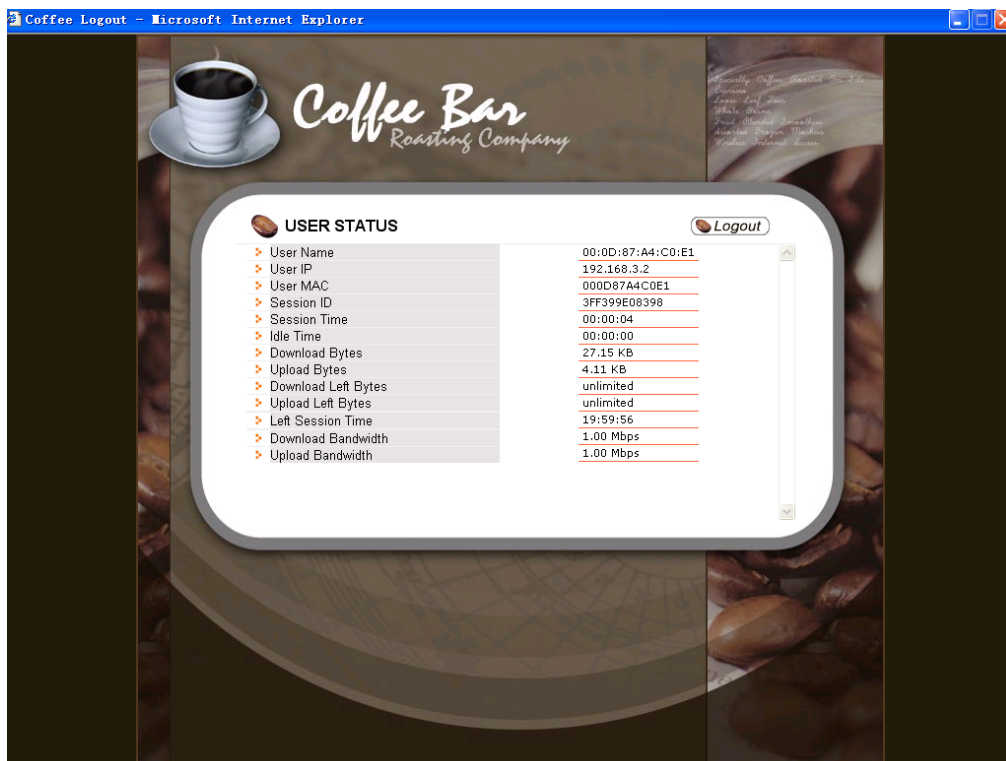

Figure 314 – example of coffee bar logout page

FAQ

1. **Question:** How to add some links that could be accessed without authentication?

Answer: These authentication-free sites for users are so called “walled garden” area. Please refer to the user’s guide to do the relating settings.

2. **Question:** How to hide the user login session information from my customers?

Answer: You can find these set of html code in logout.html we provided:

```
<td width="265" valign="top"><iframe src="logout.user?cmd=status" width="250"
height="240" marginwidth="0" marginheight="0" scrolling="yes"
frameborder="0"></iframe></td>
```

These set of code uses an embedded window to show the session data in logout window. Comment them with HTML comments language “<!--“ and “!-->” will hide the session data in logout window.

3. **Question:** If I don’t want the logout window to pop-up to users, how could I do?

Answer: Please login BW1254 and go to **User | Customized UAM** to disable “pop logout page.”

4. **Question:** If I close the logout window, how can I logout?

Answer: 1. just un-plug your wireless card, or un-plug your network cable if you use a wired card.
2. Open a browser window, and input the URL: “logout.usr”, then you will be redirect to logout window.

Appendix

A) Specification

Wireless		
Standard	IEEE 802.11a/b/g/n	
Data Rate	802.11n : 300,270,240,200,180,150,120,100,54,48,36,24,18,12,11,9,6,5.5,2,1Mbps 802.11a : 54,48,36,24,18,12,9,6Mbps 802.11g : 54,48,36,24,18,12,9,6Mbps 802.11b : 11,5.5,2,1Mbps (auto fallback)	
Transmit Power (adjustable RF power)	Max. 27 dBm ± 2dBm (Maximum power will vary by channel, rate and regulatory domain)	
Antennas	4 Dual-band Dipole Antennas with RP-SMA plug connector	
Encryption	WPA/WPA2 (TKIP and CCMP-AES) , Dynamic/static 64bits and 128bits WEP	
DynamicBridge	Up to 31 bridge links	
Interface		
LAN	10/100/100Mb Ethernet, auto sensing, RJ-45	
Console	1 for RJ-45 interface	
Management		
Interfaces	HTTPs, Secure Telnet(SSHv2), SNMP	
Software Update	Remote software update via HTTPs	
Reset	H/W and S/W restore factory default	
Physical Specification		
Dimension	195 mm x 165 mm x 35 mm	
Weight	790±10g	
Environment Specification		
	Temperature	Humidity
Operating	0 to +50°C	95%, non-condensing
Power Supply		
POE	IEEE802.3at, IEEE802.3af-2003 compliance	
Power adaptor	External power supply, input: 100-240 VAC, 50-60Hz and output: 48VDC	
LEDs		
4 LEDs	Power, MODE, Ethernet, WLAN1, WLAN2	
Warranty		
1 years		
Package Contents		
▪ BW1254 Indoor Access Point	▪ Ethernet patch cable	
▪ Screw Bag	▪ 4xAntennas	
▪ power supply(48VDC)	▪	

Related Products

Controllers:	BG-6020G/G-4200 Public Access Controller	
Access Points:	BW1253 single radio 802.11a/b/g/n hotspot indoor access point	BW2251 dual radio 802.11a/b/g/n hotspot outdoor access point

B) Factory Defaults for the BW1254

Network Interface Configuration Settings

Operation Mode

Mode AP

Network | Interface
AP Mode (Default)

Interface br0
 Type LAN
 IP Address 192.168.2.2
 Netmask 255.255.255.0
 Gateway 0.0.0.0

AP Router Mode

Interface eth0
 Type WAN
 IP Address 192.168.2.2
 Netmask 255.255.255.0
 Gateway 192.168.2.1

Network | RADIUS Properties

RADIUS Retries 5
 RADIUS Timeout 2
 NAS Server ID -
 User Session Timeout 72000
 User Accounting Update Interval 600
 User Accounting Update Retry 60
 User Idle Timeout 900
 Bandwidth Up 512 Kbits
 Bandwidth Down 512 Kbits

Network | RADIUS Servers

Name DEFAULT (default)
 Type Authentication
 IP Address 0.0.0.0
 Port 1812
 Secret password (case sensitive)
 Type Accounting
 IP Address 0.0.0.0

Port	1813
Secret	secret (case sensitive)
User Password Md5sum Secret	disabled

Network | DHCP Server**DHCP Server**

Status	Disabled
IP Address from	192.168.3.2
IP Address to	192.168.3.254
Netmask	255.255.255.0
Gateway	192.168.3.1
WINS Address	0.0.0.0
Lease Time (seconds)	86400
DNS address	0.0.0.0
DNS Secondary address	0.0.0.0

Network | DNS (only for AP router mode)

Type	Primary
IP Address	0.0.0.0
Type	Secondary
IP Address	0.0.0.0

Network | Static Route (only for AP router mode)

No routes are defined on system.

WISP

No WISP defined on system.

Wireless | Basic**WLAN1**

Regulatory Domain	FCC
Channels	11(static)
Wireless Band	2.4GHz(11n HT20)
Total Output Power(EIRP)	14dBm
RTS Threshold	2347bytes
Layer2 Isolation	disabled
Operation Mode	AP

WLAN2

Regulatory Domain	FCC
Channels	36(static)
Wireless Band	5GHz(11n HT20)
Total Output Power(EIRP)	13dBm
RTS Threshold	2347bytes
Layer2 Isolation	disabled
Operation Mode	AP

Wireless | Advanced**WLAN1**

SSID	BW1254-11ng
------	-------------

Hidden SSID	Disabled
Security	Disabled
WLAN2	
SSID	BW1254-11na
Hidden SSID	Disabled
Security	Disabled

Wireless | MSSID

No multiple BSSID entry

Wireless | WEP

Status	Disabled
Key1 to Key4	aaaaa

Wireless | MAC ACL

ACL Policy	Disabled
------------	----------

User Settings

User | Customized UAM (Only for AP router mode)

Use SSL	Disabled
Customize Page	Disabled

User | Station Supervision

Interval	20
Failure count	3

User | WISP(Only for AP router mode)

Domain Policy	Username@domain
No WISP defined on system	

System Settings

System | Administrator

Super administrator:	Username: admin (case sensitive) Password: admin01 (case sensitive)
----------------------	--

System | SNMP

SNMP Service	Enabled
Readonly Community	public
Readwrite Community	private
Default Trap Community	public
There are no SNMP traps on system.	

System | Telnet

Telnet Service	Enabled
SSH Service	Enabled

System | NTP

NTP Service Disabled
 Time Zone GMT-12:00
 There are no NTP Server settings on system.

System | Time

Date 1970/01/01

System | System Log

Remote Log Status Disabled
 Host IP 192.168.2.1
 Log Level info
 Local Log Status Enabled
 Log Limit(bytes) 102400
 Log Level info

C) Location ID and ISO Country Codes

This list states the **country names** (official short names in English) in alphabetical order as given in ISO 3166-1 **and** the corresponding **ISO 3166-1-alpha-2 code elements**.

It lists 239 official short names and code elements.

Location ID	Country	Location ID	Country
AF	Afghanistan	LI	Liechtenstein
AL	Albania	LT	Lithuania
DZ	Algeria	LU	Luxembourg
AS	American Samoa	MO	Macao
AD	Andorra	MK	Macedonia, the former Yugoslav republic of
AO	Angola	MG	Madagascar
AI	Anguilla	MW	Malawi
AQ	Antarctica	MY	Malaysia
AG	Antigua and Barbuda	MV	Maldives
AR	Argentina	ML	Mali
AM	Armenia	MT	Malta
AW	Aruba	MH	Marshall islands
AU	Australia	MQ	Martinique
AT	Austria	MR	Mauritania
AZ	Azerbaijan	MU	Mauritius
BS	Bahamas	YT	Mayotte
BH	Bahrain	MX	Mexico

BD	Bangladesh	FM	Micronesia, federated states of
BB	Barbados	MD	Moldova, republic of
BY	Belarus	MC	Monaco
BE	Belgium	MN	Mongolia
BZ	Belize	MS	Montserrat
BJ	Benin	MA	Morocco
BM	Bermuda	MZ	Mozambique
BT	Bhutan	MM	Myanmar
BO	Bolivia	NA	Namibia
BA	Bosnia and Herzegovina	NR	Nauru
BW	Botswana	NP	Nepal
BV	Bouvet island	NL	Netherlands
BR	Brazil	AN	Netherlands Antilles
IO	British Indian ocean territory	NC	New Caledonia
BN	Brunei Darussalam	NZ	New Zealand
BG	Bulgaria	NI	Nicaragua
BF	Burkina Faso	NE	Niger
BI	Burundi	NG	Nigeria
KH	Cambodia	NU	Niue
CM	Cameroon	NF	Norfolk island
CA	Canada	MP	Northern Mariana islands
CV	Cape Verde	NO	Norway
KY	Cayman islands	OM	Oman
CF	Central African republic	PK	Pakistan
TD	Chad	PW	Palau
CL	Chile	PS	Palestinian territory, occupied
CN	China	PA	Panama
CX	Christmas island	PG	Papua new guinea
CC	Cocos (keeling) islands	PY	Paraguay
CO	Colombia	PE	Peru
KM	Comoros	PH	Philippines
CG	Congo	PN	Pitcairn
CD	Congo, the democratic republic of the	PL	Poland
CK	Cook islands	PT	Portugal
CR	Costa Rica	PR	Puerto Rico
CI	Côte d'ivoire	QA	Qatar
HR	Croatia	RE	Réunion
CU	Cuba	RO	Romania
CY	Cyprus	RU	Russian federation
CZ	Czech republic	RW	Rwanda
DK	Denmark	SH	Saint Helena

DJ	Djibouti	KN	Saint Kitts and Nevis
DM	Dominica	LC	Saint Lucia
DO	Dominican republic	PM	Saint Pierre and Miquelon
EC	Ecuador	VC	Saint Vincent and the grenadines
EG	Egypt	WS	Samoa
SV	El Salvador	SM	San Marino
GQ	Equatorial guinea	ST	Sao tome and Principe
ER	Eritrea	SA	Saudi Arabia
EE	Estonia	SN	Senegal
ET	Ethiopia	SC	Seychelles
FK	Falkland islands (malvinas)	SL	Sierra Leone
FO	Faroe islands	SG	Singapore
FJ	Fiji	SK	Slovakia
FI	Finland	SI	Slovenia
FR	France	SB	Solomon islands
GF	French Guiana	SO	Somalia
PF	French Polynesia	ZA	South Africa
TF	French southern territories	GS	South Georgia and the south sandwich islands
GA	Gabon	ES	Spain
GM	Gambia	LK	Sri Lanka
GE	Georgia	SD	Sudan
DE	Germany	SR	Suriname
GH	Ghana	SJ	Svalbard and Jan Mayan
GI	Gibraltar	SZ	Swaziland
GR	Greece	SE	Sweden
GL	Greenland	CH	Switzerland
GD	Grenada	SY	Syrian Arab republic
GP	Guadeloupe	TW	Taiwan, province of china
GU	Guam	TJ	Tajikistan
GT	Guatemala	TZ	Tanzania, united republic of
GN	Guinea	TH	Thailand
GW	Guinea-Bissau	TL	Timor-leste
GY	Guyana	TG	Togo
HT	Haiti	TK	Tokelau
HM	Heard island and McDonald islands	TO	Tonga
VA	Holy see (Vatican city state)	TT	Trinidad and Tobago
HN	Honduras	TN	Tunisia
HK	Hong Kong	TR	Turkey
HU	Hungary	TM	Turkmenistan
IS	Iceland	TC	Turks and Caicos islands
IN	India	TV	Tuvalu

ID	Indonesia	UG	Uganda
IR	Iran, Islamic republic of	UA	Ukraine
IQ	Iraq	AE	United Arab emirates
IE	Ireland	GB	United kingdom
IL	Israel	US	United states
IT	Italy	UM	United states minor outlying islands
JM	Jamaica	UY	Uruguay
JP	Japan	UZ	Uzbekistan
JO	Jordan	VU	Vanuatu
KZ	Kazakhstan		Vatican city state see holy see
KE	Kenya	VE	Venezuela
KI	Kiribati	VN	Viet nam
KP	Korea, democratic people's republic of	VG	Virgin islands, British
KR	Korea, republic of	VI	Virgin islands, u.s.
KW	Kuwait	WF	Wallis and Futuna
KG	Kyrgyzstan	EH	Western Sahara
LA	Lao people's democratic republic	YE	Yemen
LV	Latvia	YU	Yugoslavia
LB	Lebanon		Zaire see Congo, the democratic republic of the
LS	Lesotho	ZM	Zambia
LR	Liberia	ZW	Zimbabwe
LY	Libyan Arab Jamahiriya		