

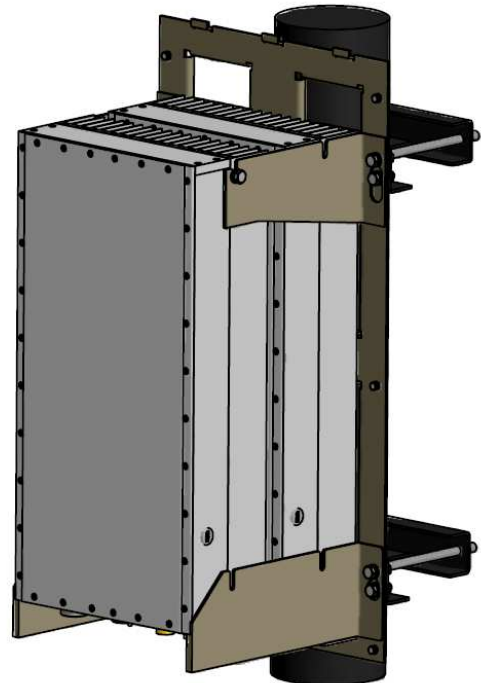

mBSC081921-12
ISSUE 2

mBSC081921-12 Multi-Band, Multi-Standard, Multi-Carrier Coverage System

Operation Manual



COPYRIGHT

This document is the Operation Manual for Bravo Tech Inc. mBSC system. Bravo Tech Inc. reserves the right to change the contents without prior notice. No part of this document may be reproduced or utilized.
© 2009, Bravo Tech Inc, All Rights Reserved

REVISION HISTORY



Issue No.	Description	Date
1	Initial Draft	Dec. 15, 2009
2	Update the specification	Jan. 18, 2010

TABLE OF CONTENTS

Content	Page
1 Introduction	4
2 Thoery of operation	4
2.1 System Overview	4
2.2 Basic System Components.....	4
2.3 Host Unit Description.....	4
2.3.1 Basic Functions of HU	5
2.3.2 HU Interface Ports Description	5
2.4 Remote Unit Description.....	6
2.4.1 Basic Functions of RU	8
2.4.2 RU Interface Ports Description	8
2.5 Specifications	9
3 Network Management system	12
3.1 Software Installation	13
3.2 System Start-Up Procedure with NMS	13
3.3 Read and Edit the current system setting parameters	19
3.4 Read and Modify the System Gain Budget	20
3.5 Check Alarm Status for the system	21
3.6 Check the Major performance for the system.....	22
4 antenna Mount environment.....	23
5 fcc warning.....	23
6 customer Contact information.....	23
Figure 2-1. System Overview Structure.....	4
Figure 2-2. Host Unit	5
Figure 2-3. User Interface of Host Unit.....	6
Figure 2-4. 3 Remote Unit Assembly Without Solar Shell	7
Figure 2-5. 3 Remote Unit Assembly With Solar Shell	8
Figure 2-6. User Interface of Remote Unit.....	9
Figure 3-1. User Login Window.....	13
Figure 3-2. Advanced User Login Window	13

Content	Page
Figure 3-3. Network Management System Main Window	14
Figure 3-4. Configuration of IP Address	14
Figure 3-5. System Configuration Window	15
Figure 3-6. Define the District	15
Figure 3-7. Reult window after Defining District	16
Figure 3-8. Add the Host Unit in the System configuration	16
Figure 3-9. Result Window after adding HU	17
Figure 3-10. Add the Remote Unit below the Host Unit Tree	17
Figure 3-11. Completion of the System Configuration	18
Figure 3-12. Read the current setting for teh system	19
Figure 3-13. Modify the parameters for the system	19
Figure 3-14. Modify the parameters for the system	20
Figure 3-15. Read the current Alarm Status	21
Figure 3-16. Change the Alarm Setting	21
Figure 3-17. Check the system performance	22
Table 2-1. Remote Unit User Interface	6
Table 2-2. Remote Unit User Interface	9
Table 2-3. mBSC System specifications	9
Table 3-1. Rule for numbering the Equipment Code	18

SAFETY CAUTIONS

-  **Danger:** *Danger is used to indicate the presence of a harzard that will cause server personal injury or substantial property damage if the harzard is not abvoided.*
-  **Warning:** *Warning is used to indicate the presence of a harzard that can cause server personal injury or substantial property damage if the harzard is not abvoided.*
-  **Caution:** *Caution is used to indicate the presence of a harzard that will or can cause minor personal injury or substantial property damage if the harzard is not abvoided.*

Glossary and Acronyms

The acronyms and abbreviations used in this manual are detailed in the following list.

mBSC	Multi-Band, Multi-System, Multi-Carrier
HU	Host Unit
RU	Remote Unit
FIU	Fiber optic Interface Unit
BIU	Base station Interface Unit
RCU	Remote Control Unit
PSU	Power Supply Unit
NMS	Network Management System

1 INTRODUCTION

This document provides the basic description, application and configuration for Bravo Tech Inc. mBSC081921-12 system. Throughout this publication,

2 THOERY OF OPERATION

2.1 System Overview

mBSC081921-12 is the economic and convenient coverage solution of DAS system which has a fiber transport. The system consists of HU (Host unit) and RU (Remote unit). The HU is mounted in a 19" rack and are intend for use indoor environment. The RU can work in outdoor environment. The output power of the RU is 40W. The transport between HU and RU is fiber optic. The downlink and uplink optical signal are duplex so there is only one fiber needed.

2.2 Basic System Components

The basic components of Bravo Tech Inc. mBSC system and their functions are shown in Figure 2-1. A basic mBSC system consists of a Host Unit (HU) and a Remote Unit (RI). The Host unit has multiple slot assembly that mounts in a standard equipment rack. The RU consists of multiple electronic and optical modules for supporting multiple Standards, which mounts in outdoor wall or pole. Control and monitoring functions are provided by the Network Management System (NMS).

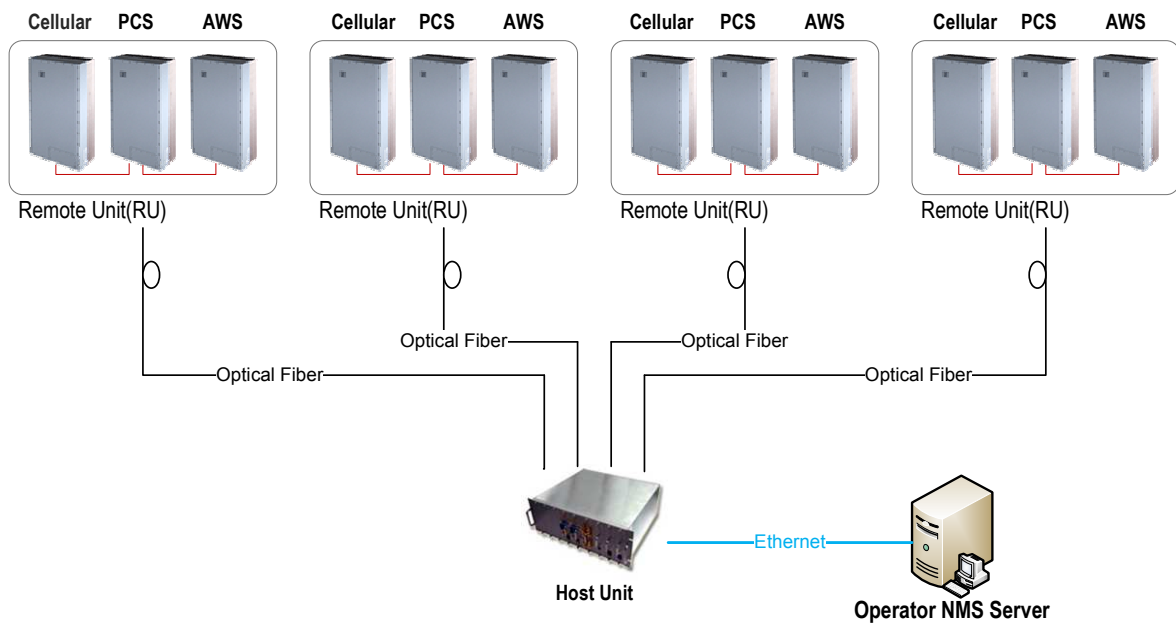

Figure 2-1. System Overview Structure

2.3 Host Unit Description

The HU, shown in Figure 2-3, consists of RF conditioning units (BIU) and optical TRX modules (FIU). HU combines the 3 band downlink RF signals from BTS and converts them to optical signal. At the same time, HU converts the uplink optical signals to RF signals and splits and filters out 3 band RF signals.

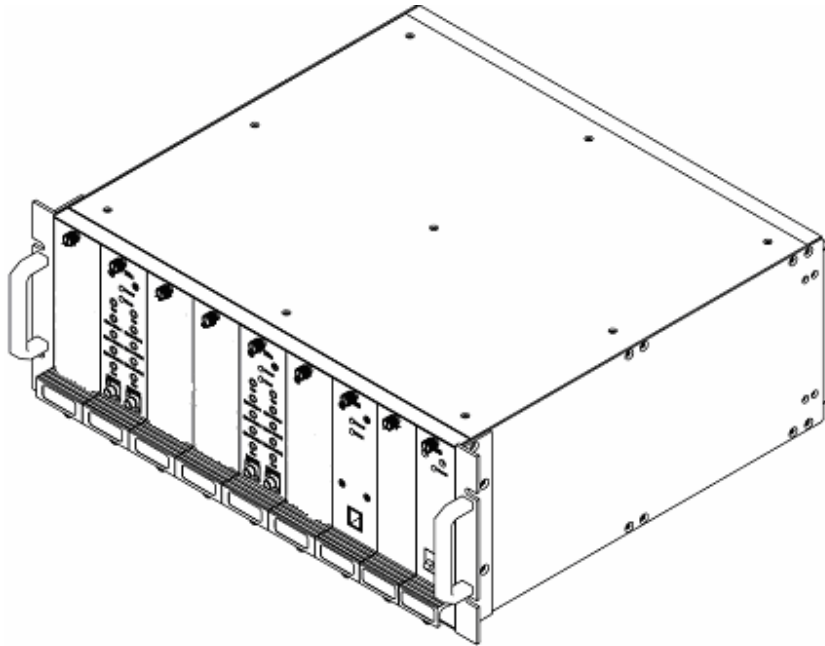

Figure 2-2. Host Unit

2.3.1 Basic Functions of HU

HU provides the following basic functions.

- **BIU** (Base station Interface Unit): RF interface module with Base Station
- **FIU** (Fiber optic Interface Unit): Optical TRX module. Convert RF signals to Optic signals
- **RCU** (Remote Control Unit): Ethernet Interface module for Network Management Software
- **PSU** (Power Supply Unit): Power Supply unit for providing DC power to BIU, FIU and RCU module

2.3.2 HU Interface Ports Description

Each interface port, shown in Figure 3, is described in below Table 1.

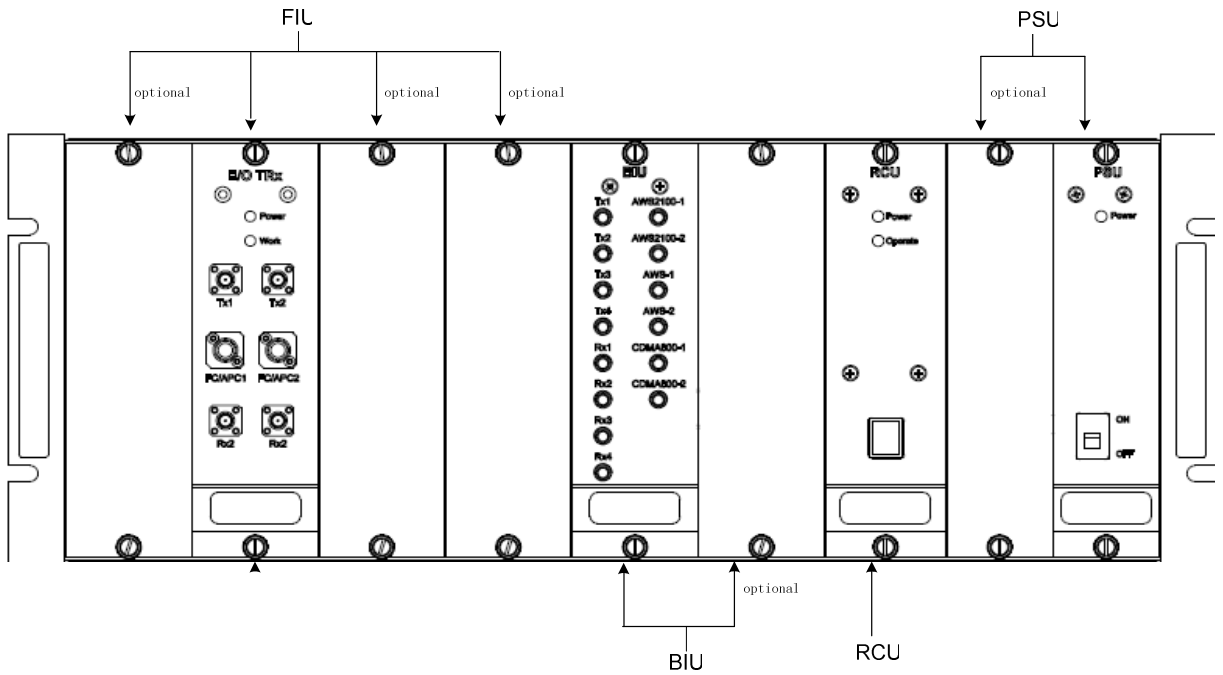

Figure 2-3. User Interface of Host Unit

Table 2-1. Host Unit User Interface

Board Name	Port Name	Description	Remark
FIU	TX1, TX2	Downlink interface ports to be connected to BIU	RF signal
	RX1, RX2	Uplink interface ports to be connected to BIU	RF signal
	FC/APC1, FC/APC2	Fiber optic interface ports to be connected to RU	Optical signal
	E911-800-1, E911-800-2	The cellular band coupling uplink signal for LMU	RF signal
	E911-1900-1, E911-1900-1	The PCS band coupling uplink signal for LMU	RF signal
	E911-2100-1, E911-2100-1	The AWS band coupling uplink signal for LMU	RF signal
BIU	TX1, TX2, TX3, TX4	The combined downlink signal to FIUs	RF signal
	RX1, RX2, RX3, RX4	The combined uplink signal from FIUs	RF signal
	AWS-1, AWS-2	The interface to AWS band BTS TX/RX ports	RF signal
	PSC-1, PCS-2	The interface to PCS band BTS TX/RX ports	RF signal
	Cellular -1, Cellular-2	The interface to cellular band BTS TX/RX ports	RF signal

2.4 Remote Unit Description

The Remote Unit, shown in Figure 2-5 and Figure 2-6, consists of optical module (O/E), downlink power amplifier, LNA and duplexer. Optical module converts the downlink optical signal from the HU and splits the RF signal to 3 RU. It also converts the uplink RF signal to optical signal and sends it to

the HU. Each optical module can support 3 RU in different band. The 3 RU were assembled together as a whole.

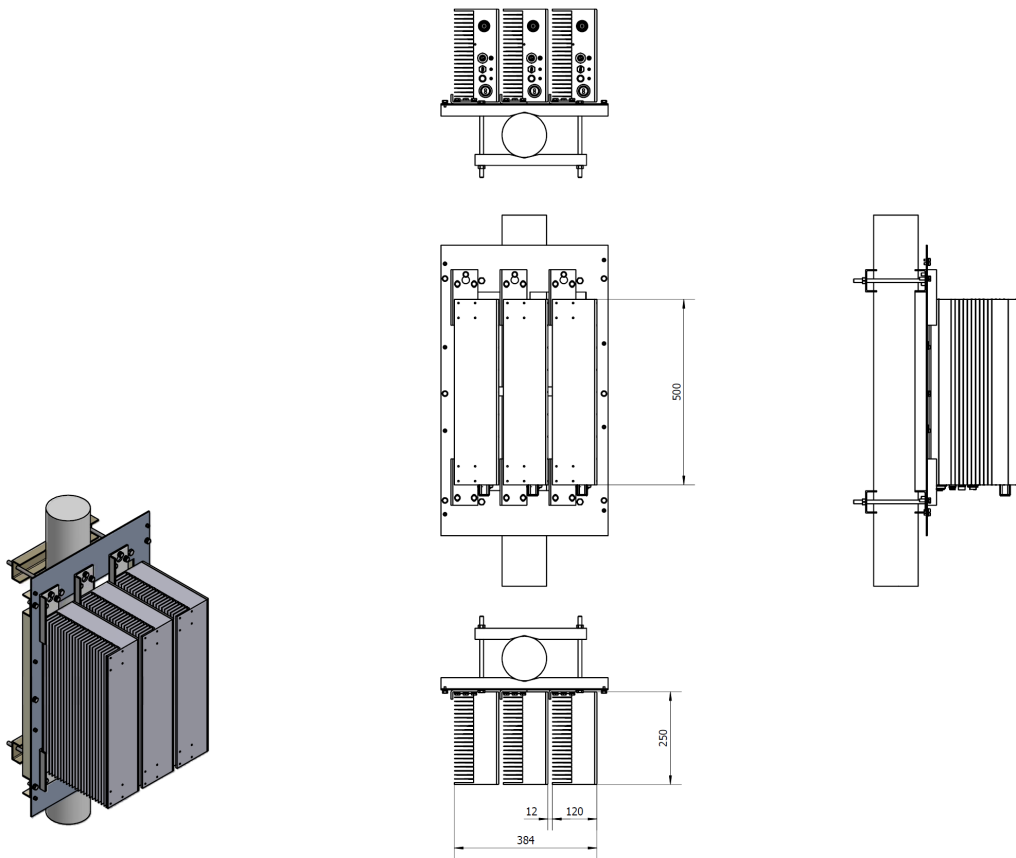

Figure 2-4. 3 Remote Unit Assembly Without Solar Shell

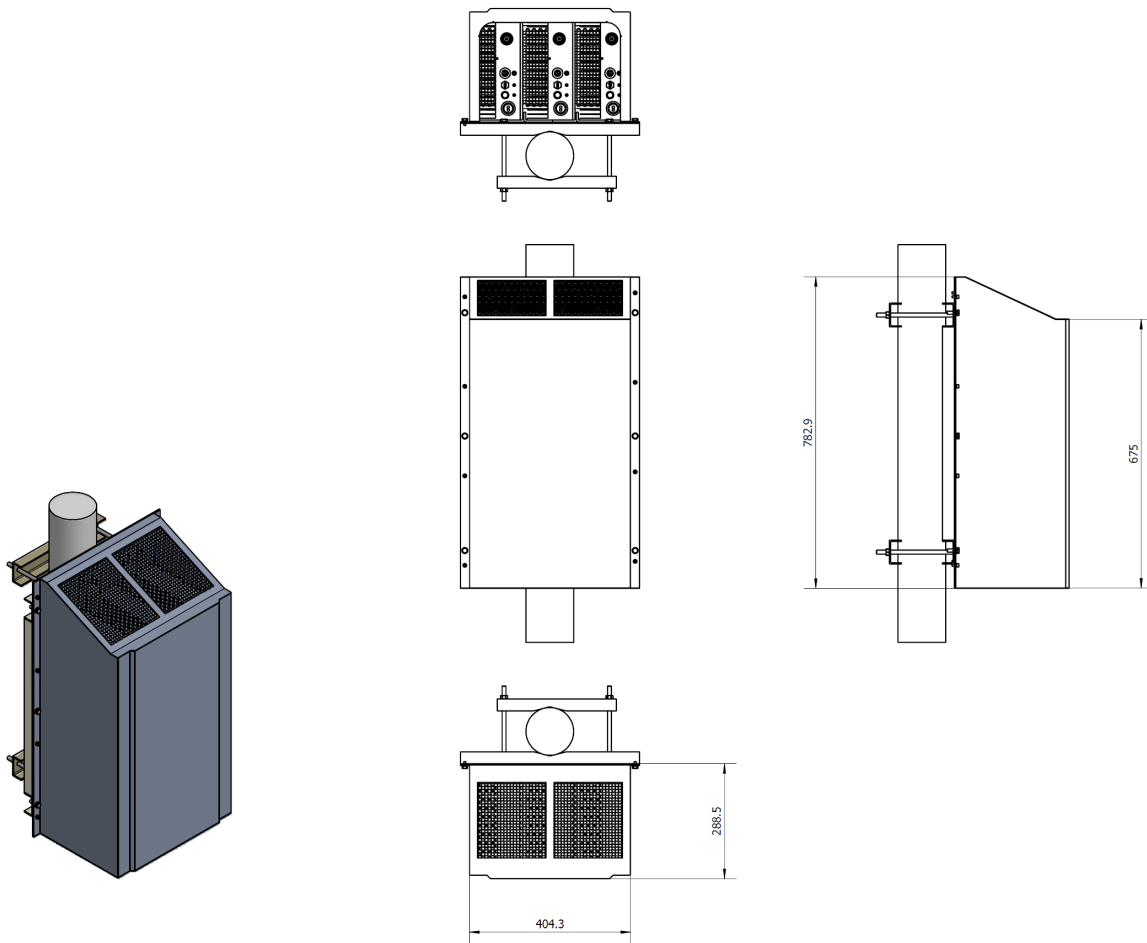

Figure 2-5. 3 Remote Unit Assembly With Solar Shell

2.4.1 Basic Functions of RU

The RU provides the following functions:

- Convert downlink optic signal to RF signal and uplink RF signal to optic signal
- Booster the forward RF signal from HU to high power level (Max output: 40W / RU)
- Amplify the uplink signal from antenna to improve the system receive sensitivity

2.4.2 RU Interface Ports Description

Each interface port of Remote Unit, shown in Figure 2-7, is described in below Table 2-2.

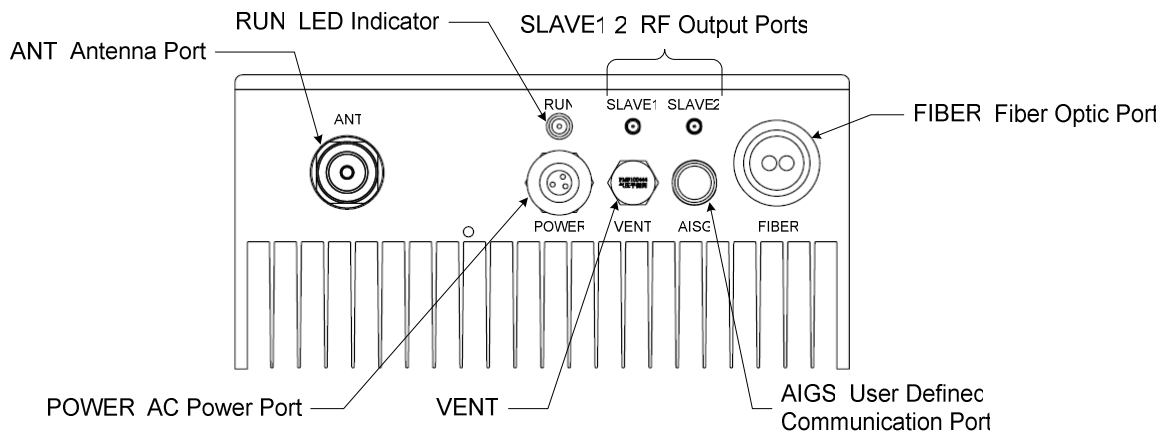

Figure 2-6. User Interface of Remote Unit

Table 2-2. Remote Unit User Interface

Label Name	Description
ANT	Interface port for Antenna Feed line
RUN	LED indicator for normal or critical fault status of RU. Normal: Green ON, Critical fault: Red ON
SLAVE 1, 2	RF output port to provide the input signal to Slave Remote unit when Dual or Triple Band application
FIBER	Fiber Optic Cable interface port for combined downlink and uplink signal
POWER	Interface port for the AC 220V power cable
AISG	User Defined Interface port for External Alarm. (Debug port for the default)
VENT	Port for the balance of the pressure inside and outside of the enclosure

2.5 Specifications

The specifications for the mBSC system are listed in Table 2-3.

Table 2-3. mBSC System specifications

System Specification	Downlink			Uplink		
	Cellular	PCS	AWS	Cellular	PCS	AWS
Frequency (MHz)	869 to 894 MHz	1930 to 1990 MHz	2110 to 2155 MHz	824 to 849 MHz	1850 to 1910 MHz	1710 to 1755 MHz
Max Gain (for 0 to 10dB optical loss)	43±1dB			17±1dB		
Adjustable Gain Range	20dB			20dB		
Adjustable Step	0.5dB			0.5dB		
Input power range	0-20dBm for BIU-A; 26-46dBm for BIU-B					
Output Power	+46dBm±1dB			-8dBm±1dB		
Max No Damage Input Power	+26dBm for BIU-A +47dBm for BIU-B			+10dBm		
Pass Band Ripple	≤±1.5 dB			≤±1.5 dB		
Noise Figure (@17dB Gain)	N/A			≤ 2.5dB (0 dB optical loss) ≤ 2.8dB (5 dB optical loss) ≤ 3.0dB (10 dB optical loss)		
Noise Figure	N/A			≤5dB (0-10dB optical loss)		

System Specification	Downlink			Uplink		
	Cellular	PCS	AWS	Cellular	PCS	AWS
(@6dB Gain)						
Dynamic range	N/A			60dB		
System delay	≤ 500ns					
Optic Link Budget	10dB (full performance) , 15dB (derate)					
Optic Wavelength	1310/1550nm					
ALC range	6dB			30dB		
VSWR	≤1.5					
Antenna Port	7/16 DIN female					
Optical connector	FC/APC (HU) ; LC/PC (RU)					
Power Supply	DC -48V (HU) ; AC 110/220V (RU)					
Waterproof	IP40 (HU) ; IP65 (RU)					
NMS	Support SNMPv2					

BIU Specification	Downlink			Uplink		
	Cellular	PCS	AWS	Cellular	PCS	AWS
Frequency (MHz)	869 to 894 MHz	1930 to 1990 MHz	2110 to 2155 MHz	824 to 849 MHz	1850 to 1910 MHz	1710 to 1755 MHz
Max No of Plug-in module	6 for low power (BIU-A) 3 for High power (BIU-B)					
Input power level	0 ~ 20dBm for low power module, 26-46dBm for high power module					
Input/Output VSWR	≤ 1.5					
Temperature of operation	-40°C ~ +60°C					
Power supply	DC -48V					
Current	< 1A @ Full power output					
Weight	17Kg					
Dimensions (H x W x D)	177mm x 485mm x 445mm					
MTBF	100 , 000 Hours					
No of BTS interface/per band	2					
Max No of divided output	4/per module					
RF Port	SMA					
NMS Interface	Ethernet					

Optical module (FIU) specification	Specification	Notes
Optical Wavelength	1310 ± 20nm (HU) 1550 ± 20nm (RU)	
Optical Output Power	4dBm ± 2dB	
Optical Input Power	-18 ~ 6dBm	
Tx Alarm	optical output power < -3dBm	Software setting
Rx Alarm	Optical input power < -15dBm	Software setting
WDM	Embedded	
Fiber Connector	FC/APC	
Frequency	700 ~ 2200MHz	
Link Gain	0 ± 2dB (Uplink , Downlink) @ 0 ~ 10dB fiber loss	Default
Flatness	≤ 1dB in each band	
VSWR	≤ 1.4	

Optical module (FIU) specification	Specification	Notes
Third-order Intermodulation	$\leq -65\text{dBc}$ (0dBm/2 tone)	
Noise	$\leq -134\text{dBm/Hz}$ (RF Gain: 0dB)	
RF Isolation	$\geq 60\text{dB}$	
Spurious	$\leq -60\text{dBm} / 100\text{KHz}$ (100MHz ~ 3GHz)	
Delay	60ns	
Temperature of operation	-20 ~ +65°C	
Current	$\leq 200\text{mA}$ /per module (+12V Power Supply)	
Power Supply	DC +5.6V ~ +15V , Power Consumption: < 2.5W	
Communication Interface	RS232 and RS485 Interface Data Rate: Software Setting	

NMS Specification	Specification	Notes
Max No of port	30 (manage 30 BIU rack or FIU rack , 1080 Remote unit)	
SNMP based management	yes	
Web browser	yes	
Real time alarm display	yes	
Display various system level values	yes	Voltages , RF power etc.
Remote download	yes	

Cellular Band Remote Unit Specification		Downlink	Uplink
Frequency		869 to 894 MHz	824 to 849 MHz
Output Power		+46dBm \pm 1dB	-8dBm \pm 1dB
ACPR	$ \Delta f \geq 750\text{kHz}$	$\geq 45\text{dBc} / 30\text{kHz}$	N/A
	$ \Delta f \geq 1.98\text{MHz}$	$\geq 60\text{dBc} / 30\text{kHz}$	
Spurious Emission	$90\text{kHz} < f < 150\text{kHz}$	$\leq -13\text{dBm} / 1\text{kHz}$	
	$150\text{kHz} < f < 30\text{MHz}$	$\leq -13\text{dBm} / 10\text{kHz}$	
	$30\text{MHz} < f < 1\text{GHz}$	$\leq -13\text{dBm} / 100\text{kHz}$	
	$1\text{GHz} < f < 5\text{GHz}$	$\leq -13\text{dBm} / 1\text{MHz}$	
Noise figure		N/A	$\leq 2.5\text{dB}$
ALC range		6dB	30dB
VSWR		$\leq 1.5:1$	
ANT port		7/16 female	
Optical interface (master RU only)		LC/PC	
Temperature of operation		-40 ~ +60°C	
Power supply		AC 110V / 220V \pm 20%	
Current		< 1A @ Full power, 110VAC / 220VAC input	
Weight		16Kg	
Dimensions (H x W x D)		120mm x 250mm x 500mm	
Weatherproof		IP65	
MTBF		100,000 Hours	
NMS Interface		Ethernet	

PCS Band Remote Unit Specification	Downlink	Uplink
Frequency (MHz)	1930 to 1990	1850 to 1910

PCS Band Remote Unit Specification		Downlink	Uplink
Output Power		+46dBm±1dB	-8dBm±1dB
ACPR	$ \Delta f \geq 885\text{kHz}$	$\geq 45\text{dBc} / 30\text{kHz}$	N/A
	$ \Delta f \geq 1.25 \text{ to } 2.25\text{MHz}$	$\leq -9\text{dBm} / 30\text{kHz}$	
	$ \Delta f \geq 2.25 \text{ to } 4\text{MHz}$	$\leq -13\text{dBm} / 1\text{MHz}$	
Spurious Emission	$9\text{kHz} < f < 150\text{kHz}$	$\leq -13\text{dBm} / 1\text{kHz}$	
	$150\text{kHz} < f < 30\text{MHz}$	$\leq -13\text{dBm} / 10\text{kHz}$	
	$30\text{MHz} < f < 1\text{GHz}$	$\leq -13\text{dBm} / 100\text{kHz}$	
	$1\text{GHz} < \Delta f < 5\text{GHz}$	$\leq -13\text{dBm} / 1\text{MHz}$	
Noise figure		N/A	$\leq 2.5\text{dB}$
ALC		6dB	30dB
VSWR		$\leq 1.5:1$	
ANT port		7/16 female	
Optical interface (master RU only)		LC/PC	
Temperature of operation		-40 ~ +60 °C	
Power supply		AC 110V / 220V ± 20%	
Current		<1A @ Full power	
Weight		16Kg	
Dimensions (H x W x D)		120mm x 250mm x 500mm	
Weatherproof		IP65	
MTBF		100,000 Hours	
NMS Interface		Ethernet	

AWS Band Remote Unit Specification		Downlink	Uplink
Frequency (MHz)		2110 to 2155	1710 to 1755
Output Power		+46dBm±1dB	-8dBm±1dB
ACLR	$ \Delta f \geq 5\text{MHz}$	$\geq 45\text{dBc} / 30\text{kHz}$	N/A
	$ \Delta f \geq 10\text{MHz}$	$\geq 50\text{dBc} / 30\text{kHz}$	
Spurious Emission	$9\text{kHz} < f < 150\text{kHz}$	$\leq -13\text{dBm} / 1\text{kHz}$	
	$150\text{kHz} < f < 30\text{MHz}$	$\leq -13\text{dBm} / 10\text{kHz}$	
	$30\text{MHz} < f < 1\text{GHz}$	$\leq -13\text{dBm} / 100\text{kHz}$	
	$1\text{GHz} < f < 5\text{GHz}$	$\leq -13\text{dBm} / 1\text{MHz}$	
	$5\text{GHz} < f < 12.75\text{GHz}$	$\leq -30\text{dBm} / 1\text{MHz}$	
Noise figure		N/A	$\leq 2.5\text{dB}$
ALC range		6dB	30dB
VSWR		$\leq 1.5:1$	
ANT port		7/16 female	
Optical interface (master RU only)		LC/PC	
Temperature of operation		-40 ~ +60 °C	
Power supply		AC 110V / 220V ±20%	
Current		< 1A @ Full power, 110V AC / 220VAC input	
Weight		16Kg	
Dimensions (H x W x D)		120mm x 250mm x 500mm	
Weather proof		IP65	
MTBF		100,000 Hours	
NMS Interface		Ethernet	

3 NETWORK MANAGEMENT SYSTEM

The Network Management System (NMS) is a software-based network management tool that provides control and monitoring function for Bravo Tech Inc. mBSC system. NMS is used to provision and configure new system for operation, set the system operating parameters, get system alarms and status messages and upgrade the system software.

3.1 Software Installation

NMS software CD-ROM will be provided to the customer with product package. Software installation consists of inserting CD-ROM in the server system of the customer.

3.2 System Start-Up Procedure with NMS

1. Open the NMS software. The NMS Log-In window will open as shown in Figure 3-1 and Figure 3-2. For setting or changing system operating parameters, the advanced login is required. (Check the box left side of "Advance" for advanced user.)



Caution: To configure the system and set the system parameters, it should be required to log in as Advanced User.



Figure 3-1. User Login Window

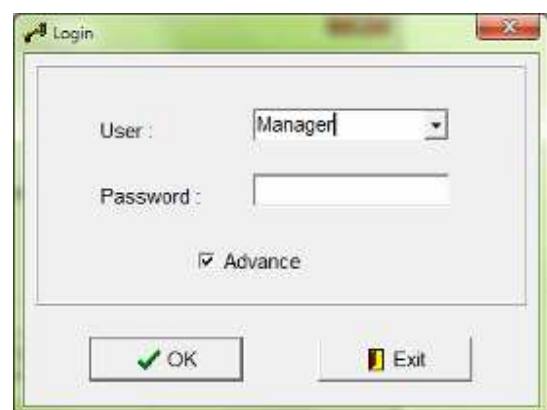

Figure 3-2. Advanced User Login Window

2. Enter the user name and password for login, the main window will open as shown in Figure 3-3.

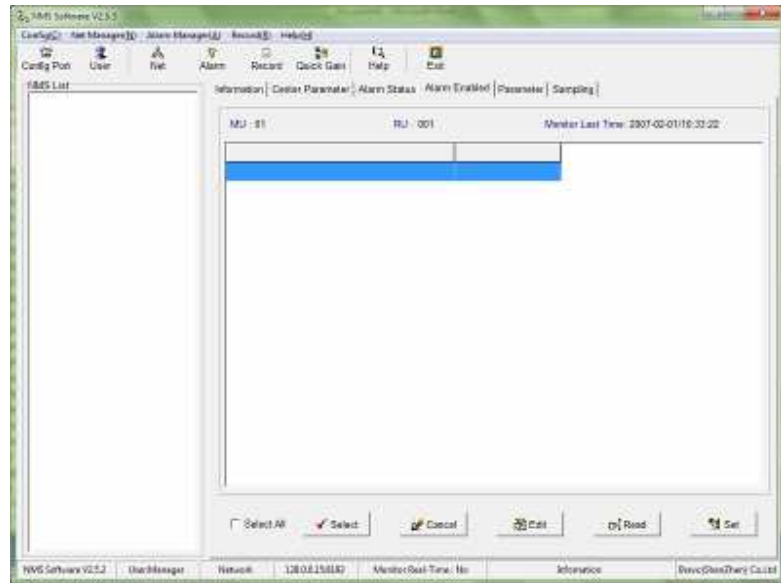

Figure 3-3. Network Management System Main Window

3. Open the Config drop down menu and select Config Port. Or click the Config Port icon menu. Configure the server IP address and port. This IP address should be same with the server IP address and port. The New window will open for setting IP address as shown in Figure 3-4.

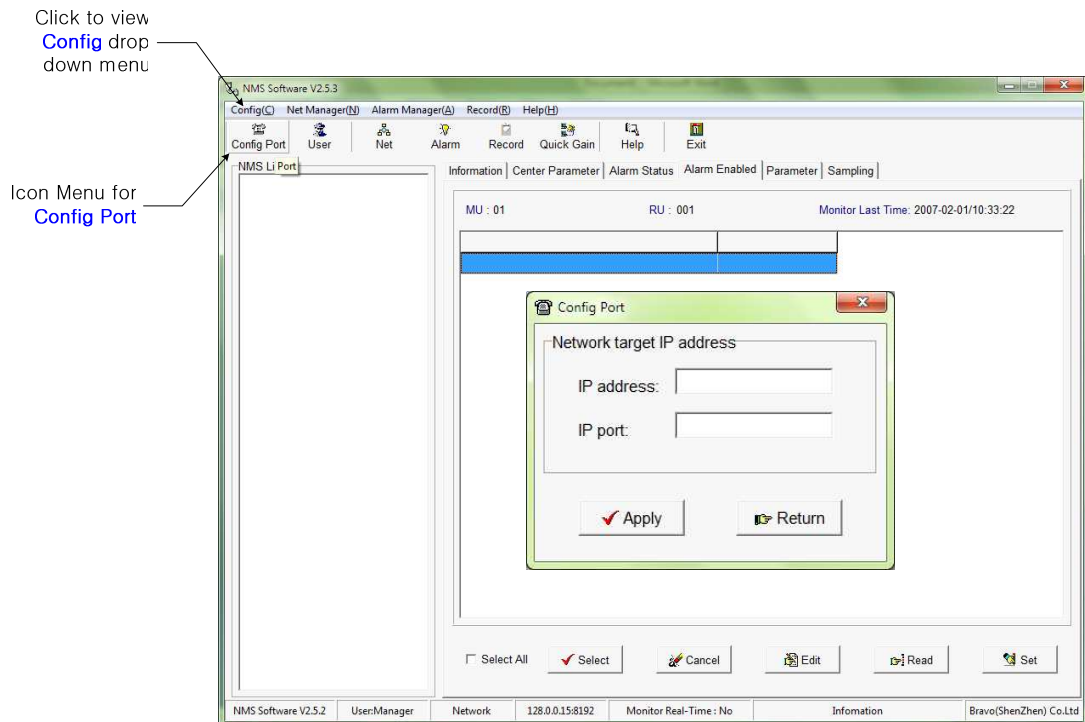

Figure 3-4. Configuration of IP Address

4. After configuring the IP address, the system configuration is required for Host Units and Remote Units. Open the Net Manager drop down menu and select “Net Manager”. Or click the Net icon

menu. The new window for the system configuration will open as shown in Figure 3-5.

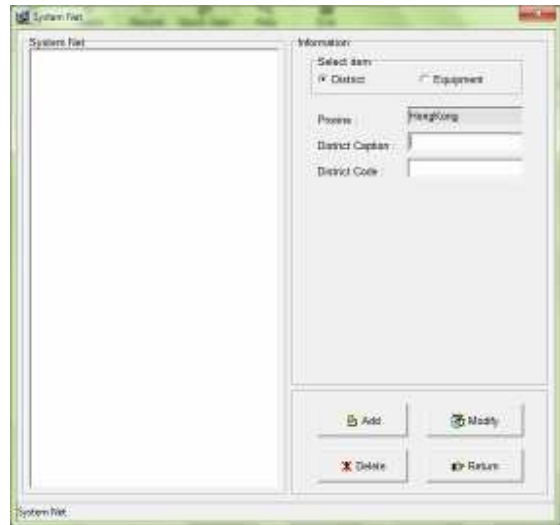

Figure 3-5. System Configuration Window

5. Define the District for highest level of system configuration as shown in Figure 3-6. User can define each section without rules. After typing the information, click the **Add** button right-bottom of the window. Figure 3-7 shows the result after defining the district

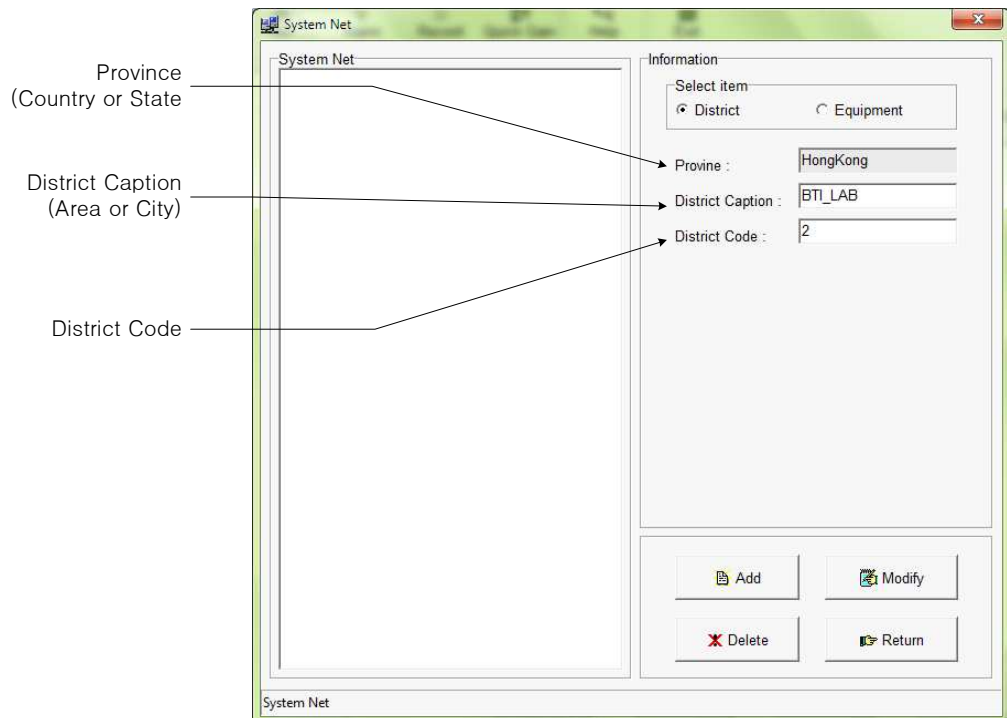

Figure 3-6. Define the District

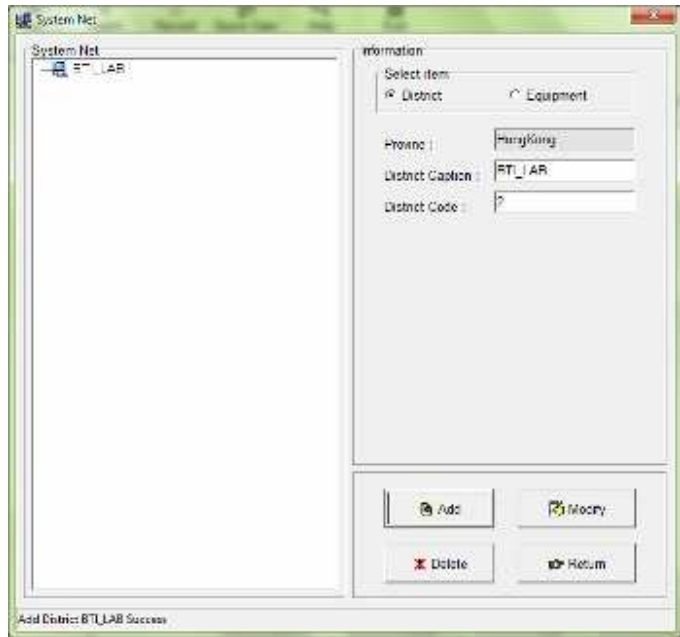

Figure 3-7. Reult window after Defining District

6. After configuring the District, the equipment should be defined. Check the **Equipment** title and new information sections will be appeared as shown in Figure 3-8. Host Unit should be defined first before adding Remote unit. Check the **MU** title and type the information for Host Unit. After filling the information, click the **Add** button. Figure 3-9 shows the result for adding Host Unit in the system configuration.

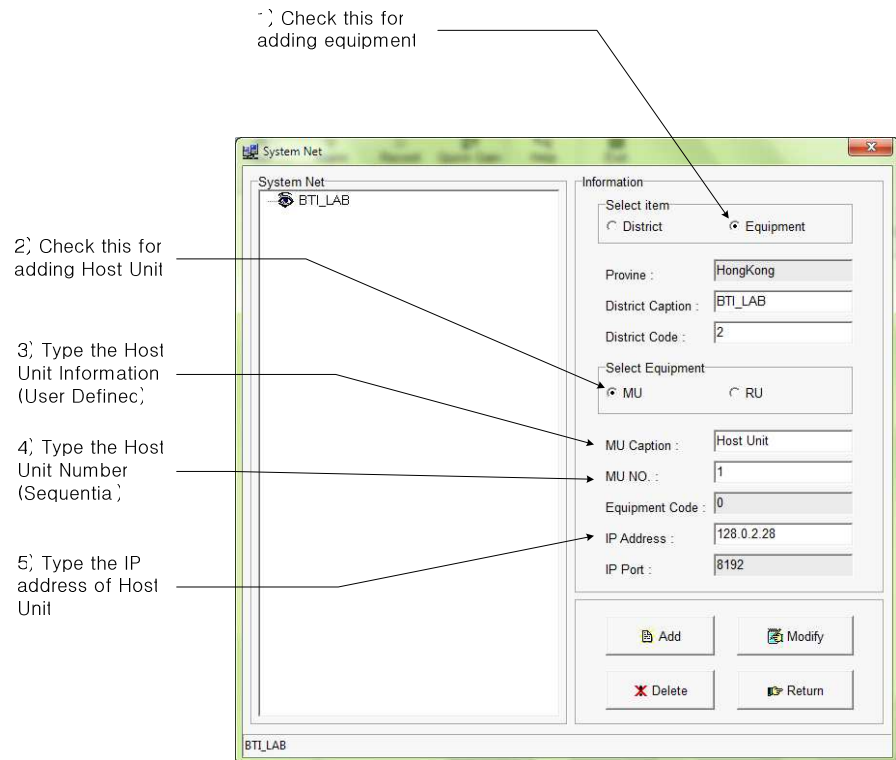

Figure 3-8. Add the Host Unit in the System configuration

⚠ Caution: When the system was shipped out, the IP address was pre-defined with default. The customer should changed HU IP address with user defined one.

- Note: the IP address of Host Unit is pre-defined when the product is shipped to the customer. The customer can change the default IP address of HU to user defined IP address.

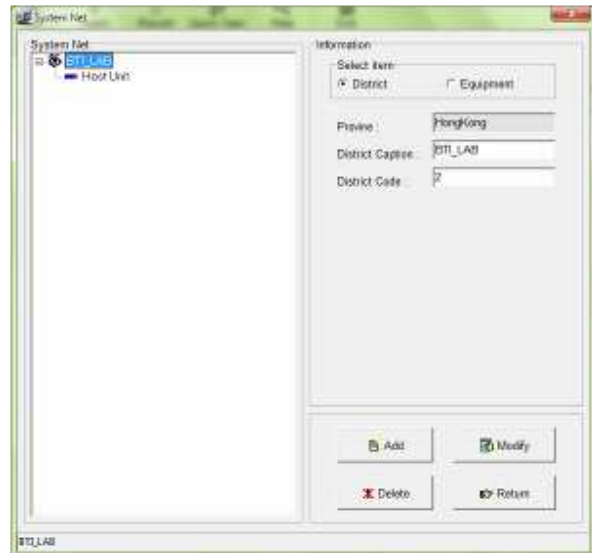

Figure 3-9. Result Window after adding HU

7. After adding Host Unit, Remote units are required to add in the system configuration with same way for adding HU, as shown in Figure 3-10.

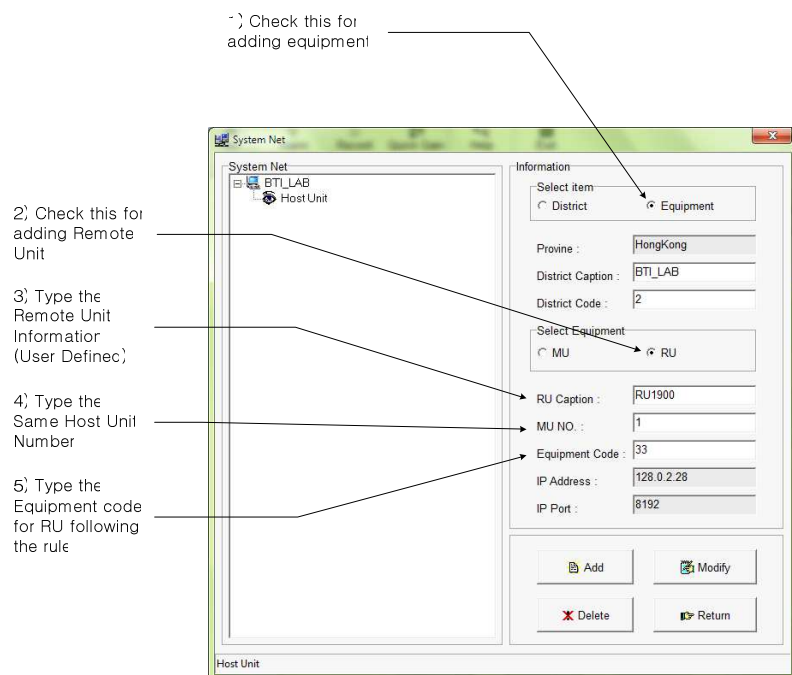

Figure 3-10. Add the Remote Unit below the Host Unit Tree

There is the rule to define the Equipment Code for Remote Unit.

Warning: *Equipment Code for RU should be followed the numbering rule for normal operation. The conflicted Cdoe may casue for the failure of configuration of the system.*

- The code will be defined with the combination of Slot ID and Port number for **FIU** module in Host Unit as shown in Table 3-1. Maximum 6 FIU modules can be installed in one HU. And the slot number is started with “1” from the left side module to right side module.

Table 3-1. Rule for numbering the Equipment Code

	Bit 7	Bit 6	Bit 5	Bit 4	Bit 3	Bit 2	Bit 1	Bit 0
FC/APC1	0							
FC/APC2	1							
Slot #1		0	0	1				
Slot #2		0	1	0				
Slot #3		0	1	1				
Slot #4		1	0	0				
Slot #5		1	0	1				
Slot #6		1	1	0				
RU Information					0	0	0	0
Note								
1. Slot # is numbered sequentially starting “1” from left side slot in HU								

8. Figure 3-11 shows the completion of the system configuration and adding Host unit and Remote Units in NMS.

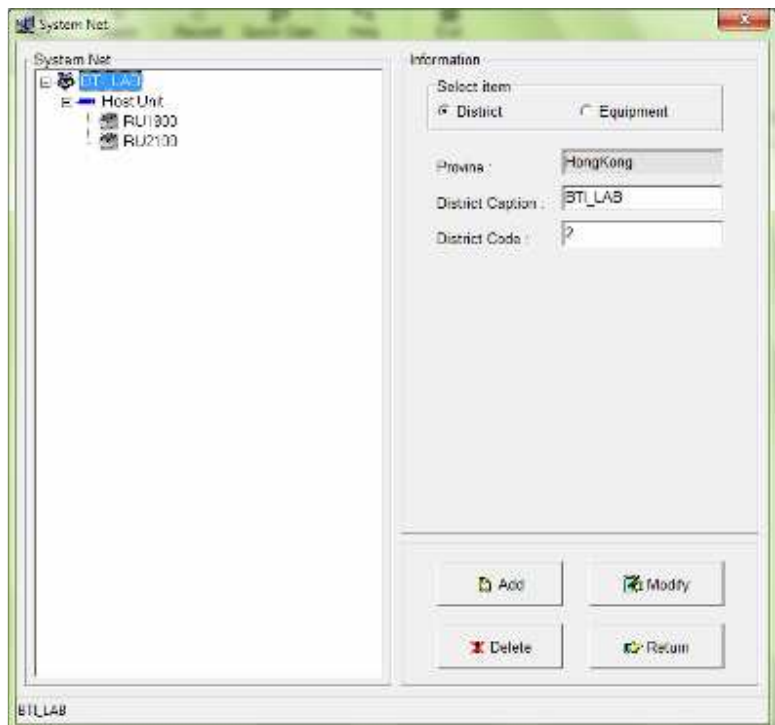

Figure 3-11. Completion of the System Configuration

3.3 Read and Edit the current system setting parameters

The User can check the current setting values for the system parameter and edit or modify the parameters for Host Units and Remote Units. The Figure 3-12 and 3-13 shows how to read the current setting parameters and edit the parameters for Host Unit. Remote unit has the same procedure to read and modify the parameters

1) Select Host Unit or Remote Unit

2) Select any tap menu to be reac

3) Click Parameter List button to show the items

4) Check Select All for all items or click the Select button for one items

5) Click the Reac button to read the current setting value for HL

6) Column for current setting information of HL

Selected	Item	Current Value	Edit Value	Edit Rule
<input type="checkbox"/>	Manufacturer Code	1		Number, 0 <= X <= 255
<input type="checkbox"/>	Device Type	25		Number, 0 <= X <= 255
<input type="checkbox"/>	Device Mode	MBSC-1921		Character ShortString, Maxima
<input type="checkbox"/>	Device S/N	MU_2008051500001		Character ShortString, Maxima
<input type="checkbox"/>	Channel Number	4		Number, 0 <= X <= 255
<input type="checkbox"/>	Longitude	E103.12345678		Character ShortString, Maxima
<input type="checkbox"/>	Latitude	N103.12345678		Character ShortString, Maxima
<input type="checkbox"/>	Software Version	SOFT_1.00a_20091014		Character ShortString, Maxima

Figure 3-12. Read the current setting for the system

1) Select Host Unit or Remote Unit

2) Select any tap menu to be modified

3) Check the Column for current setting information

4) Click the Select button for the item to be modified

5) Click the Edit button to modify the value

6) Type the new value for HU or RL

7) Click the Set button to apply the new value to the system

Selected	Item	Current Value	Edit Value	Edit Rule
<input type="checkbox"/>	Site No.	00220001		Number, 0 <= X <= 429496
<input type="checkbox"/>	Device No.	0		Number, 0 <= X <= 255
<input type="checkbox"/>	Monitor centre IP address	128.0.0.15		128.0.2.28
<input type="checkbox"/>	Monitor centre IP port	8192		Number, 0 <= X <= 65535
<input type="checkbox"/>	Report type	3		Number, 0 <= X <= 255
<input type="checkbox"/>	Date & Time	2008-08-16 12:55:00	2009-12-14 17:02:00	Number ShortString, 2006-

Figure 3-13. Modify the parameters for the system

3.4 Read and Modify the System Gain Budget

The User can read the current setting value for the system gain budget of downlink and uplink. The parameters can be read for each HU and RU. Also the User can modify the gain budget for downlink and uplink for whole HU and RU system or for individual Host Unit and Remote Unit. The Figure 3-14 shows the current parameter setting for the system gain budget and the procedure of modifying the parameter.

1) Select Host Unit or Remote Unit

2) Select Parameter tap

3) Check the **Select All** box for all items or Click the **Select** button for one item

4) Click the **Read** button to check the parameters

5) Read the current setting parameters

Selected	Item	Current Value	Edit Value	Edit Rule
<input type="checkbox"/>	Downlink PA Enable/Disable	Enabled		Boolean logic
<input type="checkbox"/>	Uplink Attenuation	0 dB		Number, 0 <= X <= 25
<input type="checkbox"/>	Downlink Attenuation	8 dB		Number, 0 <= X <= 25
<input type="checkbox"/>	Downlink OverDrive alarm threshold	-5 dBm		Float, -3276.8 <= X <
<input type="checkbox"/>	Downlink OverPower alarm threshold	46.5 dBm		Float, -3276.8 <= X <
<input type="checkbox"/>	Downlink VSWR alarm threshold	5		Float, 0 <= X <= 25.5
<input type="checkbox"/>	Downlink OverTemperature alarm threshold	95 °C		Number, -128 <= X <

1) Select Host Unit or Remote Unit

2) Select Parameter tap

3) Click the **Select** button for one item to change the setting

4) Click the **Edit** button to modify the value

5) Key in the new value

6) Click the **Set** button to modify the value

Figure 3-14. Modify the parameters for the system

3.5 Check Alarm Status for the system

The User can check the current alarm status for Host Unit and Remote Unit with NMS. The Figure 3-15 shows how to read the current alarm status. Also the User can make enable or disable for each alarms for required purpose as shown Figure in 3-16.

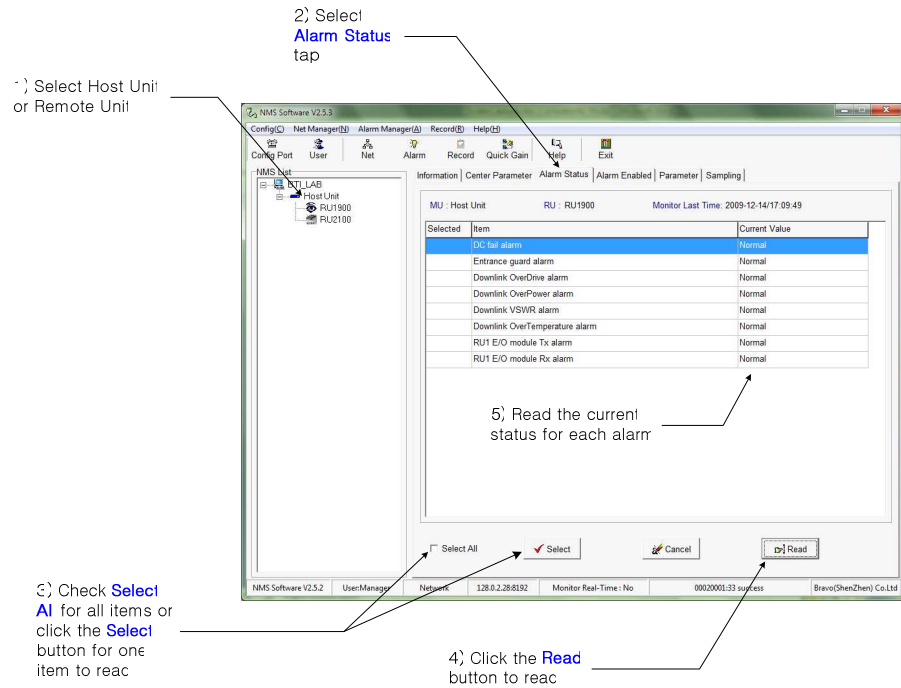

Figure 3-15. Read the current Alarm Status

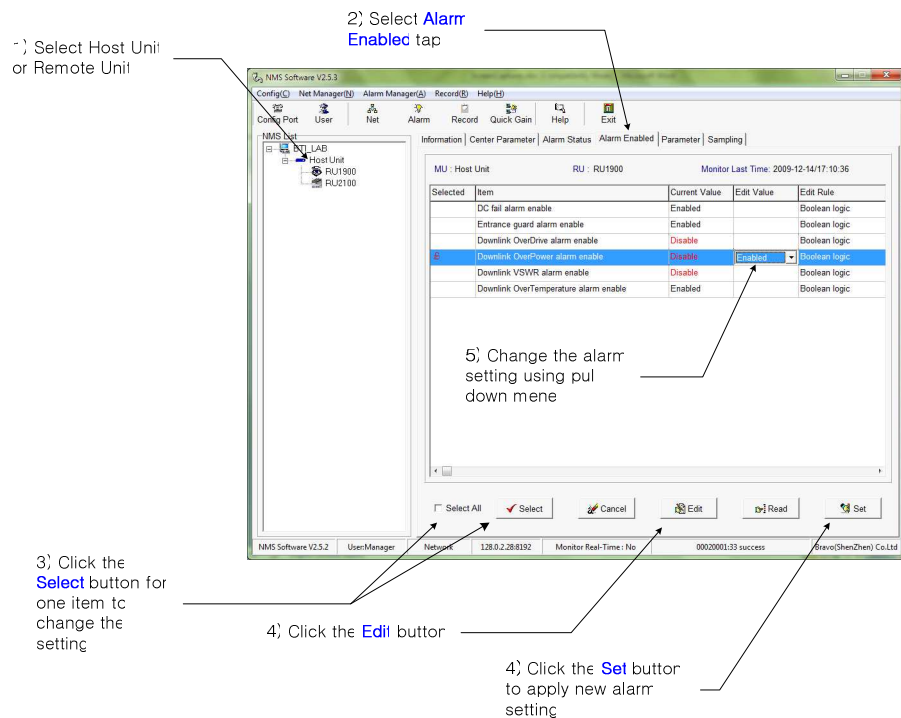

Figure 3-16. Change the Alarm Setting

3.6 Check the Major performance for the system

The User can check the current status of the HU and RU for major items that is related with main system performance like downlink output power, temperature of unit and so on. The Figure 3-17 shows the main performance of the system in one window.

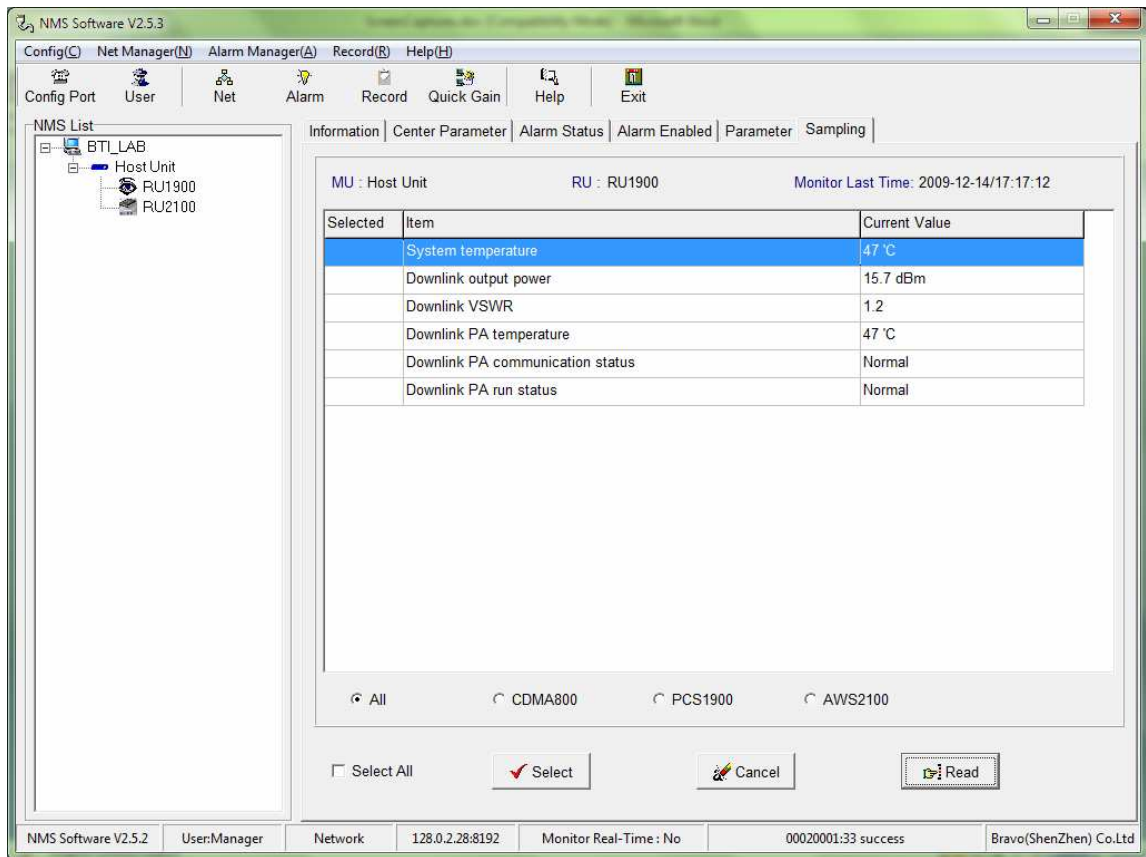

Figure 3-17. Check the system performance

4 ANTENNA MOUNT ENVIRONMENT

The effective radiated power (ERP) limits and power & antenna height limits are related with the distance between operating area and international borders, average distance to the service area boundary, population densities, emission bandwidth, base stations location, different operation frequency band. The antenna for this system is provided and assembled by customer. Customer should follow FCC certification section 22, 24 and 27 when assembled their antenna on this system.

5 FCC WARNING

Any Changes or modifications not expressly approved by the party responsible for compliance could void the user's authority to operate the equipment.

This device complies with part 15 of the FCC Rules. Operation is subject to the following two conditions:

- (1) This device may not cause harmful interference, and
- (2) This device must accept any interference received, including interference that may cause undesired operation.

IMPORTANT NOTE:

FCC Radiation Exposure Statement:

This equipment complies with FCC radiation exposure limits set forth for an controlled environment .
This equipment should be installed and operated with minimum distance 400 cm between the radiator & your body

6 CUSTOMER CONTACT INFORMATION

USA

Bravo Tech Inc.

6185 Phyllis Dr. Unit D. Cypress, CA 90630, USA

Tel: +1 714-230-8333

Fax: +1 714-230-8341

E-mail: _____

Customer Service: CustomerService@bravotechinc.com

Sales: sales@bravotechinc.com

China

Bravo Tech (Shenzhen) Co., Ltd.

No.8 Building, Zone #3, Tangtou Industrial Park,
Shiyan, Baoan District, Shenzhen, Guangdong

P.R.China 518102

Tel: +86 755-2951-2233

Fax: +86 755-2951-2299 _____

E-mail: chinasales@bravotechinc.com