



User Manual

AirStation

WZR-1166DHP

www.buffalotech.com

Contents

Chapter 1 - Product Overview	5
Package Contents.....	5
Hardware Overview.....	6
Front Panel LEDs.....	6
Back Panel.....	8
Bottom.....	9
Right Side	10
Vertical Placement	11
Horizontal Placement.....	11
Wall-Mounting	12
Chapter 2 - Installation.....	13
Initial Setup	13
Appendix A - Specifications	16
WZR-1750DHP	16
WZR-1166DHP	19
Appendix B - Environmental Information.....	22
Appendix C - GPL Information	23

Chapter 1 - Product Overview

Package Contents

The following items are included in your AirStation package. If any of the items are missing, please contact your vender.

- AirStation 1
- AirStation Setup Card 1
- AC adapter 1
- Stands..... 2
- Screws for wall-mounting 2
- Ethernet Cable 1
- Quick Setup Guide..... 1
- Warranty Statement..... 1

Hardware Overview

Front Panel LEDs

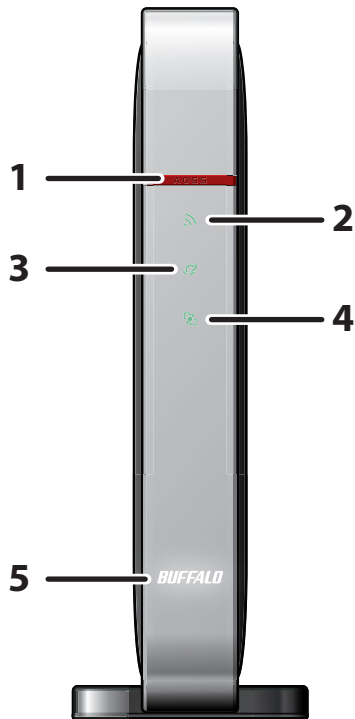

1 AOSS button To initiate AOSS, hold down this button until the wireless LED flashes (about 1 second). Then, push or click the AOSS button on your wireless client device to complete the connection. Both devices must be powered on for this to work.

2 Wireless LED (Blue or Amber)

On: Wireless LAN is enabled.

Randomly blinking: Wireless LAN is transmitting.

Double blinks: AirStation is waiting for an AOSS or WPS security key.

Continuously blinking: AOSS/WPS error; failed to exchange security keys.

Off: Wireless LAN is disabled.

Note:

Wireless LED is blue : Security settings have been made for the wireless LAN.

Wireless LED is amber : Security settings have not been made for the wireless LAN.

3 Internet access LED (Blue)

- On: Internet access is available.
- Off: Internet access is not available.
Router functionality is disabled.

4 Router LED (Blue)

- On: Router functionality is enabled.
- Off: Router functionality is disabled.

5 Buffalo LED (White or Red)

- On (White): Power is on.
 - Off: Power is off.
 - On (Red)*1: Booting.
 - 2 blinks (Red)*2: Flash ROM error.
 - 3 blinks (Red)*2: Wired Ethernet LAN error.
 - 4 blinks (Red)*2: Wireless LAN error.
 - 5 blinks (Red)*3: IP address setting error.
 - 9 blinks (Red)*2: System error.
- Continuously blinking*1: Updating firmware, saving settings, or initializing settings.

*1 Never unplug the AC adapter while the Buffalo LED is blinking continuously.

*2 Turn off AirStation first, wait for a few seconds, then turn it back on.

*3 Because the network addresses of both the Internet port (WAN port) and the LAN port are the same, it is not possible to establish communication. Change the LAN-side IP address of the AirStation.

Back Panel

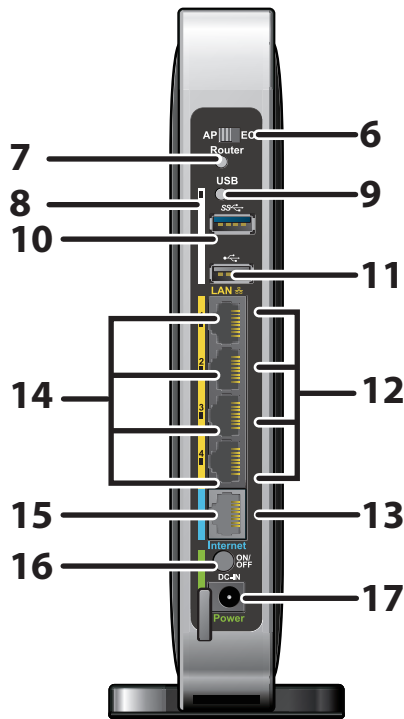

- 6 Mode switch** Switches operation mode.
- 7 Mode button** This button turns the router on and off. The operation mode is changed by holding down the button.
- 8 USB LED (Blue)**
 - On: A USB drive is connected.
 - Blinking: A USB drive can be removed.
 - Note: When this LED is blinking, the connected USB drive cannot be used. Remove the connected USB drive. If the LED continues to blink even after the USB drive is removed, restart the AirStation. Do not remove the USB drive or turn off the AirStation while the USB LED is on.
- 9 USB Eject button** To dismount a USB hard drive, hold down this button until the USB LED flashes (about 3 seconds). The USB drive can then be unplugged safely.
- 10 USB 3.0 Port** Connect the USB drive.
- 11 USB 2.0 Port** Connect the USB drive.
- 12 LAN Port** Connect your computer, hub, or other Ethernet devices to these ports. This switching hub supports 10 Mbps, 100 Mbps, and 1000 Mbps connections.

13 Internet Port 10 Mbps, 100 Mbps, and 1000 Mbps connections are supported.
Note: In bridge/AP mode (router off), the Internet port becomes a regular LAN port, for a total of 5 usable LAN ports.

14 LAN LED (Green)

On: An Ethernet device is connected.
Blinking: An Ethernet device is communicating.

15 Internet LED (Green)

On: The Internet port is connected.
Blinking: The Internet port is transmitting data.

16 Power button This button turns the power on and off.

17 DC connector Connect the included AC adapter here.

Bottom

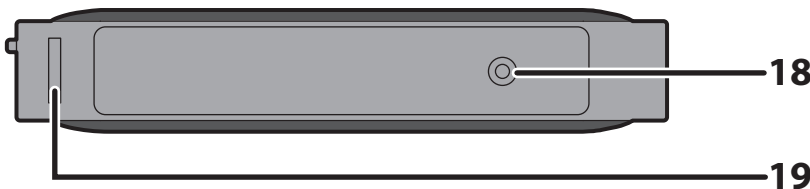

18 Reset button To reset all settings, hold down this button until the Buffalo LED turns red (about 3 seconds). The power must be on for this to work.

19 Setup card slot This is the slot where the AirStation setup card is stored. The initial settings for the username, password, SSID, and encryption type are provided on the card for logging into the configuration interface.

Right Side

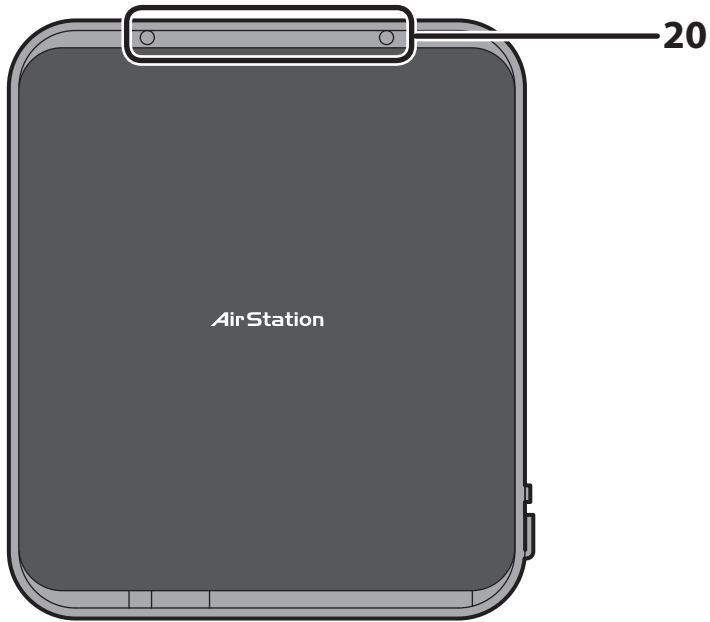

20 Mounting holes

Mounting holes are provided for mounting the AirStation to a wall. Use the supplied screws to mount to a wall.

Vertical Placement

Attach the stand as shown in the figure below.

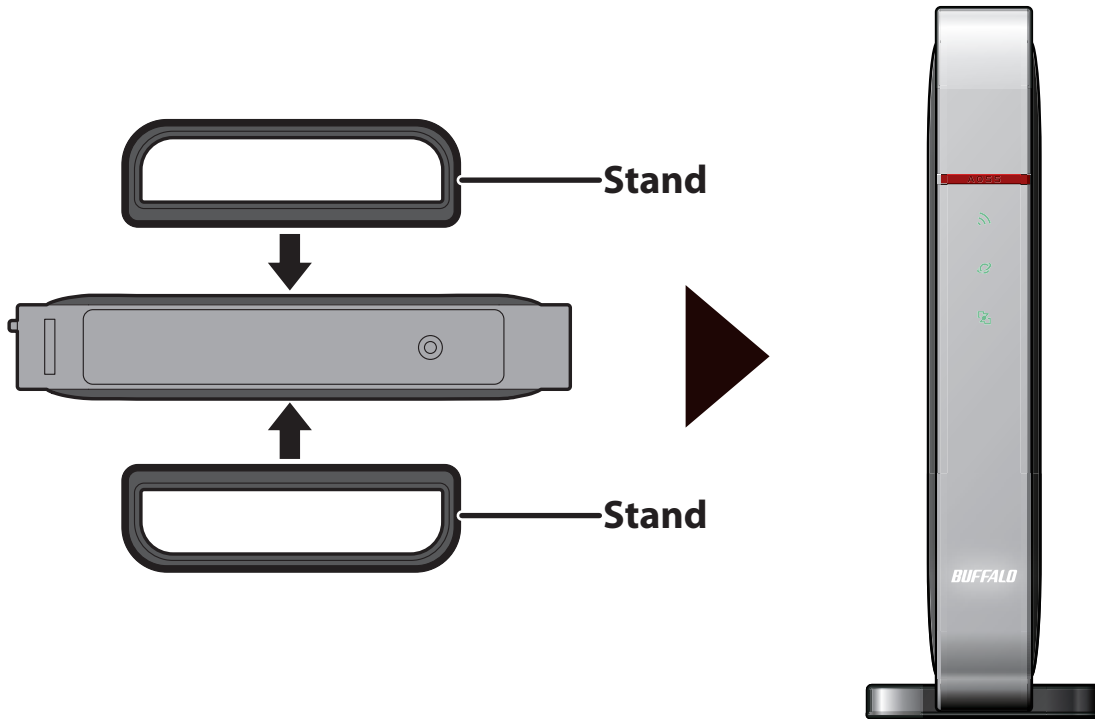

Horizontal Placement

The same stand also allows horizontal placement. Install the stand as shown in the figure below.

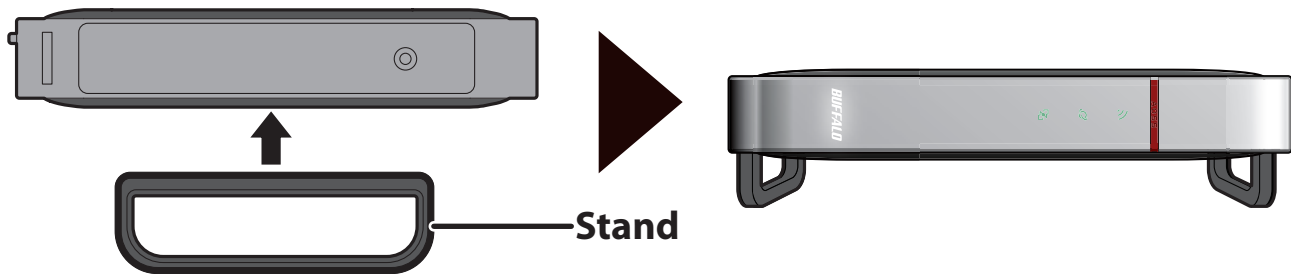

Wall-Mounting

Attach to the wall with the supplied screws in the mounting holes as shown below.

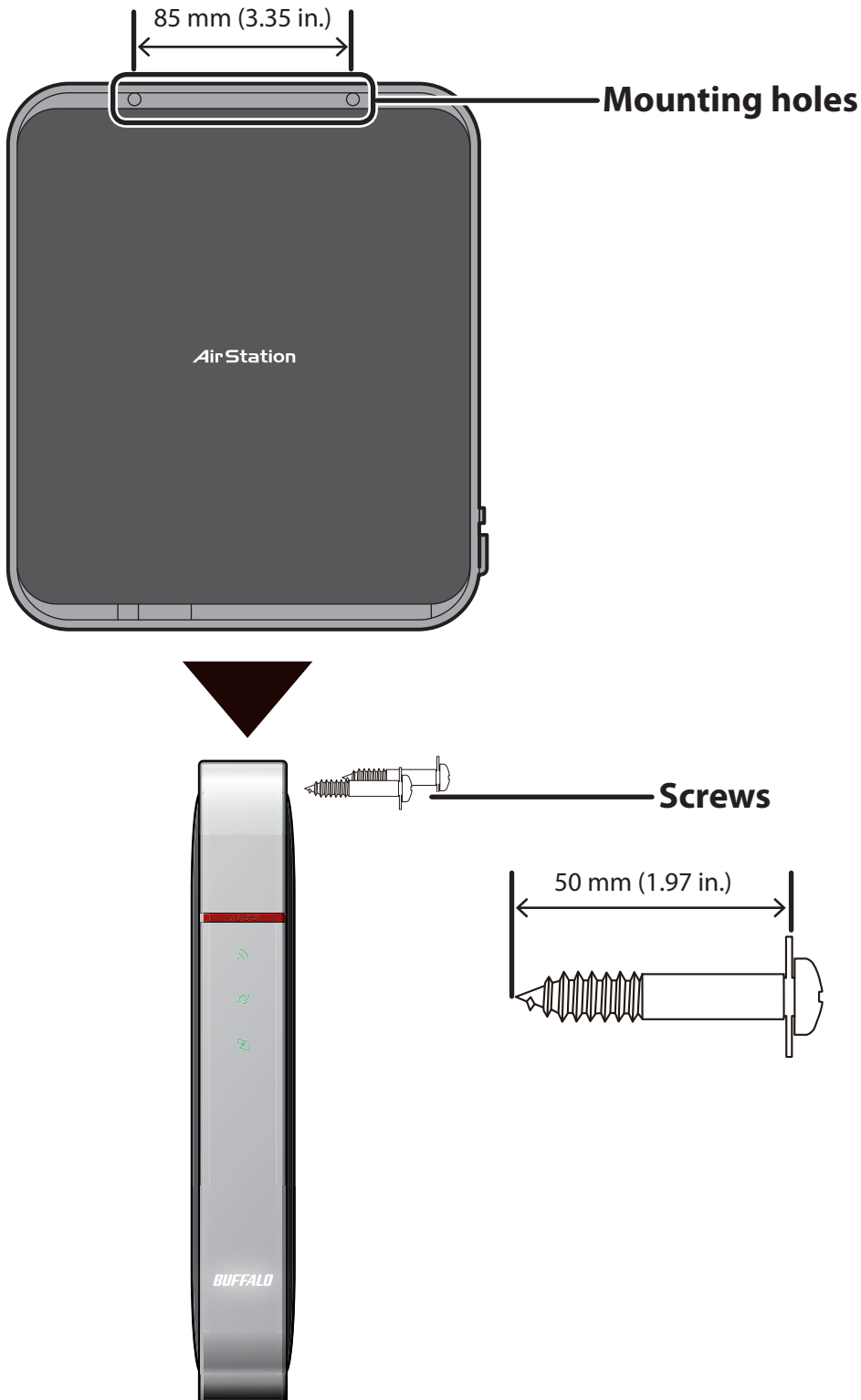

Chapter 2 - Installation

Initial Setup

To configure your AirStation, follow the procedure below.

- 1** Verify that you can connect to the internet without the AirStation, then turn off your modem and computer.

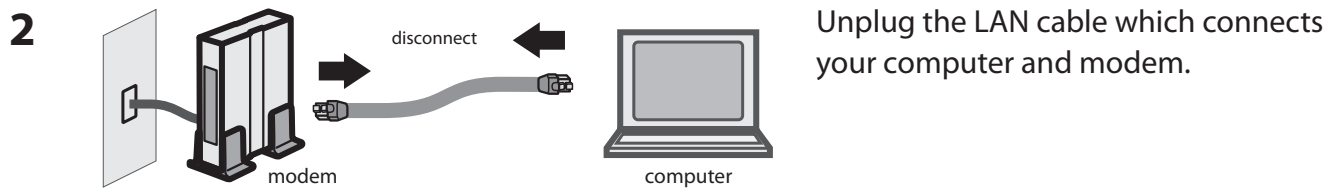

- 3** Plug one end of the LAN cable into your modem and the other end to the AirStation's Internet (WAN) port. Turn on the modem.

4 Turn on the AirStation, then wait one minute.

Note : If the power does not turn on even when the AC adapter is connected, press the Power button on the rear of the AirStation.

5 If using a wired LAN, connect the AirStation LAN port and computer using a LAN cable. If using a wireless LAN, connect the computer to the wireless LAN.

6 Once your computer has booted, the AirStation's LEDs should be lit as described below:

Power	On.
Wireless	On or blinking.
Internet access	On.
Router	On.
LAN	On or blinking.
Internet	On or blinking.

For LED locations, refer to chapter 1.

Note: If the router LED is not lit, hold down the router button to switch to router mode.

- 7** Launch a web browser. If the home screen is displayed, setup is complete. If username and password fields are displayed, enter “admin” for the username and “password” for the password, then click [OK]. Step through the wizard to complete setup.

You’ve completed the initial setup of your AirStation.



WZR-1166DHP

Wired LAN Interface	
Standard Compliance	IEEE802.3ab (1000BASE-T), IEEE802.3u (100BASE-TX), IEEE802.3 (10BASE-T)
Transmission Rate	10 / 100 / 1000 Mbps
Transmission Encoding	1000BASE-T 4DPAM5, 100BASE-TX 4B5B/MLT-3, 10BASE-T Manchester Coding
Access Method	CSMA/CD
Speed and Flow Control	10 / 100 / 1000 Mbps, Auto Sensing, Auto MDIX
Number of LAN Ports	4
LAN Port Connector	RJ-45
Wireless LAN Interface	
Standard Compliance	IEEE802.11ac (Draft 2.0) /n/a/g/b
Transmission Method	Direct Sequence Spread Spectrum (DSSS), OFDM, MIMO
Frequency Range	Available frequencies depend on the country of purchase. See the next page for details.
Transmission Rate 802.11ac (Draft)	802.11ac (Draft): 20 MHz BW (Long GI) 156, 130, 117, 104, 78, 52, 39, 26, 13 Mbps (2 stream) 78, 65, 58.5, 52, 39, 26, 19.5, 13, 6.5 Mbps (1 stream) 20 MHz BW (Short GI) 173.3, 144.4, 130, 115.6, 86.7, 57.8, 43.3, 28.9, 14.4 Mbps (2 stream) 86.7, 72.2, 65, 57.8, 43.3, 28.9, 21.7, 14.4, 7.2 Mbps (1 stream) 40 MHz BW (Long GI) 360, 324, 270, 243, 216, 162, 108, 81, 54, 27 Mbps (2 stream) 180, 162, 135, 121.5, 108, 81, 54, 40.5, 27, 13.5 Mbps (1 stream) 40 MHz BW (Short GI) 400, 360, 300, 270, 240, 180, 120, 90, 60, 30 Mbps (2 stream) 200, 180, 150, 135, 120, 90, 60, 45, 30, 15 Mbps (1 stream) 80 MHz BW (Long GI) 780, 702, 585, 526.5, 468, 351, 234, 175.5, 117, 58.5 Mbps (2 stream) 390, 351, 292.5, 263.3, 234, 175.5, 117, 87.8, 58.5, 29.3 Mbps (1 stream) 80 MHz BW (Short GI) 866.7, 780, 650, 585, 520, 390, 260, 195, 130, 65 Mbps (2 stream) 433.3, 390, 325, 292.5, 260, 195, 130, 97.5, 65, 32.5 Mbps (1 stream)

Transmission Rate 802.11n/a/b/g	<p>802.11n:</p> <p>20 MHz BW (Long GI) 130, 117, 104, 78, 52, 39, 26, 13 Mbps (2 stream) 65, 58.5, 52, 39, 26, 19.5, 13, 6.5 Mbps (1 stream)</p> <p>20 MHz BW (Short GI) 144.4, 130, 115.6, 86.7, 57.8, 43.3, 28.9, 14.4 Mbps (2 stream) 72.2, 65, 57.8, 43.3, 28.9, 21.7, 14.4, 7.2 Mbps (1 stream)</p> <p>40 MHz BW (Long GI) 270, 243, 216, 162, 108, 81, 54, 27 Mbps (2 stream) 135, 121.5, 108, 81, 54, 40.5, 27, 13.5 Mbps (1 stream)</p> <p>40 MHz BW (Short GI) 300, 270, 240, 180, 120, 90, 60, 30 Mbps (2 stream) 150, 135, 120, 90, 60, 45, 30, 15 Mbps (1 stream)</p> <p>802.11a/g: 54, 48, 36, 24, 18, 12, 9, 6 Mbps</p> <p>802.11b: 11, 5.5, 2, 1 Mbps</p>
Access Mode	Infrastructure Mode
Security	AOSS, WPA2-PSK (AES), WPA/WPA2 mixed PSK, WPA-PSK (AES), 64-bit or 128-bit WEP, Mac Address Filter
USB Interface	
Interface	USB 2.0 port x 2
Connector Type	Type A (plug)
Compliance	5.0 V 500 mA (max 1000 mA)
Other	
Power Supply	External AC 100-240 V Universal, 50/60 Hz
Power Consumption	TBD
Dimensions	212 x 183 x 34 mm (8.4 x 7.2 x 1.3 in.)
Weight	TBD
Operating Environment	0 - 40° C (32 - 104° F), 10 - 85% (non-condensing)

Frequency Range	
USA Canada Mexico	5180-5240 MHz (Channels 36, 40, 44, 48) 5745-5825 MHz (Channels 149, 153, 157, 161, 165) 2412-2462 MHz (Channels 1, 2, 3, 4, 5, 6, 7, 8, 9, 10, 11)
EU Middle East	5180-5240 MHz (Channels 36, 40, 44, 48) 5260-5320 MHz (Channels 52, 56, 60, 64) 2412-2472 MHz (Channels 1, 2, 3, 4, 5, 6, 7, 8, 9, 10, 11, 12, 13)
India Australia Hong Kong Singapore Malaysia	5180-5240 MHz (Channels 36, 40, 44, 48) 5260-5320 MHz (Channels 52, 56, 60, 64) 5745-5825 MHz (Channels 149, 153, 157, 161, 165) 2412-2472 MHz (Channels 1, 2, 3, 4, 5, 6, 7, 8, 9, 10, 11, 12, 13)
Philippines Thailand	5180-5240 MHz (Channels 36, 40, 44, 48) 5260-5320 MHz (Channels 52, 56, 60, 64) 5745-5825 MHz (Channels 149, 153, 157, 161, 165) 2412-2472 MHz (Channels 1, 2, 3, 4, 5, 6, 7, 8, 9, 10, 11, 12, 13)
Taiwan	5745-5825 MHz (Channels 149, 153, 157, 161, 165) 2412-2462 MHz (Channels 1, 2, 3, 4, 5, 6, 7, 8, 9, 10, 11)
South Korea	5260-5320 MHz (Channels 52, 56, 60, 64) 5745-5825 MHz (Channels 149, 153, 157, 161, 165) 2412-2472 MHz (Channels 1, 2, 3, 4, 5, 6, 7, 8, 9, 10, 11, 12, 13)

Appendix B - Environmental Information

- The equipment that you have purchased has required the extraction and use of natural resources for its production.
- The equipment may contain hazardous substances that could impact health and the environment.
- In order to avoid the dissemination of those substances in our environment and to diminish the pressure on the natural resources, we encourage you to use the appropriate take-back systems.
- The take-back systems will reuse or recycle most of the materials of your end life equipment in a sound way.
- The crossed-out wheeled bin symbol invites you to use those systems.



- If you need more information on collection, reuse, and recycling systems, please contact your local or regional waste administration.

Appendix C - GPL Information

The source code for Buffalo products that use GPL code is available at <http://opensource.buffalo.jp/>.