

User Manual

Wireless AC1300 / N450 Gigabit Dual Band Media Bridge

WLI-H4-D1300



www.buffalotech.com

Contents

Chapter 1 - Product Overview	4
Package Contents.....	4
Hardware Overview.....	5
Front Panel LEDs.....	5
Back Panel.....	7
Bottom.....	8
Right Side	8
Vertical Placement	9
Horizontal Placement.....	9
Wall-Mounting	10
Chapter 2 - Installation.....	11
Initial Setup (one-touch connection).....	11
Manual Setup.....	13
Chapter 3 - Configuration	14
Installing the Ethernet Converter Manager (Windows)	14
Setting the AirStation IP Address (Windows)	15
Accessing the Web-based Configuration Interface (Windows).....	17
Accessing the Web-based Configuration Interface (Mac OS X).....	19
Configuration Interface Menus	20
Setup.....	21
LAN Config.....	22
LAN.....	22
Wireless Config.....	23
WPS.....	23
AOSS	24
Basic	25

Advanced	27
WMM.....	28
Admin Config.....	30
Name	30
Password	31
Time/Date	32
NTP	33
Access	34
Log.....	35
Save/Restore	36
Initialize/Restart	37
Update	38
Diagnostic	39
System Info	39
Logs	40
Packet Info	41
Client Monitor	42
Ping.....	43

Chapter 4 - TroubleShooting 44

When connection to a wireless router is not possible	44
You forgot the SSID, encryption key, or password for the wireless network.....	44
Restoring the Default Configuration.....	44
TCP/IP Settings (Windows 7).....	45
TCP/IP Settings (Windows Vista).....	46
TCP/IP Settings (Windows XP).....	47
TCP/IP Settings (Mac OS X).....	48
Other Tips.....	49

Appendix 50

Specifications 50

Default Configuration Settings 53

Ethernet Converter Manager..... 56

 Ethernet Converter Manager Overview 56

 Opening and Closing Ethernet Converter Manager..... 56

 Select LAN Adapter screen..... 57

 Select Ethernet Converter..... 58

 Main Screen..... 59

 Modify IP Address Screen..... 61

 Connection Settings..... 62

Regulatory Compliance Information..... 63

Environmental Information 69

GPL Information 69

Chapter 1 - Product Overview

Package Contents

The following items are included in your AirStation package. If any of the items are missing, please contact your vender.

- WLI-H4-D1300 1
- AC adapter 1
- Stands..... 2
- Screws for wall-mounting 2
- LAN cable 1
- AirNavigator CD..... 1
- Quick Setup Guide..... 1
- Warranty Statement..... 1

Hardware Overview

Front Panel LEDs

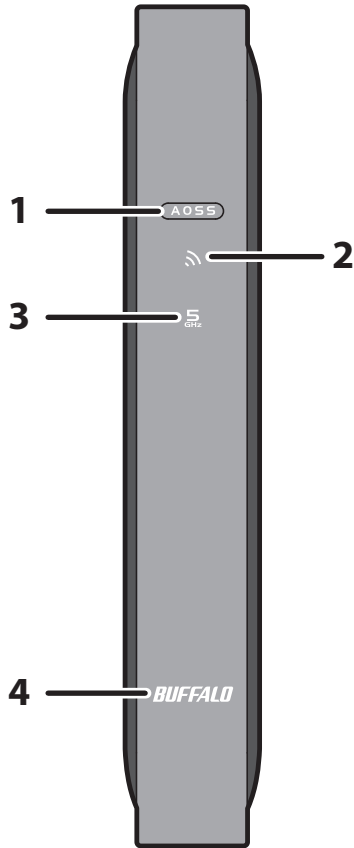

1 AOSS / WPS button To initiate AOSS/WPS, hold down this button until the Wireless LED flashes (about 1 second). Then, push the AOSS or WPS button on your wireless access point to complete the connection. Both devices must be powered on for this to work.

2 Wireless LED (Blue or Amber)

- On: Wireless LAN is enabled.
- Blinking: Wireless LAN is transmitting.
- 2 blinks: AirStation is waiting for an AOSS or WPS security key.
- Continuously blinking: AOSS/WPS error; failed to exchange security keys.
- Off: Wireless LAN is disabled.

Note:

- Wireless LED is blue : Security settings have been made for the wireless LAN.
- Wireless LED is amber : Security settings have not been made for the wireless LAN.

3 5 GHz Fixed mode LED (Blue)

On: Operating in 5 GHz band fixed mode.
Off: 5 GHz band fixed mode is off.

4 Buffalo LED (White or Red)

On (White): Power is on.
Off: Power is off.
On (Red)*1: Booting.
2 blinks (Red)*2: Flash ROM error.
3 blinks (Red)*2: Wired Ethernet LAN error.
4 blinks (Red)*2: Wireless LAN error.
9 blinks (Red)*2: System error.
Continuously updating firmware, saving settings, or initializing settings.
blinking*1:

*1 Never unplug the AC adapter while the Buffalo LED is blinking continuously.

*2 Turn off AirStation first, wait for a few seconds, then turn it back on.

Back Panel

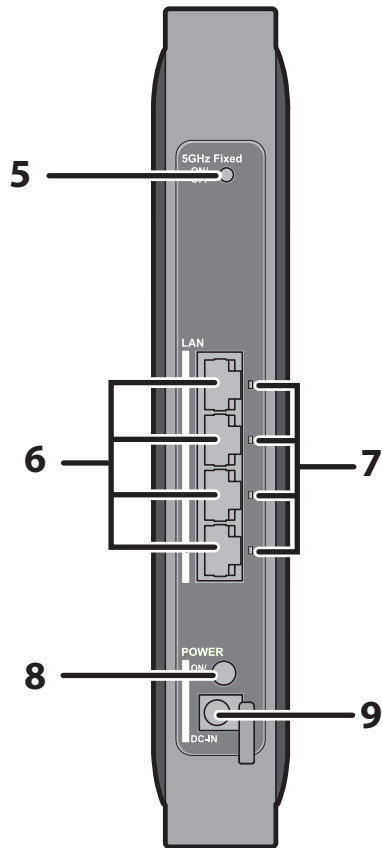

- 5 5 GHz Fixed Mode button** This button is used to enable or disable 5 GHz fixed mode. The operation mode is switched by pressing the button until the 5 GHz fixed mode LED turns on or off (about 1 second).
- 6 LAN Port** Connect your computer, hub, or other Ethernet devices to these ports. This switching hub supports 10 Mbps, 100 Mbps, and 1000 Mbps connections.
- 7 LAN LED (Green)**
 - On: An Ethernet device is connected.
 - Blinking: An Ethernet device is communicating.
- 8 Power button** This button turns the power on and off.
- 9 DC Connector** Connect the included AC adapter here.

Bottom



10 Reset button

To reset all settings, hold down this button until the Buffalo LED turns red (about 3 seconds). The power must be on for this to work.

Right Side

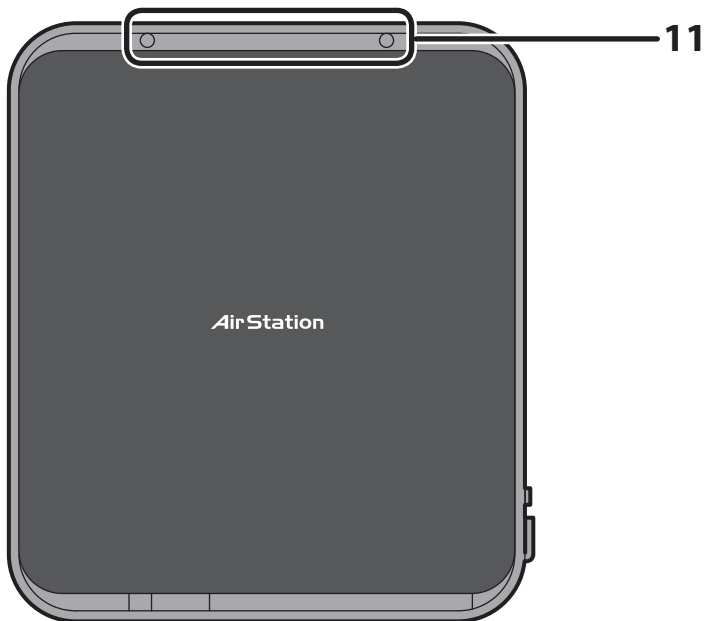

11 Mounting holes

Mounting holes are provided for mounting the AirStation to a wall. Use the supplied screws in the holes to mount to a wall.

Vertical Placement

Attach the stand as shown in the figure below.

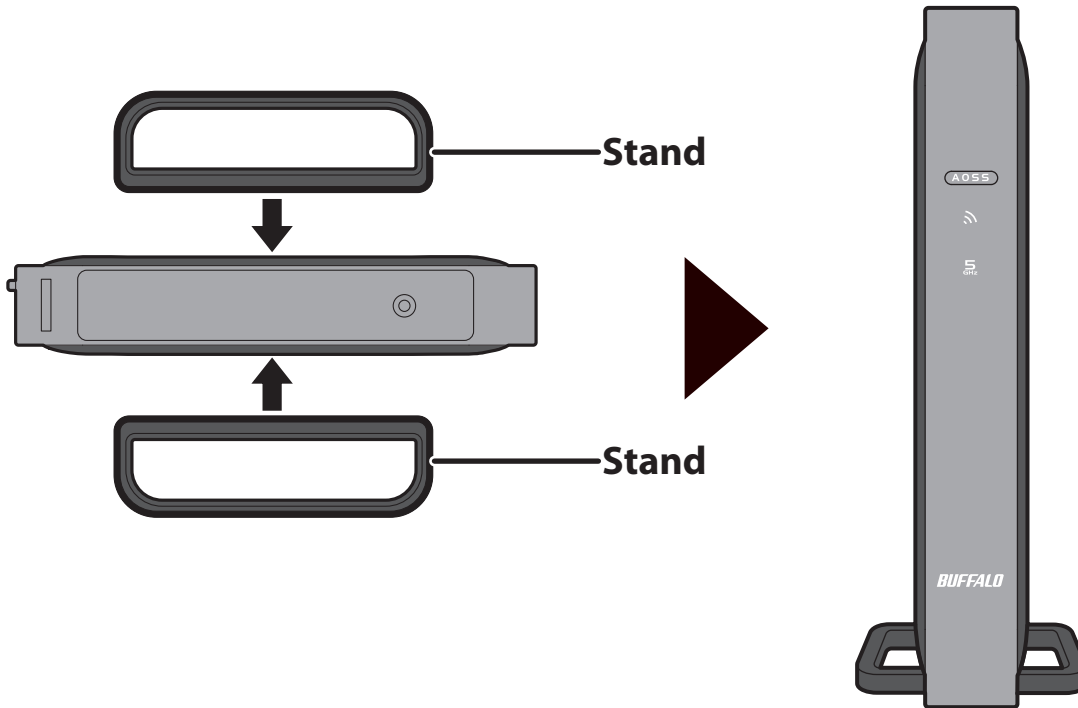

Horizontal Placement

The same stand also allows horizontal placement. Install the stand as shown in the figure below.

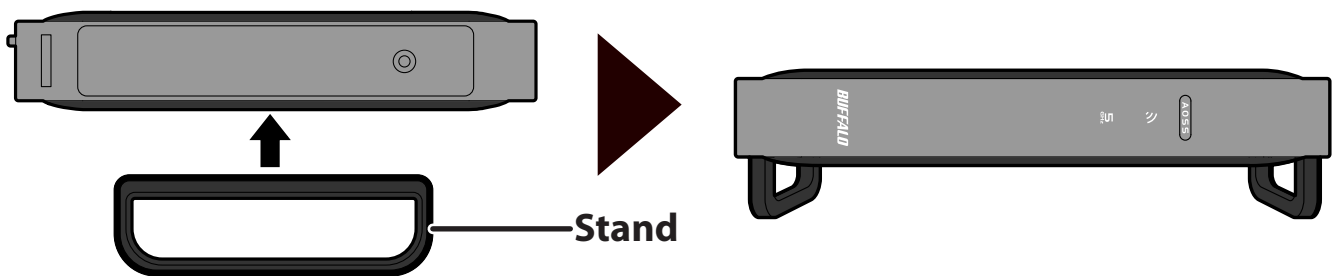

Wall-Mounting

Install with the supplied screws in the mounting holes of the AirStation as shown in the figure below.

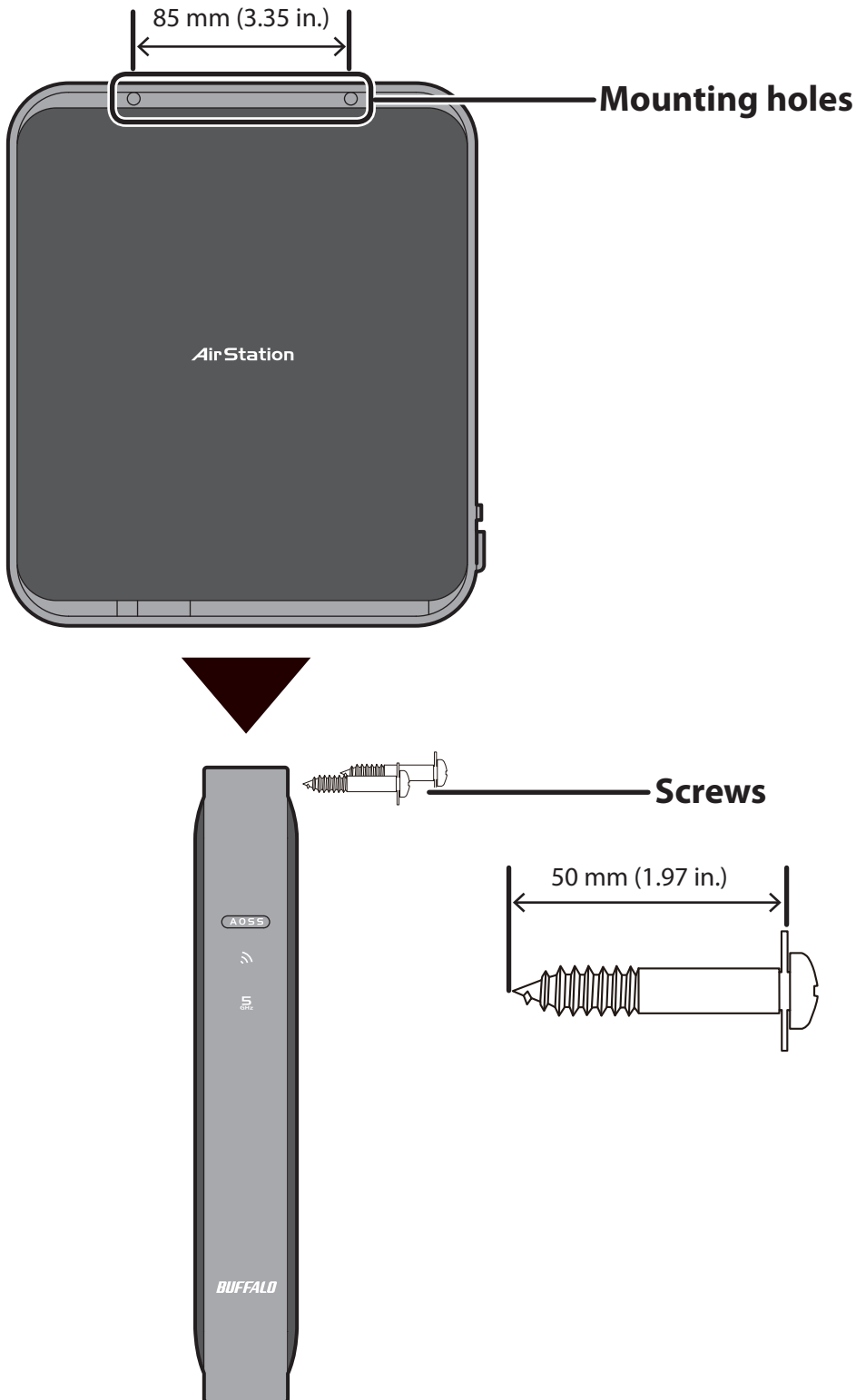

Chapter 2 - Installation

Initial Setup (one-touch connection)

To configure your AirStation, follow the procedure below.

- 1 Turn on the AirStation, then wait one minute.

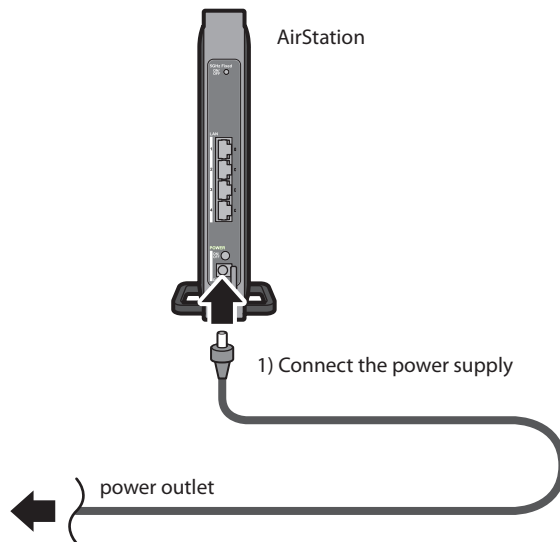

Note : If the power does not turn on even when the AC adapter is connected, press the Power button on the rear of the AirStation.

- 2 Use a LAN cable to connect the LAN port on the AirStation to your computer, television, or other client device.

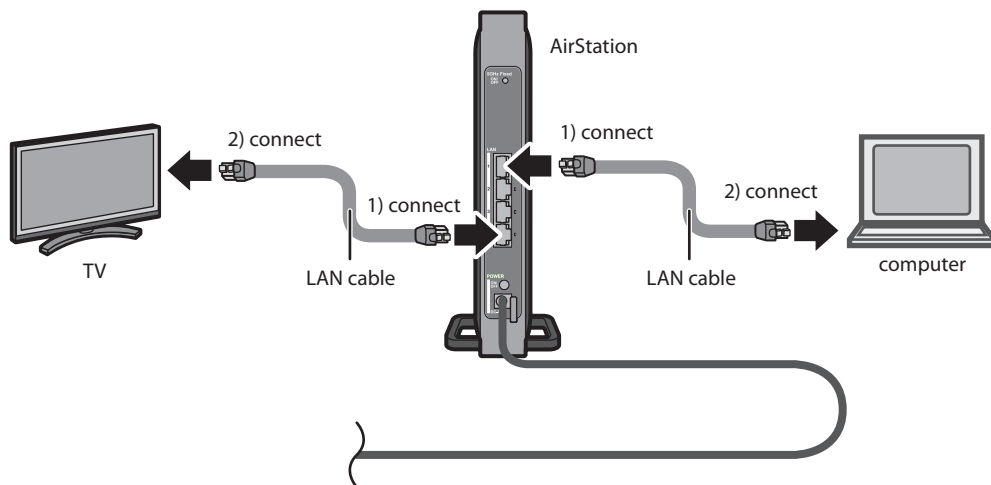

3 Once your computer has booted, the AirStation's LEDs should be lit as described below:

Wireless	On or blinking.
5 GHz	On or off.
Buffalo	White light on.
LAN	Green light on or blinking.

For LED locations, refer to chapter 1.

4 Press the WPS (or AOSS) button of the wireless router that you are currently using.

Note : This example explains how to make a one-touch connection between the AirStation and your wireless router. To make the setting from the configuration interface of the AirStation, see Chapter 3.

5 Press the AOSS/WPS button on the AirStation until the wireless LED button on the front panel starts flashing (about 1 second).

6 After about one minute, check that the Wireless LED on the AirStation's front panel is lit.

Note : If the Wireless LED continues flashing, connection with the wireless router has failed. Perform the procedure again from Step 4.

7 Launch your web browser. If you can connect to the Internet, then setup is completed.

Note : If you cannot connect to the Internet, there may be a problem with the settings of your wireless router. Refer to the manual for your wireless router for help configuring it.

Manual Setup

- 1** Refer to Chapter 3 to open the configuration interface for the AirStation.
- 2** Click [Connect to AirStation (access point)].
- 3** Click [Search].
- 4** Choose your wireless router and click [Select].
- 5** Enter the encryption type and encryption key. Click [Setup].

Note : If you cannot connect to the wireless router, double-check your encryption type and key. These settings must be the same for both the wireless router and the wireless bridge.

Chapter 3 - Configuration

The web-based configuration tool lets you change the AirStation's settings. Don't change these settings unless you know what you're doing.

Installing the Ethernet Converter Manager (Windows)

The Ethernet Converter Manager is required to display the AirStation configuration interface for a Windows computer. Use the procedure below to perform the installation.

1 Load the AirNavigator CD into your computer.

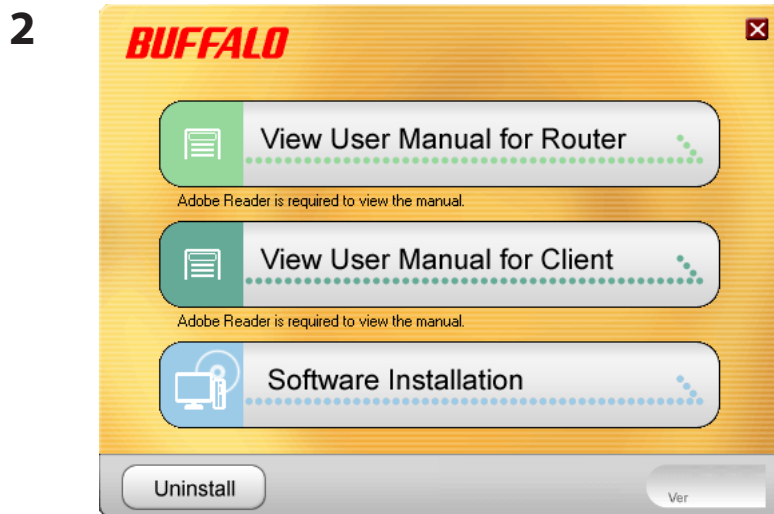

Click [Software installation].

3 Step through the wizard to install the Ethernet Converter Manager software.

Setting the AirStation IP Address (Windows)

The Ethernet Converter Manager can be used to change the IP address of the AirStation. If using a Windows computer, follow the procedure below to set the AirStation's IP address.

- 1 Click [Start] > [All programs] > [BUFFALO] > [AirStation Utility] > [Ethernet Converter Manager].

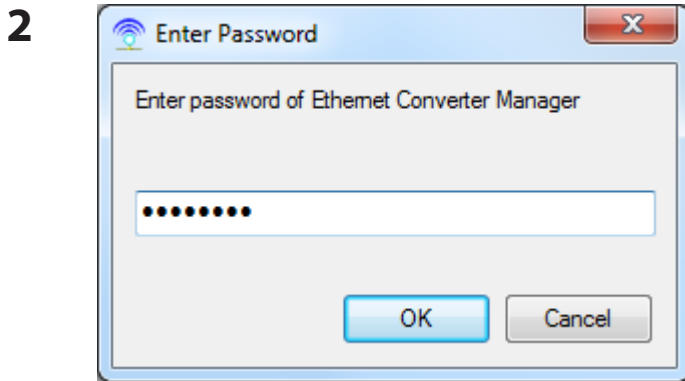

When this screen appears, enter the password, then click [OK].

- Notes:
- By default, the password is "password".
 - If you forget your password, hold down the reset button (page 8) to initialize all settings. The password will then revert to "password". Note that all other settings will also revert to their default values.

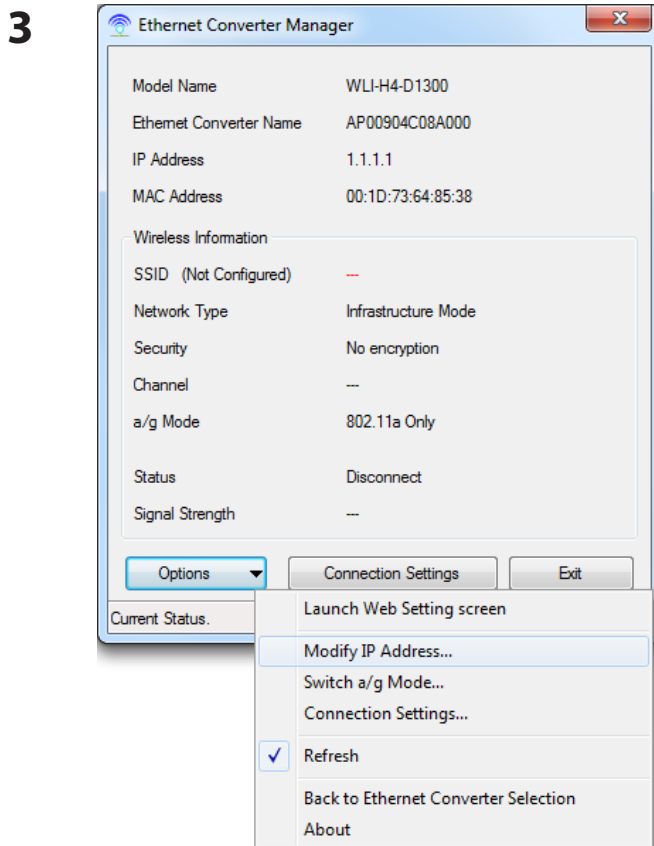

Click [Options] > [Modify IP Address...].

4

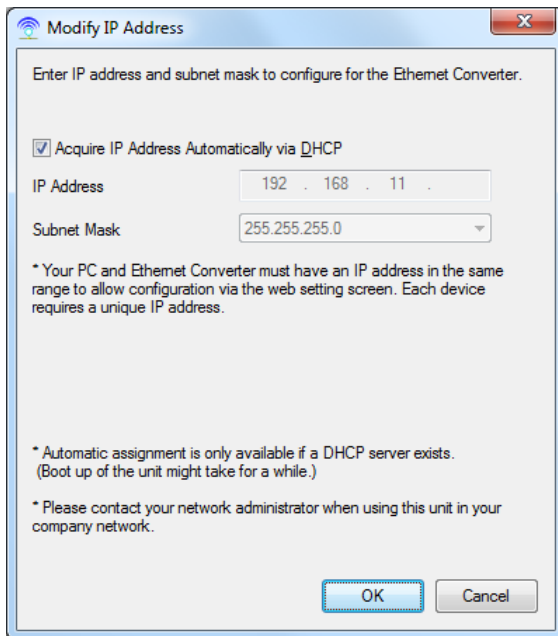

Select "Acquire IP Address Automatically via DHCP", then click [OK].

5

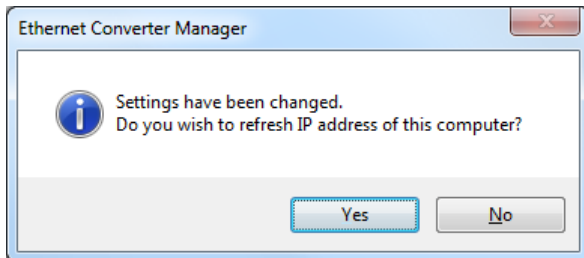

Click [Yes].

Accessing the Web-based Configuration Interface (Windows)

To manually set the AirStation advanced settings from a Windows computer, use the procedure below to log into the AirStation Configuration interface.

- 1 Click [Start] > [All programs] > [BUFFALO] > [AirStation Utility] > [Ethernet Converter Manager].

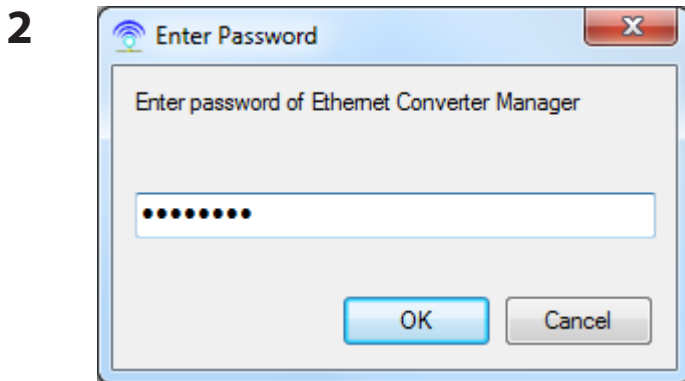

When this screen appears, enter the password, then click [OK].

- Notes:
- By default, the password is "password".
 - If you forget your password, hold down the reset button (page 8) to initialize all settings. The password will then revert to "password". Note that all other settings will also revert to their default values.

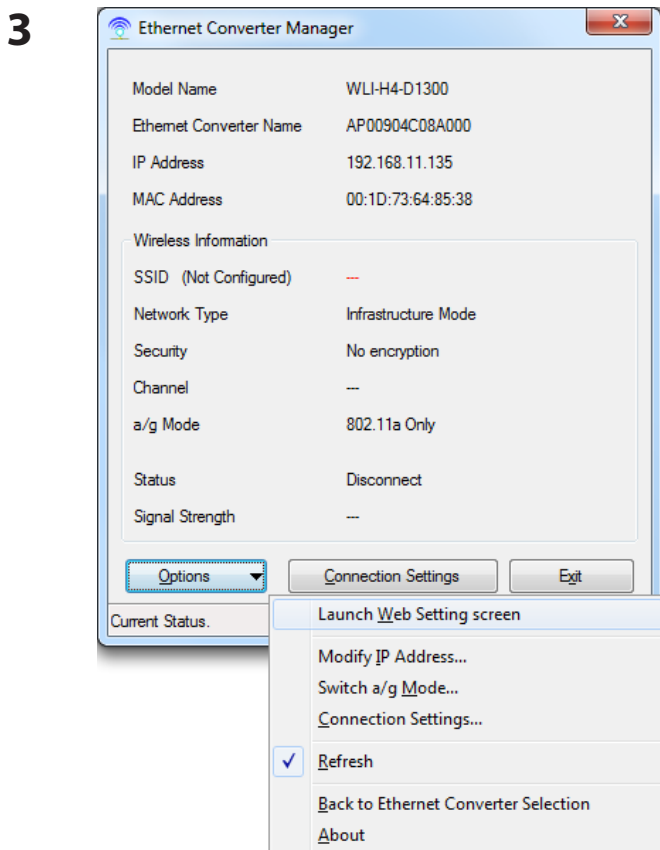

Click [Options] > [Launch Web Setting screen].

4

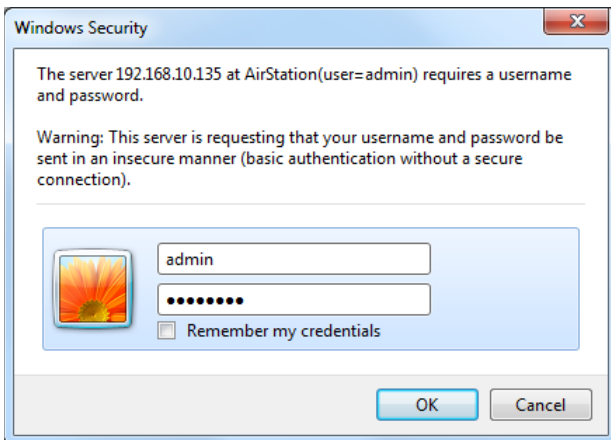

Enter "admin" for the username and "password" for the password, then click [OK].

Note: If the password was changed, enter the new password instead of the default.

5

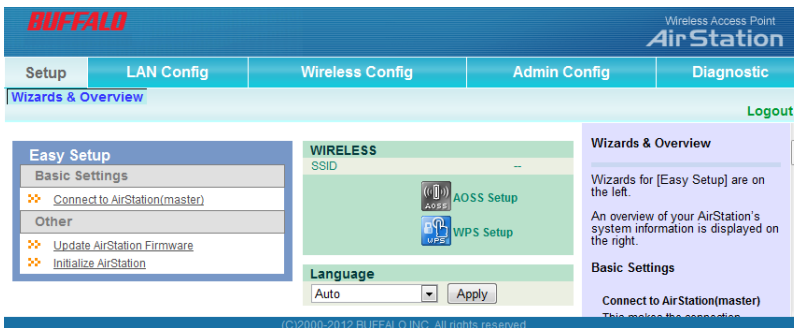

This is the configuration interface, where most wireless media bridge settings can be configured.

Accessing the Web-based Configuration Interface (Mac OS X)

To access the configuration interface of the AirStation from a Mac, the IP address of the AirStation is required. If you do not know the IP address, use the procedure below to access the configuration interface.

Note: If you do not know the IP address of the AirStation, reset the AirStation. All settings will be changed to their default values.

- 1** Click [Apple menu] > [System Preferences...].
- 2** Click [Network].
- 3** Click [Ethernet].
- 4** Select [Manually] in the Configure IPv4 field.

Note: Make a note of the current IP address.

- 5** Set the IP address of the Mac to be on the same subnet as the AirStation. The first three numbers in the IP address should be the same and the fourth different. For example, if the IP address of the AirStation is 1.1.1.1, you could set the IP address of the Mac to 1.1.1.2. Click [Apply].
- 6** Launch your web browser, enter the IP address of the AirStation in the address field, and press the Enter key.
When a screen appears for entering the name and password, enter "admin" in the username field and "password" in the password field, then click [OK].
- 7** When the settings for the AirStation are complete, return the IP address of the Mac to its original setting that was noted in step 4.

Configuration Interface Menus

The following settings may be changed from the configuration interface. Please refer to the pages listed at right for explanations of each item.

Main screen	Descriptions	Page
LAN Config		
LAN	Configure the AirStation's IP address.	Page 22
Wireless Config		
WPS	WPS Status and Settings.	Page 23
AOSS	AOSS Status and Settings.	Page 24
Basic	Configure basic wireless settings.	Page 25
Advanced	Configure advanced wireless settings.	Page 27
WMM	Set priorities for Wireless Multimedia Extensions (Wi-Fi Multimedia).	Page 28
Admin Config		
Name	Configure the AirStation's name.	Page 30
Password	Configure the AirStation's login password for access to the configuration interface.	Page 31
Time / Date	Configure the AirStation's internal clock.	Page 32
NTP	Configure the AirStation to synchronize with an NTP server to automatically set the AirStation's internal clock.	Page 33
Access	Configure access restrictions to the AirStation's configuration screens.	Page 34
Log	Configure a syslog server to manage the AirStation's logs.	Page 35
Save / Restore	Save or restore the AirStation's configuration from a configuration file.	Page 36
Initialize / Restart	Initialize the AirStation or reboot it.	Page 37
Update	Update the AirStation's firmware.	Page 38
Diagnostic		
System Info	View current system information for the AirStation.	Page 39
Logs	Check the AirStation's logs.	Page 40
Packet Info	View all packets transferred by the AirStation.	Page 41
Client Monitor	View all devices currently connected to the AirStation.	Page 42
Ping	Test the AirStation's connection to other devices on the network.	Page 43
Logout		
Click this to log out of the AirStation's configuration interface.		

Setup

Setup is the home page of the configuration interface. You can verify settings and the status of the AirStation here.

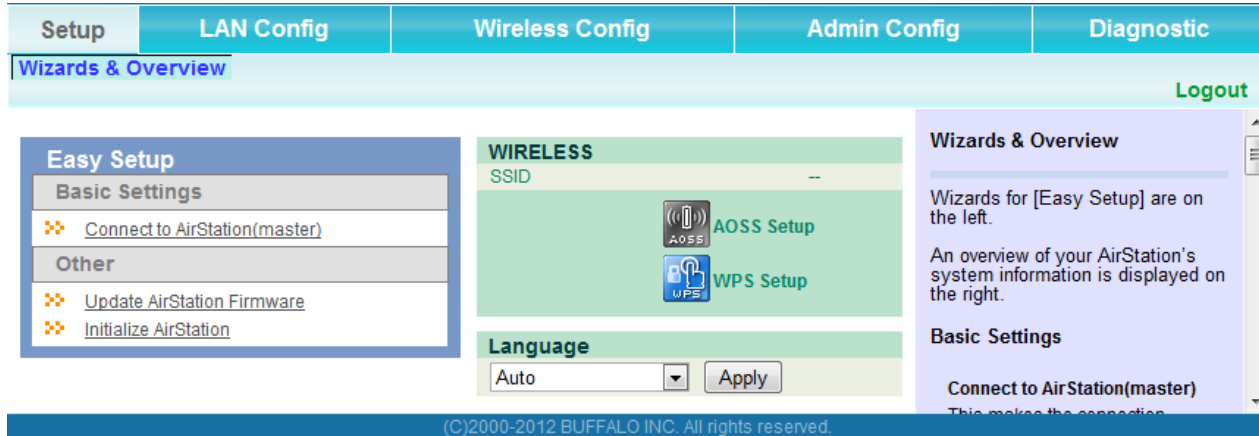

Parameter	Meaning
LAN Config	Displays the configuration screen for the LAN ports.
Wireless Config	Click this button to display the configuration screen for wireless settings.
Admin Config	Click this button to display the configuration screen for administration settings.
Diagnostic	Click this button to display the status of the AirStation.
Easy Setup	Enables you to easily configure the AirStation's network settings automatically.
WIRELESS	Displays the current wireless settings.
AOSS Setup	Click this button to display the AOSS configuration screen.
WPS Setup	Click this button to display the WPS configuration screen.
Language	Enables you to select the language you use.
Logout	Log out of the configuration interface. If the AirStation does not communicate for 5 minutes, it will log out automatically.

LAN Config

LAN

Configure LAN-side settings.

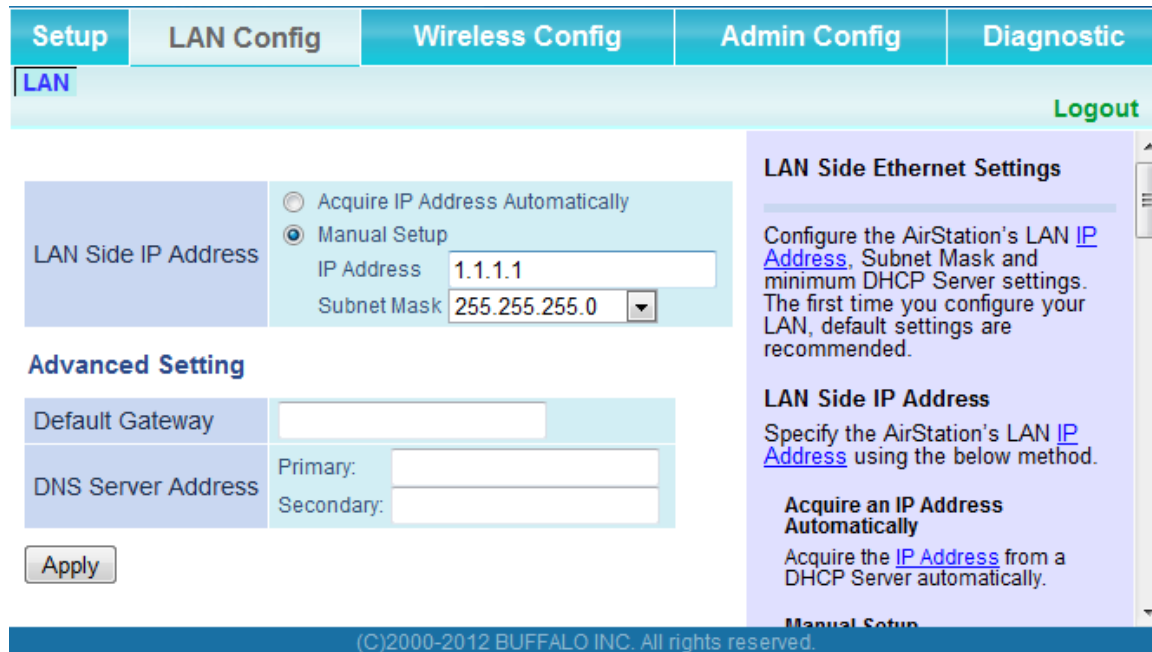

Parameter	Meaning
LAN Side IP Address	By default, the LAN side IP address is 1.1.1.1 with subnet mask 255.255.255.0. You may change it here.
Default Gateway	Set the default gateway IP address.
DNS Server Address	Set the DNS server IP address.

Wireless Config

WPS

WPS Status and Settings.

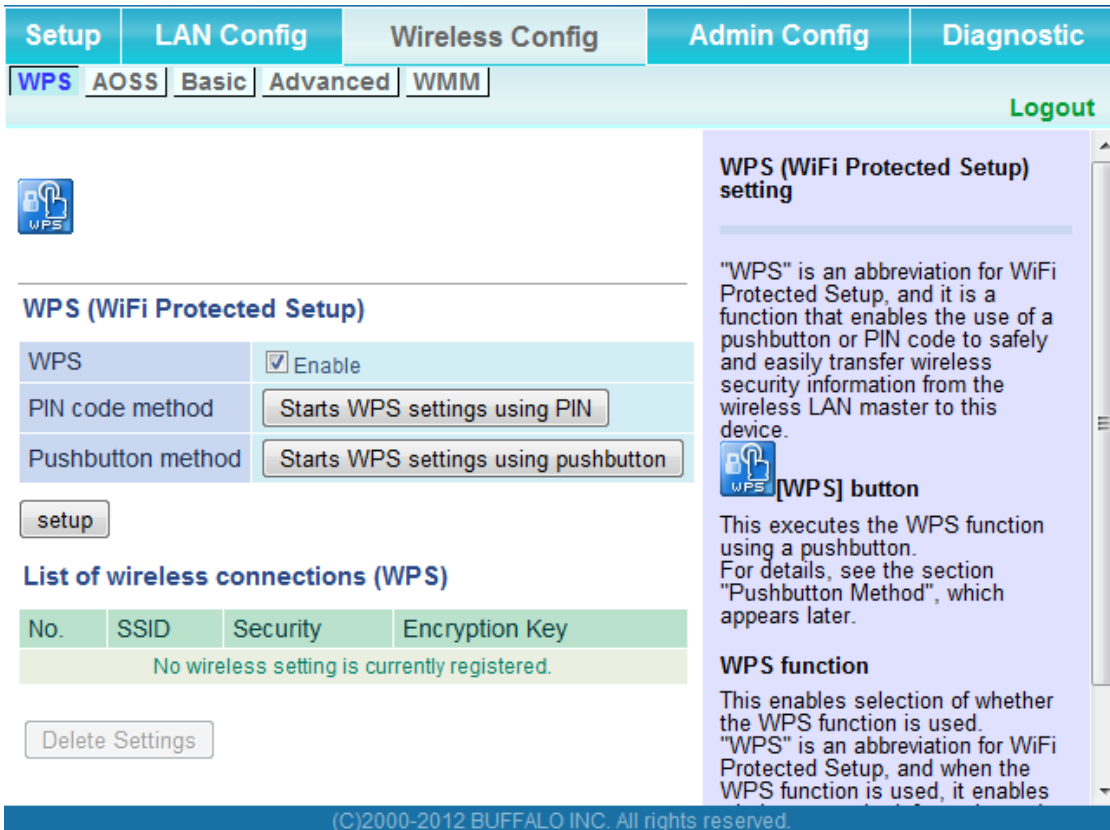

WPS (WiFi Protected Setup) setting

WPS Enable

PIN code method

Pushbutton method

List of wireless connections (WPS)

No.	SSID	Security	Encryption Key
No wireless setting is currently registered.			

WPS (WiFi Protected Setup) setting

"WPS" is an abbreviation for WiFi Protected Setup, and it is a function that enables the use of a pushbutton or PIN code to safely and easily transfer wireless security information from the wireless LAN master to this device.

 **[WPS] button**

This executes the WPS function using a pushbutton. For details, see the section "Pushbutton Method", which appears later.

WPS function

This enables selection of whether the WPS function is used. "WPS" is an abbreviation for WiFi Protected Setup, and when the WPS function is used, it enables

(C)2000-2012 BUFFALO INC. All rights reserved.

Parameter

Meaning



WPS

Initiates WPS automatic wireless configuration. Click this, then press or click the WPS button on your WPS-compatible wireless router.

PIN cord method

Enable to use WPS automatic configuration.

This uses the WPS PIN code system to obtain wireless security information from the wireless access point.

Push button method



This uses the WPS Push Button method to obtain wireless security information from the wireless access point.

List of wireless connections (WPS)

Displays the wireless security information of the wireless connection where the WPS function was used to set security.

AOSS

AOSS Status and Settings.

Parameter	Meaning
	Initiates AOSS automatic wireless configuration. Click this, then press or click the AOSS button on your AOSS-compatible wireless router.
	Click this button to disconnect AOSS connections.
Encryption Type	Displays the Security Level setting for AOSS.
AOSS Button on the AirStation Unit	Uncheck to disable the physical AOSS button on the AirStation.
AOSS Client Information	Displays AOSS clients connected to the AirStation and information of the devices which are wirelessly communicated.

Basic

Configure basic wireless settings from here.



Parameter	Meaning
SSID	The SSID may contain 1 - 32 alphanumeric characters.
Wireless authentication	Specifies the authentication method used when connecting to a wireless router.
Encryption for wireless	<p>You may use any of the following types of encryption:</p> <p>Not encrypted Data is transmitted without encryption. With this setting, anyone within range can connect to your wireless network and might be able to access data on the network. Not recommended for anyone with private data that needs to be kept secure. [Not encrypted] can be selected only when [Do not authenticate] is selected for wireless authentication.</p> <p>WEP WEP is a common encryption method supported by most devices. WEP can only be selected when wireless authentication is set to [Do not authenticate]. Note that WEP's encryption is weak, and networks protected with WEP are not much more secure than those with no encryption at all. Not recommended for anyone with private data that needs to be kept secure.</p> <p>TKIP TKIP is an encryption method which is more secure than WEP, but slower. Use an pre-shared key to communicate with a wireless device. TKIP can be selected only when WPA-PSK or WPA2-PSK is selected for wireless authentication.</p>

Parameter	Meaning
	AES AES is more secure than WEP, and faster. Use a pre-shared key to communicate with a wireless device. AES can be selected only when WPA-PSK or WPA2-PSK is selected for wireless authentication.
WPA-PSK (Pre-Shared Key)	A pre-shared key or passphrase is the password for your wireless connections. There are two different formats for a pre-shared key. Use 8 to 63 alphanumeric characters (case-sensitive) for an ASCII passphrase, or use 64 alphanumeric characters (0 to 9 and a to f, not case-sensitive) for a hexadecimal passphrase.
WEP encryption key setting	A WEP encryption key (passphrase) may have any of four different formats. An ASCII passphrase may use either 5 or 13 alphanumeric characters (case-sensitive). A hexadecimal passphrase may use either 10 or 26 alphanumeric characters (0 to 9 and a to f, not case-sensitive).
11A/11G selection	This specifies the band used when connecting with the wireless access router. Automatic (11a priority) First, a connection is tried at 802.11a, and if a connection cannot be made, a connection is tried at 802.11g. Automatic (11bg priority) First, a connection is tried at 802.11g, and if a connection cannot be made, a connection is tried at 802.11a. 11a only Only 802.11a connections are allowed. Even if an 802.11a connection cannot be made, 802.11g is not used. 11bg only Only 802.11g connections are allowed. Even if an 802.11g connection cannot be made, 802.11a is not used.

Advanced

Configure advanced wireless settings.

The screenshot shows a web-based configuration interface with a top navigation bar containing 'Setup', 'LAN Config', 'Wireless Config', 'Admin Config', and 'Diagnostic'. Below this, a sub-menu includes 'WPS', 'AOSS', 'Basic', 'Advanced', and 'WMM'. The 'Advanced' tab is selected. The main content area is divided into two columns. The left column contains the following settings:

- MAC Address for wireless communication: Unit Address (dropdown menu)
- 802.11n Protection: Enable
- Output Power: 100 % (dropdown menu)
- Request of multicast translation: Enable

An 'Apply' button is located below these settings. The right column is a sidebar titled 'Advanced Wireless Settings (11ac/n/a/11n/g/b)'. It contains the text 'Specify Advanced Wireless Settings.' and a section titled 'MAC Address for wireless communication' with the instruction 'Select MAC address for wireless communication.' and a dropdown menu labeled 'Unit Address'.

At the bottom of the interface, a copyright notice reads: (C)2000-2012 BUFFALO INC. All rights reserved.

Parameter	Meaning
MAC Address for wireless communication	Select which MAC address is used for wireless communication.
802.11n protection	Enable to use 802.11n protection. 802.11n protection gives priority to 802.11n devices in mixed mode (11b/g or 11a) networks.
Output Power	This sets the output of the wireless signal. Because the wireless transmission output and signal distance range are nearly proportional, when the wireless transmission output is reduced, the signal distance range also becomes shorter.
Request of multicast translation	Specific multicast data (such as video broadcast data) can be transferred at high speeds to an access point that supports the multicast control.

WMM

Set priorities for specific communications.

Setup
LAN Config
Wireless Config
Admin Config
Diagnostic

WPS
AOSS
Basic
Advanced
WMM
Logout

WMM-EDCA Parameters

Please do not change the setting usually.

Priority	Parameter	For AP		For STA	
		Value	Unit	Value	Unit
AC_BK (Low)	CWmin:	15		15	
	CWmax:	1023		1023	
	AIFSN:	7		7	
	TXOP Limit:	0		0	
	Admission Control:	---		Disable	▼
AC_BE (Normal)	CWmin:	15		15	
	CWmax:	63		1023	
	AIFSN:	3		3	
	TXOP Limit:	0		0	
	Admission Control:	---		Disable	▼
AC_VI (High)	CWmin:	7		7	
	CWmax:	15		15	
	AIFSN:	1		2	
	TXOP Limit:	94		94	
	Admission Control:	---		Disable	▼
AC_VO (Highest)	CWmin:	3		3	
	CWmax:	7		7	
	AIFSN:	1		2	
	TXOP Limit:	47		47	
	Admission Control:	---		Disable	▼

WMM Settings (11ac/n/a/11n/g/b)

Prioritized AirStation communication for specific transactions. This settings provides some real time communication, which can help improve the quality of VOIP or other streaming protocols.

WMM-EDCA Parameters

It is usually not necessary to change this value.

Priority

The priority is ranked (Highest)8 : (High)4 : (Normal)2 : (Low)1 for each packet.

Parameter

CWmin, CWmax
The maximum and minimum value for the contention window. The contention window is used to control the frame collision avoidance system in IEEE802.11. Values that can be inputted: 1-32767.

AIFSN
Interval of the sending frame. The unit defines a time-slot (similar to the window value of CWmin, CWmax). Lower values define a higher priority as the back-off algorithm starts earlier. Values that can be inputted: 1-15.

TXOP Limit
The time for the queue to obtain send priority. The minimum value is 32ms. Large values can send more frames at a time. However, later settings are...

(C)2000-2012 BUFFALO INC. All rights reserved.

Parameter	Meaning
WMM-EDCA Parameters	<p data-bbox="639 321 1446 390">You don't usually need to change these settings. Using the default settings is recommended.</p> <p data-bbox="639 422 740 453">Priority</p> <p data-bbox="662 457 1446 600">The following priorities may be applied to individual transmission packets: (Highest) 8, (High) 4, (Normal) 2, and (Low) 1. From the queue, these packets are processed in order of priority.</p> <p data-bbox="639 632 846 663">CWmin, CWmax</p> <p data-bbox="662 667 1446 846">The maximum and minimum value of the contention window. The contention window is used in the frame collision avoidance structure performed in IEEE802.11, and generally, the smaller the value in the window, the higher the probability that the queue obtains the right to send.</p> <p data-bbox="639 877 719 909">AIFSN</p> <p data-bbox="662 913 1446 1056">The interval to send frames. The unit of the AIFSN is a slot, just as the window defined by CWmin and CWmax is. The smaller the interval of sending frames, the faster the algorithm can restart. As a result, the priority of the queue is higher.</p> <p data-bbox="639 1087 784 1119">TXOP Limit</p> <p data-bbox="662 1123 1446 1302">The period of time that the queue can use after obtaining the right to send. The unit is 32 ms. The longer this time, the more frames can be sent per right to send. However, the queue may interfere with other packet transmissions. If TXOP Limit is set to 0 (zero), only one frame can be sent per right to send.</p> <p data-bbox="639 1333 881 1365">Admission Control</p> <p data-bbox="662 1369 1446 1470">Restricts new frames from interfering with a previous queue. New packets are prioritized lower until a queue of them is collected. As the new queue accumulates more packets, its priority increases.</p>

Admin Config

Name

Configure basic AirStation settings.

The screenshot shows a web interface with a navigation menu at the top containing 'Setup', 'LAN Config', 'Wireless Config', 'Admin Config', and 'Diagnostic'. Below the menu is a sub-menu with 'Name', 'Password', 'Time/Date', 'NTP', 'Access', 'Log', 'Save/Restore', 'Initialize/Restart', and 'Update'. The 'Name' sub-menu item is selected. On the right side, there is a 'Logout' link. The main content area is titled 'AirStation Name' and contains a text input field with the value 'AP00904C08A000' and an 'Apply' button. A help box on the right explains that the name can be used to assign a specific descriptive name for the AirStation. At the bottom, there is a copyright notice: '(C)2000-2012 BUFFALO INC. All rights reserved.'

Parameter	Meaning
AirStation Name	Enter a name for the AirStation. Names may include up to 64 alphanumeric characters and hyphens (-).

Password

Configure the password to log in to the AirStation's configuration interface.

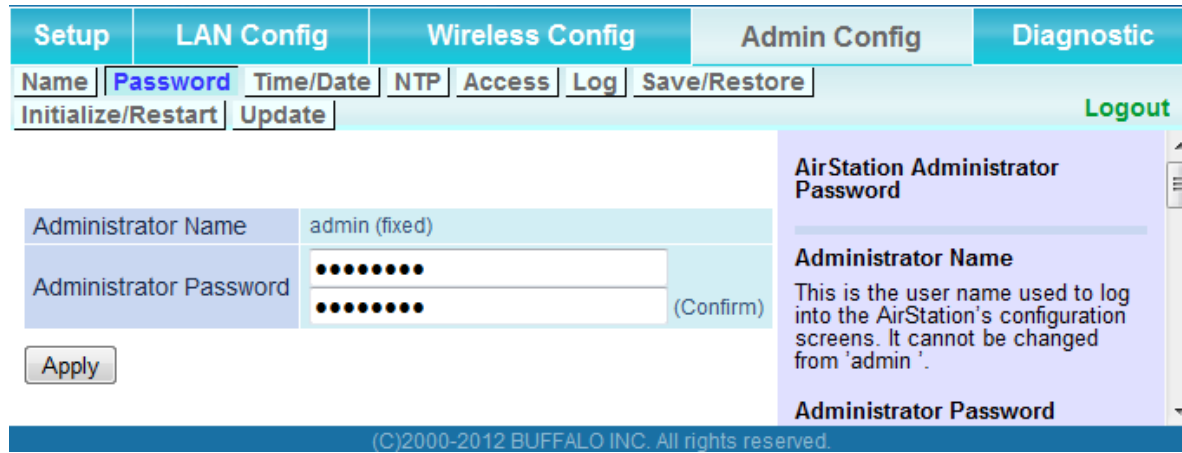

The screenshot shows the configuration interface with the following elements:

- Navigation Tabs:** Setup, LAN Config, Wireless Config, Admin Config (selected), Diagnostic.
- Sub-Tabs:** Name, Password (selected), Time/Date, NTP, Access, Log, Save/Restore, Initialize/Restart, Update, Logout.
- Form Fields:**
 - Administrator Name: admin (fixed)
 - Administrator Password: [Masked]
 - Administrator Password (Confirm): [Masked]
- Buttons:** Apply
- Help Panel (Right):**
 - AirStation Administrator Password**
 - Administrator Name**: This is the user name used to log into the AirStation's configuration screens. It cannot be changed from 'admin'.
 - Administrator Password**
- Footer:** (C)2000-2012 BUFFALO INC. All rights reserved.

Parameter	Meaning
Administrator Name	The name of the Administrator account is "admin".
Administrator Password	The Administrator password may contain up to 8 alphanumeric characters and underscores (_).

Time/Date

Configure the AirStation's internal clock.

Parameter	Meaning
Local Date	You may manually set the date of the AirStation's internal clock.
Local Time	You may manually set the time of the AirStation's internal clock.
Time Zone	Specify the time zone (offset of Greenwich Mean Time) of the AirStation's internal clock.
DST (Daylight Saving Time)	You may configure the AirStation to automatically use DST (Daylight Saving Time). If selected, the AirStation will automatically adjust the time at the beginning and end of DST.

NTP

Configure an NTP server to automatically synchronize the AirStation’s internal clock.

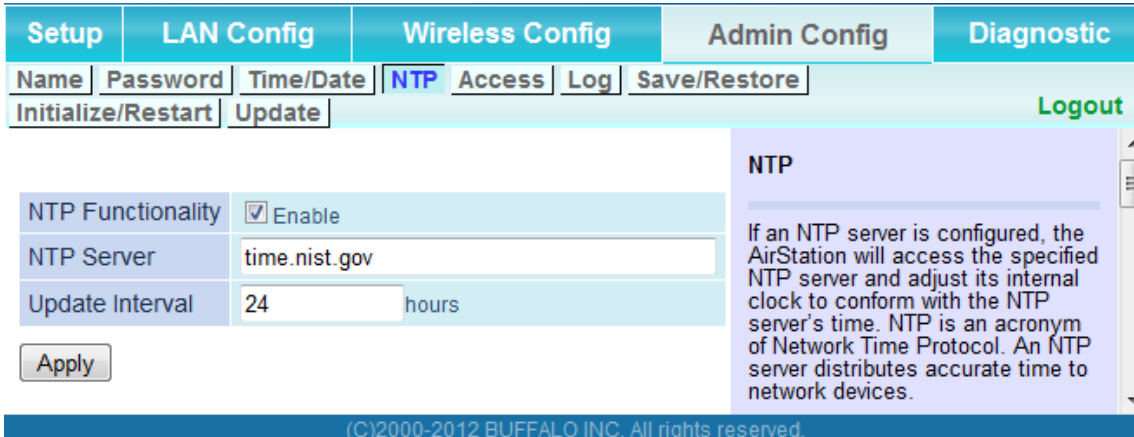

The screenshot shows the configuration page for NTP. The 'NTP Functionality' checkbox is checked. The 'NTP Server' field contains 'time.nist.gov'. The 'Update Interval' is set to '24' hours. An 'Apply' button is located below the form. A help box on the right side of the page provides a definition of NTP: 'If an NTP server is configured, the AirStation will access the specified NTP server and adjust its internal clock to conform with the NTP server's time. NTP is an acronym of Network Time Protocol. An NTP server distributes accurate time to network devices.'

Parameter	Meaning
NTP Functionality	Enable to use an NTP server. The default is Enabled.
NTP Server	Enter the name of the NTP server as a hostname, hostname with domain name, or IP address. Up to 255 alphanumeric characters, hyphens (-), and underscores (_) may be used. The default is "time.nist.gov".
Update Interval	How often will the AirStation check the NTP server for the correct time? Intervals of 1 - 24 hours may be set. The default is 24 hours.

Access

Restrict access to the AirStation's configuration interface.

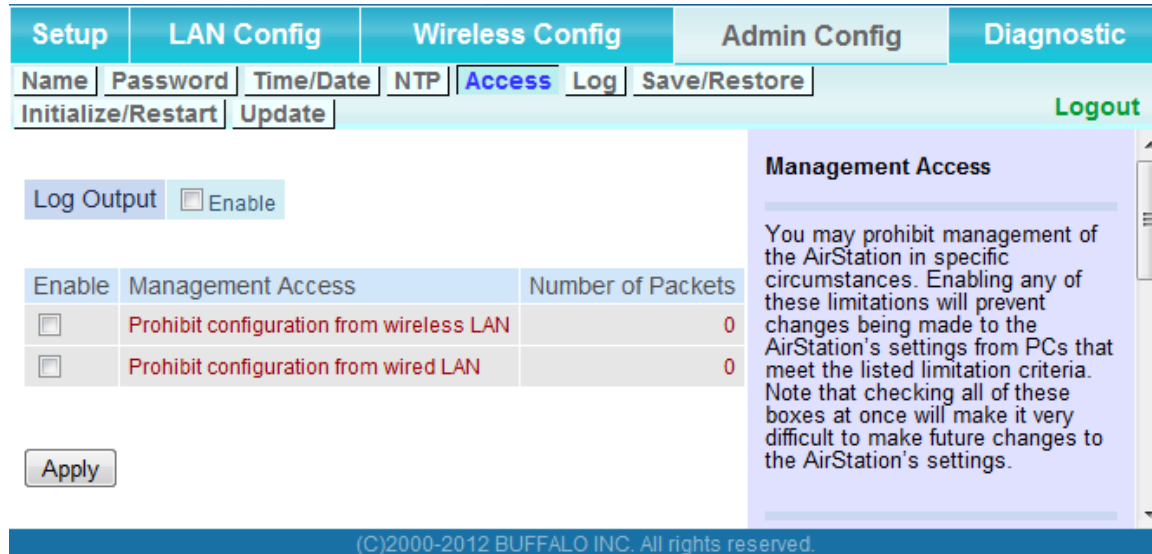

Setup LAN Config Wireless Config Admin Config Diagnostic

Name Password Time/Date NTP Access Log Save/Restore Logout

Initialize/Restart Update

Log Output Enable

Enable	Management Access	Number of Packets
<input type="checkbox"/>	Prohibit configuration from wireless LAN	0
<input type="checkbox"/>	Prohibit configuration from wired LAN	0

Apply

Management Access

You may prohibit management of the AirStation in specific circumstances. Enabling any of these limitations will prevent changes being made to the AirStation's settings from PCs that meet the listed limitation criteria. Note that checking all of these boxes at once will make it very difficult to make future changes to the AirStation's settings.

(C)2000-2012 BUFFALO INC. All rights reserved.

Parameter	Meaning
Log Output	Enabling outputs a log of changes to access settings.
Prohibit configuration from wireless LAN	If enabled, prevents access to configuration interface from wirelessly connected devices (only wired devices may configure).
Prohibit configuration from wired LAN	If enabled, prevents access to configuration interface from wired devices (only wirelessly connected devices may configure).

Log

Transfer the AirStation's logs to a syslog server.

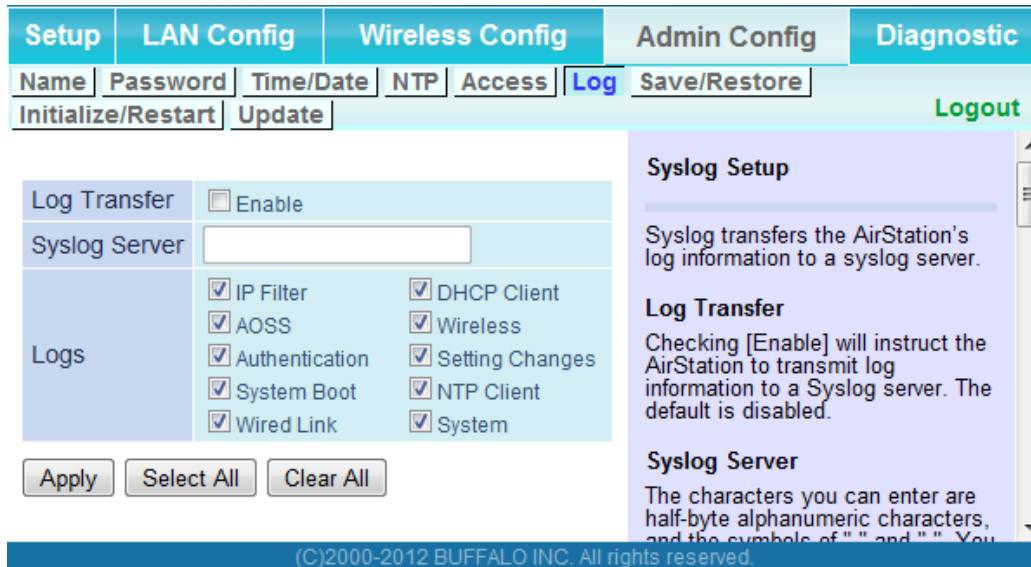

Parameter	Meaning
Log Transfer	Enable to send logs to a syslog server.
Syslog Server	Identify the syslog server by hostname, hostname with domain name, or IP address. You may enter up to 255 alphanumeric characters, hyphens (-), and underscores (_).
Logs	Choose which logs will be transferred to the syslog server.

Save/Restore

Save AirStation settings as a file and restore from them later.

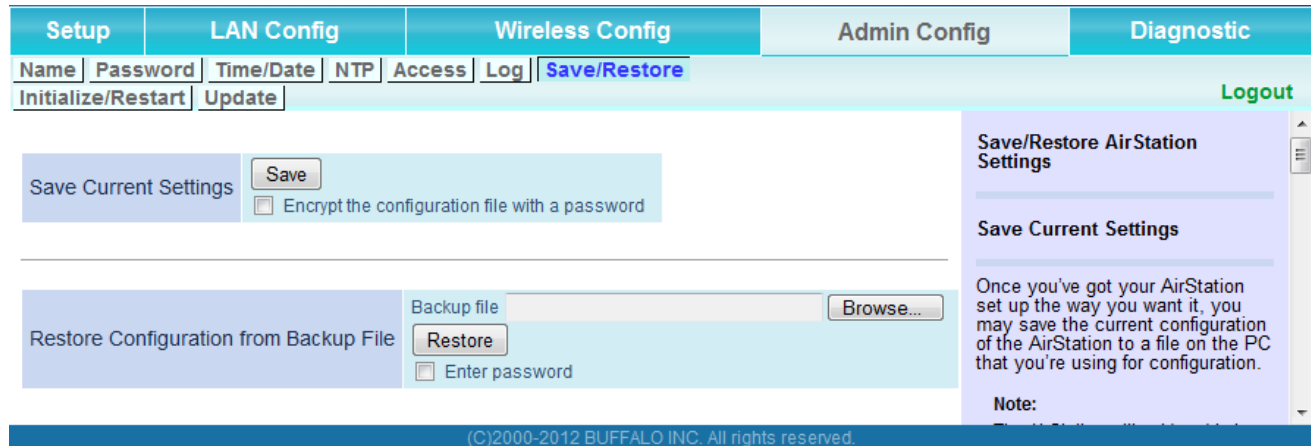

Parameter	Meaning
Save current settings	Clicking [Save] will save the current configuration of the AirStation to a file. If the [Encrypt the configuration file with a password] option is checked, then the configuration file will be password protected with the current administrator password.
Restore Configuration from Backup File	Restore the configuration of the AirStation from a saved configuration file by clicking the [Browse...], navigating to the configuration file, and then clicking [Restore]. If the configuration file was password protected, then put a check next to [Enter password], enter the password, and click [Open].

Initialize/Restart

Initialize or restart the AirStation.

The screenshot shows a web-based configuration interface for an AirStation. At the top, there are navigation tabs: Setup, LAN Config, Wireless Config, Admin Config, and Diagnostic. Below these are sub-tabs: Name, Password, Time/Date, NTP, Access, Log, Save/Restore, and Logout. The 'Initialize/Restart' sub-tab is selected. The main content area is divided into two columns. The left column contains two sections: 'Restart' with the description 'This reboots your AirStation.' and a 'Restart Now' button; and 'Initialize' with the description 'This will restore your AirStation to the factory default settings.' and an 'Initialize Now' button. The right column is a sidebar with a scrollable list containing 'Initialize/Restart' and 'Restart'. Below the sidebar, there is a footer with the text '(C)2000-2012 BUFFALO INC. All rights reserved.'

Parameter	Meaning
Restart	Click [Restart Now] to restart the AirStation.
Initialize	Click [Initialize Now] to initialize and restart the AirStation.

Update

Update the AirStation's firmware.

Setup	LAN Config	Wireless Config	Admin Config	Diagnostic
Name	Password	Time/Date	NTP	Access
Log	Save/Restore			Logout
Initialize/Restart	Update			

Firmware Version	WLI-H4-D1300 Ver.1.86
Update Method	<input checked="" type="radio"/> Specify Local File <input type="radio"/> Auto Update Online
Firmware File Name	<input type="text"/> <input type="button" value="Browse..."/>
<input type="button" value="Update Firmware"/> <input type="button" value="Version Check"/>	

*Get updated firmware files from our website:
[Download Service](#)

[Advanced Settings]

If the time of the AirStation is not set beforehand, the scheduling function will not work properly.

Firmware Update Reminder	<input checked="" type="checkbox"/> Enable
Remind Time	Automatic

(C)2000-2012 BUFFALO INC. All rights reserved.

Parameter	Meaning
Firmware Version	Displays the current firmware version of the AirStation.
Update Method	<p>Specify Local File Updates from a firmware file stored on your computer.</p> <p>Automatic Update Online Automatically updates to the latest firmware available.</p>
Firmware File Name	Click [Browse...] to navigate to the firmware file on your computer if [Specify Local File] was selected. You don't need to specify the firmware location if you're using [Automatic Update]. Click [Update Firmware] to update the firmware.
Firmware update Reminder	Specify Enable/Disable Firmware Update Reminder.
Remind Time	Specify the time when the system detects new firmware.

Diagnostic

System Info

View system information for the AirStation.

Setup	LAN Config	Wireless Config	Admin Config	Diagnostic
System Info	Logs	Packet Info	Client Monitor	Ping
				Logout

Model	WLI-H4-D1300 Ver.1.86 (R1.44/B6.30.15-0.22-0.10)		
AirStation Name	AP00904C08A000		
LAN	Method of Acquiring IP Address	Manual Setting	
	IP Address	192.168.11.135	
	Subnet Mask	255.255.0.0	
	Default Gateway	Not Set	
	DNS (Primary)	Not Set	
	DNS (Secondary)	Not Set	
	MTU Size	1500	
	MAC Address	00:90:4C:08:A0:00	
Wireless	SSID	BUFFALO-123456 (Manual)_A	
	Authentication Encryption	WPA2-PSK AES	
	MAC Address for wireless communication[Multiple Client]		
	Wireless Channel	802.11ac/n/a : 40Channel	
	Wireless Status	100% (270Mbps)	
	MAC Address	00:1D:73:64:80:94	

System Information

Displays the AirStation's main settings.

Model
Displays the model name and firmware version of the AirStation.

AirStation Name
Displays the AirStation's host name.

LAN
AirStation LAN information.

IP Address
IP address acquisition.

Connection Status
Display the current LAN port status under DHCP configuration.

Operation
DHCP configuration. If DHCP is in use, the following commands can be executed.

- [Release] : Releases the IP address assigned by the DHCP Server.
- [Renew] : Renews the IP address from the DHCP Server.

(C)2000-2012 BUFFALO INC. All rights reserved.

Parameter	Meaning
Model	Displays the product name of the AirStation and the firmware version.
AirStation Name	Displays the name of the AirStation.
LAN	Displays information about the LAN port.
Wireless	Displays the wireless status.

Logs

The AirStation's logs are recorded here.

The screenshot shows the 'Logs' configuration page. At the top, there are navigation tabs: Setup, LAN Config, Wireless Config, Admin Config, and Diagnostic. Under 'LAN Config', there are sub-tabs: System Info, Logs, Packet Info, Client Monitor, and Ping. A 'Logout' button is in the top right. The main content area is divided into two columns. The left column has a 'Display log info' section with a grid of checkboxes for selecting log types: IP Filter, DHCP Client, AOSS, Wireless Client, Authentication, Setting Changes, System Boot, NTP Client, Wired Link, and System. Below this are 'Display', 'Select All', and 'Clear All' buttons. The 'Logs' section below has a 'Save to file logfile.log.' button and a 'Delete' button. A table shows log entries with columns 'Date Time', 'Type', and 'Log Content'. The right column contains a 'Logs' section with instructions: 'Display log information recorded in the AirStation. The oldest information is overwritten by new logs.' and 'Display log info' instructions: 'Select the types of information that should be logged by the AirStation. The default is All. The following items can be selected:' followed by a bulleted list of log types: IP Filter, DHCP Client, AOSS, Wireless Client (Start/stop and client connection), Authentication, Setting Changes, and System Boot. At the bottom, there is a copyright notice: '(C)2000-2012 BUFFALO INC. All rights reserved.'

Parameter	Meaning
Display log info	Choose the types of logs to display.
Logs	Displays the log information recorded in the AirStation.

Packet Info

View packet transfer information.

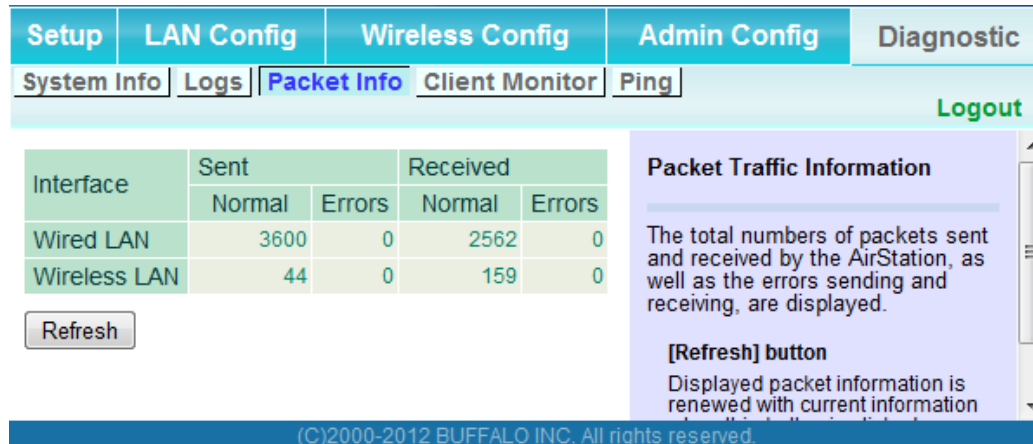

Interface	Sent		Received	
	Normal	Errors	Normal	Errors
Wired LAN	3600	0	2562	0
Wireless LAN	44	0	159	0

Refresh

Packet Traffic Information

The total numbers of packets sent and received by the AirStation, as well as the errors sending and receiving, are displayed.

[Refresh] button
Displayed packet information is renewed with current information

(C)2000-2012 BUFFALO INC. All rights reserved.

Parameter	Meaning
Sent	Displays the number of packets sent to the wired LAN and the wireless LAN.
Received	Displays the number of packets received from the wired LAN and the wireless LAN.

Client Monitor

This screen shows devices that are connected to the AirStation.

MAC Address	Communication Method	Wireless Authentication	802.11n
00:1D:73:64:80:94	Wired	-	-
00:90:4C:08:A0:00	Wired	-	-
E0:69:95:2E:1F:DB	Wired	-	-

Refresh

Client Monitor
 Displays the LAN side clients (PCs) that are accessing the AirStation.
 The following information is displayed:
MAC Address
 Shows client's MAC address

(C)2000-2012 BUFFALO INC. All rights reserved.

Parameter

Meaning

Client Monitor

Displays information (MAC address, communication method, wireless authentication and 802.11n) for devices that are connected to the AirStation.

Ping

A ping test checks whether the AirStation can communicate with a specific network device.

The screenshot shows the 'Ping' configuration page in the AirStation web interface. The navigation menu includes 'Setup', 'LAN Config', 'Wireless Config', 'Admin Config', and 'Diagnostic'. Under 'Diagnostic', the 'Ping' sub-menu is selected. The main content area features a 'Destination Address' input field, an 'Execute' button, and a 'Result' section displaying three successful ping results to 192.168.11.135. A help box on the right explains the Ping test and provides examples of destination addresses.

Parameter	Meaning
Destination Address	Enter the IP address or hostname of the device that you are testing communication with, then click [Execute]. The result will be displayed below.

Chapter 4 - TroubleShooting

When connection to a wireless router is not possible

- Turn the power for the wireless router off and then on again.
- If the “5 GHz fixed mode” is enabled, turn it off.
- Refer to Chapter 2 to connect this unit to a wireless router.
- Move this unit closer to the wireless router.
- Make sure that your client devices are configured to “obtain an IP address automatically from DHCP”.
- Verify that your web browser is not set to use proxies.
- Restart your wireless router and AirStation.

You forgot the SSID, encryption key, or password for the wireless network.

- Ask your network administrator about your SSID and encryption settings. These settings must match the SSID and encryption settings of the wireless router.
- If your wireless router supports AOSS or WPS, try using them to connect to the wireless router. Instructions for connecting with AOSS or WPS are in page 12.

Restoring the Default Configuration



With the AirStation powered on, hold down this button for 3 seconds to return it to factory default settings.

TCP/IP Settings (Windows 7)

To configure TCP/IP in Windows 7, follow the procedure below.

- 1** Click [Start] > [Control Panel] > [Network and Internet].
- 2** Click [Network and Sharing Center].
- 3** Click [Change Adapter Settings] on the left side menu.
- 4** Right-click on [Local Area Connection], then click [Properties].
- 5** If the User Account Control screen opens, click [Yes] or [Continue].
- 6** Select [Internet Protocol Version 4 (TCP/IPv4)] then click [Properties].
- 7** To have DHCP set your IP address settings automatically, check [Obtain an IP address automatically] and [Obtain DNS server address automatically].

To set your IP address settings manually, enter values for each setting. Examples:

If your AirStation's IP address is 1.1.1.1,	
IP address	1.1.1.2
Subnet mask	255.255.255.0
Default gateway	blank
Preferred DNS server	blank
Alternate DNS server	blank

- 8** Click [OK].

TCP/IP Settings (Windows Vista)

To configure TCP/IP in Windows Vista, follow the procedure below.

- 1** Click [Start] > [Settings] > [Control Panel].
- 2** Click [Network and Sharing Center].
- 3** Click [Manage network connections] on the left side menu.
- 4** Right-click on [Local Area Connection], then click [Properties].
- 5** If the User Account Control screen opens, click [Yes] or [Continue].
- 6** Select [Internet Protocol Version 4 (TCP/IPv4)], then click [Properties].
- 7** To have DHCP set your IP address settings automatically, check [Obtain an IP address automatically] and [Obtain DNS server address automatically].

To set your IP address settings manually, enter values for each settings. Example:

If your AirStation's IP address is 1.1.1.1,	
IP address	1.1.1.2
Subnet mask	255.255.255.0
Default gateway	blank
Preferred DNS server	blank
Alternate DNS server	blank

- 8** Click [Close].

TCP/IP Settings (Windows XP)

To configure TCP/IP in Windows XP, follow the procedure below.

- 1** Click [Start] > [Settings] > [Control Panel].
- 2** Double-click [Network].
- 3** Right-click on [Local Area Connection], then click [Properties].
- 4** Select [Internet Protocol (TCP/IP)], then click [Properties].
- 5** To have DHCP set your IP address settings automatically, check [Obtain an IP address automatically] and [Obtain DNS server address automatically].

To set your IP address settings manually, enter values for each setting. Examples:

If your AirStation's IP address is 1.1.1.1,	
IP address	1.1.1.2
Subnet mask	255.255.255.0
Default gateway	blank
Preferred DNS server	blank
Alternate DNS server	blank

- 6** Click [Close].

TCP/IP Settings (Mac OS X)

To configure TCP/IP in Mac OS X, follow the procedure below.

- 1** Click [Apple menu] > [System Preferences...].
- 2** Click [Network].
- 3** Click [Ethernet].
- 4** To have DHCP set your IP address settings automatically, select [Using DHCP] in the Configure IPv4 field.

To set your IP address settings manually, select [Manually] in the Configure IPv4 field and enter values for each setting. Examples:

If your AirStation's IP address is 1.1.1.1,

IP Address	1.1.1.2
Subnet Mask	255.255.255.0
Router	blank
DNS Server	blank
Search Domains	blank

- 5** Click [Apply].

Other Tips

Issue:

I reset my AirStation to factory settings and forgot how to log in to the configuration interface.

Answer:

Open your browser, enter 1.1.1.1 as the browser address, and hit Enter. You will be prompted to log in. Enter "admin" for the username and "password" for the password. Click [OK] to log in. The option to reset your password will be available on the first page.

Issue:

What can I do if my wireless connection drops randomly or seems slow?

Answer:

There are many environmental factors that may cause this. First, ensure the issue is not range related by moving the wireless router and the client device closer together. If the connection drops continue, then range is probably not the issue.

Other 2.4 GHz devices such as microwaves, other wireless networks, and 2.4 GHz wireless phones may impact performance. Try a different wireless channel for your wireless router. Log in to the wireless router with your browser. Click on the Wireless Config tab and then the Basic tab. Wireless channels from 1 - 11 may be selected. Try the Auto-Channel option if available. Otherwise, manually select an alternate channel and click [Apply].

Issue:

Where can I download the latest drivers, firmware, and instructions for my Buffalo wireless products?

Answer:

The latest drivers and firmware are available online at **www.buffalotech.com**

Appendix

Specifications

Wired LAN Interface	
Standard Compliance	IEEE802.3ab (1000BASE-T), IEEE802.3u (100BASE-TX), IEEE802.3 (10BASE-T)
Transmission Rate	10 / 100 / 1000 Mbps
Transmission Encoding	1000 BASE-T 4DPAM5, 100 BASE-TX 4B5B/MLT-3, 10 BASE-T Manchester Coding
Access Method	CSMA/CD
Speed and Flow Control	10 / 100 / 1000 Mbps, Auto Sensing, Auto MDIX
Number of LAN Port	4
LAN Port Connector	RJ-45
Wireless LAN Interface	
Standard Compliance	IEEE802.11ac (Draft 2.0) /n/a/g/b
Transmission Method	Direct Sequence Spread Spectrum (DSSS), OFDM, MIMO
Transmission Rate 802.11ac (Draft)	802.11ac (Draft): 20 MHz BW (Long GI) 260, 234, 195, 175.5, 156, 117, 78, 58.5, 39, 19.5 Mbps (3 stream) 156, 130, 117, 104, 78, 52, 39, 26, 13 Mbps (2 stream) 78, 65, 58.5, 52, 39, 26, 19.5, 13, 6.5 Mbps (1 stream) 20 MHz BW (Short GI) 288.9, 260, 216.7, 195, 173.3, 130, 86.7, 65, 43.3, 21.7 Mbps (3 stream) 173.3, 144.4, 130, 115.6, 86.7, 57.8, 43.3, 28.9, 14.4 Mbps (2 stream) 86.7, 72.2, 65, 57.8, 43.3, 28.9, 21.7, 14.4, 7.2 Mbps (1 stream) 40 MHz BW (Long GI) 540, 486, 405, 364.5, 324, 243, 162, 121.5, 81, 40.5 Mbps (3 stream) 360, 324, 270, 243, 216, 162, 108, 81, 54, 27 Mbps (2 stream) 180, 162, 135, 121.5, 108, 81, 54, 40.5, 27, 13.5 Mbps (1 stream) 40 MHz BW (Short GI) 600, 540, 450, 405, 360, 270, 180, 135, 90, 45 Mbps (3 stream) 400, 360, 300, 270, 240, 180, 120, 90, 60, 30 Mbps (2 stream) 200, 180, 150, 135, 120, 90, 60, 45, 30, 15 Mbps (1 stream) 80 MHz BW (Long GI) 1170, 1053, 877.5, 702, 526.5, 351, 263.3, 175.5, 87.8 Mbps (3 stream) 780, 702, 585, 526.5, 468, 351, 234, 175.5, 117, 58.5 Mbps (2 stream) 390, 351, 292.5, 263.3, 234, 175.5, 117, 87.8, 58.5, 29.3 Mbps (1 stream) 80 MHz BW (Short GI) 1300, 1170, 975, 780, 585, 390, 292.5, 195, 97.5 Mbps (3 stream) 866.7, 780, 650, 585, 520, 390, 260, 195, 130, 65 Mbps (2 stream) 433.3, 390, 325, 292.5, 260, 195, 130, 97.5, 65, 32.5 Mbps (1 stream)

Transmission Rate 802.11n/a/b/g	802.11n: 20 MHz BW (Long GI) 195, 175.5, 156, 117, 78, 58.5, 39, 19.5 Mbps (3 stream) 130, 117, 104, 78, 52, 39, 26, 13 Mbps (2 stream) 65, 58.5, 52, 39, 26, 19.5, 13, 6.5 Mbps (1 stream) 20 MHz BW (Short GI) 216.7, 195, 173.3, 130, 86.7, 65, 43.3, 21.7 Mbps (3 stream) 144.4, 130, 115.6, 86.7, 57.8, 43.3, 28.9, 14.4 Mbps (2 stream) 72.2, 65, 57.8, 43.3, 28.9, 21.7, 14.4, 7.2 Mbps (1 stream) 40 MHz BW (Long GI) 405, 364.5, 324, 243, 162, 121.5, 81, 40.5 Mbps (3 stream) 270, 243, 216, 162, 108, 81, 54, 27 Mbps (2 stream) 135, 121.5, 108, 81, 54, 40.5, 27, 13.5 Mbps (1 stream) 40 MHz BW (Short GI) 450, 405, 360, 270, 180, 135, 90, 45 Mbps (3 stream) 300, 270, 240, 180, 120, 90, 60, 30 Mbps (2 stream) 150, 135, 120, 90, 60, 45, 30, 15 Mbps (1 stream) 802.11a/g: 54, 48, 36, 24, 18, 12, 9, 6 Mbps 802.11b: 11, 5.5, 2, 1 Mbps
Frequency Range	Available frequencies depend on the country of purchase. See the next page for details.
Access Mode	Infrastructure Mode
Security	AOSS, WPS, WPA2-PSK (TKIP/AES), WPA-PSK (TKIP/AES), 128/64bit WEP
Other	
Power Supply	External AC 100 - 240 V Universal, 50/60 Hz
Power Consumption	About 9.8 W (Max)
Dimensions	212.2 x 183.2 x 34 mm (8.4 x 7.2 x 1.3 in.)
Weight	500 g (17.6 oz.)
Operating Environment	0 - 40° C (32 - 104° F) , 20 - 80 % (non-condensing)

802.11a Frequency Range

USA Canada	5180-5240 MHz (Channels 36, 40, 44, 48)
---------------	---

802.11g Frequency Range

USA Canada	2412-2462 MHz (Channels 1, 2, 3, 4, 5, 6, 7, 8, 9, 10, 11)
---------------	--

Default Configuration Settings

Feature	Parameter	Default Setting
LAN	LAN Side IP Address	Manual Setup 1.1.1.1 (255.255.255.0)
	Default Gateway	none
	DNS Server Address	none
WPS	WPS	Enabled
	List of wireless connections (WPS)	none
AOSS	Encryption Type	none
	AOSS Button on the AirStation Unit	Enabled
Basic	SSID	none
	Wireless Authentication	Do not authenticate
	Encryption for wireless	Not encrypted
	11A/11G selection	11a only
Advanced	MAC Address for wireless communication	Unit Address
	802.11n protection	Disabled
	Output Power	100%
	Request of multicast translation	Enabled

Feature	Parameter	Default Setting		
WMM	WMM-EDCA Parameters (Priority AC_BK (Low))		For AP	For STA
		CWmin	15	15
		CWmax	1023	1023
		AIFSN	7	7
		TXOP Limit	0	0
		Admission Control	-----	Disabled
	WMM-EDCA Parameters (Priority AC_BE (Normal))		For AP	For STA
		CWmin	15	15
		CWmax	63	1023
		AIFSN	3	3
		TXOP Limit	0	0
		Admission Control	-----	Disabled
	WMM-EDCA Parameters (Priority AC_VI (High))		For AP	For STA
		CWmin	7	7
		CWmax	15	15
		AIFSN	1	2
		TXOP Limit	94	94
		Admission Control	-----	Disabled
	WMM-EDCA Parameters (Priority AC_VO (Highest))		For AP	For STA
		CWmin	3	3
CWmax		7	7	
AIFSN		1	2	
TXOP Limit		47	47	
Admission Control		-----	Disabled	
Name	AirStation Name	AP + AirStation's MAC Address		
Password	Administrator Name	admin (fixed)		
	Administrator Password	password		
Time/Date	Local Date	2012 Year 1 Month 1 Day		
	Local Time	0 Hour 0 Minute 0 Seconds		
	Time Zone	(GMT-06:00) Central Standard Time: CST		
	DST (Daylight Saving Time)	USA (From Second Sunday in Mar to first Sunday in Nov)		
NTP	NTP Functionality	Enabled		
	NTP Server	time.nist.gov		
	Update Interval	24 hours		

Feature	Parameter	Default Setting
Access	Log Output	Disabled
	Limitation Item	Prohibit configuration from wireless LAN Disabled Prohibit configuration from wired LAN Disabled
Log	Log Transfer	Disabled
	Syslog Server	none
	Logs	IP Filter, DHCP Client, AOSS, Wireless, Authentication, Setting Changes, System Boot, NTP Client, Wired Link, and System
Update	Update Method	Specify Local File
	Firmware Update Reminder	Enabled
	Remind Time	Automatic

Ethernet Converter Manager

Ethernet Converter Manager Overview

Ethernet Converter Manager is a tool to manage your AirStation. It lets you change the AirStation's IP address. To install this software, insert the Air Navigator CD into your computer. On the setup screen, click [Software installation].

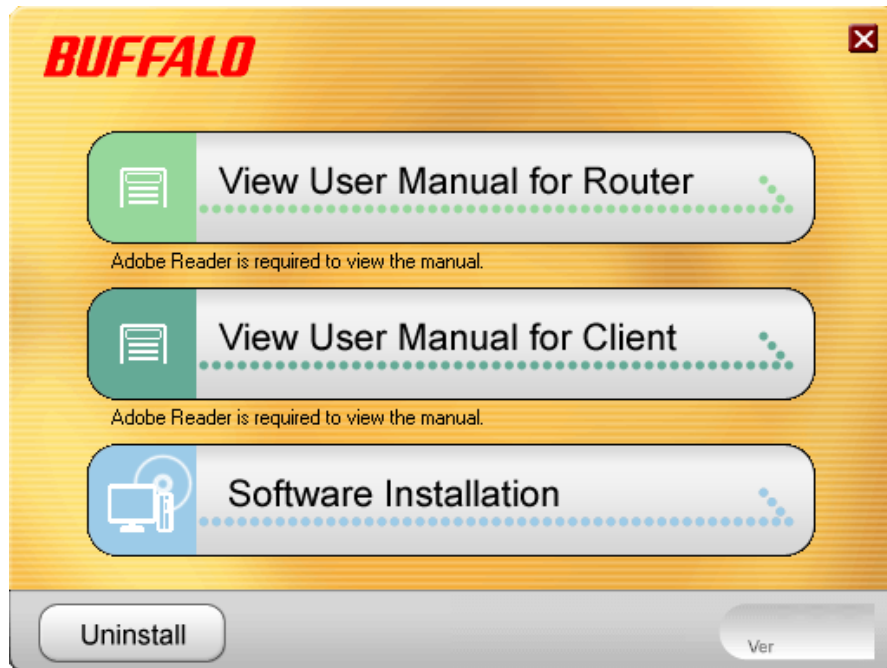

Opening and Closing Ethernet Converter Manager

To start Ethernet Converter Manager, click [Start] > [All programs] > [BUFFALO] > [AirStation Utility] > [Ethernet Converter Manager]. To close the Ethernet Converter Manager, click [X] at the top right of the screen, or click [Exit].

Select LAN Adapter screen

Select which LAN adapter will be used to set up the AirStation. This screen is displayed if your computer has more than one NIC or other LAN devices. Choose a LAN adapter that is connected to the same network as the AirStation.

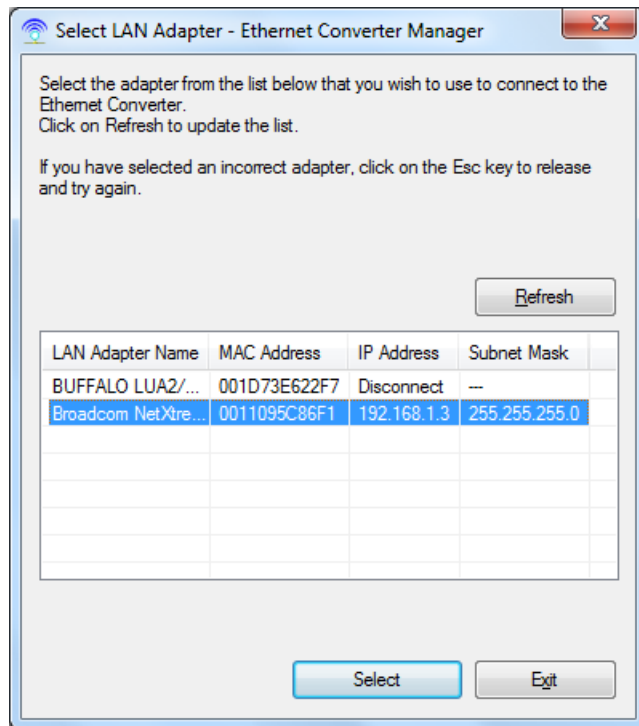

Parameter

Meaning

Refresh	Click this button to update the list.
Select	Highlight your LAN Adapter, then click this button to configure the AirStation.
Exit	Closes the Ethernet Converter Manager.

Select Ethernet Converter

If you have multiple AirStations on the network, they'll all be displayed here. Choose your AirStation from the list and highlight it. Click [Select].

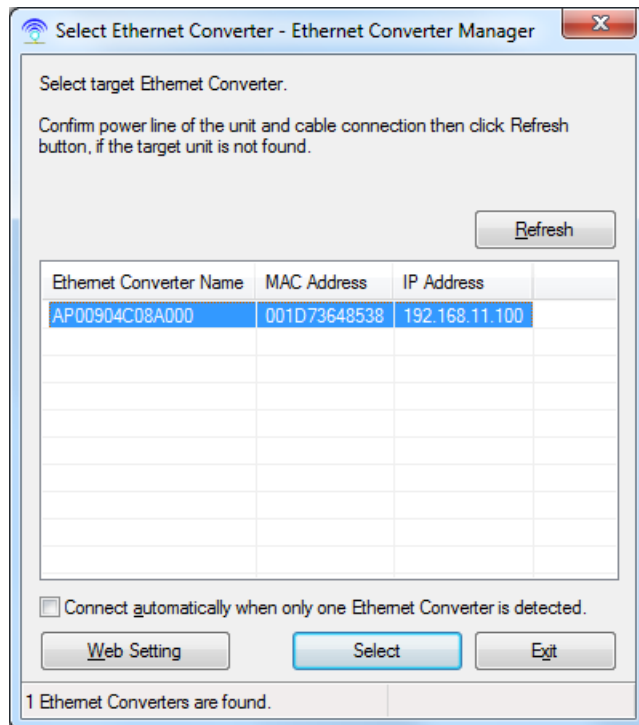

Parameter

Meaning

Refresh	Click this button to search and view the list of the AirStations that can be configured with this software.
Connect automatically when only one Ethernet Converter is detected	Check this option to skip this screen when there is only one AirStation that can be configured.
Web Setting	Click this button to display the AirStation's Web configuration interface. Note: If your computer and the AirStation are on different network subnets, then the IP address settings page will be displayed instead.
Select	Highlight your AirStation, then click this button to display the main screen.
Exit	Closes the Ethernet Converter Manager.

Main Screen

Change your AirStation's IP address or other settings from this window.

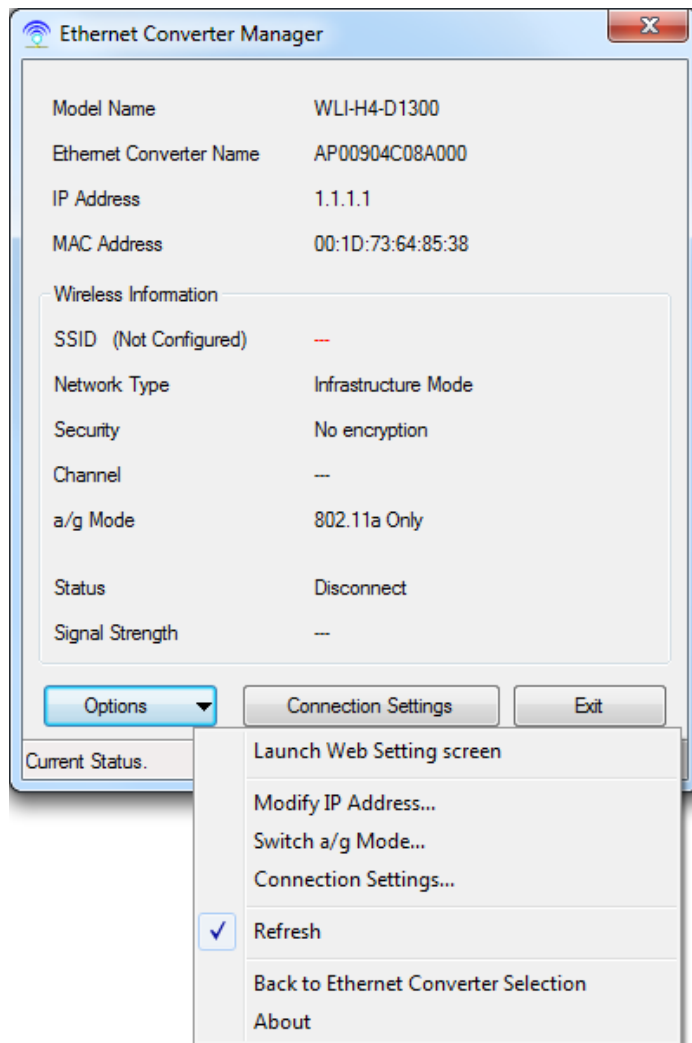

Parameter

Meaning

Options > Launch Web Setting screen	Displays the AirStation's Web configuration interface. Note: If your PC and the AirStation are on different network subnets, then the IP address configuration screen is displayed instead.
Options > Modify IP Address...	Displays the IP address configuration screen.
Options > Switch a/g Mode...	This is not supported feature for this product.
Options > Connection Settings...	Displays the connection settings for access points.
Options > Refresh	Updates displayed information for your AirStation.

Parameter	Meaning
Options > Back to Ethernet Converter Selection	Takes you back to the AirStation selection screen.
Options > About	Displays the version number of your Ethernet Converter Manager.
Connection Settings	Display the access point connection settings screen.
Exit	Close Ethernet Converter Manager.

Modify IP Address Screen

Modify the AirStation's IP address.

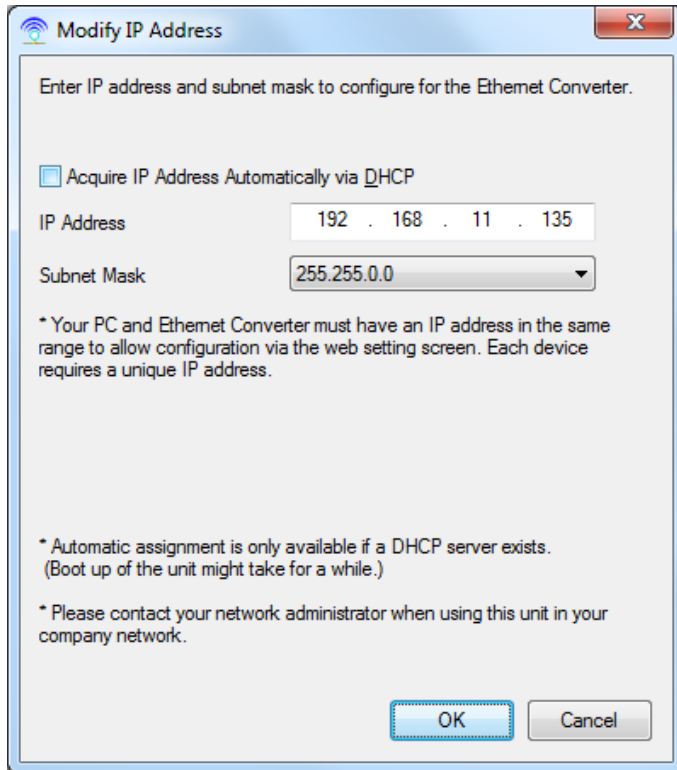

Parameter	Meaning
-----------	---------

Acquire IP Address Automatically via DHCP	Check this option to automatically obtain an IP address from a DHCP server.
IP Address / Subnet Mask	If DHCP is not enabled, you can enter an IP address and subnet mask for the AirStation manually.

Connection Settings

Configure your access point's wireless connection settings.

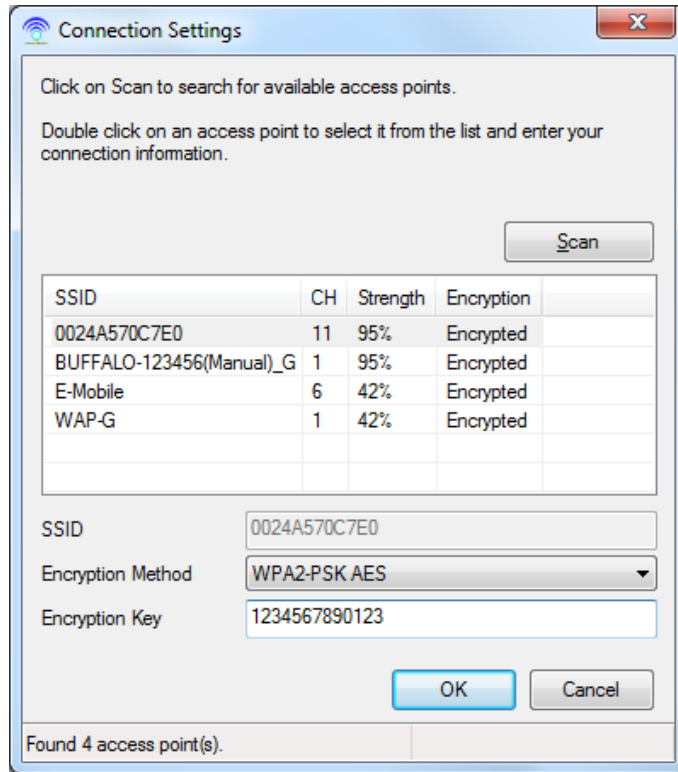

Parameter

Meaning

Scan	Click this button to search for available access points.
SSID	Select an access point to connect to. Double-click on an access point's SSID to select it.
Encryption method	Select the type of encryption to use.
Encryption Key	Enter the AP's encryption key.

Regulatory Compliance Information

Federal Communication Commission Interference Statement

This equipment has been tested and found to comply with the limits for a Class B digital device, pursuant to Part 15 of the FCC Rules. These limits are designed to provide reasonable protection against harmful interference in a residential installation. This equipment generates, uses and can radiate radio frequency energy and, if not installed and used in accordance with the instructions, may cause harmful interference to radio communications. However, there is no guarantee that interference will not occur in a particular installation. If this equipment does cause harmful interference to radio or television reception, which can be determined by turning the equipment off and on, the user is encouraged to try to correct the interference by one of the following measures:

- Reorient or relocate the receiving antenna.
- Increase the separation between the equipment and receiver.
- Connect the equipment into an outlet on a circuit different from that to which the receiver is connected.
- Consult the dealer or an experienced radio/TV technician for help.

FCC Caution:

Any changes or modifications not expressly approved by the party responsible for compliance could void the user's authority to operate this equipment.

This device complies with Part 15 of the FCC Rules. Operation is subject to the following two conditions: (1) This device may not cause harmful interference, and (2) this device must accept any interference received, including interference that may cause undesired operation.

For product available in the USA/Canada market, only channel 1~11 can be operated. Selection of other channels is not possible. This device is going to be operated in 5.15~5.25GHz frequency range, it is restricted in indoor environment only.

Important Note - FCC Radiation Exposure Statement:

This equipment complies with FCC radiation exposure limits set forth for an uncontrolled environment. This device and its antenna(s) must not be co-located or operation in conjunction with any other antenna or transmitter. This equipment should be installed and operated with minimum distance 20cm between the radiator & your body.

This transmitter must not be co-located or operating in conjunction with any other antenna or transmitter.

The availability of some specific channels and/or operational frequency bands are country dependent and are firmware programmed at the factory to match the intended destination. The firmware setting is not accessible by the end user.

Industry Canada statement: Industrie Canada déclaration:

This Class B digital apparatus complies with Canadian ICES-003.

This device complies with RSS-210 of the Industry Canada Rules. Operation is subject to the following two conditions:

- (1) This device may not cause harmful interference, and
- (2) this device must accept any interference received, including interference that may cause undesired operation.

Cet appareil numérique de la classe B est conforme à la norme NMB-003 du Canada.

Ce dispositif est conforme à la norme CNR-210 d'Industrie Canada applicable aux appareils radio exempts de licence. Son fonctionnement est sujet aux deux conditions suivantes:

- (1) le dispositif ne doit pas produire de brouillage préjudiciable, et
- (2) ce dispositif doit accepter tout brouillage reçu, y compris un brouillage susceptible de provoquer un fonctionnement indésirable.

Caution:

Prudence:

The device for the band 5150-5250 MHz is only for indoor usage to reduce potential for harmful interference to co-channel mobile satellite systems.

Le dispositif fonctionnant dans la bande 5150-5250 MHz est réservé uniquement pour une utilisation à l'intérieur afin de réduire les risques de brouillage préjudiciable aux systèmes de satellites mobiles utilisant les mêmes canaux.

For product available in the USA/Canada market, only channel 1~11 can be operated. Selection of other channels is not possible.

The device could automatically discontinue transmission in case of absence of information to transmit, or operational failure. Note that this is not intended to prohibit transmission of control or signaling information or the use of repetitive codes where required by the technology.

Important Note - Radiation Exposure Statement: Note Importante - Déclaration d'exposition aux radiations:

This equipment complies with IC RSS-102 radiation exposure limits set forth for an uncontrolled environment. This equipment should be installed and operated with minimum distance 20 cm between the radiator & your body.

Cet équipement respecte les limites d'exposition aux rayonnements IC RSS-102 définies pour un environnement non contrôlé. Il doit être installé et utilisé en maintenant une distance minimum de 20 cm entre le radiateur et votre corps.

Europe – EU Declaration of Conformity

This device complies with the essential requirements of the R&TTE Directive 1999/5/EC. The following test methods have been applied in order to prove presumption of conformity with the essential requirements of the R&TTE Directive 1999/5/EC:

EN60950-1: 2006+A11:2009

Safety of Information Technology Equipment

EN 62311: 2008

Assessment of electronic and electrical equipment related to human exposure restrictions for electromagnetic fields (0 Hz – 300 GHz)

EN 300 328 V1.7.1 (2006-10)

Electromagnetic compatibility and Radio spectrum Matters (ERM); Wideband transmission systems; Data transmission equipment operating in the 2,4 GHz ISM band and using wide band modulation techniques; Harmonized EN covering essential requirements under article 3.2 of the R&TTE Directive

EN 301 489-1 V1.8.1 (2008-04)

Electromagnetic compatibility and Radio Spectrum Matters (ERM); ElectroMagnetic Compatibility (EMC) standard for radio equipment and services; Part 1: Common technical requirements

EN 301 489-17 V2.1.1 (2009-05)

Electromagnetic compatibility and Radio spectrum Matters (ERM); ElectroMagnetic Compatibility (EMC) standard for radio equipment and services; Part 17: Specific conditions for 2,4 GHz wideband transmission systems and 5 GHz high performance RLAN equipment.

EN 301 893 V1.5.1: 2008

Broadband Radio Access Networks (BRAN); 5 GHz high performance RLAN; Harmonized EN covering essential requirements of article 3.2 of the R&TTE Directive

This device is a 2.4 GHz wideband transmission system (transceiver), intended for use in all EU member states and EFTA countries, except in France and Italy where restrictive use applies.

In Italy the end-user should apply for a license at the national spectrum authorities in order to obtain authorization to use the device for setting up outdoor radio links and/or for supplying public access to telecommunications and/or network services.

This device may not be used for setting up outdoor radio links in France and in some areas the RF output power may be limited to 10 mW EIRP in the frequency range of 2454 – 2483.5 MHz. For detailed information the end-user should contact the national spectrum authority in France.

CE0700 

Česky [Czech]

Buffalo Technology Inc. tímto prohlašuje, že tento AirStation WLI-H4-D1300 je ve shodě se základními požadavky a dalšími příslušnými ustanoveními směrnice 1999/5/ES.

Dansk [Danish]

Undertegnede Buffalo Technology Inc. erklærer herved, at følgende udstyr AirStation WLI-H4-D1300 overholder de væsentlige krav og øvrige relevante krav i direktiv 1999/5/EF.

Deutsch [German]

Hiermit erklärt Buffalo Technology Inc. dass sich das Gerät AirStation WLI-H4-D1300 in Übereinstimmung mit den grundlegenden Anforderungen und den übrigen einschlägigen Bestimmungen der Richtlinie 1999/5/EG befindet.

Eesti [Estonian]

Käesolevaga kinnitab Buffalo Technology Inc. seadme AirStation WLI-H4-D1300 vastavust direktiivi 1999/5/EÜ põhinõuetele ja nimetatud direktiivist tulenevatele teistele asjakohastele sätetele.

English

Hereby, Buffalo Technology Inc. declares that this AirStation WLI-H4-D1300 is in compliance with the essential requirements and other relevant provisions of Directive 1999/5/EC.

Español [Spanish]

Por medio de la presente Buffalo Technology Inc. declara que el AirStation WLI-H4-D1300 cumple con los requisitos esenciales y cualesquiera otras disposiciones aplicables o exigibles de la Directiva 1999/5/CE.

Ελληνική [Greek]

ΜΕ ΤΗΝ ΠΑΡΟΥΣΑ Buffalo Technology Inc. ΔΗΛΩΝΕΙ ΟΤΙ AirStation WLI-H4-D1300 ΣΥΜΜΟΡΦΩΝΕΤΑΙ ΠΡΟΣ ΤΙΣ ΟΥΣΙΩΔΕΙΣ ΑΠΑΙΤΗΣΕΙΣ ΚΑΙ ΤΙΣ ΛΟΙΠΕΣ ΣΧΕΤΙΚΕΣ ΔΙΑΤΑΞΕΙΣ ΤΗΣ ΟΔΗΓΙΑΣ 1999/5/EK.

Français [French]

Par la présente Buffalo Technology Inc. déclare que l'appareil AirStation WLI-H4-D1300 est conforme aux exigences essentielles et aux autres dispositions pertinentes de la directive 1999/5/CE.

Italiano [Italian]

Con la presente Buffalo Technology Inc. dichiara che questo AirStation WLI-H4-D1300 è conforme ai requisiti essenziali ed alle altre disposizioni pertinenti stabilite dalla direttiva 1999/5/CE.

Latviski [Latvian]

Ar šo Buffalo Technology Inc. deklarē, ka AirStation WLI-H4-D1300 atbilst Direktīvas 1999/5/EK būtiskajām prasībām un citiem ar to saistītajiem noteikumiem.

Lietuvių [Lithuanian]

Šiuo Buffalo Technology Inc. deklaruoja, kad šis AirStation WLI-H4-D1300 atitinka esminius reikalavimus ir kitas 1999/5/EB Direktyvos nuostatas.

Nederlands [Dutch]

Hierbij verklaart Buffalo Technology Inc. dat het toestel AirStation WLI-H4-D1300 in overeenstemming is met de essentiële eisen en de andere relevante bepalingen van richtlijn 1999/5/EG.

Malti [Maltese]

Hawnhekk, Buffalo Technology Inc. jiddikjara li dan AirStation WLI-H4-D1300 jikkonforma mal-ħtiġijiet essenzjali u ma provvedimenti oħrajn rilevanti li hemm fid-Dirrettiva 1999/5/EC.

Magyar [Hungarian]

Alulírott, Buffalo Technology Inc. hogy a WLI-H4-D1300 megfelel a vonatkozó alapvető követelményeknek és az 1999/5/EC irányelv egyéb előírásainak.

Polski [Polish]

Niniejszym Buffalo Technology Inc. oświadcza, że WLI-H4-D1300 jest zgodny z zasadniczymi wymogami oraz pozostałymi stosownymi postanowieniami Dyrektywy 1999/5/EC.

Português [Portuguese]

Buffalo Technology Inc. declara que este WLI-H4-D1300 está conforme com os requisitos essenciais e outras disposições da Directiva 1999/5/CE.

Slovensko [Slovenian]

Buffalo Technology Inc. izjavlja, da je ta WLI-H4-D1300 v skladu z bistvenimi zahtevami in ostalimi relevantnimi določili direktive 1999/5/ES.

Slovensky [Slovak]

Buffalo Technology Inc. týmto vyhlasuje, že WLI-H4-D1300 spĺňa základné požiadavky a všetky príslušné ustanovenia Smernice 1999/5/ES.

Suomi [Finnish]

Buffalo Technology Inc. vakuuttaa täten että WLI-H4-D1300 tyyppinen laite on direktiivin 1999/5/EY oleellisten vaatimusten ja sitä koskevien direktiivin muiden ehtojen mukainen.

Svenska [Swedish]

Härmed intygar Buffalo Technology Inc. att denna WLI-H4-D1300 står i överensstämmelse med de väsentliga egenskapskrav och övriga relevanta bestämmelser som framgår av direktiv 1999/5/EG.

Taiwan:

SAR compliance has been established in typical laptop computer(s) with USB slot, and product could be used in typical laptop computer with USB slot. Other application like handheld PC or similar device has not been verified and may not comply with related RF exposure rules and such use shall be prohibited.

Safety

This equipment is designed with the utmost care for the safety of those who install and use it. However, special attention must be paid to the dangers of electric shock and static electricity when working with electrical equipment. All guidelines of this manual and of the computer manufacturer must therefore be allowed at all times to ensure the safe use of the equipment.

根據 NCC 低功率電波輻射性電機管制辦法：

第十二條：

經型式認證合格之低功率射頻電機，非經許可，公司、商號或使用者均不得擅自變更頻率、加大功率或變更原設計之特性及功能。

第十四條：

低功率射頻電機之使用不得影響飛航安全及干擾合法通信；經發現有干擾現象時，應立即停用，並改善至無干擾時方得繼續使用。前項合法通信，指依電信法規定作業之無線電通信。低功率射頻電機須忍受合法通信或工業、科學及醫療用電波輻射性電機設備之干擾。

在5.25-5.35GHz頻帶內操作之無線資訊傳輸設備，限於室內使用。

기종별	사 용 자 안 내 문
B 급 기기 (가정용 정보통신기기)	이 기기는 가정용 (B 급) 전자파적합기기로서 주로 가정에서 사용하는 것을 목적으로 하며, 모든 지역에서 사용할 수 있습니다 .

Environmental Information

- The equipment that you have purchased has required the extraction and use of natural resources for its production.
- The equipment may contain hazardous substances that could impact health and the environment.
- In order to avoid the dissemination of those substances in our environment and to diminish the pressure on the natural resources, we encourage you to use the appropriate take-back systems.
- The take-back systems will reuse or recycle most of the materials of your end life equipment in a sound way.
- The crossed-out wheeled bin symbol invites you to use those systems.



- If you need more information on the collection, reuse and recycling systems, please contact your local or regional waste administration.

GPL Information

The source code for Buffalo products that use GPL code is available at <http://opensource.buffalo.jp/>.