



Baicells EG7035E User Manual

V100R001C00



About This Document

This document introduces the specifications of Baicells EG7035E CPE and guides users to install and configure it.

Copyright Notice

Baicells copyrights this specification. No part of this specification may be reproduced in any form or means, without the prior written consent of Baicells.

Disclaimer

This specification is preliminary and is subject to change at any time without notice. Baicells assumes no responsibility for any errors contained herein. For more information, please consult our technical engineers.

Revision Record

Date	Version	Description
24 Jan,2017	V1.0	Initial released.

Contact Us

Baicells Technologies Co., Ltd.North America

Address: 555 Republic Drive, Suite 200 Plano, TX 75074

E-mail: support_na@baicells.com

Phone: +1-972-800-1157

Website: <http://www.baicells.com/>

Contents

1.	Product Overview	1
1.1	Introduction	1
1.2	Features	1
1.3	Appearance	1
2.	Technical Specifications	5
2.1	Basic Specification	5
2.2	RF Specification	5
2.3	SW Specification	6
2.4	Device Management	6
2.5	Environment Specification	7
3.	Installation Guide.....	8
3.1	Support Materials.....	8
3.2	Install USIM Card and Ethernet Cable.....	8
3.3	Install on Pole	9
3.4	Install on Wall.....	10
3.5	Grounding.....	10
3.6	Regulatory Compliance	11
4.	Configuration Guide	13
4.1	Log in	13
4.2	View Status.....	13
4.3	Basic Configuration	14
4.3.1	LTE Setting	14
4.3.2	Set Connection Method.....	14
4.3.3	Set Scan Mode	15
4.3.4	Lock Frequency (Earfcn)	15
4.3.5	Lock PCI.....	16
Appendix A	FAQs.....	18

Appendix B Shipping List..... 19

Figures

Figure 1-1 EG7035E Appearance	2
Figure 1-2 Interface and Button of EG7035E.....	2
Figure 1-3 LED Indicators of EG7035E.....	3
Figure 3-1 Install Ethernet Cable and USIM Card	8
Figure 3-2 Connection Diagram	9
Figure 3-3 Install the Bracket	9
Figure 3-4 Install on Pole	10
Figure 3-5 Install on Wall.....	10
Figure 3-6 Grounding	11
Figure 4-1 Login Page	13
Figure 4-2 View Status	14
Figure 4-3 Set Connection Method	14
Figure 4-4 Set Scan Mode	15
Figure 4-5 Lock Frequency	16
Figure 4-6 Lock Frequency	17

Tables

Table 1-1 Description of EG7035E Interface and Button	2
Table 1-2 LED Indicator Description.....	3
Table 2-1 Basic Specification	5
Table 2-2 RF Specification	5
Table 2-3 SW Specification	6
Table 2-4 Device Management.....	6
Table 2-5 Environment Specification.....	7
Table 3-1 Support Materials for Installing.....	8

1. Product Overview

1.1 Introduction

Baicells is a high-tech company dedicated in wireless broadband access solutions and service operation. With the advent of the Internet+ era, the development of WBB is imminent. Through continuous innovation, Baicells launches the world first mobile broadband system based on the Internet architecture and unlicensed spectrum. Baicells can provide series CPEs, include indoor and outdoor unit on different spectrums.

Baicells EG7035E is a high performance outdoor CPE. The EG7035E has the superior wireless access performance and comprehensive routing capabilities, which have the abilities to bring the end-users WBB services.

1.2 Features

The EG7035E is designed according to the simplicity principle, which can evolve in a short period and realize fast customization, delivery and deployment as well. The main features of the EG7035E is as follows:

- Support TD-LTE network according to the operator's choice.
- LTE TDD 3650MHz ~ 3700MHz
- Support the 100Mbps Ethernet interface.
- Intuitionist and convenient Web-based management.
- Built-in LTE bipolar directional high gain antenna.
- Support TR069 and OMA-DM network management protocol.
- Support cell lock, SIM lock, and Pin lock.
- User-friendly design of LED indicator.
- Power supply with PoE.
- Support pole installation or wall mounting.

1.3 Appearance

The EG7035E appearance is shown in Figure 1-1.

Figure 1-1 EG7035E Appearance



The EG7035E interfaces and buttons are shown in Figure 1-2.

Figure 1-2 Interface and Button of EG7035E

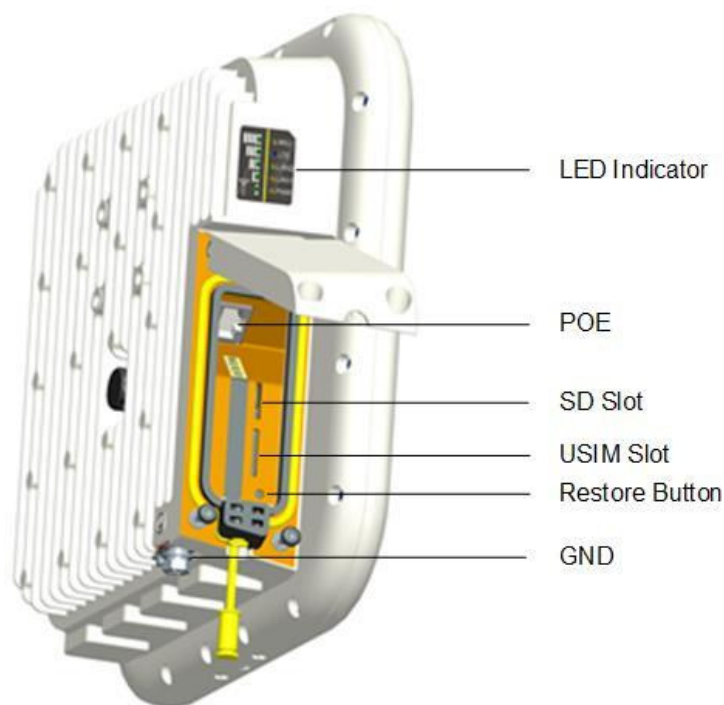

The EG7035E interface and button description is given in Table 1-1.

Table 1-1 Description of EG7035E Interface and Button

Interface & Button	Description
PoE	Connected to the PoE power adapter
SD slot	Support SD card
USIM Slot	Support 1.8V/3.0V USIM 2FF
Restore Button	Long press over 10 seconds to restore the factory settings

Interface & Button	Description
LED Indicator	LTE signal strength Indicator& status indicator
GND	Connected to Earth by conductor

The LED indicators are shown in Figure 1-3.

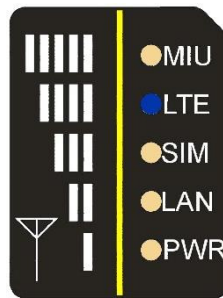

Figure 1-3 LED Indicators of EG7035E



The description of LED indicators are given in Table 1-2.

Table 1-2 LED Indicator Description

Identity	Description	Color	Status	Description
MIU	-	Yellow	OFF	Reserved.
			Steady On	Reserved.
			Blanking	Reserved.
LTE	Network state Indicator	Blue	OFF	LTE disconnected.
			Steady On	LTE connected.
SIM	SIM card status indicator	Yellow	Steady On	The SIM card is normal.
			Blanking	The SIM card is abnormal or not inserted.
LAN	100Mbps Eth Indication	Yellow	OFF	Ethernet connection does not established.
			Steady On	Ethernet connection is normal.
			Blanking	Data is transmitting.
PWR	Power Indicator	Yellow	OFF	No Power Supply
			Steady On	Power On

Identity	Description	Color	Status	Description	
LTE Signal	5 LTEs, Indicate connection state and signal strength	Green	All OFF	Signal is too weak to attach.	
			Steady On	According to signal strength in turn light up	
			Blanking		Scanning the LTE network
					The CPE is authenticating.
					CPE is getting IP address from the LTE network.

2. Technical Specifications

2.1 Basic Specification

Table 2-1 Basic Specification

Item	Description
LTE Standard	3GPP Release 9
Ethernet LAN Port	One RJ-45 port 10/100 auto-sensing, auto-MDX, PoE
LED Indicators	Power/LET Signal/LAN Indicator
USIM	Support 1.8V/3V 2FF
Restore Button	Tact Button Long press over 10s to restore the factory settings
Power Supply	Input: Universal range 100V~240V AC
Dimension	About 248mm * 248mm * 80mm
Weight	About 1800g
Color	Pantone white C

2.2 RF Specification

Table 2-2 RF Specification

Item	Description
Mode	TDD LTE
Channel Bandwidth	5 MHz /10 MHz /15 MHz /20 MHz
MAX Output Power	17dBm
LTE Standard	3GPP R9
Frequency	3650MHz~3700MHz
Antenna Gain	19.5 dBi
Mode	Wi-Fi
Frequency	2400MHz~2483.5MHz
MAX Output Power	15dBm
Antenna Gain	2dBi

2.3 SW Specification

Table 2-3 SW Specification

Item	Description
Language Settings	English
Network Mode	Bridge / NAT
SIM	<ul style="list-style-type: none"> PIN Management SIM Lock
Network Connection setup	<ul style="list-style-type: none"> Create, delete, and edit APNs Set up dial-up connection automatically Set up dial-up connection manual
LTE Scan Mode	<ul style="list-style-type: none"> Full Band Cell Lock Band / Frequency Preferred
VPN	<ul style="list-style-type: none"> Support VPN pass through Support PPTP tunnel mode
NAT	<ul style="list-style-type: none"> Port forwarding Port trigger DMZ UPnP
Statistics	<ul style="list-style-type: none"> LAN Link Status Transmit / Receive traffic Running Time

2.4 Device Management

Table 2-4 Device Management

Item	Description
Maintenance	<ul style="list-style-type: none"> Date & Time setting Reset Restore factory settings Restore/Backup Configuration File Local upgrade FOTA upgrade
TR069	Can enable or disable TR069 Management
Port mirror	Can enable or disable the port mirror function
Syslog	Support the syslog function can send the log to the PC via LAN
Diagnostics	Support the Ping and trace route

2.5 Environment Specification

Table 2-5 Environment Specification

Item	Description
Operating Temperature	-40°C ~ 55°C
Storage Temperature	-40°C ~ 70°C
Operating Humidity	5% ~ 95%

3. Installation Guide

3.1 Support Materials

Before installation, prepare the following support materials accordingly, as given in Table 3-1.

Table 3-1 Support Materials for Installing

Item	Description
Ethernet cable	Outdoor Shield CAT5E Shorter than 330 feet
Ground wire	16mm ² yellow-green wire

3.2 Install USIM Card and Ethernet Cable

1. Screw the two screws on the waterproof cover.
2. Open the waterproof cover, and connect the Ethernet cable to the Ethernet interface.
3. Insert the USIM card to the USIM slot. Note following the directions.
4. Close the waterproof cover and tighten the two screws on the cover, as shown in Figure 3-1.

Figure 3-1 Install Ethernet Cable and USIM Card

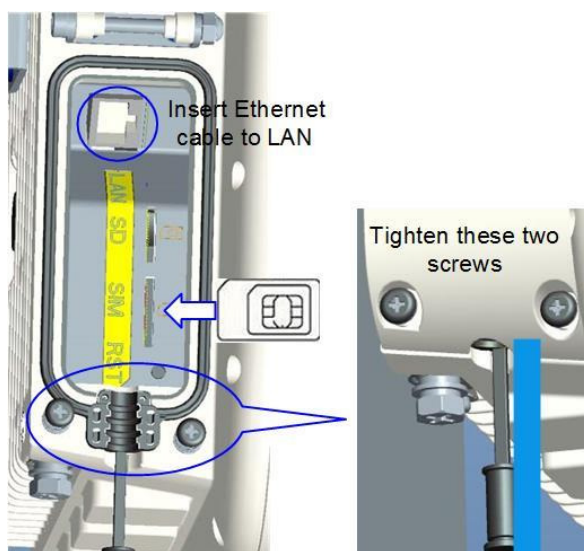

5. Connected Ethernet cable to the power adapter, as shown Figure 3-2.
Pay attention to the power adapter interface directions.

Figure 3-2 Connection Diagram

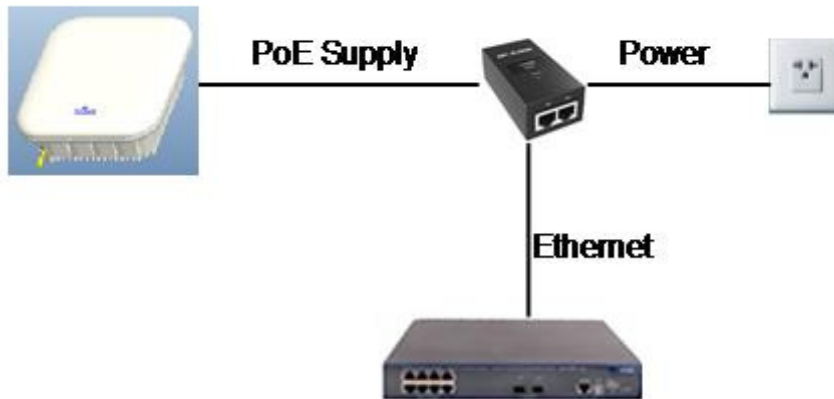

6. Power on, the LED indicator will light up.

3.3 Install on Pole

1. Tighten the screws at the bottom of the bracket, as shown in Figure 3-3.

Figure 3-3 Install the Bracket

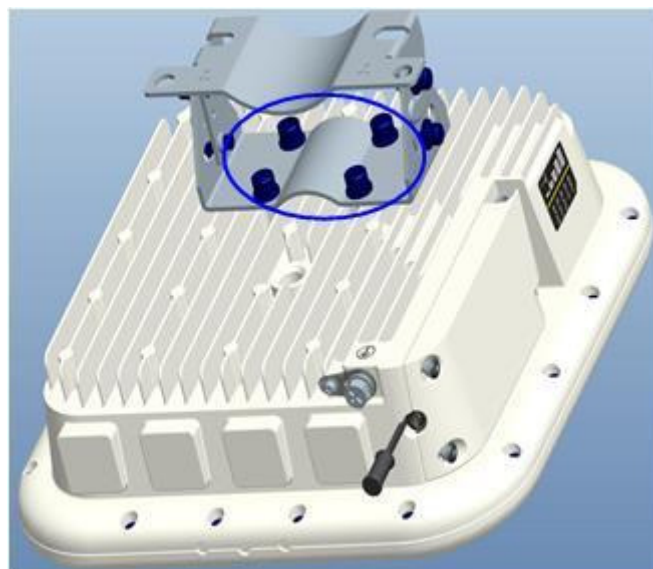

2. Install the bracket on pole as shown as Figure 3-4.

Figure 3-4 Install on Pole



3.4 Install on Wall

Install bracket on wall as show as Figure 3-5.

Figure 3-5 Install on Wall

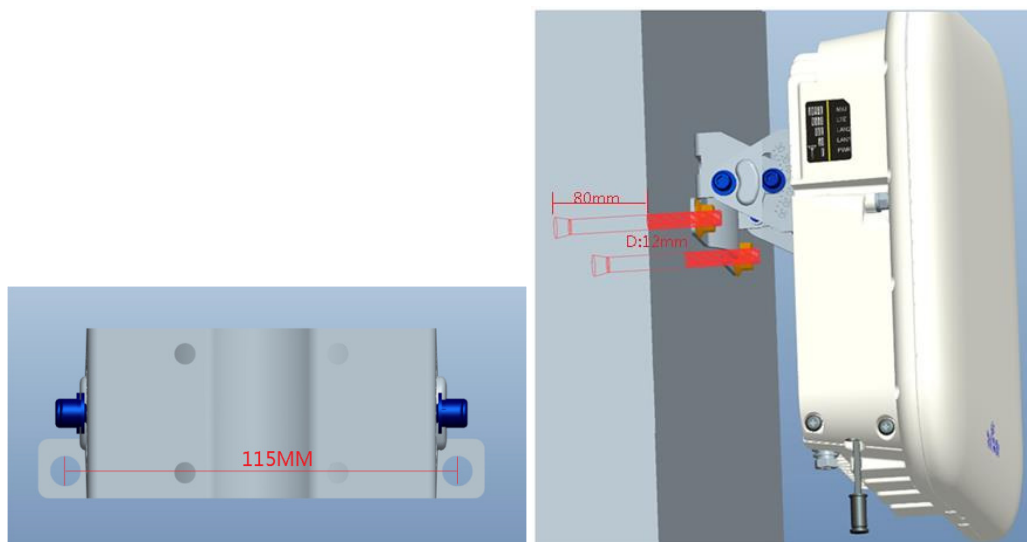

3.5 Grounding

The EG7035E must be grounding, please contact professional person to operation.

Using grounding cable, connect the grounding screw to the ground row, as shown in Figure 3-6.

Figure 3-6 Grounding

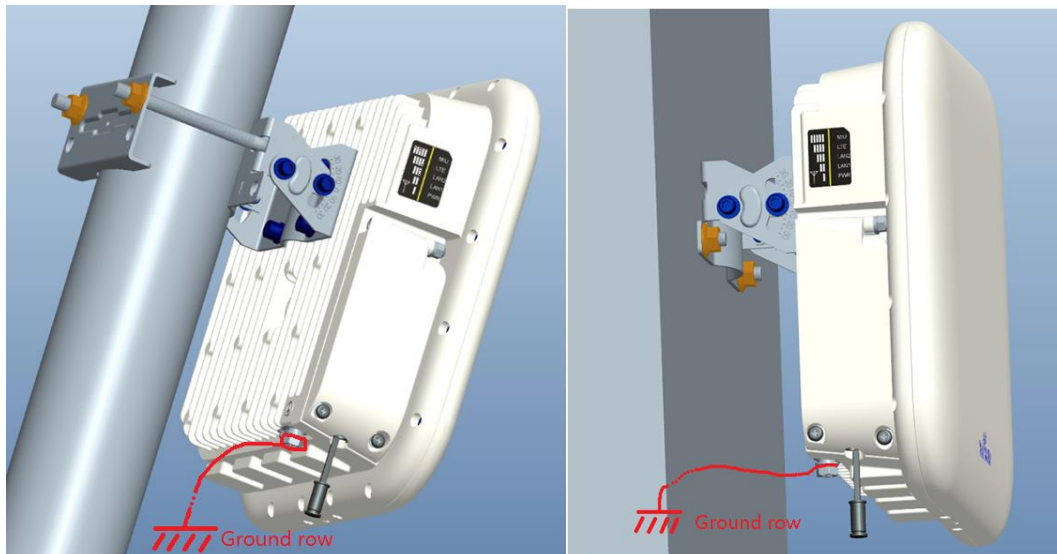

3.6 Regulatory Compliance

FCC Compliance

This device complies with part 15 of the FCC Rules. Operation is subject to the following two conditions: (1) This device may not cause harmful interference, and (2) this device must accept any interference received, including interference that may cause undesired operation.

Any Changes or modifications not expressly approved by the party responsible for compliance could void the user's authority to operate the equipment.

This equipment has been tested and found to comply with the limits for a Class A digital device, pursuant to part 15 of the FCC Rules. These limits are designed to provide reasonable protection against harmful interference when the equipment is operated in a commercial environment. This equipment generates, uses, and can radiate radio frequency energy and, if not installed and used in accordance with the instruction manual, may cause harmful interference to radio communications. Operation of this equipment in a residential area is likely to cause harmful interference in which case the user will be required to correct the interference at his own expense.

Warning

This equipment complies with FCC radiation exposure limits set forth for an

uncontrolled environment. This equipment should be installed and operated with minimum distance 30cm between the radiator & your body.

ISED Compliance

This device complies with Innovation, Science, and Economic Development Canada licence-exempt RSS standard(s).

Operation is subject to the following two conditions: (1) This device may not cause interference, and (2) This device must accept any interference, including interference that may cause undesired operation of the device.

Le présent appareil est conforme aux CNR d' Innovation, Science et Développement économique Canada applicables aux appareils radio exempts de licence.

L'exploitation est autorisée aux deux conditions suivantes:

- (1) l'appareil ne doit pas produire de brouillage, et
- (2) l'utilisateur de l'appareil doit accepter tout brouillage radioélectrique subi, même si le brouillage est susceptible d'en compromettre le fonctionnement.

The antenna(s) used for this transmitter must be installed to provide a separation distance of at least 30cm from all persons and must not be collocated or operating in conjunction with any other antenna or transmitter, End-Users must be provided with transmitter operation conditions for satisfying RF exposure compliance.

4. Configuration Guide

4.1 Log in

The EG7035E manages, configures, and maintains the device by web management page. The steps to log in are as follows:

1. In the address column of browser, type in **http://192.168.150.1**, then press “**Enter**”, login in page is shown in Figure 4-1.

Figure 4-1 Login Page

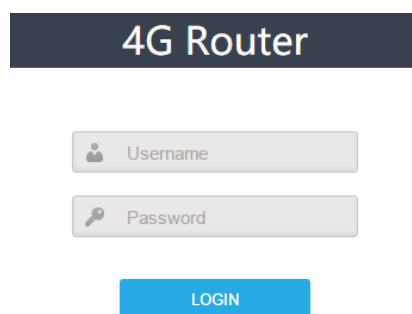

2. Enter the user name and password, click "**LOGIN**". After password authentication, you can log on to the web management page.

The default user name and password is admin.

For security, it is recommended that you open the firewall, and keep your login password, WLAN FTP passwords and password well.

4.2 View Status

In the overview area, you can view the device information and LTE status, such as Product name, Software version, PLMN, IMSI, RSRP, RSRQ, CINR, SINR, Tx Power, Cell ID, PCI, and so on, as shown in Figure 4-2.

Figure 4-2 View Status

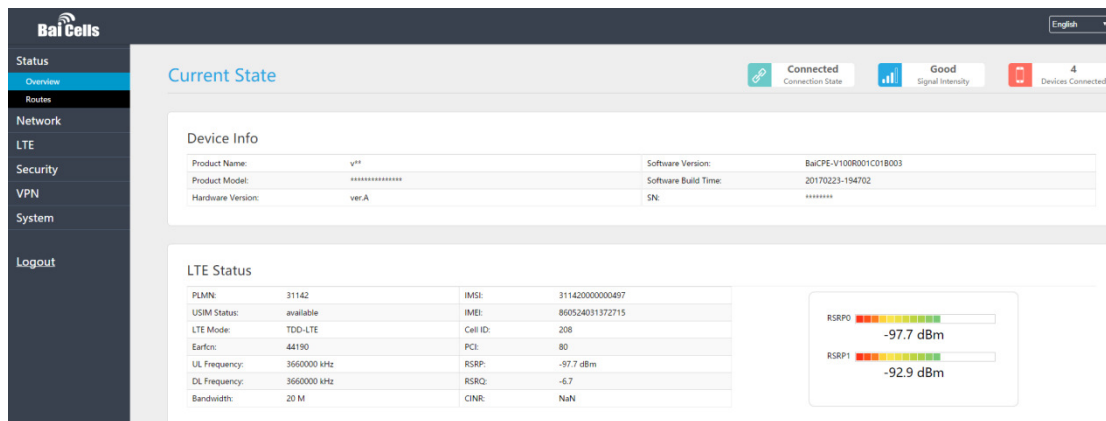

4.3 Basic Configuration

4.3.1 LTE Setting

To set the LTE Network, perform the following steps:

1. Choose **LTE**.
2. In the LTE Setting area, configure the LTE network.

4.3.2 Set Connection Method

To set the LTE network connection method, perform the following steps:

1. Choose "**LTE>connection Method**", enter the setting connection method page, as shown in Figure 4-3.

Figure 4-3 Set Connection Method

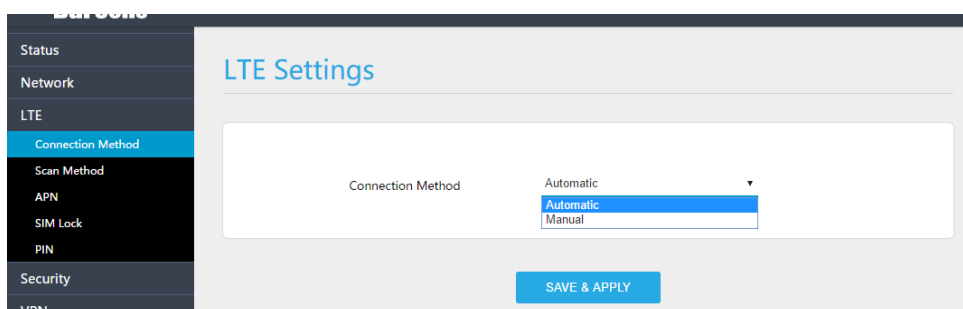

2. In the connection Method area, set the connection method
3. There are two methods to connect the LTE network, it is needed to choose a method between Auto and Manual, if you want to auto connect to the LET network you should choose the Auto, otherwise you should choose Manual.
4. Click **“SAVE & APPLY”**.

4.3.3 Set Scan Mode

To set the LTE network scan mode, perform the following steps:

1. Choose **“LTE>Scan Method”**, enter the setting scan method page, as shown in Figure 4-4.

Figure 4-4 Set Scan Mode

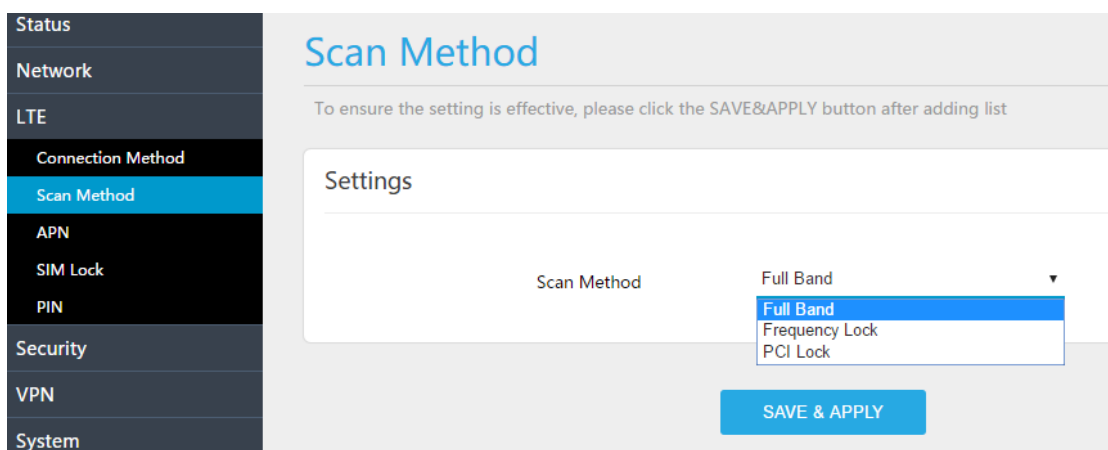

2. In the Scan Method area, set the scan mode
3. You can choose full Band, **Frequency Lock**, or **PCI Lock**.

4.3.4 Lock Frequency (Earfcn)

To clock the frequency, perform the following steps:

1. Choose **“LTE>Scan Method”**.
2. In the LTE Scan Method area, click Frequency Lock to lock the frequency.
3. Click **ADD LIST**, choose a band and frequency, and then click **Add** to add the band and frequency to the list, as shown in Figure 4-5.

Figure 4-5 Lock Frequency

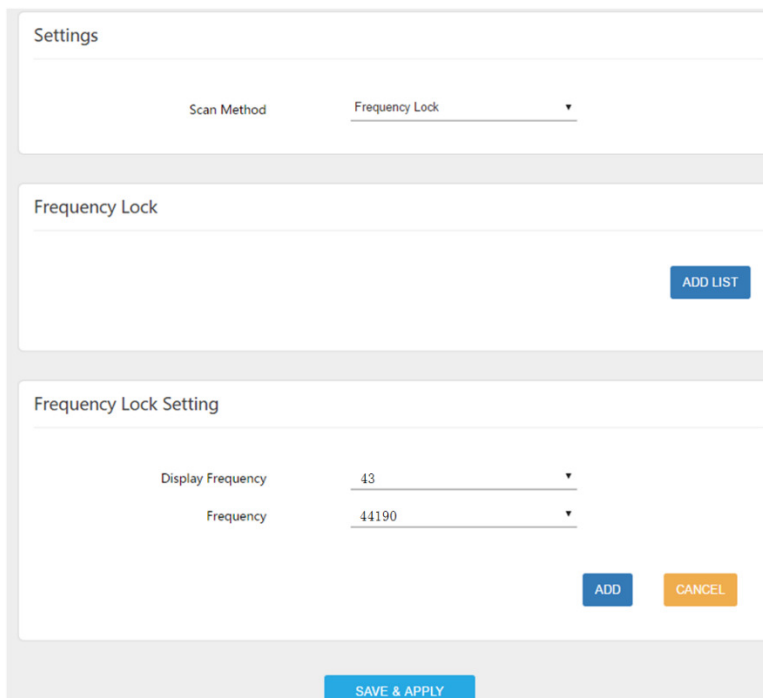

The screenshot shows a web-based configuration interface. At the top, there is a 'Settings' section with a dropdown menu for 'Scan Method' and another dropdown menu for 'Frequency Lock'. Below this is a 'Frequency Lock' section containing an empty list area and an 'ADD LIST' button. The bottom section is titled 'Frequency Lock Setting' and contains two dropdown menus: 'Display Frequency' with the value '43' and 'Frequency' with the value '44190'. There are 'ADD' and 'CANCEL' buttons to the right of these settings. At the very bottom of the interface is a 'SAVE & APPLY' button.

4. Click **“SAVE & APPLY”**.

4.3.5 Lock PCI

To lock the PCI, perform the following steps:

1. Choose **“LTE>Scan Method”**.
2. In the LTE Scan Method area, click PCI Lock to lock the PCI.
3. Click ADD LIST you can choose a band, frequency and PCI, then click Add to add the frequency and PCI to the list, as shown in Figure 4-6.

Figure 4-6 Lock Frequency

Scan Method

To ensure the setting is effective, please click the SAVE&APPLY button after adding list

Settings

Scan Method PCI Lock ▼

PCI Lock

ADD LIST

PCI Lock Setting

Display Frequency 43 ▼

Frequency 44190 ▼

PCI _____

ADD CANCEL

SAVE & APPLY

4. Click **“SAVE & APPLY”**.

Appendix A **FAQs**

The POWER indicator does not turn on.

- Make sure that the power cable is connected properly and the CPE is powered on.
- Make sure that the power adapter is compatible with the CPE.

Fails to Login to the web management page.

- Make sure that the CPE is started.
- Verify that the CPE is correctly connected to the computer through a network cable. If the problem persists, contact authorized local service suppliers.

The CPE fails to search for the wireless network.

- Check that the power adapter is connected properly.
- Check that the CPE is placed in an open area that is far away from obstructions, such as concrete or wooden walls.
- Check that the CPE is placed far away from household electrical appliances that generate strong electromagnetic field, such as microwave ovens, refrigerators, and satellite dishes.

If the problem persists, contact authorized local service suppliers.

The power adapter of the CPE is overheated.

- The CPE will be overheated after being used for a long time. Therefore, power off the CPE when you are not using it.
- Check that the CPE is properly ventilated and shielded from direct sunlight.





The parameters are restored to default values.

- If the CPE powers off unexpectedly while being configured, the parameters may be restored to the default settings.

After configuring the parameters, download the configuration file to quickly restore the CPE to the desired settings.

Appendix B Shipping List

The product outward appearance, the color take the material object as, the picture only supply reference.

Index	Content	Picture	Amount
1	EG7035E CPE		1
2	Power cord		1
3	PoE adapter		1
4	Mounting bracket		1
5	User Manual		1