

BALDOR
MOTORS AND DRIVES

MintDrive

Installation Manual

MN1274 06/2001



Copyright Baldor (c) 2001. All rights reserved.

This manual is copyrighted and all rights are reserved. This document or attached software may not, in whole or in part, be copied or reproduced in any form without the prior written consent of Baldor.

Baldor makes no representations or warranties with respect to the contents hereof and specifically disclaims any implied warranties of fitness for any particular purpose. The information in this document is subject to change without notice. Baldor assumes no responsibility for any errors that may appear in this document.

Mint™ is a registered trademark of Baldor.

Windows 95, Windows 98, Windows ME, Windows NT and Windows 2000 are registered trademarks of the Microsoft Corporation.

Limited Warranty

For a period of two (2) years from the date of original purchase, Baldor will repair or replace without charge controls and accessories which our examination proves to be defective in material or workmanship. This warranty is valid if the unit has not been tampered with by unauthorized persons, misused, abused, or improperly installed and has been used in accordance with the instructions and/or ratings supplied. This warranty is in lieu of any other warranty or guarantee expressed or implied. Baldor shall not be held responsible for any expense (including installation and removal), inconvenience, or consequential damage, including injury to any person or property caused by items of our manufacture or sale. (Some countries and U.S. states do not allow exclusion or limitation of incidental or consequential damages, so the above exclusion may not apply.) In any event, Baldor's total liability, under all circumstances, shall not exceed the full purchase price of the control. Claims for purchase price refunds, repairs, or replacements must be referred to Baldor with all pertinent data as to the defect, the date purchased, the task performed by the control, and the problem encountered. No liability is assumed for expendable items such as fuses. Goods may be returned only with written notification including a Baldor Return Authorization Number and any return shipments must be prepaid.

Baldor UK Ltd
Mint Motion Centre
6 Bristol Distribution Park
Hawley Drive
Bristol, BS32 0BF
Telephone: +44 (0) 1454 850000
Fax: +44 (0) 1454 850001
Email: technical.support@baldor.co.uk
Web site: www.baldor.co.uk

Baldor Electric Company
Telephone: +1 501 646 4711
Fax: +1 501 648 5792
Email: sales@baldor.com
Web site: www.baldor.com

Baldor ASR GmbH
Telephone: +49 (0) 89 90508-0
Fax: +49 (0) 89 90508-492

Baldor ASR AG
Telephone: +41 (0) 52 647 4700
Fax: +41 (0) 52 659 2394

Australian Baldor Pty Ltd
Telephone: +61 2 9674 5455
Fax: +61 2 9674 2495

Baldor Electric (F.E.) Pte Ltd
Telephone: +65 744 2572
Fax: +65 747 1708

Baldor Italia S.R.L
Telephone: +39 (0) 11 56 24 440
Fax: +39 (0) 11 56 25 660

Safety Notice

Only qualified personnel should attempt the start-up procedure or troubleshoot this equipment. This equipment may be connected to other machines that have rotating parts or parts that are controlled by this equipment. Improper use can cause serious or fatal injury. Only qualified personnel should attempt to start-up, program or troubleshoot this equipment.

Precautions

 **WARNING:** Do not touch any circuit board, power device or electrical connection before you first ensure that no high voltage is present at this equipment or other equipment to which it is connected. Electrical shock can cause serious or fatal injury. Only qualified personnel should attempt to start-up, program or troubleshoot this equipment.

 **WARNING:** Be sure the system is properly grounded before applying power. Do not apply AC power before you ensure that grounds are connected. Electrical shock can cause serious or fatal injury.

 **WARNING:** Be sure that you are completely familiar with the safe operation and programming of this equipment. This equipment may be connected to other machines that have rotating parts or parts that are controlled by this equipment. Improper use can cause serious or fatal injury. Only qualified personnel should attempt to program, start-up or troubleshoot this equipment.

 **WARNING:** Be sure all wiring complies with the National Electrical Code and all regional and local codes. Improper wiring may result in unsafe conditions.

 **WARNING:** The stop input to this equipment should not be used as the single means of achieving a safety critical stop. Drive disable, motor disconnect, motor brake and other means should be used as appropriate. Only qualified personnel should attempt to program, start-up or troubleshoot this equipment.















 **WARNING:** Improper operation or programming of the drive may cause violent motion of the motor shaft and driven equipment. Be certain that unexpected motor shaft movement will not cause injury to personnel or damage to equipment. Peak torque of several times the rated motor torque can occur during control failure.

 **WARNING:** The motor circuit might have high voltages present whenever AC power is applied, even when the motor is not rotating. Electrical shock can cause serious or fatal injury.

 **WARNING:** If a motor is driven mechanically, it might generate hazardous voltages that are conducted to its power terminals. The enclosure must be grounded to prevent possible shock hazard.

 **WARNING:** When operating a motor with no load coupled to its shaft, remove the shaft key to prevent it flying out when the shaft rotates.

 **WARNING:** A regeneration resistor may generate enough heat to ignite combustible materials. To avoid fire hazard, keep all combustible materials and flammable vapors away from the brake resistors.

-
-  **CAUTION:** To prevent equipment damage, be certain that the input power has correctly sized protective devices installed.
-  **CAUTION:** To prevent equipment damage, be certain that input and output signals are powered and referenced correctly.
-  **CAUTION:** To ensure reliable performance of this equipment be certain that all signals to/from the drive are shielded correctly.
-  **CAUTION:** Suitable for use on a circuit capable of delivering not more than the RMS symmetrical short circuit amperes listed here at rated voltage.
- | | |
|-------------------|--------------------------------|
| <u>Horsepower</u> | <u>RMS Symmetrical Amperes</u> |
| 1-50 | 5,000 |
-  **CAUTION:** Avoid locating the drive immediately above or beside heat generating equipment, or directly below water or steam pipes.
-  **CAUTION:** Avoid locating the drive in the vicinity of corrosive substances or vapors, metal particles and dust.
-  **CAUTION:** Do not connect AC power to the drive terminals U, V and W. Connecting AC power to these terminals may result in damage to the drive.
-  **CAUTION:** Baldor does not recommend using “Grounded Leg Delta” transformer power leads that may create ground loops and degrade system performance. Instead, we recommend using a four wire Wye.
-  **CAUTION:** Drives are intended to be connected to a permanent main power source, not a portable power source. Suitable fusing and circuit protection devices are required.
-  **CAUTION:** The safe integration of the drive into a machine system is the responsibility of the machine designer. Be sure to comply with the local safety requirements at the place where the machine is to be used. In Europe these are the Machinery Directive, the ElectroMagnetic Compatibility Directive and the Low Voltage Directive. In the United States this is the National Electrical code and local codes.
-  **CAUTION:** Drives must be installed inside an electrical cabinet that provides environmental control and protection. Installation information for the drive is provided in this manual. Motors and controlling devices that connect to the drive should have specifications compatible to the drive.
-  **CAUTION:** Violent jamming (stopping) of the motor shaft during operation may damage the motor and drive.
-  **CAUTION:** Do not tin (solder) exposed wires. Solder contracts over time and may cause loose connections. Use crimp connections where possible.
-  **CAUTION:** Electrical components can be damaged by static electricity. Use ESD (electro-static discharge) procedures when handling this drive.
-

 **CAUTION:** Ensure that resolver or encoder wires are properly connected. Incorrect installation may result in improper rotation or incorrect commutation.

 **CAUTION:** The threaded holes in the top and bottom of the enclosure are for cable clamps. Be sure to use a M4 bolt no longer than 12mm in length. Longer bolts might short circuit the electrical components inside the drive.

 **CAUTION:** Removing the cover will invalidate UL certification.

Contents

1	Introduction	1
1.1	MintDrive features	1
1.2	Receiving and inspection	2
1.2.1	Identifying the catalog number	2
1.3	MintDrive indicators	3
1.3.1	Monitor LED display	3
1.3.2	CAN 1 and 2 LEDs	3
1.3.3	Ready LED	3
1.3.4	DB On (Regeneration Load) LED	3
1.4	Units and abbreviations	4
2	Basic Installation	5
2.1	Outline	5
2.1.1	Hardware requirements	5
2.1.2	RS485 / RS422 systems	7
2.1.3	Power sources	7
2.1.4	Tools and miscellaneous hardware	7
2.1.5	Other information needed for installation	7
2.2	Mechanical installation and location requirements	8
2.2.1	Dimensions and mounting	9
2.3	Power connections	10
2.3.1	Grounding	11
2.3.2	Input power conditioning	12
2.3.3	Power disconnect and protection devices	12
2.3.4	Wire sizes	14
2.3.5	Single phase connection to package size A or B	15
2.3.6	Single phase connection to package size C	15
2.3.7	Three phase connection to package size C	16
2.3.8	24V control supply	16
2.3.9	DC Bus power connections from package size C	17
2.3.10	Power supply filters	18
2.4	Motor connections	19
2.4.1	Motor circuit contactors	20
2.4.2	Regeneration resistor (Dynamic Brake resistor)	21
2.5	Feedback connections	22
2.5.1	Resolver option	23
2.5.2	Encoder option	25
2.6	Drive enable	26

3	Input / Output	27
3.1	Outline	27
3.2	Analog I/O	27
3.2.1	Analog Input, Single Ended - X11	28
3.2.2	Analog Input, Differential - X11	29
3.2.3	Analog Inputs, Differential - X5	30
3.2.4	Analog Outputs, Bipolar - X11	32
3.2.5	Analog Outputs, Bipolar - X5	33
3.3	Digital I/O	34
3.3.1	Digital Inputs - X13	35
3.3.2	Digital Inputs - X5	37
3.3.3	Digital Outputs - X13	39
3.3.4	Digital Outputs - X5	40
3.4	Other I/O	41
3.4.1	Simulated encoder output - X3	41
3.4.2	Master (auxiliary) encoder input - X6	42
3.4.3	Serial port - X7	44
3.4.4	Using RS232 cable	45
3.4.5	Multidrop using RS485 / RS422 cable	46
3.4.6	Connecting Baldor HMI Operator Panels	47
3.4.7	Optional breakout board for connector X5	48
3.4.8	CAN peripherals	48
4	Tuning and Configuration	49
4.1	Outline	49
4.1.1	Connecting the MintDrive to the PC	49
4.1.2	Installing the software	49
4.1.3	Starting the MintDrive	50
4.2	Mint Configuration Tool Startup Wizard - coarse tuning	51
4.3	MCT Startup Wizard - fine-tuning	54
4.3.1	An introduction to closed loop control	54
4.3.2	Fine-tuning the speed loop	56
4.3.3	Fine-tuning the position loop	57
4.3.4	Jog test	59
4.3.5	Completing the Startup Wizard	60
4.4	MCT Wizard - hardware configuration	61
4.4.1	Digital input configuration	61
4.4.2	Digital output configuration	62
4.4.3	Axis0 parameter configuration	63
4.4.4	Axis0 error configuration	63
4.4.5	Axis0 tuning configuration	64
4.4.6	Miscellaneous configuration	64
4.4.7	Completing the configuration wizard	65

5	Mint WorkBench	67
5.1	Outline	67
5.1.1	Completing configuration	67
5.2	Using WorkBench	68
5.2.1	Selecting the controller	68
5.2.2	Menus and buttons	68
5.3	Watch window	70
5.3.1	Quick Watch tab	70
5.3.2	Speed Loop tab	71
5.3.3	Position Loop tab	72
5.3.4	Capture tab	73
5.4	Editor windows	74
5.4.1	Configuration window	74
5.4.2	Program window	74
5.4.3	Terminal window	75
5.4.4	Useful commands for testing	75
5.4.5	Firmware update	77
6	Specifications	79
6.1	Outline	79
6.1.1	General specifications	79
6.1.2	Power	80
6.1.3	Rectifier and regeneration	81
6.1.4	Resolver feedback	81
6.1.5	Encoder feedback	82
6.1.6	Control signals	82
6.1.7	Environmental	83
7	Troubleshooting	85
7.1	Outline	85
7.1.1	Problem diagnosis	85
7.1.2	Communication	86
7.1.3	Power up	87
7.1.4	Tuning	89
7.1.5	Mint gains	90
7.1.6	Ready LED is red	91
7.1.7	CAN	94

Appendices

A	Tuning	97
A.1	Introduction	97
A.1.1	Closed loop control	99
A.1.2	Position loop	100
A.1.3	Speed loop	101
A.1.4	Current loop	101
A.1.5	MintDrive operational modes	101
A.1.6	Tuning the position loop for a velocity servo drive	102
A.1.7	Tuning the position loop for a servo drive	102
A.1.8	Tuning the position loop for a torque servo drive	105
A.1.9	Saving tuning information	105
B	CAN	107
B.1	Outline	107
B.1.1	MintDrive capabilities	107
B.2	CAN 1 (CANopen)	109
B.2.1	CAN 1 (CANopen) - X9	109
B.2.2	What is CANopen?	110
B.2.3	Configuring nodes	111
B.2.4	Network manager - node 1	111
B.2.5	Scanning nodes	111
B.2.6	Connecting to nodes	112
B.2.7	Monitoring CAN events	113
B.2.8	Controller nodes	114
B.2.9	I/O nodes	115
B.2.10	HMI Operator Panels	117
B.3	CAN 2 (Baldor CAN)	119
B.3.1	CAN 2 (Baldor CAN) - X8	119
B.3.2	Preparing the MintDrive	120
B.3.3	Preparing the CAN peripheral	120
B.3.4	Connecting the PC, MintDrive and CAN peripheral	120
B.3.5	Node IDs	121
B.3.6	Static configuration	121
B.3.7	Adding the node to the network	122
B.3.8	Monitoring CAN Bus communications	123
B.3.9	Controlling the CAN peripheral	123
B.3.10	Normal operation	123
B.3.11	KeypadNode	124
B.3.12	ioNode 24/24	125
B.3.13	Example CAN network	126
B.3.14	Mint CAN related keywords	127

C	CE Guidelines	129
C.1	Outline	129
C.1.1	Declaration of Conformity	129
C.1.2	EMC Conformity and CE marking	130
C.1.3	Use of CE compliant components	130
C.1.4	EMC wiring technique	130
C.1.5	EMC installation suggestions	131
C.1.6	Wiring of shielded (screened) cables	132
D	Accessories and options	135
D.1	Outline	135
D.1.1	Cables	135
D.1.2	Resolver feedback cable	136
D.1.3	EMC mains filters	137
D.1.4	Regeneration resistors	139
D.1.5	Breakout board - X5	140

1.1 MintDrive features

The MintDrive combines a powerful fully featured motion controller and brushless servo amplifier into a compact package. This provides a flexible and powerful motion control solution for almost any single axis positioning system. Programmable in Mint™, applications can be quickly realized. Using the onboard CAN bus, drives can be connected together for loosely coupled multi-axis systems.

Features include:

- Single axis AC brushless drive with integrated Mint controller
- 2.5A to 15A continuous current ratings (model dependent)
- Direct on line connection to 115V or 230V single input or 230V three phase input (model dependent)
- Programmable in Mint
- Point to point moves, software cams and gearing
- 18 optically isolated digital inputs
- 9 optically isolated digital outputs
- 4 general purpose analog inputs
- 4 general purpose analog outputs
- CANopen protocol for peer-to-peer communications with other Mint v4 controllers, and other third party devices.
- Proprietary CAN protocol for control of Baldor remote I/O devices
- RS232 and RS485 communications
- Flash memory for program and data storage.

MintDrive will operate with a large number of brushless servo motors. For information on selecting Baldor servo motors, please see the sales catalog BR1202.

This manual is intended to guide you through the installation of MintDrive, whether you are a novice in the field of motion control or an experienced engineer.

The chapters should be read in sequence.

The *Basic Installation* section describes the mechanical installation of the MintDrive, the power supply connections and motor connections. The following sections require knowledge of the low level input/output requirements of the installation and an understanding of computer software installation. If you are not qualified in these areas you should seek assistance before proceeding.

1.2 Receiving and inspection

When you receive your MintDrive, there are several things you should do immediately:

1. Check the condition of the shipping container and report any damage immediately to the carrier that delivered your MintDrive.
2. Remove the MintDrive from the shipping container and remove all packing material. The container and packing materials may be retained for future shipment.
3. Verify that the catalog number of the MintDrive you received is the same as the catalog number listed on your purchase order. The catalog/part number is described in the next section.
4. Inspect the MintDrive for external damage during shipment and report any damage to the carrier that delivered your MintDrive.
5. If MintDrive is to be stored for several weeks before use, be sure that it is stored in a location that conforms to the storage humidity and temperature specifications shown on page 83.

1.2.1 Identifying the catalog number

MintDrives are available with different current ratings and package sizes.

The catalog number describing the model is marked on a label on the side of the unit.

It is a good idea to look for the catalog number (sometimes shown as ID/No:) and write it in the space provided below.

Catalog number: **MD** _____ - _____

Installed at: _____

Date: _____

A description of a catalog number is shown below, using the example number **MD1A05TB-RC23**:

	Meaning	Alternatives
MD	The unit is a member of the MintDrive family.	-
1	Requires an AC supply voltage of 115 Volts.	2 =230V
A05	Continuous current rating of 5.0A.	A02 =2.5A; A07 =7.5A; A10 =10A; A15 =15A
T	Built in mains power supply.	S =Built in mains power supply with DC out for powering other drives
B	Dynamic Brake with a built in transistor and resistor (available on 2.5A and 5A models only).	R =Requires external braking resistor
R	Feedback option is a resolver.	E =Encoder
C	CAN Bus option (MintDrive is always fitted with CAN).	-
2	Serial port type is combined RS232 / RS485.	-
3	Additional 24VDC supply is required to power the internal MintDrive logic*.	0 =Self generated internal 24VDC logic supply*

* An external 24VDC supply will always be required to operate the enable input and digital inputs on connectors X13 and X5. See pages 26, 35 and 37.

1.3 MintDrive indicators

1.3.1 Monitor LED display



The 7-segment Monitor LED display indicates general MintDrive status information:

-	Drive Disabled	E	Drive in error (see section 7)
8	Drive Enabled	7	Follow mode
J	Jogging	L	Local (see troubleshooting guide)
P	Positional Move i.e. MOVEA, MOVER	F	Flying shear
H	Homing	C	Cam
I	Incremental move i.e. INCA, INCR	S	Speed Demand
9	Torque mode	U	Firmware being updated by WorkBench

1.3.2 CAN 1 and 2 LEDs



The CAN 1 and 2 LEDs refer to the independent CAN buses CAN1 and CAN2.

Green	The bus is operational
Red/ Green	The bus is passive (see page 94)
Red	The bus is OFF (see page 94)
Off	No primary power to the MintDrive

1.3.3 Ready LED



The front panel **Ready** LED indicates the general status of the MintDrive.

Green	The MintDrive is operating normally
Red	An error condition exists (see page 91)
Off	No primary power to the MintDrive

1.3.4 DB On (Regeneration Load) LED



The front panel **DB On** LED indicates regeneration activity.

Yellow	Power is being dissipated into the regeneration resistor
Off	No regeneration occurring

1.4 Units and abbreviations

The following units and abbreviations are used in this manual:

V Volt (also VAC and VDC)
W Watt
A Ampere
 Ω Ohm
pF picofarad
mH millihenry

ϕ phase
ms millisecond
 μ s microsecond
ns nanosecond

Kbaud kilobaud (the same as Kbit/s in most applications)
MB megabytes
CDROM Compact Disc Read Only Memory
CTRL+E on the PC keyboard, press **Ctrl** then **E** at the same time.

mm millimeter
m meter
" inch
ft feet
lbin pound-inch (torque)
Nm Newton-meter (torque)

ADC Analog to Digital Converter
AWG American Wire Gauge

2.1 Outline

You must read all the sections in *Basic Installation*.

It is important that the correct steps are followed when installing the MintDrive. This section covers the mechanical and electrical installation of the MintDrive, including the following steps:

- Location considerations
- Mounting the MintDrive
- Connecting the power supply
- Connecting the optional control supply
- Connecting the motor
- Installing a regeneration resistor
- Connecting the feedback signal
- Connecting the drive enable signal.

Each step should be followed in sequence.

2.1.1 Hardware requirements

The components you will need to complete the basic installation are described below:

- Under some applications, such as those with high deceleration rates, there may be a requirement for a dynamic brake (or regeneration) resistor.

Note: Without the braking resistor, the drive may produce an overvoltage fault.

All MintDrives have overvoltage sensing circuitry, but only the 2.5A and 5A units have an integral regeneration resistor. For 7.5A, 10A and 15A units a regeneration resistor must be purchased separately if required. See Appendix D.

- A PC that fulfills the following specification:

	Minimum specification	Recommended specification
Processor	Intel Pentium 133MHz	Intel Pentium 200MHz or faster
RAM	32MB	64MB
Hard disk space	40MB	60MB
CD-ROM	A CD-ROM drive is required	
Screen	800 x 600, 256 colors	1024 x 768, 256 colors
Mouse	A mouse or similar pointing device is required	
Operating system	Windows 95, Windows 98, Windows ME, Windows NT or Windows 2000	

- The servo motor that will be connected to the MintDrive.
- The appropriate motor cable. For easier installation it is recommended that a color-coded Baldor motor power cable is used. A description of a Baldor motor power cable catalog number is shown below, using the example number **CBL030SP-MHM**:

	Meaning	Alternatives
CBL	The item is a cable.	-
030	Indicates the length, in this example 3.0 meters.	Various lengths are available
SP	The cable is a S ervo motor P ower cable.	-
M	Current rating of 10A.	F =20A; E =30A
H	8-pin connector	-
M	Metric style threaded connector	CE =CE connector

Motor power cables are also available without connectors, in which case the last two letters (HM in the example above) are not used.

- A resolver 9-core cable, 15-core if the MintDrive is fitted with the encoder option. A description of a feedback cable catalog number is shown below, using the example number **CBL030SF-ALM**.

	Meaning	Alternatives
CBL	The item is a cable.	-
030	Indicates the length, in this example 3.0 meters.	Various lengths are available
SF	The cable is a S ervo motor F eedback cable.	-
A	Suitable for resolver feedback	K =Suitable for Encoder / Hall feedback
L	12-pin connector	-
M	Metric style threaded connector	CE =CE connector

If you are not using a Baldor cable with your chosen feedback device, be sure to obtain a cable that is a shielded twisted pair 22 AWG (0.34mm²) wire minimum, with an overall shield. Ideally, the cable should not exceed 66ft (20m) in length. Maximum wire-to-wire or wire-to-shield capacitance is 50pF per foot (300mm) (maximum of 7500pF for 150ft).

- An RS232 cable (Baldor order code CBL023-501), or the components to build one yourself.
 - Note:** As the RS232 connector is shared with the RS485 port, a standard serial cable must not be used as this may result in damage to the unit. See pages 44 and 45.
- (Optional) A break-out board (catalog number OPT017-501) for input/output from connector X5.
- A mains cable.

2.1.2 RS485 / RS422 systems

If your PC does not have an RS485 / RS422 connector, an RS232 to 4-wire RS485 / RS422 converter will be required. This allows signals from the RS232 port to be converted to the signals necessary for RS485 / RS422 communications. Appropriate converters are available from KK Systems Ltd (www.kksystems.com).

Note: If this is the first time you are installing a MintDrive then it is strongly recommended that you use RS232 to get started and use RS485 later. This will avoid any potential problems involving the RS232-RS485 converter.

Also, MME (Mint Motion Engine) firmware can only be updated over RS232.

2.1.3 Power sources

If the MintDrive requires an external 24VDC for the logic supply then this must be a regulated power supply with a minimum current supply capability of 1.6A. A 24V filter may be required to comply with the CE directive for which the MintDrive was tested (see page 18).

A 24VDC power supply is required for the drive enable input, the digital outputs and the digital inputs; 24V cannot be sourced from the MintDrive unit itself.

A mains source (installation over-voltage category III or less) in the installation area is required.

This will need to be single or three phase depending upon the type of MintDrive. A mains filter is required to comply with the CE directive for which the MintDrive was tested (see page 18).

2.1.4 Tools and miscellaneous hardware

- Your PC operating system user manual might be useful if you are not familiar with Windows
- A small screwdriver with a blade width less than 1/8" (3.5mm)
- Screws or bolts (depending on your own mounting requirements) with an M5 fixing
- Soldering equipment with suitable soldering tips.

2.1.5 Other information needed for installation

You will need the following information to complete the installation:

- The data sheet or manual provided with your motor, describing the wiring information of the motor cables/connectors
- Whether digital inputs/outputs will be 'Active Low' or 'Active High' to meet the requirements and specification of the system you are going to build.

2.2 Mechanical installation and location requirements

It is essential that you read and understand this section before beginning the installation.



CAUTION: To prevent equipment damage, be certain that the input power has correctly rated protective devices installed.



CAUTION: To prevent equipment damage, be certain that input and output signals are powered and referenced correctly.



CAUTION: To ensure reliable performance of this equipment be certain that all signals to/from the MintDrive are shielded correctly.



CAUTION: Avoid locating the MintDrive immediately above or beside heat generating equipment, or directly below water steam pipes.



CAUTION: Avoid locating the MintDrive in the vicinity of corrosive substances or vapors, metal particles and dust.

The safe operation of this equipment depends upon its use in the appropriate environment. The following points must be considered:

- The MintDrive must be installed indoors, permanently fixed and located so that it is not accessible by the operator and can only be accessed by service personnel using tools.
- The maximum suggested operating altitude is 3300ft (1000m). Above 3300ft (1000m) de-rate output current 2% per 1000ft (300m).
- The MintDrive must be installed in an ambient temperature of 32°F to 104°F (0°C to 40°C). De-rate output current 2.5% per 1.8°F (1°C) from 104°F (40°C) to 122°F (50°C) maximum.
- The MintDrive must be installed in relative humidity levels of less than 80% for temperatures up to 87°F (31°C) decreasing linearly to 50% relative humidity at 104°F (40°C) (non-condensing).
- The MintDrive must be installed where the pollution degree according to IEC664 shall not exceed 2.
- For MintDrives that require an external 24VDC for the logic supply, it must be installed so that the 24VDC supplied to the unit is isolated from the mains using double or reinforced insulation.
- The inputs and outputs of the control circuit must be confined to Safety Extra Low Voltage circuits.
- Both the mains supply and the external 24VDC supply must be fused.
- The atmosphere shall not contain flammable gases or vapors.
- There shall not be abnormal levels of nuclear radiation or X-rays.
- The MintDrive must be secured by the slots in the flange, with the protective earth stud bonded to a safety earth by either a 25A conductor or a conductor of three times the peak current rating - whichever is the greater.
- For effective cooling and maintenance, the MintDrive should be mounted on a smooth, non-flammable vertical surface. The power handling capability is affected by the temperature of the left hand side of the unit. Ensure a free flow of air is available to maintain the control electronics at a suitable temperature.
- At least 2" (50mm) top and bottom clearance of the MintDrive must be provided for airflow.

- If multiple units are being mounted side by side, a spacing of 0.5" (13mm) must be provided between the units and from the unit to the side of the cabinet / enclosure.
- To comply with CE directive 89/336/EEC an appropriate mains filter must be installed. For MintDrives requiring the external 24VDC logic supply, a 24V filter must also be installed. See page 18.

2.2.1 Dimensions and mounting

Ensure you have read and understood page 8. Mount the MintDrive on its rear side, the side opposite to the front panel. The MintDrive must be mounted upright to ensure adequate cooling (you can check this by ensuring that the Hazardous Voltages warning information is clearly readable to you). M5 bolts or screws should be used to mount the unit.

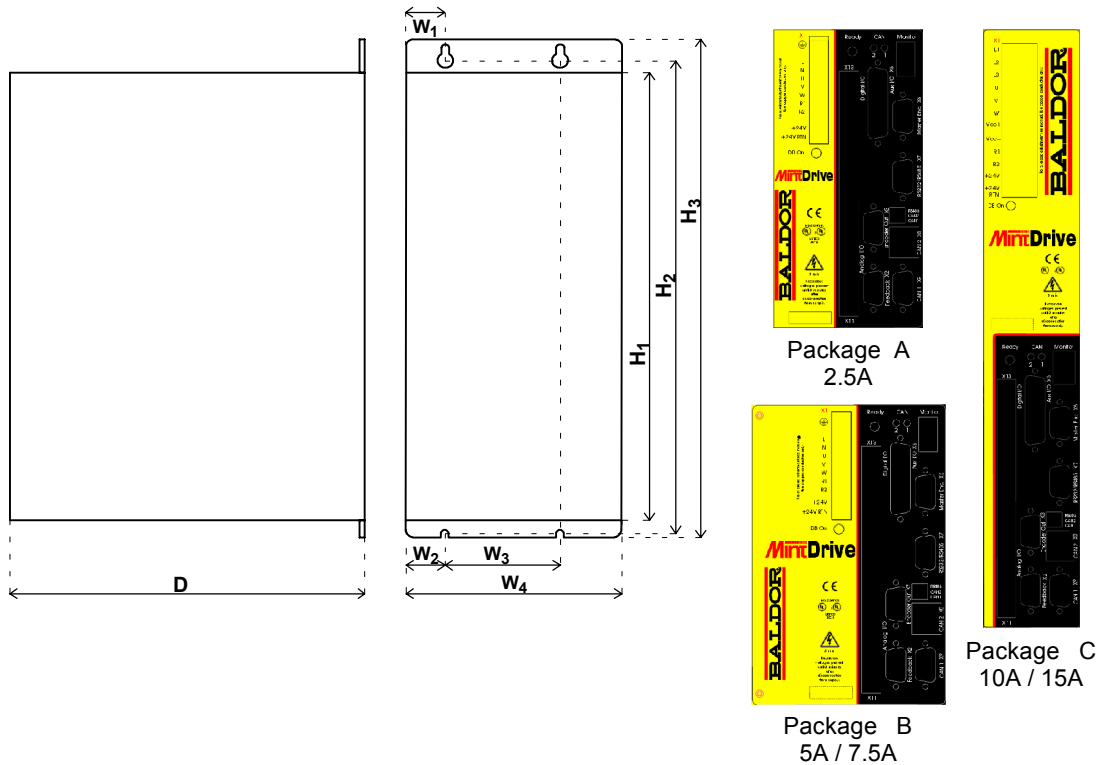

Package	Current	Dimensions inches (mm)								Weight lb (kg)
		H1	H2	H3	W1	W2	W3	W4	D	
A	2.5A	6.81 (173)	7.67 (195.5)	8.07 (205)	0.6 (15)	0.6 (15)	1.57 (40)	3.31 (84)	6.00 (152)	4.89 (2.22)
B	5A / 7.5A	6.81 (173)	7.67 (195.5)	8.07 (205)	0.9 (23)	0.9 (23)	1.57 (40)	4.29 (109)	6.00 (152)	5.31 (2.41)
C	10A / 15A	14.05 (357)	15.12 (384)	15.75 (400)	1.1 (27.5)	0.37 (9.5)	1.42 (36)	2.17 (55)	10.43 (265)	9.92 (4.5)

Figure 1 - Package dimensions

2.3 Power connections

This section provides instructions for connecting the mains supply. It is important that you refer to the correct front panel for your MintDrive package.

The installer of this equipment is responsible for complying with NEC (National Electric Code) guidelines or CE (Conformite Europeene) directives and application codes that govern wiring protection, grounding, disconnects and other current protection.



WARNING: Electrical shock can cause serious or fatal injury. Do not touch any power device or electrical connection before you first ensure that power has been disconnected and there is no high voltage present from this equipment or other equipment to which it is connected.

The power supply module within the MintDrive provides rectification, smoothing, regeneration capability (built-in on 2.5A and 5A models only) and current surge protection.

The power stage is internally fused and therefore self protected, but fuses or circuit breakers may be used in the input lines for cable protection.

A power disconnect should be installed between the mains supply and the input of the MintDrive for a fail safe method to disconnect power. The MintDrive will remain in a powered condition until all input power is removed from the MintDrive and the internal bus voltage is depleted.

On units without the self generated internal 24VDC logic supply (catalog number ends with 3), you might wish the external 24VDC logic supply to remain connected to retain position and I/O information. The MintDrive with package size C can accept either single phase direct (115V or 230V depending on model) or 3 phase with transformer (250VAC max).

Note: A Residual Current Device (RCD) must not be used for fusing the drive.

All interconnection wires should be in metal conduits between the MintDrive, AC power source, motor, host controller and any operator interface stations. Use UL listed closed loop connectors that are of appropriate size for the wire gauge being used. Connectors are to be installed using only the crimp tool specified by the manufacturer of the connector. Only class 1 wiring should be used.

Baldor drives are designed to be powered from standard single and three phase lines (depending on model) that are electrically symmetrical with respect to ground. Due to the importance of system grounding for increased reliability, grounding methods are shown in the following sections.

2.3.1 Grounding

Single phase units

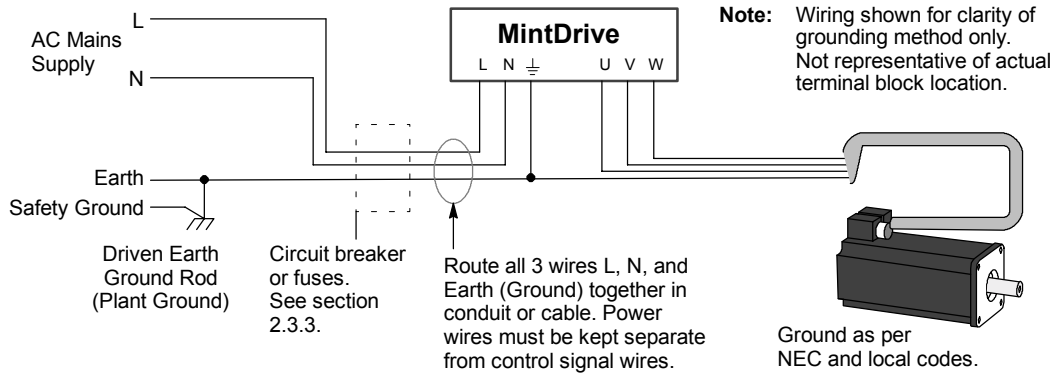

Figure 2 - Recommended single phase system grounding

Note: For CE compliance, a 3-phase mains filter must be connected between the mains supply and the MintDrive. The MintDrive and motor earths should be connected to the enclosure backplane. (The enclosure backplane should be connected to the earth at the mains source. There should be a separate connection from the earth at the mains source to the plant ground rod).

Three phase units

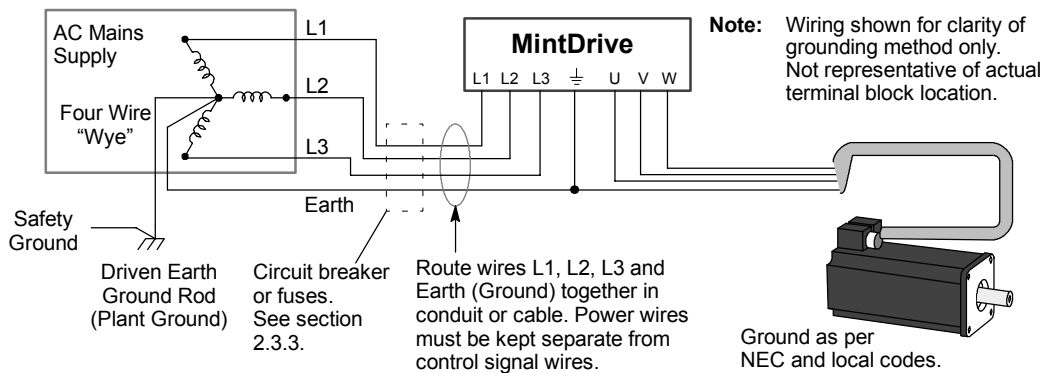

Figure 3 - Recommended 3-phase system grounding

Note: For CE compliance, a 3-phase mains filter must be connected between the mains supply and the MintDrive. The MintDrive and motor earths should be connected to the enclosure backplane. (The enclosure backplane should be connected to the earth at the mains source. There should be a separate connection from the earth at the mains source to the plant ground rod).

Ungrounded distribution systems

To avoid equipment damage an isolation transformer with a grounded secondary is recommended. This provides three phase AC power that is symmetrical with respect to ground.

2.3.2 Input power conditioning

Baldor drives are designed for direct connection to standard single and three phase lines that are electrically symmetrical with respect to ground. Certain power line conditions must be avoided; an AC line reactor, an isolation transformer or a step up/step down transformer may be required for some power conditions.

- If the feeder or branch circuit that provides power to the MintDrive has permanently connected power factor correction capacitors, an input AC line reactor or an isolation transformer must be connected between the power factor correction capacitors and the MintDrive.
- If the feeder or branch circuit that provides power to the MintDrive has power factor correction capacitors that are switched on line and off line, the capacitors must not be switched while the drive is connected to the AC power line. If the capacitors are switched on line while the drive is still connected to the AC power line, additional protection is required. A Transient Voltage Surge Suppressor (TVSS) of the proper rating must be installed between the AC line reactor (or isolation transformer) and the AC input to the MintDrive.

2.3.3 Power disconnect and protection devices

A power disconnect should be installed between the input power service and the MintDrive for a fail-safe method to disconnect power. The MintDrive will remain in a powered condition until all input power is removed from the drive and the internal bus voltage has depleted.

The MintDrive must have a suitable input power protection device installed. Recommended circuit breakers are thermal magnetic devices (1 or 3 phase as required) with characteristics suitable for heavy inductive loads (D-type trip characteristic). Recommended time delay fuses are Buss FRN on 230VAC or equivalent, following the UL 508C recommendation of a fuse size of four times the continuous output current of the drive. Dual element, time delay fuses should be used to avoid nuisance trips due to inrush current when power is first applied.

For CE installations the Gould Shawmut Cat. No. ATMR15 may be suitable, up to 15A.

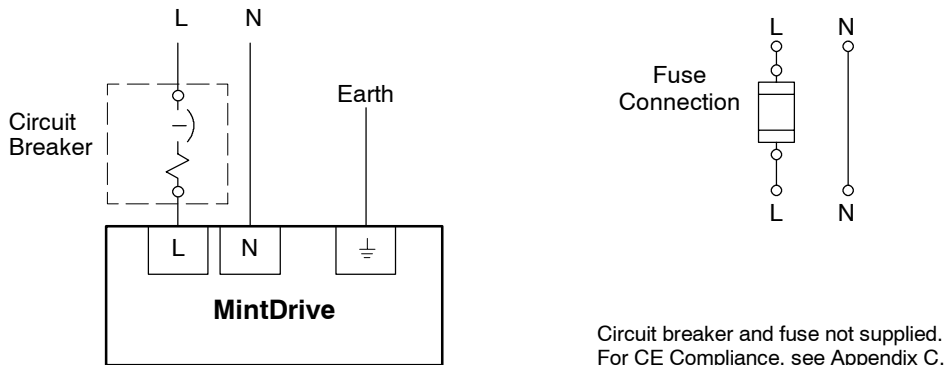

Circuit breaker and fuse not supplied.
For CE Compliance, see Appendix C.

Figure 4 - Circuit breaker and fuse, single phase, package size A or B

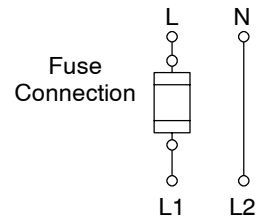
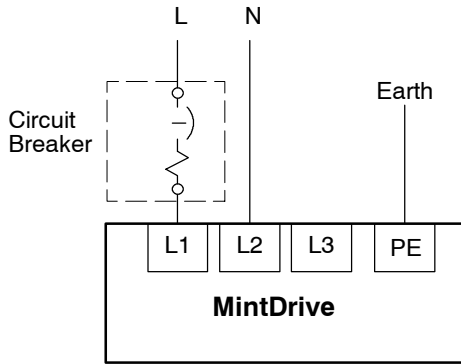

Circuit breaker and fuse not supplied.
For CE Compliance, see Appendix C.

Figure 5 - Circuit breaker and fuse, single phase, package size C

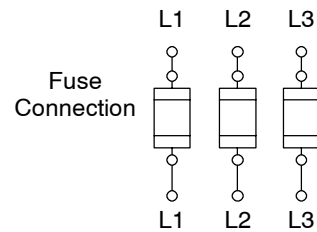
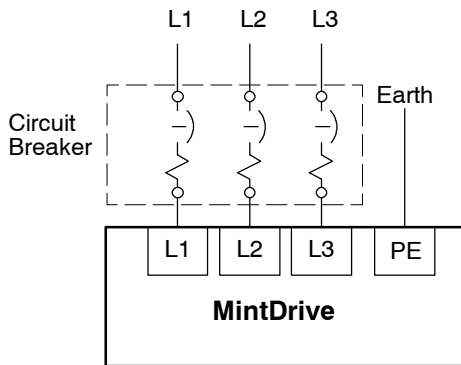

Circuit breaker and fuse not supplied.
For CE Compliance, see Appendix C.

Figure 6 - Circuit breaker and fuse, three phase, package size C

Note: Metal conduit or shielded cable should be used. Connect conduits so the use of a Reactor or RC Device does not interrupt EMI/RFI shielding. If local codes do not specify different regulations, use the same gauge wire for Earth ground as is used for L and N. Connect earth to the backplane of the enclosure.

2.3.4 Wire sizes

Input and output wire size is based on the use of copper conductor wire rated at 167°F (75°C). The following tables describe the wire size to be used for power connections and the ratings of the protection devices.

Catalog Number	Incoming Power					
	Nominal Input Voltage	Continuous Output Amps (RMS)	D-Type Input Breaker (A)	Input Fuse Time Delay (A)	Wire Gauge	
					AWG	mm ²
MD1A02xx-xxxx	115V (1φ)	2.5A	6	6	14	2.5
MD2A02xx-xxxx	230V (1φ)	2.5A	6	6	14	2.5
MD1A05xx-xxxx	115V (1φ)	5A	10	10	14	2.5
MD2A05xx-xxxx	230V (1φ)	5A	10	10	14	2.5
MD1A07xx-xxxx	115V (1φ)	7.5A	16	16	14	2.5
MD2A07xx-xxxx	230V (1φ)	7.5A	16	16	14	2.5
MD1A10xx-xxxx	115V (1φ)	10A	20	20	14	2.5
MD2A10xx-xxxx	230V (3φ)	10A	20	20	14	2.5
MD1A15xx-xxxx	115V (1φ)	15A	32	32	12	2.5
MD2A15xx-xxxx	230V (3φ)	15A	32	32	12	2.5

Note: All wire sizes are based on 75°C copper wire. Higher temperature smaller gauge wire may be used per NEC and local codes. Recommended fuses/breakers are based on 77°F (25°C) ambient, maximum continuous control output current and no harmonic current.

2.3.5 Single phase connection to package size A or B

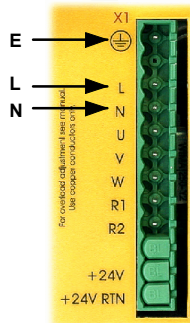

Location	Connector X1, single or 2-part connector	
Part number	MD1A...	MD2A...
Input voltage	115VAC, 1 ϕ line to neutral	230VAC, 1 ϕ line to neutral
Range	97-125VAC	220-250VAC

Note: For single phase connection, the voltage ripple on the DC-bus is 25Vp-p for 5A (the peak current for a 2.5A MintDrive) and 50Vp-p for 10A (the peak current for a 5A MintDrive). This can limit the maximum speed of the motor.
Tightening torque for terminal block connections is 4.4~5.3 lbin (0.5~0.6Nm).
The threaded holes in the top and bottom of the enclosure are for cable clamps (provided).
The holes are threaded for M4 bolts no longer than 0.47" (12mm) in length. Longer bolts may short circuit the electrical components inside the MintDrive.

2.3.6 Single phase connection to package size C

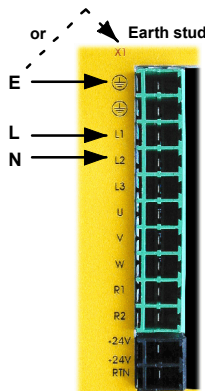

Location	Connector X1, single or 2-part connector	
Part number	MD1A...	MD2A...
Input voltage	115VAC, 1 ϕ line to neutral	230VAC, 1 ϕ line to neutral
Range	97-125VAC	220-250VAC

Note: For single phase connection, the voltage ripple on the DC-bus is 25Vp-p for 5A (the peak current for a 2.5A MintDrive) and 50Vp-p for 10A (the peak current for a 5A MintDrive). This can limit the maximum speed of the motor.
Tightening torque for terminal block connections is 4.4~5.3 lbin (0.5~0.6Nm).
The threaded holes in the top and bottom of the enclosure are for cable clamps (provided).
The holes are threaded for M4 bolts no longer than 0.47" (12mm) in length. Longer bolts may short circuit the electrical components inside the MintDrive.

2.3.7 Three phase connection to package size C

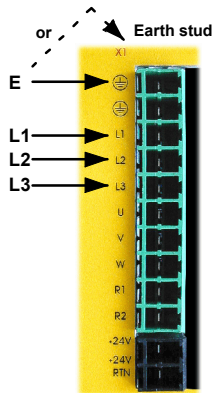

Location	Connector X1, single or 2-part connector
Part number	MD2A...
Input voltage	230VAC, 3φ line to line
Range	220-250VAC

Note: Tightening torque for terminal block connections is 4.4~5.3 lbin (0.5~0.6Nm).
 The threaded holes in the top and bottom of the enclosure are for cable clamps (provided).
 The holes are threaded for M4 bolts no longer than 0.47" (12mm) in length. Longer bolts may short circuit the electrical components inside the MintDrive.

2.3.8 24V control supply

Depending on model, a 24VDC control supply may be required to provide power to the control electronics when power is removed from the amplifier (see page 2). This is useful for safety where power needs to be removed from the amplifier stage but the control electronics must be powered to retain position and I/O information. The 24VDC supply is connected via X1.

Note: A 24VDC supply is always required for the drive enable input on connector X13.

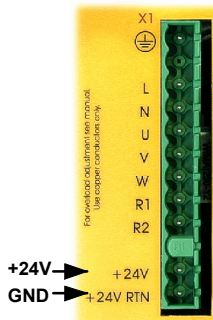

Location	Connector X1, single or 2-part connector
Part number	MDxxxxxx-xxx3
Input voltage	24V
Input current	1.6A (maximum)
Range	20.4 - 28.8VDC

Note: Tightening torque for terminal block connections is 4.4~5.3 lbin (0.5~0.6Nm)

2.3.9 DC Bus power connections from package size C

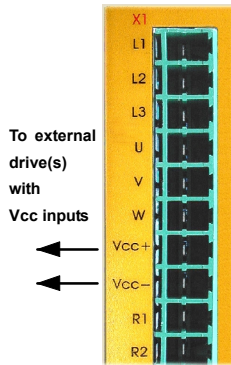

Location	Connector X1, single or 2-part connector	
Part number	MD1AxxSx...	MD2AxxSx...
Output voltage	160VDC	320VDC
Range	135-176VDC	306-350VDC

The MintDrive 10A and 15A variants are available with a DC bus supply output for powering other drives that do not have their own internal mains power supplies. This power is available on the X1 connector pins Vcc+ and Vcc-.

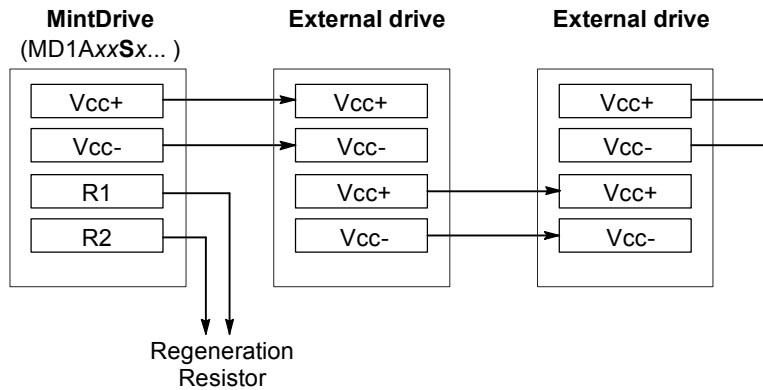

Note: It is important to ensure that the total current required by the powering drive, the external drive(s) and their maximum combined loads does not exceed the current rating of the powering drive.

Tightening torque for terminal block connections is 4.4~5.3 lbin (0.5~0.6Nm). The threaded holes in the top and bottom of the enclosure are for cable clamps (provided). The holes are threaded for M4 bolts no longer than 0.47" (12mm) in length. Longer bolts may short circuit the electrical components inside the MintDrive.

2.3.10 Power supply filters

To comply with EEC directive 89/336/EEC, a mains filter of the appropriate type must be connected. This will ensure that the unit complies with the CE specifications for which it has been tested. If the MintDrive has the 24VDC input power supply option then a further filter will be necessary to comply with CE specifications. Schaffner filters are recommended, with part numbers shown below:

	Voltage	
	230VAC, 1 ϕ	115VAC, 1 ϕ
MintDrive current rating 2.5A	FN2070-10-06	FN9675-3-06
5A	FN2070-6-06	FN2070-10-06
7.5A	FN2070-10-06 (Use FN2070-12-06 if 24V option is fitted)	FN2070-12-06
	230VAC, 3 ϕ	-
10A	FN351-36-33	-
15A	FN351-50-33	-
	24VDC	
All models	FN9675-3-06	

Table 1 - Schaffner filter part numbers

See Appendix D, section D.1.3 for details of filter dimensions and Baldor catalog numbers.

2.4 Motor connections

This section provides instructions for connecting the motor.

Location	Connector X1, single or 2-part connector	
Part number	MD1A...	MD2A...
Nominal output voltage	160VDC	320VDC
Range	135-176VDC	306-350VDC

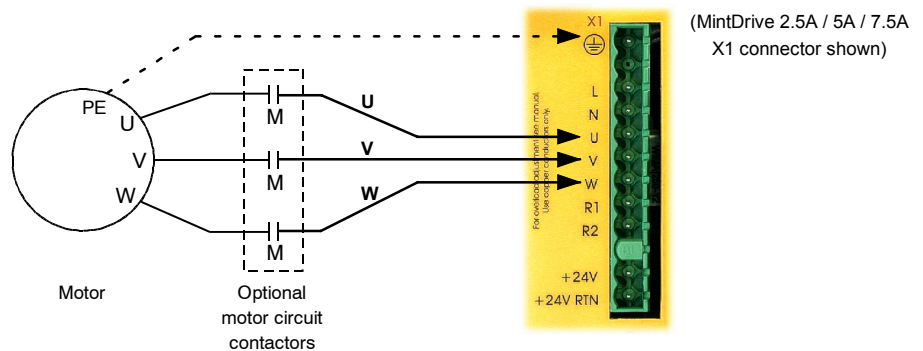

CAUTION: Do not connect power to the MintDrive UVW outputs. The MintDrive might be damaged.

CAUTION: The motor leads U, V and W must be connected to their corresponding U, V or W terminal on the motor. Mis-connection will result in uncontrolled motor movement.

All cables must be shielded. The maximum allowable cable length is 82ft (25m).

Note: For CE compliance the MintDrive and motor earth should be connected to the enclosure backplane. (The enclosure backplane should be connected to the earth at the mains source. There should be a separate connection from the earth at the mains source to the plant ground rod).

2.4.1 Motor circuit contactors

If required by local codes or for safety reasons, an M-Contactor (motor circuit contactor) may be installed to provide a physical disconnection of the motor windings from the MintDrive (see page 19). Opening the M-Contactor ensures that the MintDrive cannot drive the motor, which may be necessary during equipment maintenance or similar operations.

Under certain circumstances, it may also be necessary to fit a brake to the motor. This is important with hanging loads where disconnecting the motor windings could result in the load falling. Contact Baldor for details on appropriate brakes.



CAUTION:

If an M-Contactor is installed, the MintDrive must be disabled at least 20ms before the M-Contactor is opened. If the M-Contactor is opened while the MintDrive is supplying voltage and current to the motor, the MintDrive may be damaged. Incorrect installation or failure of the M-Contactor or its wiring may result in damage to the MintDrive.

2.4.2 Regeneration resistor (Dynamic Brake resistor)

The 2.5A and 5A MintDrives both have internally fitted regeneration resistors*. For 7.5A, 10A and 15A MintDrives, an external regeneration (Dynamic Brake) resistor must be installed to dissipate excess power from the internal DC bus during motor deceleration.



WARNING: A regeneration resistor may generate enough heat to ignite combustible materials. To avoid fire hazard, keep all combustible materials and flammable vapors away from the brake resistors.

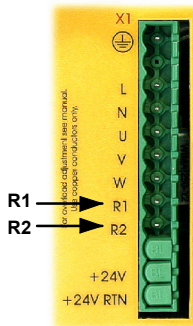

Location	Connector X1, single or 2-part connector		Resistor power rating
	Voltage		
MintDrive current rating	230VAC	115VAC	
7.5A	RG39	RG22	100W
10A	RG10	RG4.7	320W
15A	RG10	RG4.7	

Table 2 - Baldor regeneration resistor catalog numbers

All the regeneration resistors listed in section D.1.4 on page 139 are completely assembled and enclosed in a IP21/NEMA 1 rated enclosure.

* Additional resistors connected to R1 and R2 will be connected in parallel with the internal resistor.

2.4.2.1 Regeneration resistor mounting

The regeneration resistor should be mounted near the top of an enclosure to maximize heat dissipation. When the motor regenerates, the yellow **DB On** LED on the front panel of the MintDrive will illuminate while the voltage is exceeding the safe limit. See section D.1.4 on page 139.

2.5 Feedback connections

Two feedback options are available; a commutating encoder or a resolver, both using connector X2. Check with the catalog number (see page 2) to ensure you are wiring the correct feedback device.

Resolver based MintDrives provide a simulated encoder output signal available on connector X3 for master/slave type applications. Encoder based MintDrives duplicate the encoder signals entering X2.

The following points must be observed when wiring the feedback device:

- The feedback device wiring must be separated from power wiring
- Parallel runs of the device wiring must be separated from power cables by at least 3" (76mm)
- Power wires must be crossed at right angles only
- To prevent contact with other conductors or grounds, ungrounded ends of shields must be insulated.

2.5.1 Resolver option

The resolver connections are made using the 15-pin D-type female connector X2. Twisted pair cables must be used for the complementary signal pairs e.g. SIN+ and SIN-. The overall cable screen/shield must be connected to the metallic shell of the D-type connector.

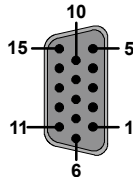

Location	Connector X2, 15-pin D-type female connector	
	Pin	Resolver function
	1	SIN+
	2	COS+
	3	REF+
	4~5	(not connected)
	6	SIN-
	7	COS-
	8	REF-
	9~10	(not connected)
	11	External index
	12	(not connected)
	13	Analog ground
	14~15	(not connected)

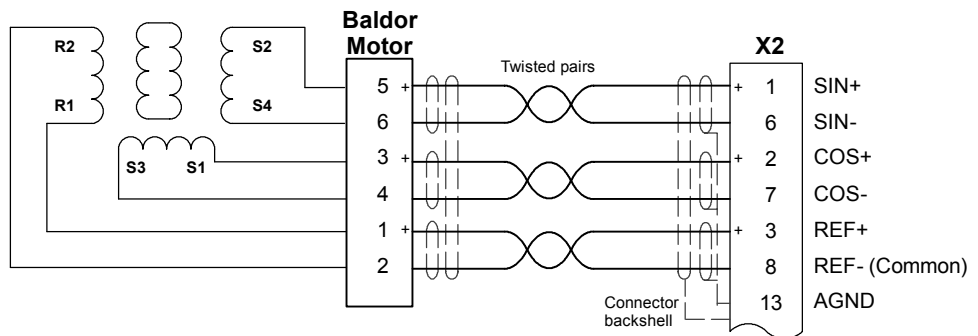
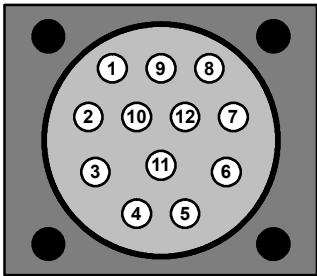

Figure 7 - Resolver cable connections

2.5.1.1 Resolver cable pin configuration

The table and diagram below show the pin configuration for a typical Baldor Resolver Feedback cable, part number CBL030SF-ALM.

Signal name	X2 pin	Motor / cable pin	Resolver cable wire color
REF+	3	1	Red
REF-	8	2	Blue
COS+	2	3	Green
COS-	7	4	Yellow
SIN+	1	5	Pink
SIN-	6	6	Grey



Motor resolver connector
(male)

Pins 7~12 are
not used

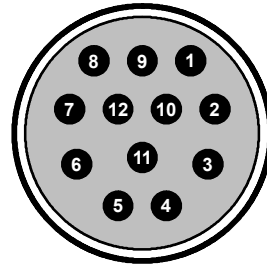

Cable connector end view
(female)

Figure 8 - Baldor motor resolver cable pin configuration

2.5.2 Encoder option

The encoder connections are made using the 15-pin D-type female connector X2. This provides the ABZ channels and Hall signals. Twisted pair cables must be used for the complementary signal pairs e.g. CHA+ and CHA-. The overall cable screen/shield must be connected to the metallic shell of the D-type connector.

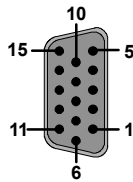

Location	Connector X2, 15-pin D-type female connector	
	Pin	Encoder function
	1	CHA+
	2	CHB+
	3	CHZ+
	4	Hall U+
	5	Hall U-
	6	CHA-
	7	CHB-
	8	CHZ-
	9	Hall W+
	10	Hall V+
	11	+5V
	12	(not connected)
	13	DGND
	14	Hall W-
	15	Hall V-

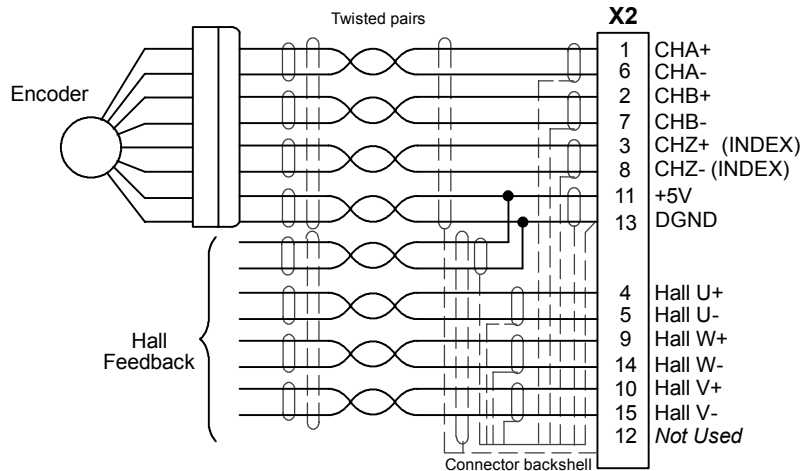
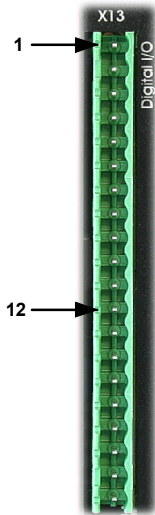

Figure 9 - Encoder cable connections

2.6 Drive enable

To operate the MintDrive, the drive stage must be active and enabled. This requires an externally generated 24VDC supply to be connected between pins 1 and 12. This connection can be wired directly or through an intermediate switch; if a switch is used it should always be used to switch the signal to pin 1, with the signal to pin 12 being hard-wired.



Location	Connector X13, pins 1 & 12
Name	Drive enable
Input voltage	+24VDC ($\pm 20\%$)

Note: The drive enable connection controls the sense of the digital inputs DIN10 to DIN17 (see pages 35 to 37).

Active high: To cause the digital inputs to be active high (active when a voltage of +24VDC is applied to them) connect +24VDC to pin 1 and 0V to pin 12.

Active low: To cause the digital inputs to be active low (active when grounded) connect +24VDC to pin 12 and 0V to pin 1.

The sense of the digital inputs can also be controlled through the Mint software, using the keyword `INPUTACTIVELEVEL`. For the drive to operate, it must be enabled using the Mint keyword `DRIVEENABLE` or `RESET`.

This completes the basic installation.

You should read the following sections in sequence before attempting to start the MintDrive.

3.1 Outline

This section describes the various digital and analog input and output capabilities of the MintDrive, together with descriptions of each of the associated connectors on the front panel.

The following conventions will be used to refer to the inputs and outputs:

I/O Input / Output
DIN Digital Input
DOUT Digital Output
AIN Analog Input
AOUT Analog Output

3.2 Analog I/O

The MintDrive provides:

- 4 analog inputs, 2 on the block connector X11 and 2 on the 25-pin D-type connector X5
- 4 analog outputs, 2 on the block connector X11 and 2 on the 25-pin D-type connector X5.

None of the analog I/O are optically isolated from internal generated power rails, therefore care must be taken to avoid earth loops and similar associated problems.

The input buffers do not offer any low pass filtering of the applied voltage. Any system noise presented at the input will be reflected in the value read on conversion. Therefore, each analog input signal should be connected to the system using individual screened/shielded cable (a twisted pair cable in the case of the differential inputs) with an overall shield in order to minimize these effects. The overall cable shield should then be connected to the chassis at one end. No other connection should be made to the cable shield. If any inputs are unused, then it is advisable to connect them to the AGND pin. Do not leave the inputs unconnected (floating).

3.2.1 Analog Input, Single Ended - X11

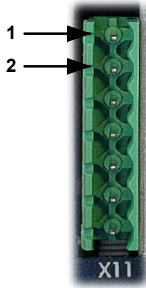

Location	Connector X11, pins 1 & 2
Name	AIN2
Mint keyword	ADC . 2
Description	Single ended input. Range: 0 - ± 10 VDC. Resolution: 9-bit with sign. Input impedance: >4 k Ω . Sampling interval: 5ms.

Note: There is a +15V reference voltage supplied on X11 pin 3 from a 1.96k Ω resistor. A linear command potentiometer of 5k Ω may be used, with X11 pin 2 connected to the wiper, and the end terminations connected to pins 1 & 3, as shown below.

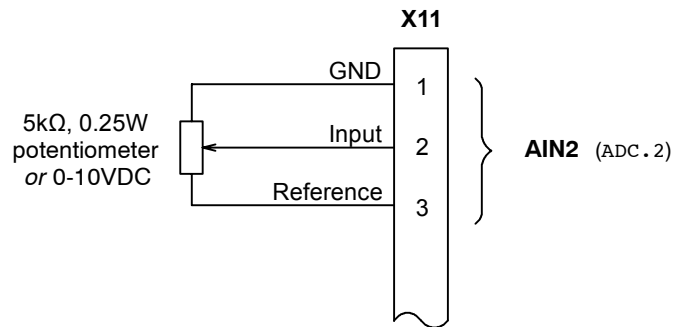
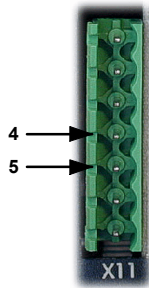

Figure 10 - AIN2 analog input wiring

3.2.2 Analog Input, Differential - X11



Location	Connector X11, pins 4 (+) & 5 (-)
Name	AIN3
Mint keyword	ADC . 3
Description	Differential input. Common mode voltage range: $\pm 10\text{VDC}$. Resolution: auto-selecting as follows: 12-bit with sign (<1V DC input) 9-bit with sign (>1V DC input) Common mode rejection: 40dB Input impedance: >5k Ω Sampling interval: 5ms Optional 4-20mA current mode (contact Baldor).

A typical input circuit is shown below:

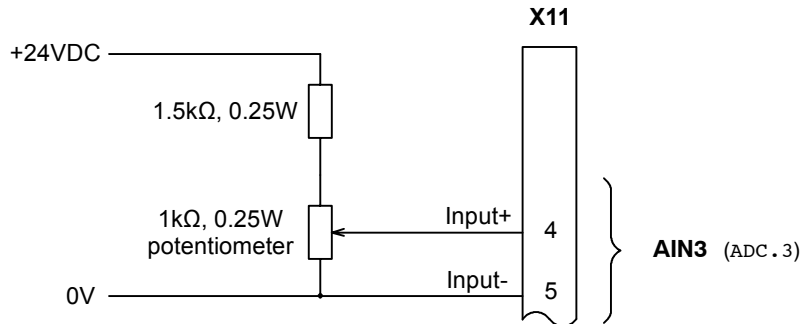

Figure 11 - AIN3 analog input

3.2.3 Analog Inputs, Differential - X5



Location	Connector X5	
Pins	8 (+) and 21 (-)	9 (+) and 22 (-)
Name	AIN0	AIN1
Mint keyword	ADC . 0	ADC . 1
Description	Two independent differential inputs. Common mode voltage range: $\pm 10\text{VDC}$. Resolution: 12-bit with sign. Common mode rejection: 40dB Input impedance: $>22\text{k}\Omega$ Sampling interval: 0.5ms - 20ms (depends upon servo loop frequency). Accuracy: better than 1%	

Typical use for these may be analog sensor inputs or to provide a low cost joy-stick interface. The guaranteed DC accuracy of the inputs is 2%. Each input is buffered individually, before being fed into separate channels of the ADC, a Maxim MAX197. There is some input protection should the input voltage exceed the maximum rating shown above, although this is for protection against transitional over-voltage; long term over-voltages will cause permanent damage. Each analog input signal should be connected to the system using a screened/shielded twisted pair cable, and the cable shield should be connected to the chassis at one end. Due to the differential characteristics of these inputs, they can provide better rejection of common mode noise provided normal good engineering practices are adhered to. No other connection should be made to the cable shield.

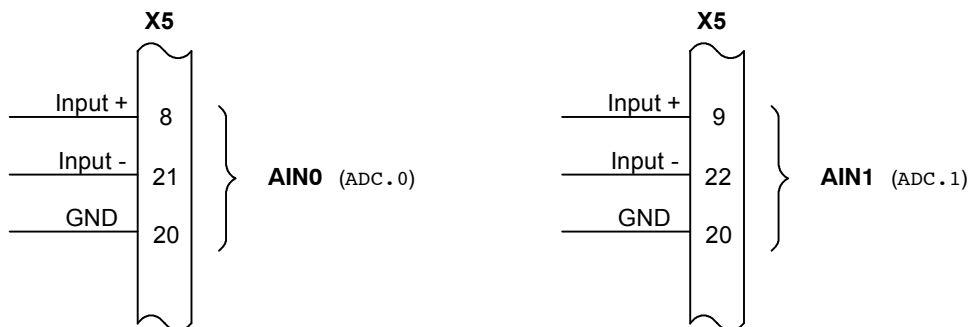

Figure 12 - AIN0 and AIN1 analog inputs

If an input is unused, then it is advisable to connect it to the AGND pin. Do not leave the input unconnected (floating).

The analog inputs can be read in Mint using the keywords `ADC . 0` and `ADC . 1`. Mint will return the value as a percentage where $0V=0\%$, $-10V= -100\%$ and $+10V = 100\%$.



CAUTION:

The isolation provided on the inputs, outputs, master encoder and CAN is nominal. The primary function of the isolation is to break earth loops. Both sides of the isolation boundary must still be kept at SELV potentials with respect to ground, i.e. the difference in the 0V rail across the isolation boundary must not exceed 30V.

3.2.4 Analog Outputs, Bipolar - X11

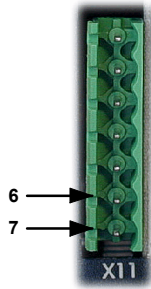

Location	Connector X11	
Pins	6	7
Name	AOUT2	AOUT3
Mint keyword	AUXDAC . 2	AUXDAC . 3
Description	Two independent assignable outputs. Output range: $\pm 10\text{VDC}$. Resolution: 8-bit with sign. Output current: 1mA maximum. Update interval: 2ms.	

Two programmable analog outputs that can be used to provide real time status of various control conditions. The voltage from the output buffer is supplied through a 50 Ω resistor for short circuit protection.

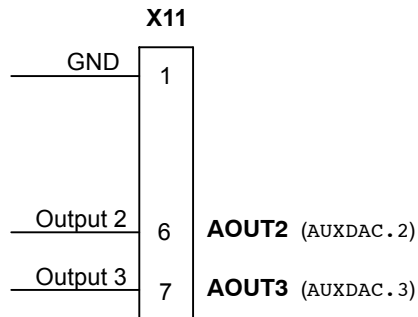

Figure 13 - AOUT2 and AOUT3 analog outputs



CAUTION:

Following power-up or a system reset, both outputs will initially be set at approximately +10V. This condition will remain, for a short period, during the software initialization process. For this reason, care should be taken if this output is being used as a drive reference for a speed controller.

3.2.5 Analog Outputs, Bipolar - X5

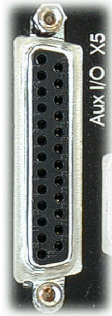

Location	Connector X5	
Pins	19	7
Name	AOUT0	AOUT1
Mint keyword	AUXDAC . 0	AUXDAC . 1
Description	Two independently controlled outputs. Output range: ± 10 VDC. Resolution: 8-bit Output current: ± 4 mA maximum Update interval: immediate, using Mint commands	

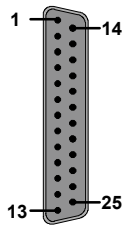

The two analog 8-bit outputs AOUT0 and AOUT1 are not isolated and are primarily intended for system debugging. Output voltages in the range of ± 10 V are achievable with a DC accuracy of better than 3%. They are derived from a high-frequency PWM pulse train from the main processor, which is subsequently filtered. These signals are buffered by an operational amplifier in the MintDrive and are capable of sinking or sourcing up to ± 4 mA. The outputs are protected by fast Schottky diodes against excessively high transitional voltages of either polarity.

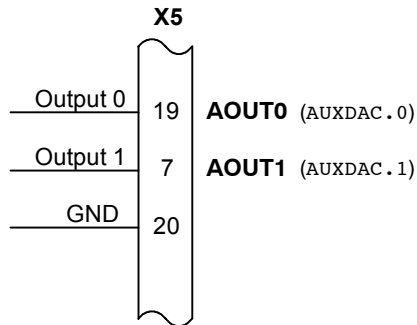

Figure 14 - AOUT0 and AOUT1 analog outputs



CAUTION:

Following power-up or a system reset, both outputs will initially be set at approximately +10V. This condition will remain, for a short period of time during the software initialization process.

3.3 Digital I/O

The MintDrive provides:

- 8 general purpose inputs on block connector X13
- 4 general purpose outputs on block connector X13
- 10 general purpose inputs on 25-pin connector X5
- 5 general purpose outputs on 25-pin connector X5

A digital input can be used to support any of the following typical functions:

- Stop input
- Home input
- Forward limit
- Reverse limit
- Interrupts (controlled from Mint)
- General purpose use

DIN0 and DIN2 are also capable of special alternative functions:

- DIN0 and DIN2 are fitted with Schmitt trigger devices and can be configured using Mint for position capture of the axis or the master or auxiliary encoder positions. See section 3.3.2.1 on page 38.

The following sections describe the digital I/O in more detail.

3.3.1 Digital Inputs - X13

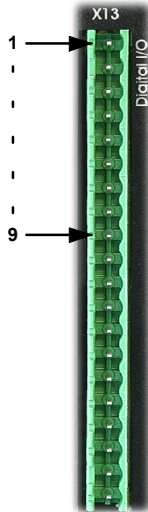

Location	Connector X13		
	Pin	Name	Mint keyword
	1	Drive Enable	-
	2	DIN10	IN. 10
	3	DIN11	IN. 11
	4	DIN12	IN. 12
	5	DIN13	IN. 13
	6	DIN14	IN. 14
	7	DIN15	IN. 15
	8	DIN16	IN. 16
	9	DIN17	IN. 17
Description	Eight general purpose optically isolated AC digital inputs (DIN10 to DIN17). One committed drive enable input (Drive Enable).		

The digital inputs DIN10 - DIN17 can be read individually using the associated Mint `IN` keyword (for example `IN. 10`) and can be configured for any number of user definable functions. These inputs are sampled every 15.36ms. If a faster response is required, DIN0~DIN9 on connector X5 can be used.

Each of the AC optically isolated digital inputs has one side connected internally via a current limiting resistor to the signal on pin 12, CREF. The other side appears as a separate pin on connector X13, for use by the end user.

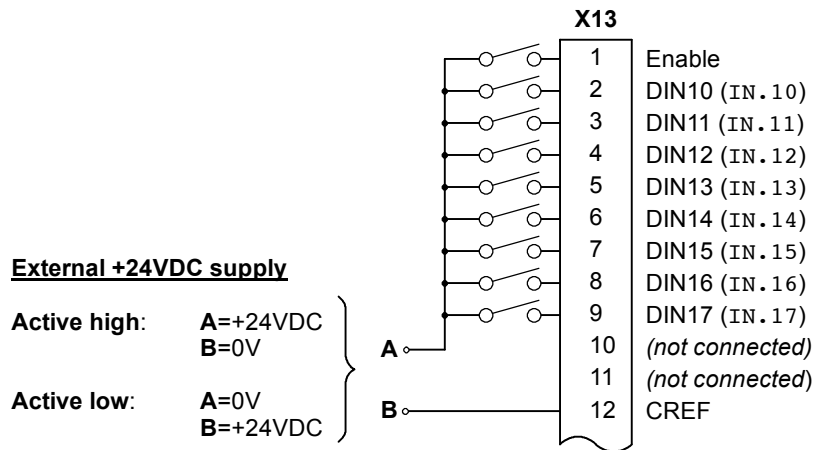

Figure 15 - X13 Digital inputs

Pin 12 (CREF) controls the sense of all the digital inputs (X13 pins 1 to 9) and should be permanently wired, dependent on the user requirements, as described below:

Active high: connect +24VDC to pin1 and 0V to pin 12.

The digital inputs will be active when a voltage of +24VDC ($\pm 20\%$) is applied to them and will sink a maximum of 20mA.

Active low: connect +24VDC to pin12 and 0V to pin 1.

The digital inputs will be active when grounded and will source a maximum of 20mA.

The +24VDC supply mentioned above is from an externally generated 24VDC supply which should have a current capability of at least 3A to fulfill all the current requirements of the above loads.

The sense of the inputs can also be controlled individually in Mint using the keyword `INPUTACTIVELEVEL`. See also section 2.6 on page 26.

3.3.1.1 Thermal switch connection

It is recommended to wire the motor's thermal switch, via a relay, to an input on connector X13. Using suitable code, this provides a way for the Mint program to respond to motor overtemperature conditions. A typical circuit, using DIN11 as the input, is shown below.

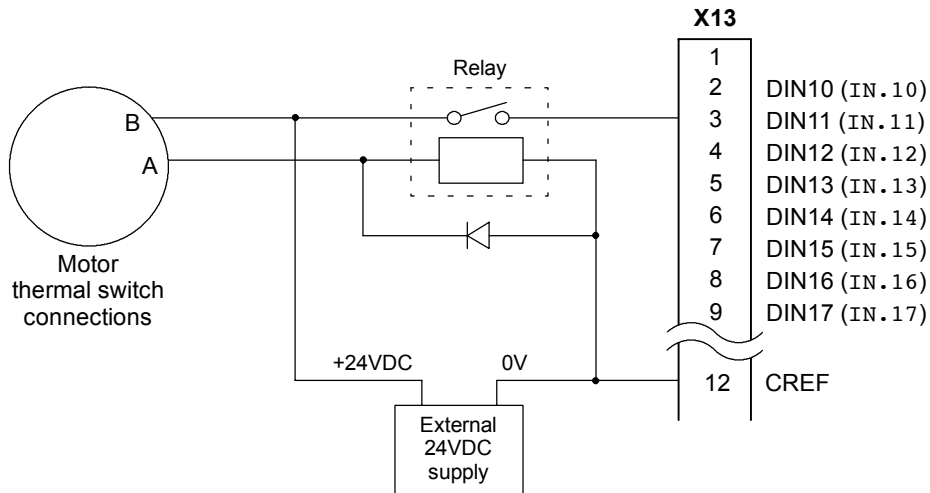

Figure 16 - Motor thermal switch circuit

3.3.2 Digital Inputs - X5



Location	Connector X5		
	Pin	Name	Mint keyword
	1	DIN0	IN.0
	2	DIN2	IN.2
	3	DIN4	IN.4
	4	DIN6	IN.6
	5	DIN8	IN.8
	14	DIN1	IN.1
	15	DIN3	IN.3
	16	DIN5	IN.5
	17	DIN7	IN.7
	18	DIN9	IN.9
Description	Ten general purpose optically isolated AC digital inputs (DIN0 to DIN9).		

The digital inputs DIN0 - DIN9 can be read individually using the associated Mint `IN.x` keyword (for example `IN.0`) and can be configured for any number of user definable functions. These inputs are sampled every servo loop (0.5ms to 2ms).

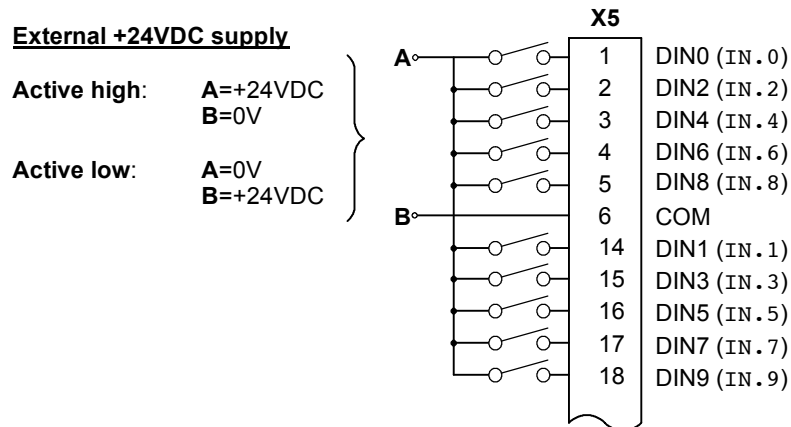

Figure 17 - X5 Digital inputs

These inputs are isolated and share a single common line (COM). The entire input bank may be configured for use in PNP mode (sinking current, where current flows in to the inputs) by connecting COM to the negative rail of the externally generated power source. Alternatively the entire input bank may be configured for use in NPN mode (current flows out of the inputs) sourcing current by connecting COM to the positive rail of the externally generated power source.

The use of screened/shielded cable with the screen terminated on the D-shell is highly recommended and will improve the inputs' immunity to interference.

COM (pin 6) controls the sense of all the X5 digital inputs and should be permanently wired, dependent on the user requirements, as described below:

Active high: Connect pin 6 to 0V.

The digital inputs will be active when a voltage of +24VDC (+10VDC to +30VDC) is applied to them and will sink a maximum of 20mA.

Active low: Connect pin 6 to +24VDC.

The digital inputs will be active when grounded (less than 2VDC) and will source a maximum of 20mA. (To eliminate any possible errors, designs should ideally provide a "grounded" voltage of less than 1V).

The +24VDC supply mentioned above is from an externally generated 24VDC supply with an adequate current capability to fulfill all the current requirements of the above loads. The sense of the inputs can also be controlled individually in Mint using the keyword `INPUTACTIVELEVEL`.

The inputs are compatible with mechanical switches or open-collector drivers. They are not, however, compatible with external push-pull drivers unless an external diode is fitted, which effectively converts a push-pull driver into an open collector driver.

There is a hardware propagation delay of 10µs or less between applying an external voltage and the switch becoming active (ON). Similarly, there is a delay of 50µs or less for the device to switch OFF when removing an external voltage.

3.3.2.1 Special functions on inputs DIN0 and DIN2

DIN0 and DIN2 can be configured using the `FASTAUXSELECT` keyword to perform special functions:

Input	Function
DIN0	Configurable as the fast interrupt (FASTIN) hardware position capture input. The position of the axis is captured in real time and can be read using the Mint keyword <code>FASTPOS</code> . DIN0 can also be configured to capture the auxiliary encoder input as well as the axis position input. Fitted with a Schmitt trigger device.
DIN2	Similar to DIN0, but captures the master or auxiliary encoder input which can be read using the Mint <code>FASTAUXENCODER</code> keyword. Fitted with a Schmitt Trigger device.

3.3.2.2 Breakout board

Connector X5 can also be connected to an I/O supporting break-out board (giving screw-terminal type connections and local filtering). The Baldor catalog number for this item is OPT017-501. See page 48.

3.3.3 Digital Outputs - X13

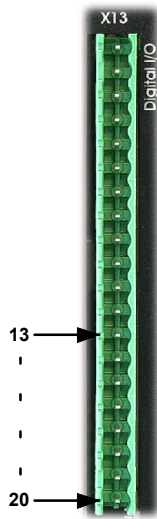

Location	Connector X13		
	Pin	Name	Mint keyword
	13	DOUT5-	OUT . 5
	14	DOUT5+	OUT . 5
	15	DOUT6-	OUT . 6
	16	DOUT6+	OUT . 6
	17	DOUT7-	OUT . 7
	18	DOUT7+	OUT . 7
	19	DOUT8-	OUT . 8
	20	DOUT8+	OUT . 8
Description	Four general purpose optically isolated digital outputs (DOUT5 to DOUT8).		

Each optically isolated output may be configured for either sinking or sourcing current up to a maximum of 50mA on each output. The maximum saturated voltage across any of these outputs when active is 1.0VDC, so they can be used as TTL compatible outputs. These outputs can have a mixed configuration, with some sinking current while others source current. However, if the outputs are used to directly drive a relay, a suitably rated flyback diode must be fitted across the relay coil, observing the correct polarity. This is to ensure that an output is protected from the back-EMF generated from the coil when it is de-energized. The outputs are updated every 30.72ms and can be written to directly using the Mint keyword `OUT` (for example `OUT . 5`). If a faster response is required, `DOUT0~DOUT4` on connector X5 can be used.

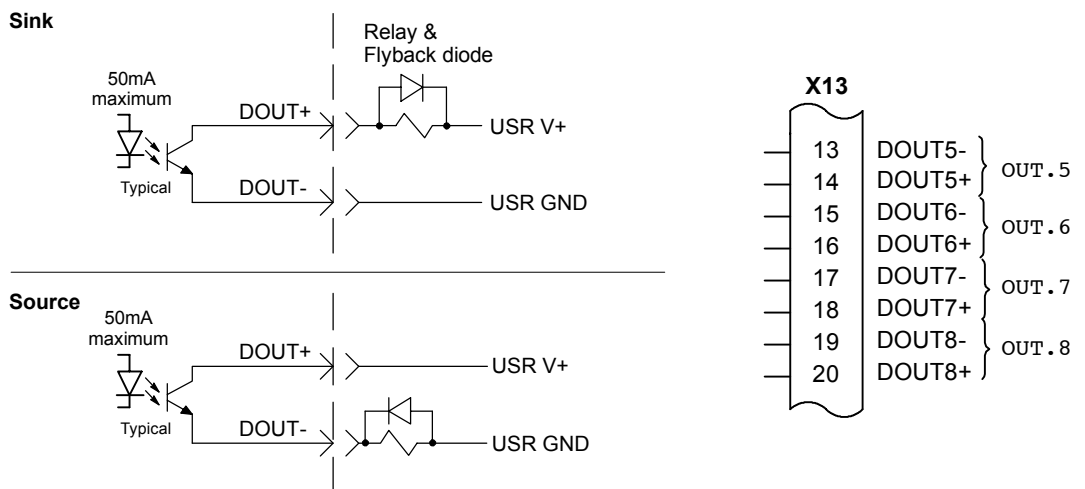
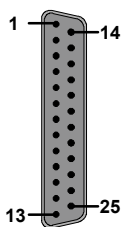
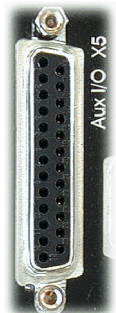

Figure 18 - X13 Digital output circuit

3.3.4 Digital Outputs - X5



Location	Connector X5		
	Pin	Name	Mint keyword
	10	DOUT4	OUT . 4
	11	DOUT2	OUT . 2
	12	DOUT0	OUT . 0
	23	DOUT3	OUT . 3
	24	DOUT1	OUT . 1
Description	Five general purpose optically isolated digital outputs (DOUT0 to DOUT4).		

These general purpose optically isolated outputs can only be used to source current from the USR V+ rail (pin 25). The output current source passes through the load to USR GND (pin 13). The outputs are updated immediately and can be written to directly using the Mint keyword `OUT` (for example `OUT . 4`).

Note: The outputs have different current ratings!

DOUT0 is a high current output, rated at a maximum continuous current of 1A. DOUT1~DOUT3 are lower current outputs, rated at a maximum continuous current of 250mA on each output. There is no minimum current load requirement for DOUT0~DOUT4.

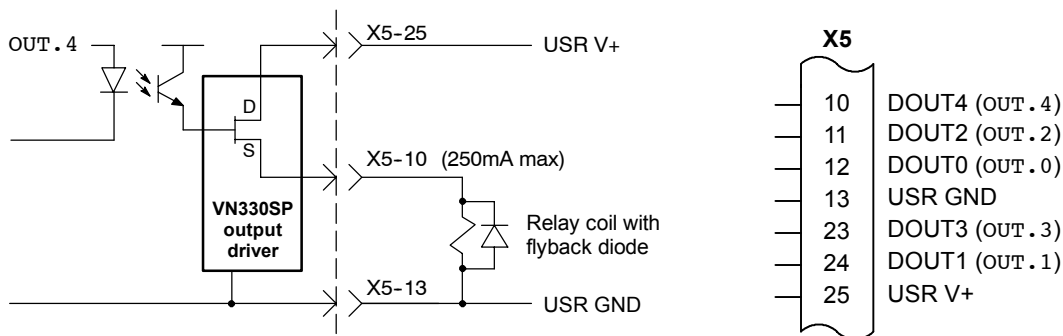

Figure 19 - X5 Digital output circuit

These MOSFET type outputs are driven from ST VN330SP devices and have a maximum ON resistance of 0.4Ω. There are protection features built into each of the outputs. Under voltage sensing means that when a USR V+ voltage of less than 10V is applied, the output will become inactive. Thermal protection, for short circuit and over dissipation, also causes the output to become inactive. If the combined current of all the X5 outputs exceeds 5A, there is the possibility of blowing an internal SMD fuse, which is not easily replaceable and is non-serviceable. If a hardware fault is suspected on these outputs, the condition can be checked (by the user's program) using the Mint keyword `MISCERROR`. If the outputs are used to directly drive a relay or an inductive load, a suitably rated flyback diode must be fitted across the relay coil, observing the correct polarity. This is to ensure that an output is protected from the back-EMF generated from the coil when it is de-energized.

3.4 Other I/O

3.4.1 Simulated encoder output - X3



Location	Connector X3	
	Pin	Name
	1	CHA+
	2	CHB+
	3	CHZ+
	4	(not connected)
	5	DGND
	6	CHA-
	7	CHB-
	8	CHZ-
	9	(not connected)
Description	Simulated encoder output on a 9-pin female D-type connector	

This output can be used for master slave situations where the axis movement can be transmitted to another controller or MintDrive. It is recommended that this output only drives one output circuit load. Driving multiple loads is not recommended. The encoder outputs are differential and conform to the RS422 electrical specification. Shielded twisted pair cable is recommended.

If a resolver is fitted to the MintDrive, the output resolution is 1024 ppr (pulses per revolution). This is equivalent to a 1024 line encoder, giving 4096 quadrature counts per rev. The simulated encoder also supports an index or marker pulse.

If the MintDrive has the encoder feedback option, X3 duplicates the encoder signals entering X2.



CAUTION:

Using connectors X3 and X6, multiple MintDrives can be 'daisy-chained' together. However, if another Mint based controller such as a NextMoveBX is to be connected, a special cable must be built, as shown below:

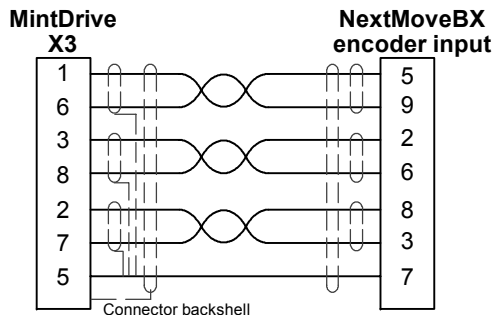
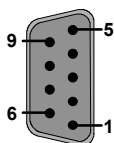
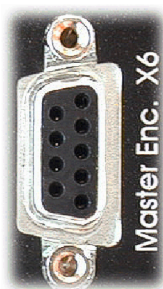

Figure 20 - MintDrive encoder output to other Mint controller encoder input

3.4.2 Master (auxiliary) encoder input - X6



Location	Connector X6	
	Pin	Name
	1	CHA+
	2	CHB+
	3	CHZ+
	4	(not connected)
	5	DGND
	6	CHA-
	7	CHB-
	8	CHZ-
	9	+5V
Description	Optically isolated encoder input on a 9-pin female D-type connector	

The MintDrive provides an auxiliary (master or handwheel) encoder input which allows following of a master encoder. An interface for a three channel, incremental encoder (CHA, CHB, CHZ) is provided. The input receiver circuit allows only encoders with differential line drivers (RS422) to be used. Single-ended operation is not supported. The interface also provides an isolated 5V supply for the encoder electronics, capable of driving up to 100mA. These inputs are sampled every 0.5, 1 or 2ms.

CAUTION: The auxiliary encoder input does not conform to the standard on other Mint based controllers such as NextMove.

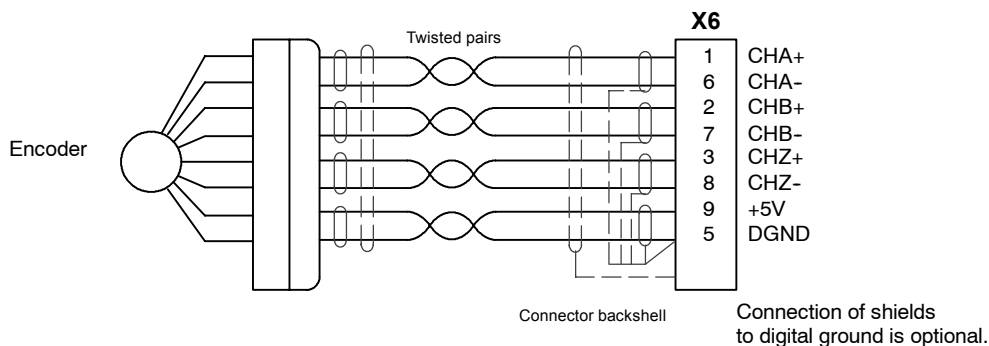

Figure 21 - Differential encoder connections

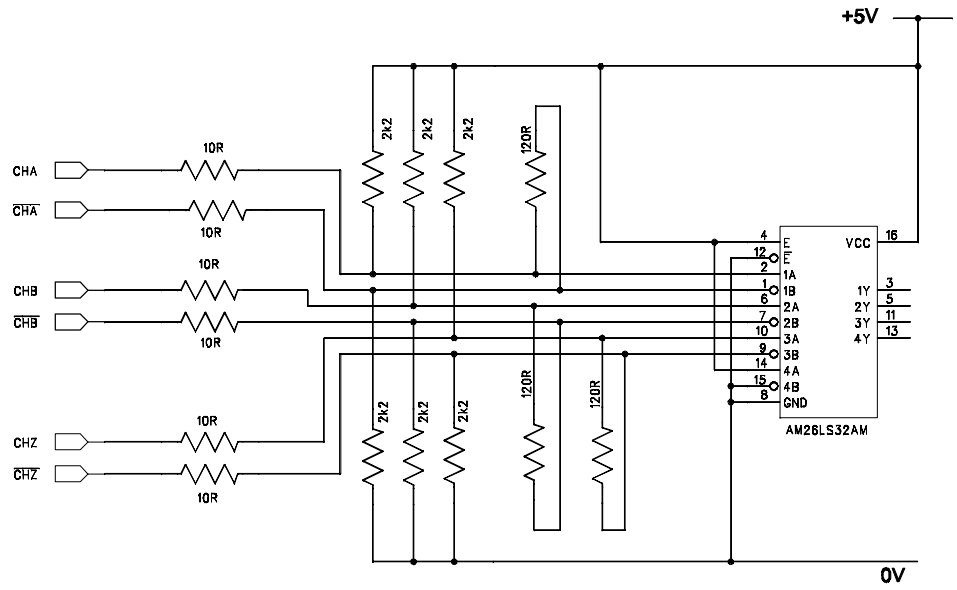
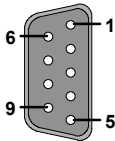

Figure 22 - Auxiliary encoder circuit

3.4.3 Serial port - X7



Location	Connector X7		
	Pin	RS232 Name	RS485 / RS422 name
	1	-	RX+ (input)
	2	RXD	-
	3	TXD	-
	4	-	TX+ (output)
	5	0V GND	0V GND
	6	-	RX- (input)
	7	RTS	-
	8	CTS	-
	9	-	TX- (output)
Description	RS232 and RS485 / RS422 connections on a single 9-pin female D-type connector		

X7 is a 9-pin male D-type connector, for the single MintDrive serial port. The four-wire RS485 connections are also available on the this connector. See pages 45 and 46. This port is configurable as either RS232 or RS485 / RS422 or both. Both X7 options are fully ESD protected to IEC 1000-4-2 (15kV). Neither is isolated.

3.4.4 Using RS232 cable



CAUTION: The serial connector on the MintDrive (X7) supports two serial channels, one RS232 and one RS485 / RS422. The serial cable with catalog number CBL001-501 must NOT be used with the MintDrive as this may result in damage to the unit. Please use serial cable CBL023-501 or see this section for wiring details.

The MintDrive has a full-duplex RS232 serial port with the following default configuration:

- 57.6Kbaud
- 1 start bit
- 8 data bits
- 1 stop bit
- No parity
- Hardware handshaking lines (RS232) RTS and CTS must be connected

The MintDrive will transmit a line feed/carriage return (<LF><CR>) combination but only expects a carriage return (<CR>) from the host terminal. The RS232 connections are brought out onto a 9-pin male D-type connector (an identical pin configuration as a standard male 9-pin D-type connector, but RS485 / RS422 signals are also taken to the unused pins). The RS232 port is configured as a DTE (Data Terminal Equipment) unit so it is possible to operate the MintDrive with any DCE (Data Communications Equipment) or DTE equipment. Both the output and input circuitry are single ended and operate between $\pm 12V$. The port is capable of operation at up to 57.6Kbaud.

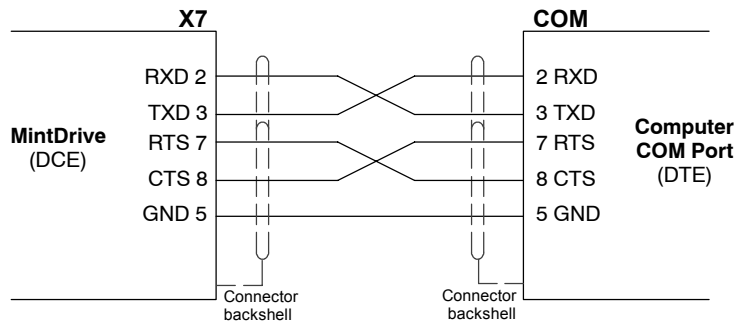

Figure 23 - RS232 serial port connections

3.4.5 Multidrop using RS485 / RS422 cable

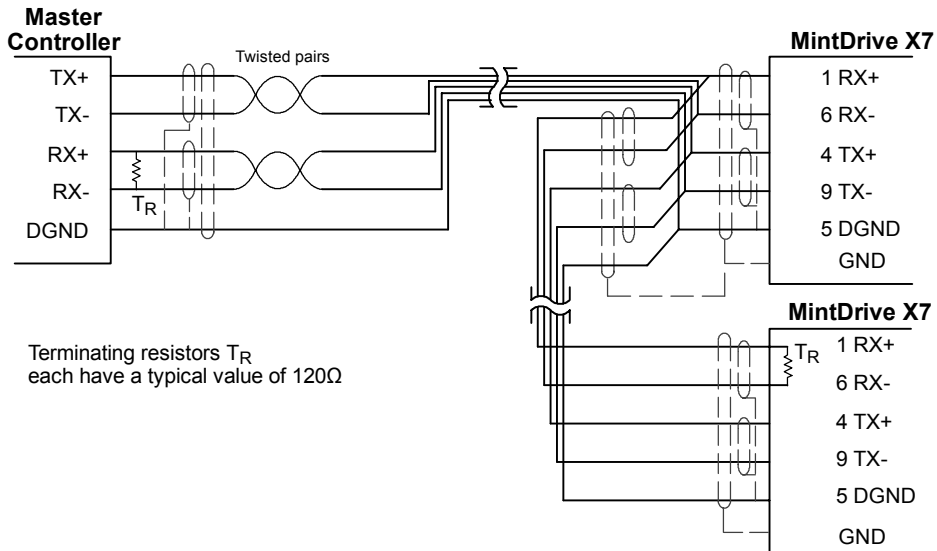

Figure 24 - 4-wire RS485 multi-drop connections

ON ←



The MintDrive at the furthest end of the network from the transmitter should have its RS485 DIP switch (located on the front panel of the MintDrive) set to the 'On' position. This will connect a termination resistor, used to match the impedance of the load to the impedance of the transmission line (cable).

Each TX/RX network requires a termination resistor at the final RX connection, but intermediate devices must not be fitted with termination resistors. (An exception to this rule is where repeaters are being used which may correctly contain termination resistors).

Unmatched impedance causes the transmitted signal to not be fully absorbed by the load. This causes a portion of the signal to be reflected back into the transmission line (noise). If the *Source* impedance, *Transmission Line* impedance, and *Load* impedance are all equal, these reflections (noise) are eliminated. Termination does increase load current and sometimes changes the bias requirements and increases the complexity of the system.

3.4.6 Connecting Baldor HMI Operator Panels

Baldor HMI Operator Panels use a 15-pin male D-type connector (marked PLC PORT), but the MintDrive connector X7 is a 9-pin D-type connector. If you do not require hardware handshaking then the following connections should be made:

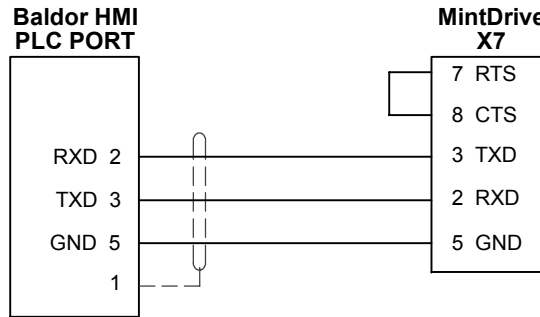

Figure 25 - Cable wiring if hardware handshaking is *not* required

If hardware handshaking is required then the following connections should be made:

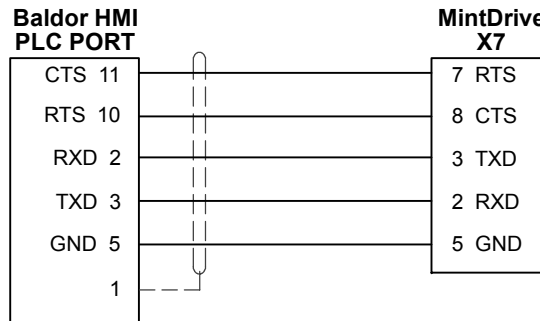

Figure 26 - Cable wiring if hardware handshaking is *is* required

3.4.7 Optional breakout board for connector X5

An optional screw connection fitting is available should you wish to purchase a break-out board. The break-out board, often referred to as a 'card', mounts on a 35mm DIN rail. The board has two-part screw terminals for all of the digital inputs, digital outputs, analog inputs and analog outputs of the MintDrive's X5 connector, together with indicator LEDs.

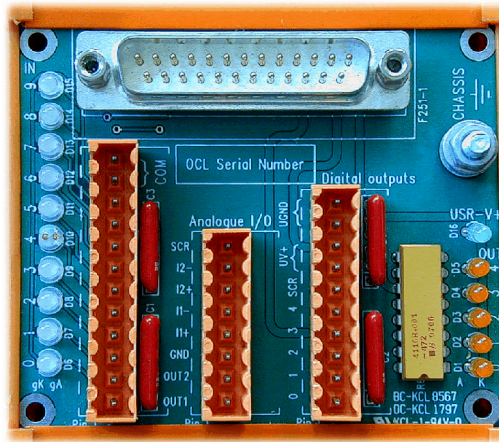

Figure 27 - Optional breakout board

The catalog number for the breakout board is OPT017-501. A 2m (6ft) cable is available with correctly shielded cables (catalog number CBL022-501).

3.4.8 CAN peripherals

If you wish to make connections to a CAN network see Appendix B, before continuing with section 4.

This completes the input/output wiring.

You should read the following sections in sequence before attempting to start the MintDrive.

4.1 Outline

Before powering the MintDrive you will need to connect the PC to the MintDrive using a serial cable and install the supplied software on the PC. The software provided includes a number of applications and utilities to allow you to configure, tune and program the MintDrive. If you do not have experience of software installation or Windows applications you will need to seek further assistance for this stage of the installation. Please see the hardware section on page 5 to check that you have a suitable PC.

4.1.1 Connecting the MintDrive to the PC

Connect the serial cable between the PC serial port (often labeled as "COM") to the MintDrive connector X7 (RS232/RS485).



CAUTION:

The serial connector on the MintDrive (X7) supports two serial channels, one RS232 and one RS485. The serial cable with catalog number CBL001-501 must not be used with the MintDrive as this may result in damage to the unit. Please use serial cable CBL023-501 or see pages 44 and 45. If this is the first time you are installing a MintDrive then it is strongly recommended that you use RS232 to get started and use RS485 later.

4.1.2 Installing the software

The CDROM containing the software can be found inside the rear cover of this manual or separately within the packaging.

1. Insert the CDROM into the drive.
2. After a few seconds the setup wizard should start automatically. If the setup wizard does not appear, select **Run...** from the Windows **Start** menu and type

d:\setup

where d is the drive letter of the CD-ROM device.

Follow the on-screen instructions to install the Mint Configuration Tool and Mint Workbench. The set-up Wizard will copy the files to appropriate folders on the hard drive. The default directory is C:\Mint v4, although this can be changed during setup.

4.1.3 Starting the MintDrive

If you have followed the instructions in the previous sections, you should now have connected all the power sources, your choice of I/O peripherals, CAN network connections (if required) and the serial cable linking the PC with the MintDrive. It is advisable to check all of these connections before proceeding.

You are now ready to power the MintDrive:

1. Turn on the mains supply.
2. If your MintDrive has an external 24VDC logic supply, turn this on.

The MintDrive's Ready LED should be orange-green.

Note: If the Ready LED is red after powering the unit, turn off the power immediately.

This indicates that the drive has detected a fault - see section 7.1.3 on page 87.

If this is a severe error condition such as under or over-voltage the unit could be damaged.

Re-check the wiring in accordance with section 2.3 on page 10.

Power the unit again; if the Ready LED is still red then see the troubleshooting guide starting on page 85.

3. After a couple of seconds the Ready LED should turn green and the Monitor LED should display a minus sign (-). If no LEDs are lit then re-check the power supply connections. Both CAN LEDs should be green, but if your MintDrive is configured as node 1 and no CANopen devices are attached, the CAN1 LED will be red.

4.2 Mint Configuration Tool Startup Wizard - coarse tuning

Each type of motor and drive combination has a slightly different response. Before the MintDrive can be used to control the motor accurately, the MintDrive must be “tuned”. This is the process where the MintDrive powers the motor using a pre-defined set of moves. By monitoring the feedback from the motor’s resolver or encoder, the MintDrive can make small adjustments to the way it controls the motor. This information can then be stored in a configuration file, together with other information.

The Mint Configuration Tool (MCT) provides a simple way to tune the MintDrive and create the configuration file, so this is the first application that should be used.

1. On the Windows **Start** menu, select **Programs, Mint v4, Mint Configuration Tool**.

The MCT will start and the Startup Wizard Introduction window will be shown.

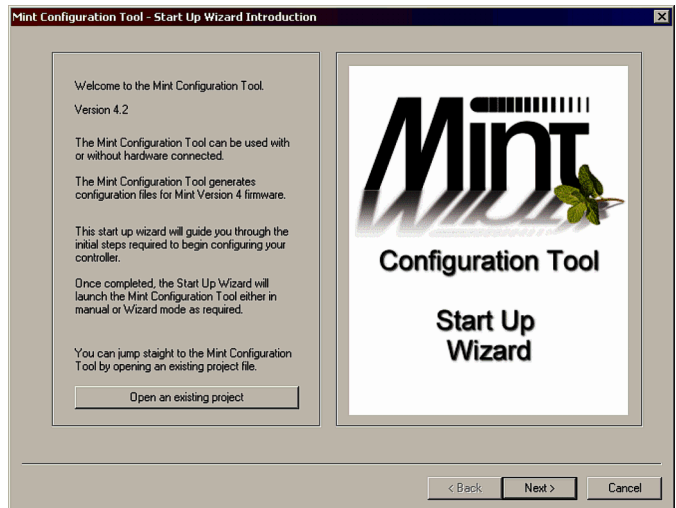

2. Click **Next >**.

If you wish to enter some details about the configuration, click in the appropriate text boxes and enter the information. You can leave any or all of the boxes blank if you wish.

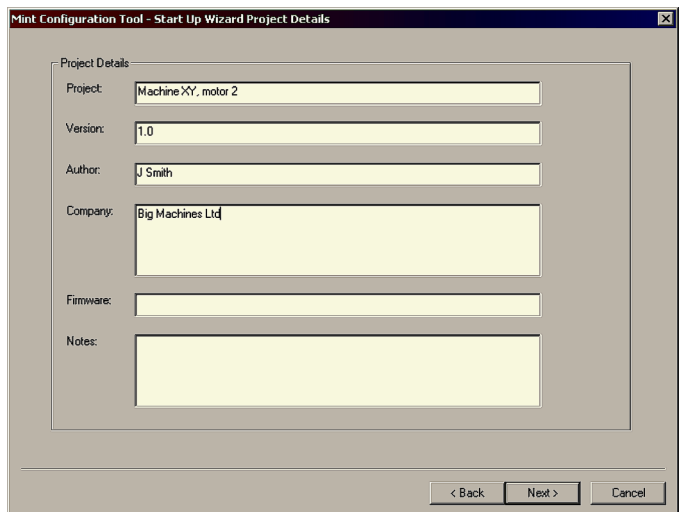

- Click **Next >** .
MCT will search the serial ports on the PC until the MintDrive is detected.
If the MintDrive is not found, check the serial connection and click **Rescan**.

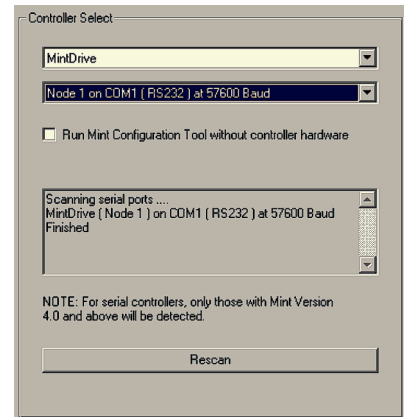

- Click **Next >** .
Check that **Axis-0** is highlighted.

Note: If you need to change the configuration, click on the highlighted line to display the Axis Configuration dialog.

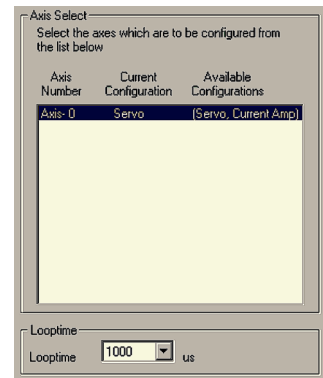

- Click **Next >** .
The Wizard Axes Scale Parameters window allows you to setup a scaling factor for later use when controlling the MintDrive.

Select **Counts per revolution** in the Scale to box.
This means that references to movement can be expressed in revolutions, rather than encoder counts.

Note: Mint defines all positional and speed related motion keywords in terms of encoder quadrature counts (for servo motors) or steps for stepper motors. The scale factor allows the system to be scaled to your own units (called user units) to suit your application.
With a resolver or 1024 line encoder, a scale factor of 4096 gives a user unit of revolutions.

Note: Even though you may have a MintDrive with the resolver option fitted, the input from the resolver is converted into simulated encoder counts inside the MintDrive.

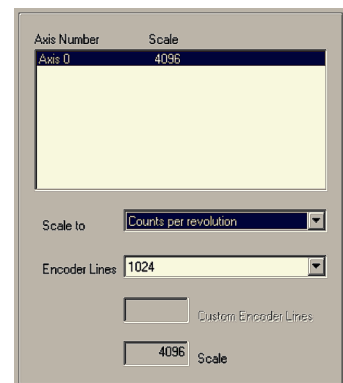

6. Click **Next >** .

The Axis Configuration Test Select frame provides two options.

Click **PERFORM AXES CONFIGURATION TESTS**.

The axis configuration tests allows MCT to tune the MintDrive for use with the attached motor.

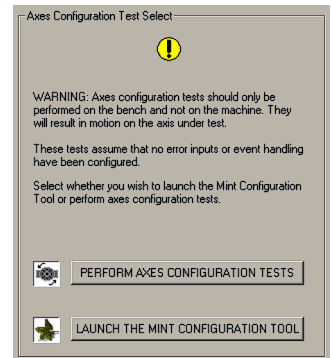

7. Using the drop-down boxes, select the *exact* motor type. This information can be found stamped into the label attached to the motor.

Important Note:

The following axis configuration tests must be performed with the motor mechanically disconnected from other machinery. The tests will cause movement of the motor, so ensure that it is safe for the motor to operate.

If it is safe for the motor to rotate, click **Coarse Tune Motor Parameters** .

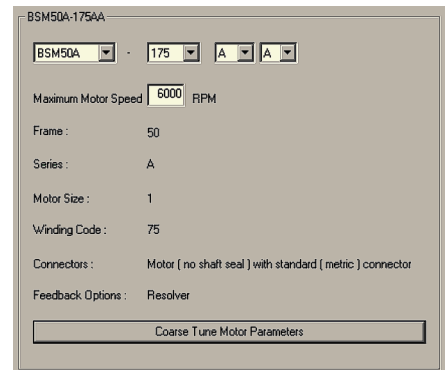

Click **OK** to confirm that you wish to begin the tests. MCT will begin the motor tests.

8. For the final test, the load should be connected to the motor.

Ensure that it is safe for the motor to operate when connected to the load.

If it is safe for the motor to operate, click **OK**. MCT will perform the final test.

9. Click **Next >** to continue with the tuning process.

Note: If an error occurs during any of the tests, an error number will appear on the error button at the top of the window:

Error: 512

Click the button to see details of the error. When you have fixed the error, click **Clear Errors** and then **Coarse Tune Motor Parameters** to restart the tests.

4.3 MCT Startup Wizard - fine-tuning

In the previous section, the motor response was 'coarse tuned'. The following sections describe how to fine tune the motor response. If you are familiar with closed loop servo control theory then you may wish to proceed straight to section 4.3.2. If not, the following section provides an introduction to the various factors involved, with simple analogies shown with *[italics]*.

4.3.1 An introduction to closed loop control

When a demand is made to move the axis position, the MintDrive control software translates this into motor currents. An encoder or resolver is used to measure the motor position, and every 1ms* the MintDrive compares the demanded and measured positions and calculates the demand needed for the motor to minimize the difference, the **following error**.

This system of constant measurement and correction is known as closed loop control.

[For the analogy, imagine you are in your car waiting at an intersection. You are going to go straight on when the lights change, just like the car standing next to you which is called Demand. You're not going to race Demand though - your job as the controller (MintDrive) is to stay exactly level with Demand, looking out of the window to measure your position].

The main term that the MintDrive uses to correct the error is called **Proportional gain (KPROP)**.

A very simple proportional controller would simply multiply the amount of error by the Proportional gain and apply the result to the motor *[the further Demand gets ahead or behind you, the more you press or release the gas pedal]*.

If the Proportional gain is set too high overshoot will occur, resulting in the motor vibrating back and forth around the desired position before it settles *[you press the gas pedal so hard you go right past Demand. To try and stay level you ease off the gas, but end up falling behind a little. You keep repeating this and after a few tries you end up level with Demand, travelling at a steady speed. This is what you wanted to do but it has taken you a long time]*.

If the Proportional gain is increased still further, the system becomes unstable *[you keep pressing and then letting off the gas pedal so hard you never travel at a steady speed]*.

To reduce the onset of instability, a term called **Velocity Feedback gain (KVEL)** is used. This resists rapid movement of the motor and allows the Proportional gain to be set higher before vibration starts. Another term called **Derivative gain (KDERIV)** can also be used to give a similar effect.

With Proportional gain and Velocity Feedback gain (or Derivative gain) it is possible for a motor to come to a stop with a small following error *[Demand stopped so you stopped too, but not quite level]*. The MintDrive tries to correct the error, but because the error is so small the amount of torque demanded might not be enough to overcome friction.

This problem is overcome by using a term called **Integral gain (KINT)**. This sums the error over time, so that the motor torque is gradually increased until the positional error is reduced to zero *[like a person gradually pushing harder and harder on your car until they've pushed it level with Demand]*.

However, if there is large load on the motor (it is supporting a heavy suspended weight for example), it is possible for the output to increase to 100% demand. This effect can be limited using the `KINTLIMIT` keyword which limits the effect of KINT to a given percentage of the demand output. Another keyword called `KINTMODE` can even turn off integral action when it's not needed.

The final term to consider is **Velocity Feed forward (KVELFF)** which can be used to increase the response and reduce the following error, especially with velocity controlled servos.

In summary, the following rules can be used as a guide:

- **KPROP:** Increasing KPROP will speed up the response and reduce the effect of disturbances and load variations. The side effect of increasing KPROP is that it also increases the overshoot, and if set too high it will cause the system to become unstable. The aim is to set the Proportional gain as high as possible without getting overshoot, instability or hunting on an encoder edge when stationary (the motor will buzz).
- **KVEL:** This gain has a damping effect, and can be increased to reduce any overshoot. If KVEL becomes too large it will amplify any noise on the velocity measurement and introduce oscillations.
- **KINT:** This gain has a de-stabilizing effect, but a small amount can be used to reduce any steady state errors. By default, KINTMODE is set so that the KINT term is ignored.
- **KINTLIMIT:** The integration limit determines the maximum value of the effect of integral action. This is specified as a percentage of the full scale demand.
- **KVELFF:** This is a feed forward term and as such has a different effect on the servo system than the previous gains. KVELFF is outside the closed loop and therefore does not have an effect on system stability. This gain allows a faster response to demand speed changes with lower following errors, for example you would increase KVELFF to reduce the following error during the slew section of a trapezoidal move. The trapezoidal test move can be used to fine-tune this gain.
- **KDERIV:** This gain has a damping effect. The Derivative action has the same effect as the velocity feedback if the velocity feedback and feedforward terms are equal, but scaled by a factor of 16.

In systems where precise positioning accuracy is required, it is often necessary to position within one encoder count. Proportional gain, KPROP, is not normally able to achieve this because a very small following error will only produce a small demand for the amplifier which may not be enough to overcome mechanical friction (this is particularly so for current controlled systems). This error can be overcome by applying some Integral gain.

The Integral gain, KINT, works by accumulating following error over time to produce a demand sufficient to move the motor into the zero following error position. KINT can therefore also overcome errors caused by gravitational effects, such as vertically moving linear tables, where with current controlled drives a non-zero demand output is required to achieve zero following error.

For further details see Appendix A.

* The 1ms sampling interval can be changed using the `LOOPTIME` keyword.

4.3.2 Fine-tuning the speed loop

Before selecting the servo (position) loop gains, the speed loop gains might need to be fine tuned.

Note: MCT will have created starting values for the speed loop gains, so if you are not sure which values to adjust, you can go straight to section 4.3.3 on page 57.

If you wish to change any of the speed loop gains:

1. Click the Speed Loop Tuning tab 
2. The Speed Loop Tuning Parameters frame shows the values of the terms.

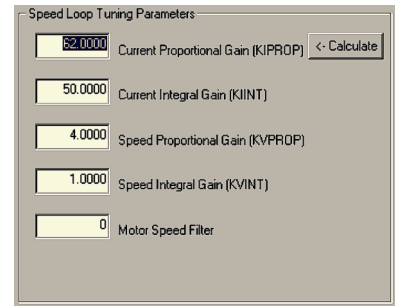

3. MCT will have calculated suitable values during the coarse tuning tests. However, in some systems you may achieve better results using the theoretical value for KIPROP. To do this, click **<-Calculate**. The Calculate Current Proportional Gain dialog box will appear.

Click **Use this value** to use the theoretical value.

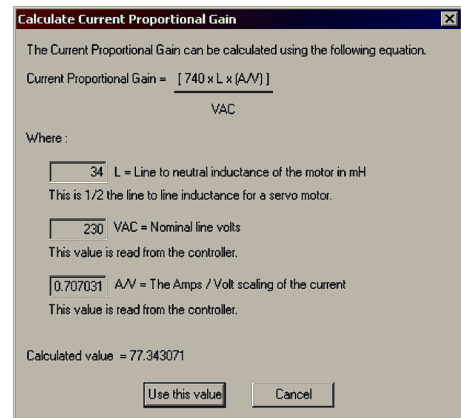

The following information should be considered if you change any of the speed loop parameters.

The value for **Current Integral gain** (KIINT) is preset to 50Hz. This setting is suitable for almost every system and should not need be changed.

The value for **Speed Proportional gain** (KVPROP) is set to a default value of 4. This gain may be increased or decreased to suit the application. Increasing KVPROP will result in a faster response, but excessive values will cause overshoot and oscillation.

The value for **Speed Integral gain** (KVINT) is set to a default value of 1 and should not be adjusted unless you are an experienced user.

The value for **Speed Differential gain** (KVDIFF) has no effect on the MintDrive.

4.3.3 Fine-tuning the position loop

The following tuning methods involve adjusting the servo loop terms KVELFF, KPROP, KVEL and KDERIV, which all have a default value of zero.

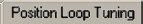
1. Click the Position Loop Tuning tab 

2. The Tuning Parameters frame shows the values of the terms.

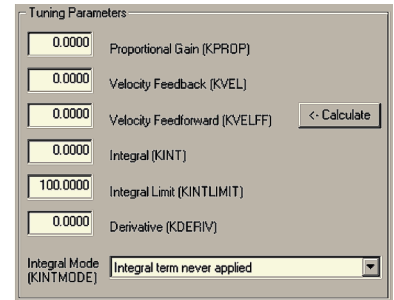

3. The first value to enter is KVELFF. To do this, click **<-Calculate**. The Calculate Velocity Feedforward Gain dialog box will appear.

Click **Use this value** to enter the value.

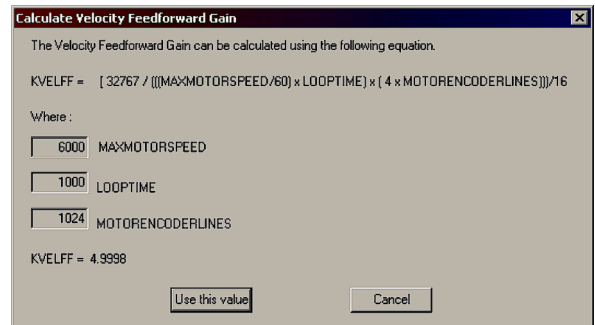

4. In the Shape Parameters frame, ensure the Move Type box is set to **Step**.

Click in the **Size (uu)** box and enter a value of 0.2.

Note: The term “uu” means user units. Previously, in the Wizard Axes Scale Parameters window, you setup a scaling factor of 4096 - equivalent to 1 count per revolution - so the the user unit is now revolutions. If you selected a different scaling factor the value of 0.2 might not be suitable.

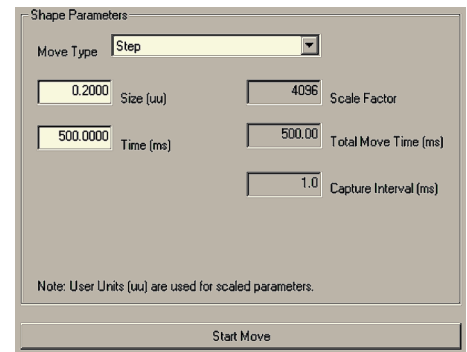

5. Click **Start Move** .



In the dialog box that appears, click **GO** .

The motor will now attempt to rotate 0.2 revolutions. MCT will upload the recorded (captured) data from the MintDrive and the Tuning Graph tab will be shown. Below the graph, make sure that only the Actual Position and Demand Position boxes are checked.

Note:

The graph that you see on your system will not look exactly the same as the graph shown below! Remember that each motor has a slightly different response.

With only KVELFF defined, you will get very little response.

The Proportional gain term, KPROP, should be used to overcome the large following error...

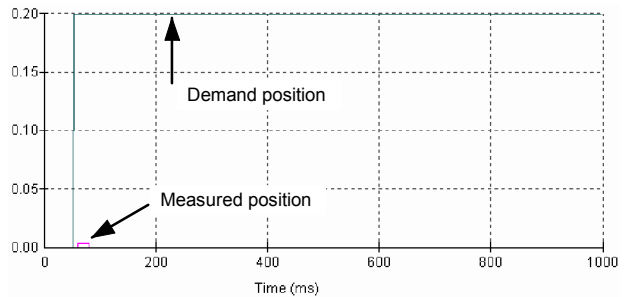

6. Click the Position Loop Tuning tab, click the KPROP box and enter a small starting value, for example 1.

Click **Start Move** .



In the dialog box that appears, click **GO** .

Adding the KPROP term has improved the response, but it is still quite slow.

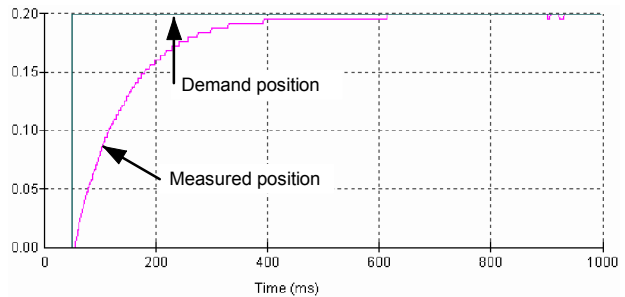

As the value of KPROP increases, the rise (response) time will decrease. For example, the plot opposite shows the effect of setting KPROP to a value of 3.

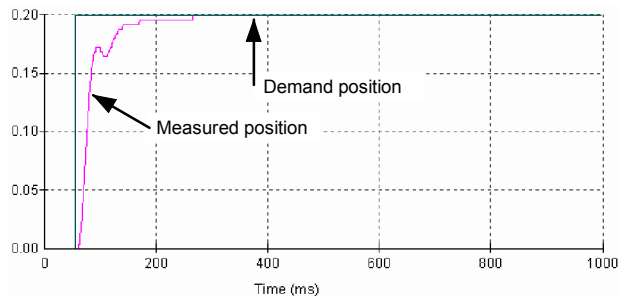

If KPROP is increased too far, overshoot or ringing will occur. The plot opposite shows the effect of setting KPROP to a value of 7.

This overshoot and/or ringing can be reduced by introducing a damping term - either KVDEL or KDERIV...

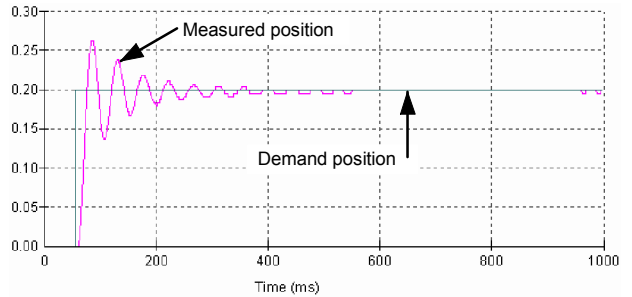

- The plot opposite shows how applying a value of 0.25 to KVDEL (with KPROP set to 4.7), causes a response with a small overshoot but which settles quickly.

The ideal response is to have a sharp (square) response with very little overshoot and no oscillations. The Step Response Statistics tab shows measured values which can be used as a further guide to tuning.

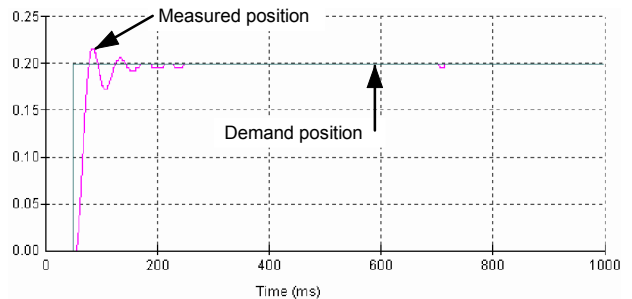

- When you have tuned the motor, click **Next >** to continue.

4.3.4 Jog test

This tab allows you to perform a jog test on the motor. This will start the motor rotating at a preset speed until it is stopped by you.

- Set the demand speed and accelerations by clicking in the bottom three boxes and typing the required values.
- Click either **Jog -ve** or **Jog +ve** to perform the test. The **Stop** button stops the movement.

The top two boxes show real-time information about the jog move.

When you have completed your tests click **Stop**, followed by **Disable Drive**.

- Click **Next >** to continue.

Jog Controls

<input type="text" value="0.00"/>	Actual Velocity (uu/s)
<input type="text" value="-79.16"/>	Actual Position (uu)
<input type="text" value="4096.00"/>	Scale Factor
<input type="text" value="72.4766"/>	Acceleration (uu/s/s)
<input type="text" value="72.4766"/>	Deceleration (uu/s/s)
<input type="text" value="4.8828"/>	Jog Speed (uu/s)
<input type="button" value="Jog -ve"/> <input type="button" value="Stop"/> <input type="button" value="Jog +ve"/>	
<input type="button" value="Disable Drive"/>	

4.3.5 Completing the Startup Wizard

The Startup Wizard is now complete. The next step is to continue with the configuration of other parameters such as inputs and outputs.

If you have not used the MCT before, it is recommended that you continue using the Wizard mode to guide you through all the stages of configuration. Manual mode is for experienced users only.

1. Click **Mint Configuration Tool in Wizard Mode** .

2. Click **Next >** to continue.



4.4 MCT Wizard - hardware configuration

The next part of the Mint Configuration Tool allows you to setup the digital inputs and outputs, perform further fine-tuning and configure many other parameters. At the bottom of the window, the help bar shows guidance about the current options.

4.4.1 Digital input configuration

The Digital Input Configuration tab allows you to define how each digital input will be triggered and, optionally, if it is to be allocated to a special function, for example the Forward Limit.



If you do not wish to configure any inputs at this stage, click **Next >** and go to section 4.4.2.

In the following example, digital input 1 (IN1) will be allocated to the forward limit input, triggered by a falling edge.

1. Drag the **Falling** icon  onto the **IN1** icon .

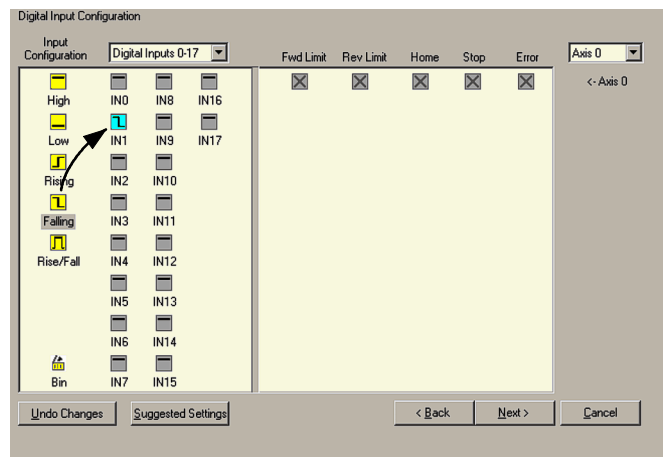
This will setup IN1 to respond to a falling edge.



2. Now drag the **IN1** icon  onto the **FWD Limit** icon .

This will setup IN1 as the Forward Limit input.

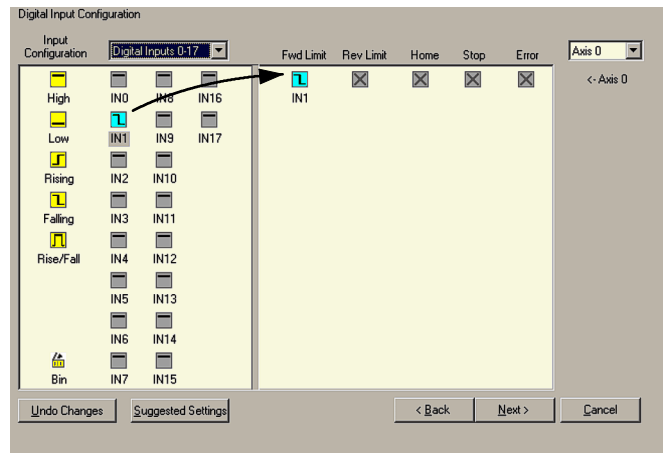

- Continue this process until you have configured all the required inputs.

Click **Next >** to continue.

The **Undo Changes** button can be used to reset all the items on the tab to their original values.

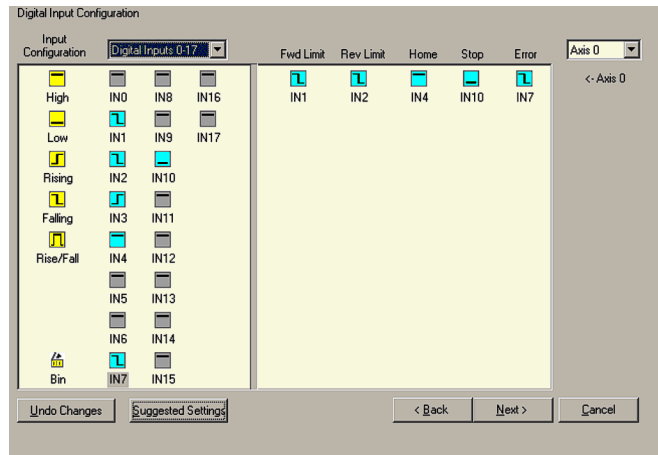

4.4.2 Digital output configuration

The Digital Output Configuration tab allows you to define how each digital output will operate and if it is to be allocated to the drive enable output. If you do not wish to configure any outputs at this stage, click **Next >** and go to section 4.4.3.

- Drag the appropriate icons to setup the digital outputs.

If you do not understand an item, click in its box and read the information shown in the help bar at the bottom of the window. The **Undo Changes** button can be used to reset all the items on the tab to their original values.

When you have finished, click **Next >** to continue.

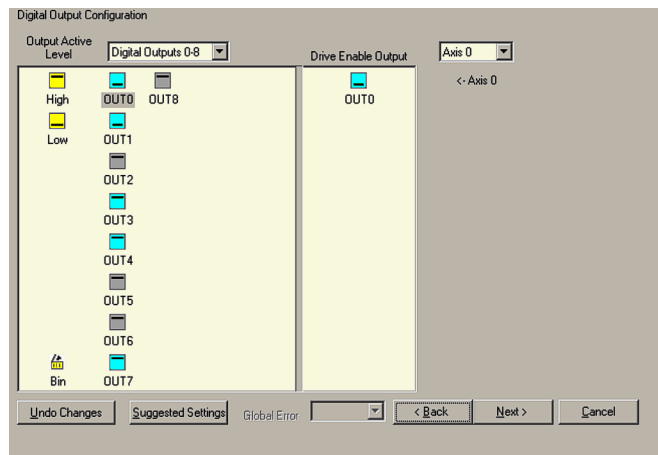

Note: The purpose of the Drive Enable Output is to provide an indication of the MintDrive's enabled status. Its use is optional and it does not have to be assigned to an output for the MintDrive to be operational.

4.4.3 Axis0 parameter configuration

The Axis0 Parameter Configuration tab allows you to setup various axis parameters. If you do not wish to make any changes, click **Next >** and go to section 4.4.4.

1. Click in the appropriate boxes and type the required values.

If you do not understand an item, click in its box and read the information shown in the help bar at the bottom of the window. The **Undo Changes** button can be used to reset all the items on the tab to their original values.

When you have finished, click **Next >** to continue.

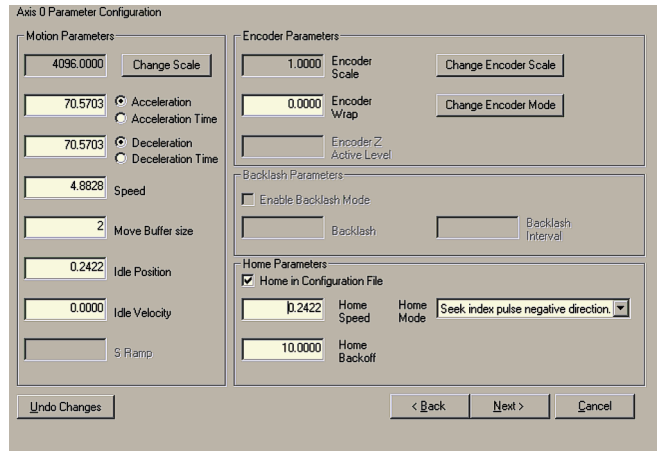

4.4.4 Axis0 error configuration

The Axis0 Error Configuration tab allows you to setup various axis error parameters. If you do not wish to make any changes, click **Next >** and go to section 4.4.5.

1. Click in the appropriate boxes and type the required values.

If you do not understand an item, click in its box and read the information shown in the help bar at the bottom of the window. The **Undo Changes** button can be used to reset all the items on the tab to their original values.

When you have finished, click **Next >** to continue.

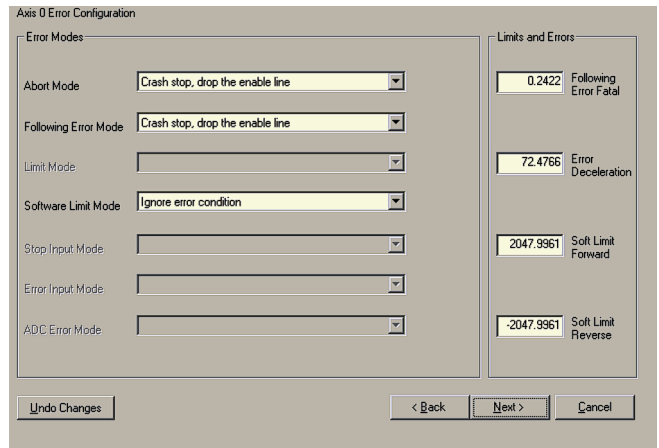

4.4.5 Axis0 tuning configuration

The Axis0 Tuning Configuration tab provides a further opportunity to make adjustments to the drive tuning. The previous values that you set will already be entered in the boxes. If you do not wish to make any changes, click **Next >** and go to section 4.4.6.

1. Click in the appropriate boxes and type the required values.

If you do not understand an item, click in its box and read the information shown in the help bar at the bottom of the window. The **Undo Changes** button can be used to reset all the items on the tab to their original values.

When you have finished, click **Next >** to continue.

Axis 0 Tuning Configuration

Speed Loop Tuning | Position Loop Tuning | Tuning Graph | Step Response Statistics

Speed Loop Tuning Parameters

62.0000 Current Proportional Gain (KIPROP) <- Calculate

50.0000 Current Integral Gain (KIINT)

4.0000 Speed Proportional Gain (KVPROP)

1.0000 Speed Integral Gain (KVINT)

0 Motor Speed Filter

Test Move

MoveType: Speed Step

50.0000 Speed (% max. motor)

500.0000 Time at speed (ms)

Start Move

Undo Changes < Back Next > Cancel

4.4.6 Miscellaneous configuration

The Miscellaneous Configuration tab allows you to setup miscellaneous parameters. If you do not wish to make any changes, click **Next >** and go to section 4.4.7.

1. Click in the appropriate boxes and type the required values.

If you do not understand an item, click in its box and read the information shown in the help bar at the bottom of the window. The **Undo Changes** button can be used to reset all the items on the tab to their original values.

When you have finished, click **Next >** to continue.

Miscellaneous Configuration

Auxiliary Encoder

Auxiliary Encoder Select: Aux Encoder 0

1.0000 Auxiliary Encoder Scale

0.0000 Auxiliary Encoder Wrap

Auxiliary Encoder Mode

Auxiliary Encoder Direction Normal

Auxiliary Encoder Direction Reversed

Differential Line Receiver

Single Ended Controller

Encoder Inputs (A) and (B)

Step (A) and Direction (B)

Echo

Enable command line echo.

Enable error messages.

Enable command line prompt.

Undo Changes < Back Next > Cancel

4.4.7 Completing the configuration wizard

The configuration must now be saved.

(If you wish to go back and make any further changes, click **< Back** .

1. Check that the drop down box is showing **Mint Configuration File Format**. If it is not, then select this option.

Click **Next >** to continue.

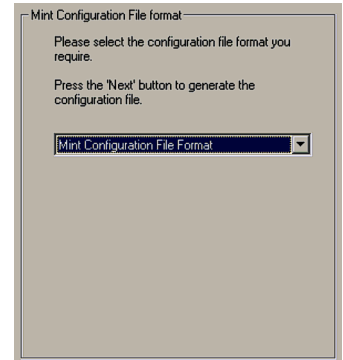

2. The completed configuration file will be shown.

If you wish to go back and make any further changes, click **< Back** .

Click **Finish** to continue.

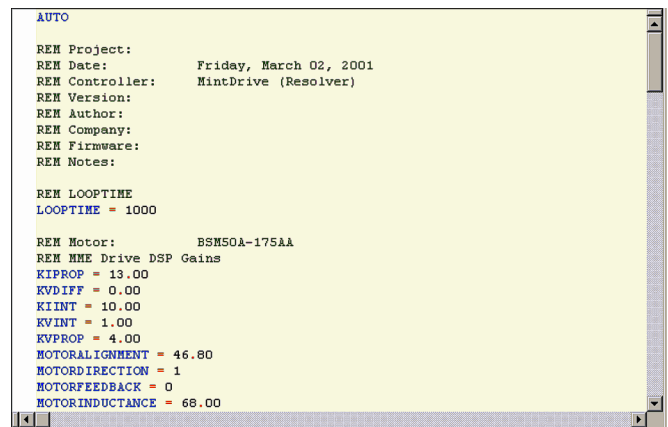

3. Check that the **Launch Mint Workbench and save the project and configuration files** option is selected.

Click **OK** to continue.

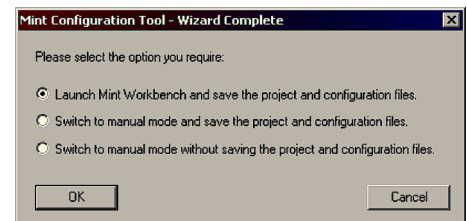

4. The **Save As** dialog box will be shown.

The first file to save is the project file.
This file can be loaded into MCT and edited later.

Select a folder and enter a filename for the project file.

Click **Save** .

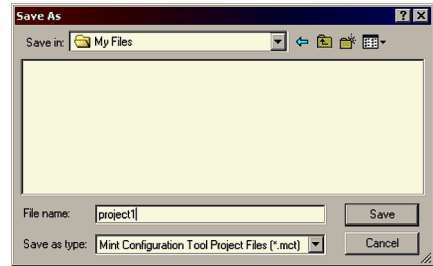

5. The second file to save is the configuration file.

This is the file that can be loaded into Mint Workbench
and sent to the MintDrive.

Select a folder and enter a filename for the
configuration file.

Click **Save** .

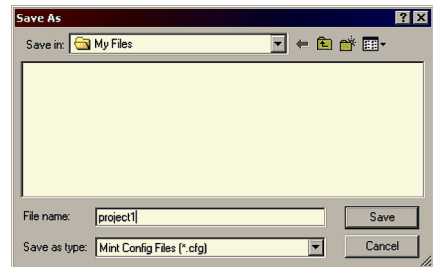

A number of things will now happen:

- The configuration file will be saved;
- MCT will be closed;
- Mint WorkBench will be started;
- The configuration file will be automatically loaded into WorkBench.

5.1 Outline

Mint WorkBench is the main application for programming and controlling the MintDrive. The Terminal window allows you control the MintDrive in real-time, while the Program window allows you to construct complex programs using the Mint™ programming language. The Configuration window allows you to view and alter the configuration file. For detailed information on Mint programming, see the *Mint v4 Programming Guide*.

5.1.1 Completing configuration

To complete the configuration process, the configuration file must be downloaded to the MintDrive.

On the Standard toolbar, click the download button .

In the dialog box that appears, click **Yes** to confirm download.

Click the  button at the top of the Configuration Editor window to close the window.

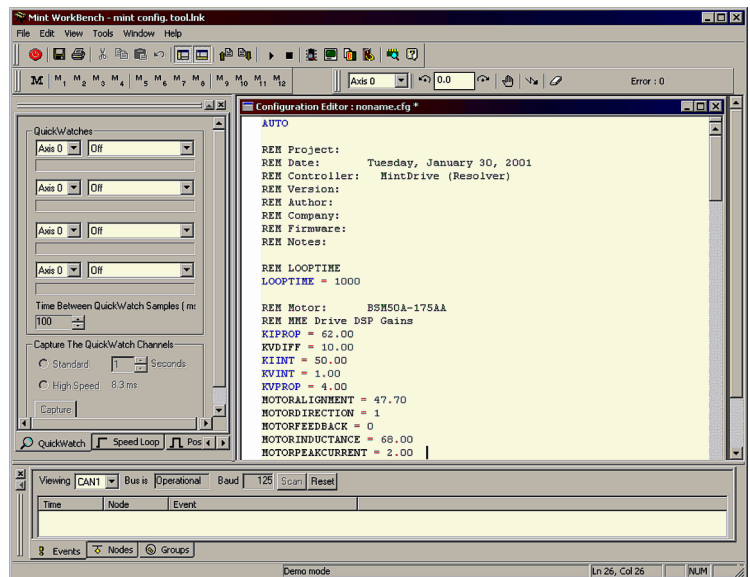

This completes the configuration and tuning.

The remainder of this section includes some simple motor movement commands that can be useful for testing.

5.2 Using WorkBench

If you have not just completed the Mint Configuration Tool Wizard, you will need to start Mint WorkBench manually. On the Windows **Start** menu, select **Programs, Mint v4, Mint WorkBench**.

5.2.1 Selecting the controller

Before WorkBench can communicate with the MintDrive, it must scan the PC's serial ports to find where it is connected. To do this, click **Tools** on the main menu and choose **Select Controller...**

The Select Controller dialog box will appear and WorkBench will scan the serial ports until it finds the MintDrive. When it has found the MintDrive, click **OK**.

Note: The MintDrive logic supply must be powered otherwise it will not be found.

If WorkBench was started automatically when you completed the MCT Wizard, you do not need to do this step.

5.2.2 Menus and buttons

The main Mint WorkBench window contains a menu system and toolbars. Many functions can be accessed from the menu or by clicking a button - use whichever you prefer. Most buttons include a 'tool-tip'; hold the mouse pointer over the button (don't click) and its description will appear.

5.2.2.1 Standard toolbar functions



- 1 **Controller reset** (*Not available on MintDrive*).
- 2 **Save** Displays the save dialog box.
- 3 **Print** Displays the print dialog box.
- 4 **Cut** Cuts the text selected in the editor window and places it on the clipboard.
- 5 **Copy** Copies the text selected in the editor window and places it on the clipboard.
- 6 **Paste** Pastes the text on the clipboard into the editor window at the cursor location.
- 7 **Undo** Reverses the last editing action.
- 8 **Watch window** Turns the watch window on or off.
- 9 **CAN window** Turns the CAN window on or off.
- 10 **Upload** Uploads the current file *from* the MintDrive *to* WorkBench.
- 11 **Download** Downloads the current file *to* the MintDrive *from* WorkBench.
- 12 **Run** Runs the current configuration and program files in the MintDrive.
- 13 **Stop** Stops the current program running on the MintDrive.
- 14 **DPR Watchwindow** (*Not available on MintDrive*).
- 15 **Terminal** Displays the Terminal window (CTRL+T has the same effect).
- 16 **Copy parameters** Copies the current drive tuning parameters to the clipboard.
- 17 **Digital I/O** Displays the digital I/O watch window.
- 18 **Platform information** Displays the platform information window.
- 19 **About** Displays WorkBench version number information.

5.2.2.2 Motion toolbar functions



- 1 **Axis selection** (Only Axis0 can be selected)
- 2 **Jog (reverse)** Causes the motor to start a reverse jog motion.
- 3 **Jog speed** Sets the jog speed (in user units per second)
- 4 **Jog (forward)** Causes the motor to start a forward jog motion.
- 5 **Stop** Stops the jog motion.
- 6 **Enable / Disable** Enables (sending a CANCEL command first) or disables the drive.
- 7 **Clear motion errors** If an error occurs, clears the error condition so operation can continue.
- 8 **Motion error** Displays the error code bitmap when a motion error occurs. Click the button to see a description of the error(s).

5.2.2.3 Macro toolbar functions

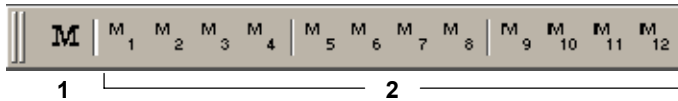

- 1 **Configure macros** Displays the Assign Macros to Function Keys F1..F12 dialog box.
- 2 **Execute macro** Starts the macro assigned to that button.

5.2.2.4 Status bar

The status bar provides information for the currently selected menu item or the status of WorkBench. It provides a useful reminder of the meaning of each function. Double click on the center section to display the Configure this Controller dialog.



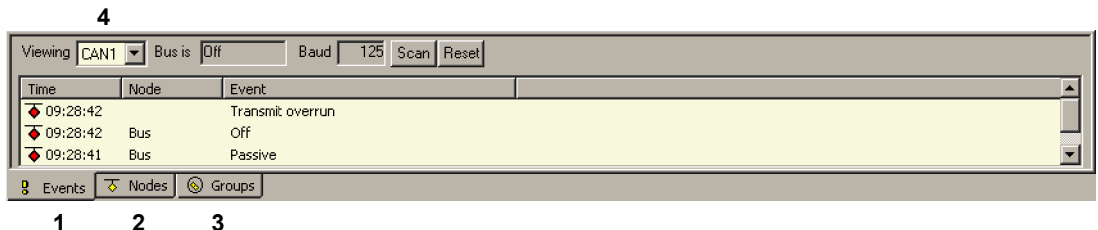

5.2.2.5 CAN window

The CAN window shows the current status of the CAN ports. If the MintDrive is not connected to a CAN network you can turn this window off by choosing **View, CAN Window** on the main menu or by clicking the CAN window button on the standard toolbar.



- 1 **Events** Displays current CAN events
- 2 **Nodes** Displays node information for the CAN network.
- 3 **Groups** Displays grouping information for the CAN network
- 4 **Viewing** Selects the CAN port to be monitored.

5.3 Watch window

The Watch window contains four tabs, providing real-time information and allowing tuning of the motor. If a tab is not visible, click the   buttons at the bottom of the window.

5.3.1 Quick Watch tab

The Quick Watch tab provides real-time information about various WorkBench and motor parameters. Up to four user selectable parameters can be monitored at the same time.

To select a parameter to be monitored, click one of the parameter boxes on the right of the QuickWatch tab.

In the drop down box that appears, click on the item you wish to monitor.

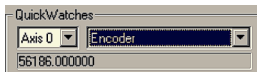

The value will appear in the line just below the drop down box.

Values are sampled, in turn, every 100ms although this can be changed by clicking the arrows beside the Time Between QuickWatch Samples (ms) box 

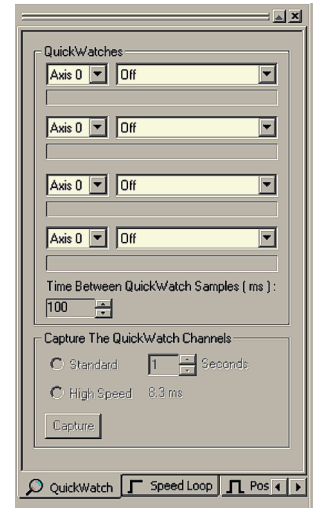

The Capture The QuickWatch Channels frame allows the selected parameters to be captured and shown on a graph. To select the sampling time, click the arrows beside the Seconds box  , then click the Capture button.

5.3.2 Speed Loop tab

The Speed Loop tab provides a further opportunity to tune the motor. Click in the appropriate boxes and type the required values.

Click **Start Move** to perform the move.

The motor will now rotate, WorkBench will upload the recorded (captured) data from the MintDrive and the Capture tab will be shown.

Note: If an error occurs, the **Error:** button on the Motion toolbar will show the error number. Click the button to see details of the error. Depending on the type of error that occurred, you might need to click the Clear Motion Errors button before further moves can be performed.

Speed Step performs a step speed change to the percentage of maximum motor velocity entered in the Speed (% max motor) box.

Current Proportional Gain (KIPROP)

The gain is set by MCT during the tuning process. If you need to recalculate this value, use the formula:

$$KIPROP = \frac{[740 \times L \times (A/V)]}{VAC}$$

where:

L = Line to neutral inductance of the motor in mH.

A/V = Amps / volt scaling of the current feedback.

VAC = Nominal line voltage

Current Integral Gain (KIINT)

This gain is preset to 50Hz and should not need to be adjusted.

Speed Proportional Gain (KVPROP)

This gain will speed up the response and but excessive values will cause overshoot, and possible instability.

Speed Integral Gain (KVINT)

Increasing the value of KVINT increases the low frequency gain and stiffness of the control, but excessive values will cause overshoot for transient speed commands and may lead to oscillation. If KVPROP and KVINT are set too high, an overshoot condition can also occur.

Speed differential gain (KVDIFF)

Theoretically this gain has a damping effect, although it is not implemented in the MintDrive.

For a full description of the tuning parameters, see Appendix A.

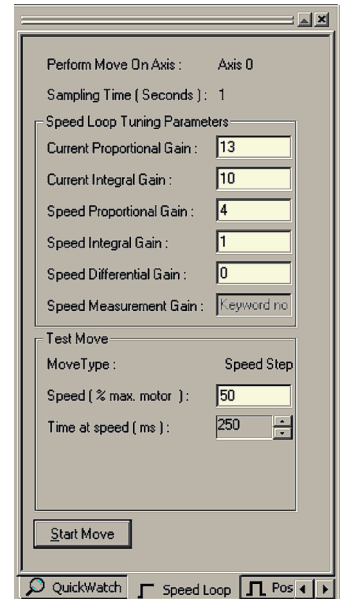

5.3.3 Position Loop tab

The Position Loop tab provides a further opportunity to tune the motor and perform test moves. Click in the appropriate boxes and type the required values. For a full description of the position loop tuning parameters, see Appendix A.

Click **Start Move** to perform the move.

The motor will now rotate, WorkBench will upload the recorded (captured) data from the MintDrive and the **Capture** tab will be shown.

Note: If an error occurs, the **Error:** button on the Motion toolbar will show the error number. Click the button to see details of the error. Depending on the type of error that occurred, you might need to click the Clear Motion Errors button before further moves can be performed.

Depending on the type of move chosen in the MoveType box, different options will appear below it:

Position Step performs a step position move of the distance entered in the Step Size (uu) box.

Position Trapezoid performs a trapezoidal move. The total distance of the move is entered in the Move Distance (uu) box. When the move is performed the demanded motor speed will increase at the rate entered in the Acceleration box until the Slew Speed is reached. Towards the end of the move, the demanded motor speed will decrease at the rate entered in the Deceleration box.

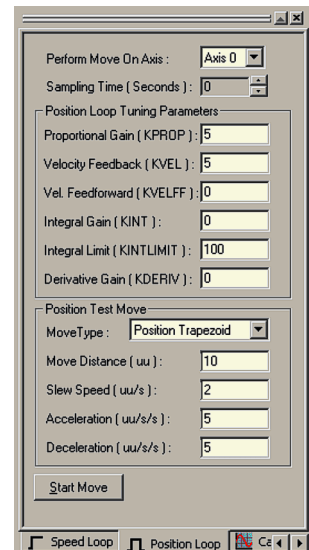

5.3.4 Capture tab

Each time a speed or position test move is performed using WorkBench, the data from the move is automatically captured and uploaded in to WorkBench. The Capture tab allows you to select the type of plot produced from the captured data. Click in the appropriate boxes to select the required data.

The Plot #1 and Plot #2 frames allow you to select which parameter(s) to show on the graph and the color of the traces. Plot #2 is only available after a Position move has been performed.

Normally, the graph will automatically scale itself to show the largest maximum and minimum captured values for the selected plot types. However, the Use the same axis as plot #1 check box forces the two traces to be plotted using the scaling required for plot #1. This allows the two sets of data to be compared with each other more easily.

The background color of the graph can be changed using the Background Color drop down box, and the grid can be turned on or off using the Show Grid check box. The Upload Captured Data From the Controller button allows you to manually upload the data.

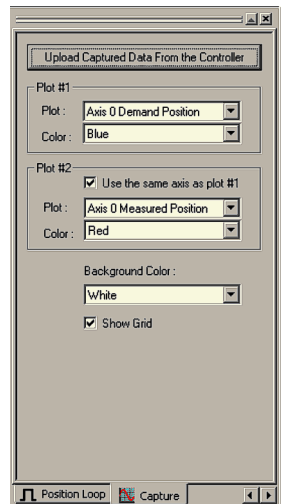

5.4 Editor windows

Mint WorkBench has three main editor windows; the Configuration window, the Program window and the Terminal window.

5.4.1 Configuration window

If the configuration window is not visible, select **Window, Configuration** from the main menu.

The configuration window is used for writing and editing the configuration file. Any file downloaded from this window to the MintDrive will be sent as the configuration file.

To view the current configuration stored in the MintDrive, click the upload button on the standard toolbar. After a couple of seconds, the current configuration file will be displayed.

To download the configuration file to the MintDrive, click the download button on the standard toolbar.

In the dialog box that appears, click **Yes** to confirm download. Saved configuration files can also be loaded into the configuration window using **File, Open, Config...** on the main menu.

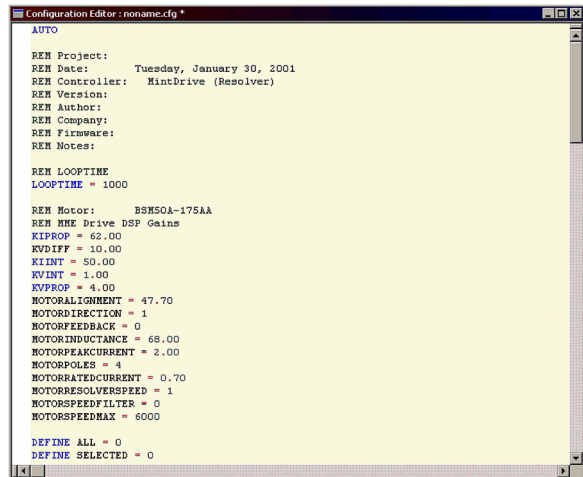

```
AUTO
REM Project:
REM Date:    Tuesday, January 30, 2001
REM Controller:  MintDrive (Resolver)
REM Author:
REM Company:
REM Firmware:
REM Notes:

REM LOOPTIME
LOOPTIME = 1000

REM Motor:    BMS0A-175AA
REM HME Drive DSP Gains
KIPROP = 82.00
KVIDIFF = 10.00
KIINT = 50.00
KVINT = 1.00
KVPROP = 4.00
MOTORALIGNMENT = 47.70
MOTORDIRECTION = 1
MOTORFEEDBACK = 0
MOTORINDUCTANCE = 68.00
MOTORPEAKCURRENT = 2.00
MOTORPOLES = 4
MOTORRATECURRENT = 0.70
MOTORRESOLVERSPEED = 1
MOTORSEEDFILTER = 0
MOTORSEEDMAX = 6000

DEFINE ALL = 0
DEFINE SELECTED = 0
```

5.4.2 Program window

If the program window is not visible, select **Window, Program** from the main menu.

The program window is used for writing and editing programs. Any file downloaded from this window to the MintDrive will be sent as the program file.

To view the current program stored in the MintDrive, click the upload button on the standard toolbar. After a couple of seconds, the program file will be displayed. If there is no program in the MintDrive, the window will remain blank.

To download the program file to the MintDrive, click the download button on the standard toolbar.

In the dialog box that appears, click **Yes** to confirm download. Saved program files can also be loaded into the program window using **File, Open, Program...** on the main menu.

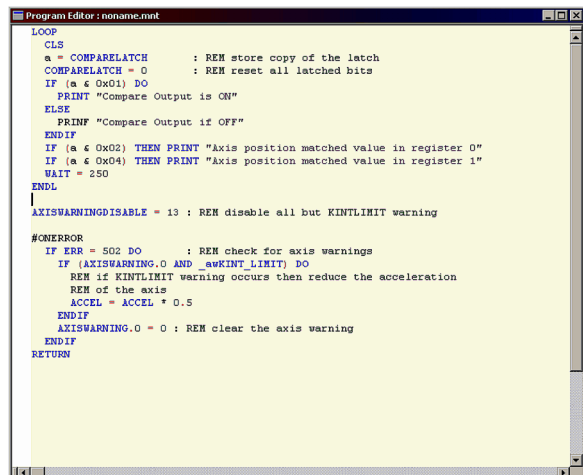

```
Program Editor : noname.mnt
LOOP
CLS
a = COMPARELATCH      : REM store copy of the latch
COMPARELATCH = 0     : REM reset all latched bits
IF (a & 0x01) DO
PRINT "Compare Output is ON"
ELSE
PRINT "Compare Output if OFF"
ENDIF
IF (a & 0x02) THEN PRINT "Axis position matched value in register 0"
IF (a & 0x04) THEN PRINT "Axis position matched value in register 1"
WAIT = 250
ENDL
|
AXISWARNINGDISABLE = 13 : REM disable all but KINTLIMIT warning

#ONERROR
IF ERR = 502 DO
IF (AXISWARNING.0 AND _awKINT_LIMIT) DO
REM if KINTLIMIT warning occurs then reduce the acceleration
REM of the axis
ACCEL = ACCEL * 0.5
ENDIF
AXISWARNING.0 = 0 : REM clear the axis warning
ENDIF
RETURN
```

5.4.3 Terminal window

If the terminal window is not visible, select **Tools, Terminal** from the main menu. (Alternatively, click the Terminal button on the standard toolbar or press CTRL+T).

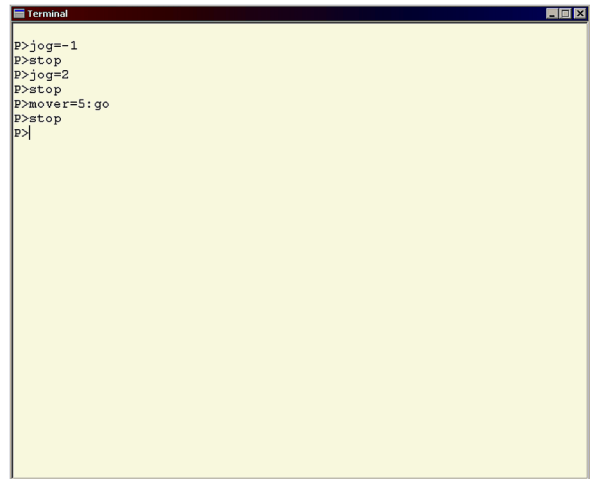

The Terminal window can be used for controlling the MintDrive directly and for monitoring output messages from programs.

On the PC keyboard, press the Enter key once to display the C001> or P001> prompt. Commands typed in the Terminal window will have immediate effect on the MintDrive, although the command line will not be available while a program is running.



```
terminal
P>jog=-1
P>stop
P>jog=2
P>stop
P>move=5:go
P>stop
P>|
```

5.4.4 Useful commands for testing

The Terminal window can be a useful tool for performing simple tests. Before testing can begin, check that the enable button  on the motion toolbar is pressed; the MintDrive Monitor LED display should be showing the  symbol.

The following examples can now be typed in the Terminal window:

To start the motor turning slowly, type...

JOG=1 followed by the Enter key.

The motor will begin to rotate at a speed of 1 user unit per second. If you have followed all the previous examples, this means the motor will rotate at one revolution per second.

To stop the motor turning, type...

STOP followed by the Enter key.

The motor will stop.

To start the motor turning in reverse, then change direction type...

JOG=-1 followed by the Enter key. Then type:

JOG=1 followed by the Enter key.

The motor will immediately change direction. Type:

STOP to stop the motor.

To turn a distance of 5 turns, type...

`MOVER=5` followed by the Enter key. Then type:
`GO` followed by the Enter key.

The keyword `MOVER` means “MOVE Relative”. In this example the motor will turn 5 units. If you have followed all the previous examples, this means the motor will rotate five revolutions.

To change the speed, type...

`SPEED=0.5` followed by the Enter key.

The motor will not turn, but the next time you use a `MOVER` command, the motor will now turn at half of one revolution per second. To try it type:

`MOVER=2` followed by the Enter key,
`GO` followed by the Enter key.

Combining commands on one line...

Commands can be combined on one line by separating them with colons. For example, type:

`SPEED=2:MOVER=8:GO` followed by the Enter key.

The motor will immediately turn for 8 revolutions at a speed of 2 revolutions per second.

To learn more about using these commands and how to incorporate them into programs, see the *Mint v4 Programming Guide*. Using the Mint programming language, sophisticated programs can be written that control the motor, set outputs and, most importantly, respond to external inputs.

5.4.5 Firmware update

Occasionally there may be updates to Mint to either fix problems or to add new features. The Mint firmware is stored in Flash memory and can be updated using the RS232 serial port. The RS485 port cannot be used for firmware update.

 **CAUTION:** The state of the analog and digital outputs cannot be guaranteed while firmware is being updated. Please disconnect any equipment which may be damaged.

 **CAUTION:** It is recommended to remove any AUTO configuration file prior to updating firmware. Changing the firmware may affect the way your Mint application works.

 **CAUTION:** Updating firmware may destroy any program(s) held in the battery backed-up RAM buffers. You should upload these into Mint WorkBench and save them before updating the firmware.

 **CAUTION:** Updating firmware will destroy any program(s) held in the Flash memory buffers. You should upload these into Mint WorkBench and save them before updating the firmware.

From the **Tools** menu, select **Update Firmware** and follow the instructions on screen.

Once the firmware has been updated, both the Configuration and Program flash buffers will need to be reset. The Mint keyword `BUFFERSTORE` can be used to switch between battery backed-up RAM and flash buffers. Typing:

`BUFFERSTORE=0` will switch to the battery-backed RAM buffer. Typing:

`BUFFERSTORE=1` will switch to the flash buffer.

With the flash buffer selected, type:

`CON` to select the configuration buffer (if it is not already selected).

A few report lines will be shown, followed by the `C>` prompt. Type:

`NEW` at the prompt to reset the buffer.

Now type:

`PROG` to select the program buffer.

A few report lines will be shown, followed by the `P>` prompt. Type:

`NEW` at the prompt to reset the buffer.

It is recommended to update the keyword tables supported by the controller after updating it with new firmware. This allows the Mint WorkBench editor to identify keywords recognized by the controller. To update the keyword tables, select **Load Syntax** from the **Edit** menu in Mint WorkBench.

6.1 Outline

This section provides technical specifications of the MintDrive variants

6.1.1 General specifications

The MintDrive is an integrated motion controller and brushless AC servo drive with internal power supply.

- Five current output ratings are available: 2.5A, 5A, 7.5A, 10A and 15A
- Four voltage input ratings are available: 115VAC or 230VAC single-phase, with three-phase variants available on the 10A and 15A units
- An optional internal 24V power supply for control electronics is available
- Resolver or encoder feedback
- 18 optically isolated digital inputs (12-24VDC $\pm 20\%$), configurable for PNP or NPN operation. Software configurable for forward limit, reverse limit, stop and home. Two inputs configurable for high speed position latch (CAPT) on axis position and master encoder position
- 9 optically isolated digital outputs. Four outputs configurable for PNP or NPN operation. One output rated at 1A, all others at 50mA.
- Four analog input channels:
 - One single ended input 0-10V, 10-bit resolution
 - One differential input: $\pm 10V$, auto selecting resolution - 12-bit below 1VDC, 10-bit above 1VDC
 - Two differential inputs: $\pm 10V$, 12-bit.
- Four analog output channels:
 - Two bipolar outputs: $\pm 10V$; 8-bit resolution, 1mA output
 - Two bipolar outputs: $\pm 10V$; 8-bit resolution, 4mA output
- Two channel serial interface: RS232 and 4-wire RS485
- Two channel CAN interface: CANopen DS401 master and Baldor CAN protocol
- Seven segment display for diagnostics.

6.1.2 Power

Mains and motor output

	Unit	2.5A	5A	7.5A	10A	15A
Nominal input voltage ($V_{in}=230VAC$)	VAC	230				
Minimum input voltage		220				
Maximum input voltage		250				
Nominal DC-Bus voltage	VDC	320				
Minimum DC-Bus voltage		306				
Maximum DC-Bus voltage		350				
Nominal input voltage ($V_{in}=115VAC$)	VAC	115				
Minimum input voltage		97				
Maximum input voltage		125				
Nominal DC-Bus voltage	VDC	160				
Minimum DC-Bus voltage		135				
Maximum DC-Bus voltage		176				
Output voltage (line-line) @VDC-Bus=320V	V_{RMS}	0 ~ 230				
Nominal phase current ($\pm 10\%$)	A_{RMS}	2.5	5.0	7.5	10	15
Peak phase current ($\pm 10\%$) for 2.4s (+0.5s / -0s)	A_{RMS}	5	10	15	20	30
Nominal output power	kVA	1.01	2.17	2.99	4.33	6.51
Efficiency	%	>95				
Output frequency	Hz	0 ~ 500				
Nominal switching frequency	kHz	8.5				

Optional 24V supply

	Unit	All models
Input voltage $V_{RIPPLE} = 10\%$	minimum maximum	20 30
Input current @24VDC	maximum	1.6
Surge current at power on @24VDC for 100ms	A_{RMS}	4

6.1.3 Rectifier and regeneration

Rectifier

		Unit	All models	
Input voltage ($\pm 15\%$, $f=50\sim 60\text{Hz}$)		VAC	$V_{in}=230\text{VAC}$	$V_{in}=115\text{VAC}$
	Nominal		230	115
	Minimum		190	90
	Maximum	265	130	
DC-Bus voltage (absolute)	Minimum	VDC	270	125
	Maximum		360	175

Regeneration

	Unit	2.5A*	5A*	7.5A	10A	15A
Switching threshold $V_{in}=230\text{VAC}$ $V_{in}=115\text{VAC}$	VDC	on:373~383, off:362~372			on:373~383, off:362~372	
		on:188~195, off:183~188			on:188~195, off:183~188	
Nominal power	kW	0.25			1.0	
Peak power	kW	2.7			15	
Maximum regeneration switching current	A _{RMS}	10			40	
Maximum load inductance	mH	100				

*Note: 2.5A model contains an internal 320Ω, 20W resistor
5A model contains an internal 175Ω, 30W resistor.

6.1.4 Resolver feedback

	Unit	All models
Resolution set automatically by software	bits	Velocity <6100RPM: 14 bits Velocity >6100RPM: 12 bits
Pole pairs	-	1
Resolver winding ratio	-	0.5
MintDrive resolver input accuracy	counts	± 2
Typical combined accuracy using Baldor BSM series resolver motor	counts	± 4

6.1.5 Encoder feedback

	All models
Encoder input	A/B Differential, Z index
Signal frequency (maximum)	1.5MHz (6MHz quadrature)
Hall inputs	Single ended, 5V logic

6.1.6 Control signals

Encoder output (simulated)

	Unit	All models
Signal	-	RS422
Encoder resolution Resolver Encoder	-	1024ppr, simulated 1024ppr / 2500ppr (actual encoder lines) (Baldor BSM series motor)

Master (auxiliary) encoder input

	Unit	All models
Signal	-	RS422
Operating mode	-	A/B quadrature
Maximum input frequency (quadrature)	MHz	8
Sample time	ms	Selectable: 0.5, 1, 2

Serial RS232 interface

	Unit	All models
Signal	-	RS232, non-isolated CTS/RTS
Bit rate	Baud	9600, 19200, 57600

Serial RS485 interface

	Unit	All models
Signal	-	4-wire RS485, non-isolated
Bit rate	Baud	9600

CAN Bus interfaces

	Unit	All models
Signal	-	2-wire, isolated
Channels	-	2
Bit rate	Kbit/s	10, 20, 50, 125, 250, 500, 1000 (800 also available on CAN bus 1 only)
Protocols	-	CAN bus 1: CANopen CAN bus 2: Baldor CAN

6.1.7 Environmental

	Unit	All models	
Operating temperature range Minimum Maximum Derate		°C	°F
		+5 +40 2.5% / °C between 40°C and 50°C (max)	+41 +104 2.5% / 1.8°F between 40°C and 50°C (max)
Storage temperature range		-25 ~ +70	-13 ~ +158
Humidity	%	10~90 non-condensing according to DIN40 040 / IEC144	
Maximum installation altitude (above m.s.l.)	m	1000 Derate 1.1% / 100m over 1000m	
	ft	3300 Derate 1.1% / 330ft over 3300ft	
Shock	-	10G according to DIN IEC 68-2-6/29	
Vibration	-	1G, 10~150Hz, according to DIN IEC 68-2-6/29	

7.1 Outline

This section explains common problems that may be encountered and their solutions. If you want to know the meaning of the LED Monitor display, see section 1.3 on page 3.

7.1.1 Problem diagnosis

If you have followed all the instructions in this manual in sequence, as instructed, you should have few problems installing the MintDrive.

If you do have a problem, check through the diagnosis sections below. If you cannot solve the problem, or the problem persists, contact details for Baldor Technical Support are provided at the front of this manual.

Before contacting Technical Support, please have ready the following information (if available):

- The Serial Number of your MintDrive.
- The Catalog Number indicating the type of MintDrive you have.
- Assuming you have access to the command line, type `VER` and note down the software version number and the build number.
- Assuming you have access to the command line, type `VIEW HARDWARE` and note down the information given.
- The catalog number of the motor that you are using.
- The version of Mint WorkBench that you are using (click **Help, About** on the main menu).
- Give a clear description of what you are trying to do, for example trying to establish communications with the Mint WorkBench, trying to run the Feedback Alignment test under the Drive Setup dialog or trying to setup Mint gains.
- Give a clear description of the symptoms that you can observe, for example the current state of any of the status indicators, error messages displayed, the current value of any of the Mint error keywords `AXISERROR`, `AXISSTATUS`, `MISCERROR`, `DRIVEFAULT`, `ERR` and `ERL`.
- The type of motion generated in the motor shaft.
- Give a list of any parameters that you have setup, for example the motor data you entered/selected from the "Drive Setup" dialog, the gain settings generated by MCT during the tuning process and any gain settings you have entered yourself.

Depending upon the nature of your problem you may be asked for some or all of the above information.

The term "Power-cycle the MintDrive" is used in the following sections.

This means turn the MintDrive off, wait for it to power down completely, then turn it on again.

7.1.2 Communication

Problem	Check
No LEDs are illuminated (+24VDC models)	Check that the 24VDC power supply is connected on connector X1 and is switched on.
No LEDs are illuminated (Mains only models)	Check the mains supply is connected and switched on.
Mint WorkBench fails to detect the MintDrive - it detects another controller	Mint WorkBench automatically attempts to re-select the last controller to which it was connected. Select Tools, Select Controller on the main menu. Check that MintDrive has been selected in the drop-down. If not, select it.
Mint WorkBench fails to detect the MintDrive - it detects "Controller with No Firmware" on the serial port.	<p>Ensure that the MintDrive is powered and the LEDs are illuminated (see section 1.3 on page 3).</p> <p>Check that the RS232 cable is connected between the PC serial port and to connector X7 on the MintDrive.</p> <p>Check the wiring of the RS232 cable or try an alternate cable.</p> <p>If available on the PC, try an alternative serial port.</p> <p>Confirm that a mouse driver or other serial device is not conflicting with Mint WorkBench.</p>
Cannot communicate with the MintDrive over the RS232 port (cannot get P> or C> prompt by pressing Enter).	<p>Check that Mint WorkBench has detected the MintDrive, indicated in the status bar at the bottom of the window.</p> <p>Check that the MintDrive is still powered.</p> <p>Check that the focus is on the Terminal window of the Mint WorkBench (click in the Terminal window).</p> <p>Check that there is not a program already running on the MintDrive (press CTRL+E to abort the running program).</p> <p>Check that a program hasn't disabled the RS232 terminal using the <code>TERMINAL</code> keyword (pressing CTRL+E will re-enable the RS232 serial port).</p> <p>Check that the Monitor LED is illuminated.</p> <p>Power-cycle the MintDrive.</p>

7.1.3 Power up

Problem	Check
No LEDs are illuminated	Check that the 24VDC power supply is connected on connector X1 and is switched on. Check the mains supply is connected and switched on.
One or more of the Monitor, Ready or CAN LEDs is not illuminated	Check power connections. Power-cycle the MintDrive. If the problem persists contact Baldor Technical Support.
The 'Ready' LED is red.	The drive has detected an error. Type <code>PRINT DRIVEFAULT</code> in the Terminal window or click the error button on the motion toolbar to find the error code(s). See section 7.1.6 on page 91.
A CAN LED is red or flashing red.	See section 7.1.7 on page 94.
The Ready LED is green and the Monitor LED indicates 'L'	The drive has powered-up into 'Local' mode. Power-cycle the MintDrive. If the problem persists then contact Baldor Technical Support.
The Ready LED is green and the Monitor LED indicates 'E'	The MintDrive has detected a motion error. Type <code>PRINT AXISERROR</code> at the command line or click on the error button on the motion toolbar to find the error code(s). Click the Clear Motion Errors button on the motion toolbar.
The message <code>Variables corrupted. Use RELEASE.</code> is shown at power-up.	Type <code>RELEASE</code> in the Terminal window to clear variables from the variable stack. If the problem persists then this indicates a battery problem. Trickle charge the MintDrive's battery by leaving the unit powered for 24~48 hours. If the problem still persists contact Baldor Technical Support.
The message <code>Memory Corruption. Use NEW to clear buffers.</code> is shown at power-up.	Type <code>NEW</code> at the Configuration prompt (type <code>CON</code> to display <code>C></code>). Type <code>NEW</code> at the Program prompt (type <code>PROG</code> to display <code>P></code>). This will clear the corrupted programs from memory. If the problem persists then this indicates a battery problem. Trickle charge the MintDrive's battery by leaving the unit powered for 24~48 hours. If the problem still persists contact Baldor Technical Support.

Problem	Check
<p>The message <code>Lost User Data: Defaulting to Factory settings - please wait...</code> is shown at power-up.</p>	<p>If this message is followed by <code>You must now re-tune your motor</code> retune the MintDrive by either re-entering the gain settings set earlier or by following the tuning setup (see section 4.2 on page 51).</p> <p>If this message is followed by <code>Failed to automatically reset Factory settings</code>. power-cycle the MintDrive. If the same message re-appears or the Ready LED stays red, contact Baldor Technical Support. Otherwise, retune the MintDrive by either re-entering the gain settings set earlier or by following the tuning setup (see section 4.2 on page 51).</p> <p>If this message is followed by <code>Factory settings have been reset, but failed to clear error flag</code>. Try clearing the error manually using <code>CANCEL</code>. type <code>CANCEL</code>. and power-cycle the MintDrive. If the same message re-appears or the Ready LED stays red, contact Baldor Technical Support. Otherwise, retune the MintDrive by either re-entering the gain settings set earlier or by following the tuning setup (see section 4.2 on page 51).</p>
<p>The message <code>Initialization Error</code> is shown at power-up.</p>	<p>Contact Baldor Technical Support.</p>
<p>The message <code>Fatal Initialization Error</code> is shown at power-up.</p>	<p>Contact Baldor Technical Support.</p>
<p>The message <code>Processor Reset Code = xx</code> is shown at power-up.</p>	<p>If new firmware has just been downloaded this message may be ignored.</p> <p>If the MintDrive has been power-cycled, power-cycle the MintDrive again. If the problem persists contact Baldor Technical Support.</p> <p>If the firmware just reset without the unit being power-cycled, contact Baldor Technical Support.</p>

7.1.4 Tuning

The following problems could occur when the software is performing automatic tuning tests. If the Ready LED is red during any of the tests see section 7.1.6 on page 91.

Check that the software can communicate with the MintDrive by typing `PRINT DRIVEFAULT` in the Terminal window. If no error is reported then communication can be achieved.

Problem	Check
Current Loop compensation test fails.	<p>If the MintDrive has the internal 24VDC supply, check that the mains is powered and connected.</p> <p>Check that the motor UVW cable is connected. Check that the feedback cable is connected. Repeat the test.</p> <p>Power-cycle the unit and repeat the test.</p> <p>Click the Calculate button and use this value or enter the Current proportional gain manually and proceed to the feedback alignment test.</p>
Feedback alignment test fails	<p>If the MintDrive has the internal 24VDC supply, check that the mains is powered and connected.</p> <p>Check that the motor UVW cable is connected. Check that the feedback cable is connected. Repeat the test.</p> <p>Power-cycle the unit and repeat the test.</p> <p>Check the motor data settings (number of poles, resolver speeds etc.) have been entered correctly.</p> <p>Check the wiring of the feedback cable.</p> <p>Check that the resolver cable is physically separated from power cables. If the resolver cable has to cross power cables, check that they cross at an angle of 90 degrees.</p> <p>Enter the default angle of 23 degrees (for a 8-pole motor) or 46 degrees for a 4-pole motor.</p>
Speed Controller Calculations test fails	<p>If the MintDrive has the internal 24VDC supply, check that the mains is powered and connected.</p> <p>Check that the motor UVW cable is connected. Check that the feedback cable is connected.</p>

7.1.5 Mint gains

Problem	Check
Cannot enable the MintDrive because AXISERROR has bit 13 set	<p>Check the drive enable input on connector X13-1 and X13-12 is connected and that the input is enabled.</p> <p>Check that you have configured the MintDrive, for example: CONFIG = <code>_cfSERVO</code> or CONFIG = <code>_cfCURRENT_AMPLIFIER</code></p>
When the MintDrive is enabled the motor is unstable	<p>If a "Lost User Data" error (DRIVEFAULT = 21) has occurred recently you must retune the current loop.</p> <p>Check that the current loop has been tuned. Check that the current loop was tuned with the correct motor data.</p> <p>If, after removing Mint gains, the motor is still unstable try reducing the Speed Proportional gain and Speed Integral gain.</p>
I get a Following Error (AXISERROR bit 5 is set) and the drive disables when tuning the Mint gains	<p>Set FOLERRORMODE to zero to ignore the following error while tuning the Mint gains.</p>
I get a Software limit error (AXISERROR bits 3 or 4 set) and the drive disables when tuning the Mint gains	<p>Set SOFTLIMITMODE to zero to ignore the software limit error while tuning the Mint gains.</p>
I get a Hardware limit error (AXISERROR bits 1 or 2 set) and the drive disables when tuning the Mint gains	<p>Set LIMITMODE to zero to ignore the hardware limit errors while tuning the Mint gains. Alternatively, disable the hardware limit inputs.</p>

7.1.6 Ready LED is red

If the Ready LED is illuminated red and the Monitor LED shows \mathcal{E} , at the command line type `PRINT DRIVEFAULT`.

This will return one of the codes listed below. Alternatively, click on the error button on the motion toolbar, which will also display the drive fault.

If the code is not listed below please contact Baldor Technical Support.

Code	Problem	Check
3	Power Base ID fault	The MintDrive does not recognize the power base ID. Type <code>CANCEL</code> . If the fault does not clear, power-cycle the MintDrive. If the fault persists type <code>VIEW HARDWARE</code> , make a note of the 'Power Base ID' number and contact Baldor Technical Support.
4	Insufficient Bus Volts at start-up	DC Bus Low detected at power-up Check the mains supply, re-instate and type <code>CANCEL</code> .
6	Current Sense fault	Defective phase current sensor or open circuit detected between control board and current sensor. Contact Baldor Technical Support.
7	Power Base fault	Desaturation of power device occurred or the bus current threshold was exceeded. If this occurs when enabling the drive, disconnect the motor cable and power-cycle the unit. If this cures the fault check the motor cable wiring for low impedance shorts. If this occurs during high acceleration and deceleration, reduce the Mint <code>ACCEL</code> and <code>DECEL</code> parameters and the Current Proportional gain and Speed Proportional gain.
9	Resolver fault / Encoder Loss	Resolver/Encoder feedback problem is indicated Check the wiring of the encoder / resolver cable at both ends. If using an encoder, check that +5VDC is being supplied to the encoder and that 3.5VDC is being returned on each of the encoder channels.
10	Logic supply fault	Logic power supply not working properly or supply has dropped below the minimum input voltage (24VDC models only). Check that 24VDC is being supplied to the MintDrive. Replace power supply. If the problem persists, contact Baldor Technical Support.

Code	Problem	Check
12	Over voltage fault	<p>Bus over voltage condition occurred.</p> <p>If this occurs during high deceleration, a regeneration resistor might need to be installed. If a regeneration resistor is already installed check the wiring and if it has an adequate rating. Alternatively, try decreasing the Mint DECEL parameter.</p> <p>Check that the correct AC voltage is being supplied for the power rating of your MintDrive.</p> <p>Check for power input line disturbances (mains spikes) and fit a mains filter.</p> <p>Measure the actual input voltage being supplied to the MintDrive and check that it is within the specification.</p> <p>If the problem persists, contact Baldor Technical Support.</p>
15	Under voltage fault	<p>DC Bus Voltage has fallen below minimum threshold.</p> <p>If this occurs during acceleration then the load may be too great for the acceleration selected. Try reducing the value of the Mint ACCEL parameter.</p> <p>Check that the correct AC voltage is being supplied for the power rating of your MintDrive.</p> <p>If the fault occurs immediately after power-up, remove the regeneration resistor (if connected) and try again.</p> <p>Check for power input line disturbances (sags caused by start-up of other equipment).</p> <p>Measure the actual input voltage being supplied to the MintDrive and check that it is within the specification</p> <p>If the problem persists, contact Baldor Technical Support.</p>
16	Overload	<p>The current rating of the drive has been exceeded.</p> <p>Check the motor and feedback wiring.</p> <p>If this occurs during high acceleration rates, decrease the Mint ACCEL parameter and/or reduce the motor load.</p> <p>Check the motor and load for excessive friction or improper operation such as a broken gear in a gearbox.</p>

Code	Problem	Check
17	Over speed fault	<p>Motor RPM exceeded 110% of programmed MAX Motor speed.</p> <p>Type <code>PRINT MAXMOTORSPEED</code>. If the value returned exceeds the maximum mechanical speed of the motor specified in the catalog, type <code>MAXMOTORSPEED = xxxx</code> where xxxx is the maximum speed listed in the catalog, in RPM.</p> <p>You should retune the motor after changing this parameter.</p> <p>Check the Mint demanded velocity by using either the QuickWatch tab or Capture tab and compare with the <code>MAXMOTORSPEED</code> parameter. If the Mint demanded velocity is greater than the maximum speed of the motor, modify your Mint program to generate a slower demand velocity.</p>
19	Control temp fault	<p>Temperature of drive heatsink exceeded safe level.</p> <p>Check correct operation of fans (if fitted) and ensure that they are clear of dirt.</p> <p>Check the ambient temperature around the drive.</p> <p>Ensure that the unit is adequately ventilated.</p> <p>If the problem persists add additional cooling.</p>
21	Lost User Data	<p>Battery backed RAM parameters have been lost or corrupted.</p> <p>If the fault did not clear automatically after power-up, enter the "Drive Setup" dialog and retune the MintDrive by following the tuning setup (see section 4.2 on page 51).</p>
22	Microprocessor reset	<p>Turn off the power supply and wait for the residual Bus voltage to reach 0VDC before turning on.</p> <p>Power-cycle the MintDrive. Check power-supply</p>
26	New Base Id fault	<p>Control board was changed since last operation.</p> <p>Power-cycle the MintDrive.</p>
31	Feedback module fault	<p>Indicates a problem with the feedback device.</p> <p>If the problem persists after you have power-cycled the MintDrive and you are using an encoder, rotate the motor shaft and power-cycle the MintDrive again</p>
32	Serial watchdog fault	<p>Inter-processor communication problem.</p> <p>Abort any program that may be running by pressing CTRL+E.</p> <p>Type CANCEL. If the fault re-appears, power-cycle the MintDrive.</p>

7.1.7 CAN

Use this section to troubleshoot any problems encountered when connecting to CAN. Full details of setting up CAN devices can be found in Appendix B.
For information about CAN error messages reported through Mint, see the *Mint v4 Programming Guide*.

Problem	Check
The CAN1 LED is illuminated red	<p>The CAN1 bus is off.</p> <p>Check that there is a 24VDC supply to the CAN network.</p> <p>Check that all nodes are running at the same baud rate.</p> <p>Check the CAN cable.</p> <p>Check for sources of errors on the bus.</p> <p>Type <code>CANBUSRESET</code> to reset the bus.</p>
The CAN1 LED is flashing red	<p>The CAN bus is passive. This means that the bus is operational but errors are occurring.</p> <p>Check that all nodes are running at the same baud rate.</p> <p>Check that each node has been assigned a unique NodeID.</p> <p>Check that the network has been terminated at each end. If the MintDrive is at the end of the network, check that the CAN1 switch on the front panel is in the ON position.</p> <p>Check the CAN cable.</p> <p>Check for sources of errors on the bus.</p> <p>Type <code>CANBUSRESET</code> to reset the bus.</p>
The CAN2 LED is illuminated red.	<p>The CAN2 bus is off.</p> <p>Check that there is a 24VDC supply to the CAN network.</p> <p>Check that all nodes are running at the same baud rate.</p> <p>Check the CAN cable.</p> <p>Check for sources of errors on the bus.</p> <p>Type <code>CANBUSRESET</code> to reset the bus.</p>

Problem	Check
The CAN2 LED is flashing red.	<p>The CAN bus is passive. This means that the bus is operational but errors are occurring.</p> <p>Check that all nodes are running at the same baud rate.</p> <p>Check that each node has been assigned a unique NodeID.</p> <p>Check that the network has been terminated at each end. If the MintDrive is at the end of the network, check that the CAN2 switch on the front panel is in the ON position.</p> <p>Check that the jumpers on each CAN peripheral are in the correct position. JP1 and JP2 should be set for bus 2 (see page 120).</p> <p>Check the CAN cable.</p> <p>Check for sources of errors on the bus.</p> <p>Type <code>CANBUSRESET</code> to reset the bus.</p>

A.1 Introduction

Within the MintDrive control software, instantaneous axis position demands produced by the MintDrive software must be translated into motor currents. This is achieved by closed loop control of the motor. The motor is controlled to minimize the error between the demanded and measured positions (often known as the following error). An incremental encoder or a resolver is used to measure the motor position. Every 1ms* the MintDrive compares demanded and measured positions and calculates the correct demand for the motor. The corrective signal is calculated by a PIDVF (Proportional, Integral, Derivative and Velocity Feed Forward) algorithm.

On the following page, Figure A.1 shows the MintDrive's positional, speed and current control loops. These are internal MintDrive control loops which can be tuned using the following keywords:

Purpose	Name	Abbreviation / keyword
Position Control	Proportional gain	KPROP
	Integral gain	KINT
	Velocity Feedback	KVEL
	Velocity Feedforward	KVELFF
	Derivative gain	KDERIV
	Acceleration Feedforward	KACCEL
Velocity Control	Proportional gain	KVPROP
	Integral gain	KVINT
Current Control	Proportional gain	KIPROP
	Integral gain	KIINT

* The 1ms sampling interval can be changed using the `LOOPTIME` keyword.

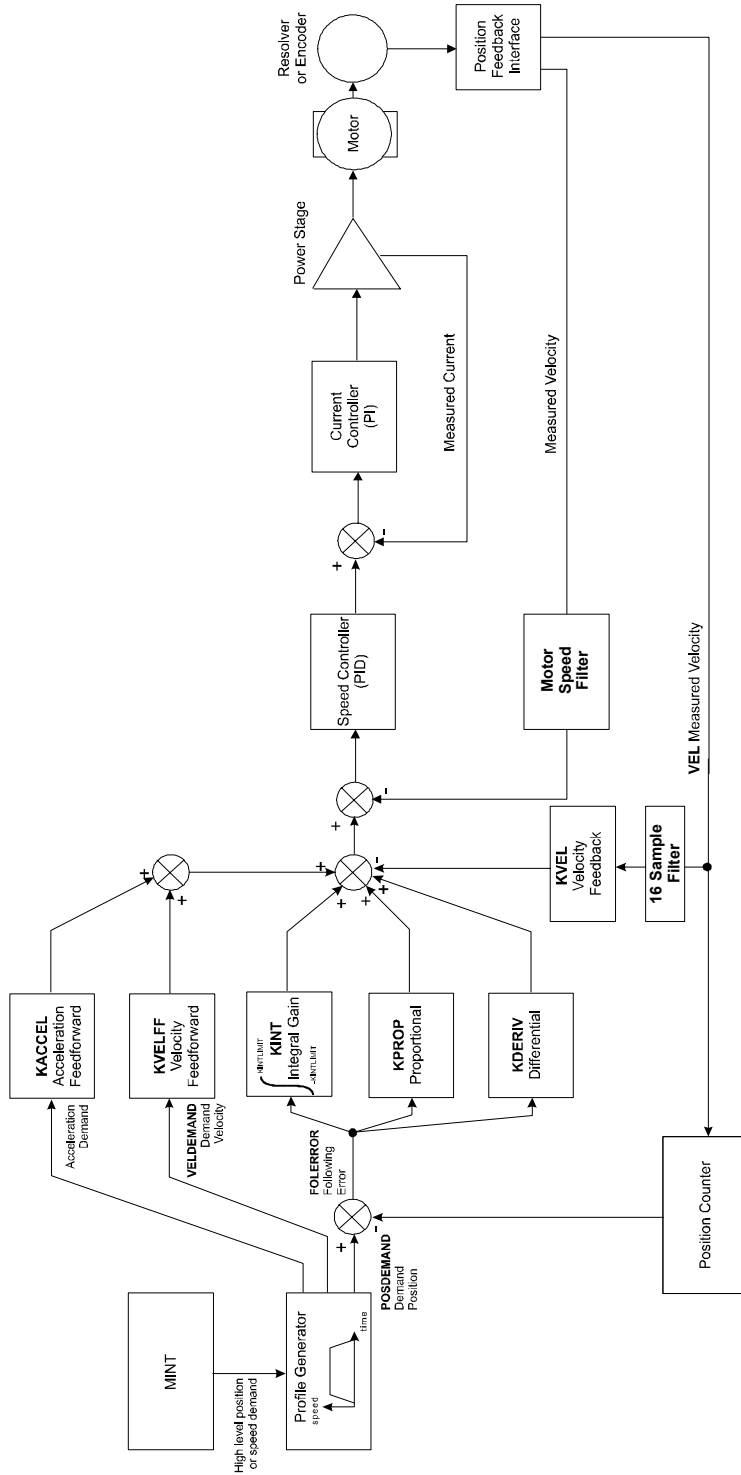

Figure A.1 MintDrive Closed Loop System

A.1.1 Closed loop control

It is possible that control could be achieved by applying a signal proportional to the position error alone, but this is a rather simplistic approach. If it is imagined that there is a small error between demanded and actual position, a proportional controller will simply multiply the error by a constant (the Proportional gain) and apply the resultant to the motor. If the gain is too high this may cause overshoot, which will result in the motor vibrating back and forth around the desired position. As the gain is increased, the MintDrive will present more resistance to positional error, but oscillations will increase in magnitude until the system becomes unstable. To reduce the onset of instability a damping term is incorporated in the servo loop algorithm, called velocity feedback gain. Velocity feedback acts to resist rapid movement of the motor and hence allows the Proportional gain to be set higher before vibration occurs. Alternatively, derivative gain (the derivative of the error) can be used for damping.

With Proportional gain and velocity feedback (or derivative action) it is possible for a motor at rest at a set point to exhibit a small positional error (called following error). The MintDrive multiplies the error by the proportional term to produce an applied corrective torque (in current control), but for very small errors the torque may not be large enough to overcome static friction. This error can be overcome by incorporating an integral term in the loop calculations. Integral action involves summing the error over time, so that motor torque is gradually increased until the positional error falls to zero. The speed at which integral action works is controlled by the integral gain. Integral action is useful to eliminate steady state positional errors, but will result in reduced dynamic response for the system. For this reason, a software selectable option `KINTMODE` is provided so that the user can select that the integrator is switched off during periods of constant velocity. With integral gain, it is possible for the output to wind up to 100% demand. This effect can be limited using the `KINTLIMIT` keyword which limits the effect of the integral gain at a defined percentage of the demand output.

The final term in the control loop is velocity feed forward. This is useful for increasing the response and reducing the following error, especially with velocity controlled servos.

In summary, the following rules can be used as a guide:

- **KPROP:** Increasing `KPROP` will speed up the response and reduce the effect of disturbances and load variations. The side effect of increasing `KPROP` is that it also increases the overshoot, and if set too high it will cause the system to become unstable. The aim is to set the Proportional gain as high as possible without getting overshoot, instability or 'hunting' on an encoder edge when stationary (the motor will buzz).
- **KVEL:** This gain has a damping effect, and can be increased to reduce any overshoot. If `KVEL` becomes too large it will amplify any noise on the velocity measurement and introduce oscillations.
- **KINT:** This gain has a de-stabilizing effect, but a small amount can be used to reduce any steady state errors. (By default, `KINTMODE` is set to ignore the `KINT` term).
- **KINTLIMIT:** The integration limit determines the maximum value of the effect of integral action. This is specified as a percentage of the full scale demand.
- **KVELFF:** This is a feed forward term and as such has a different effect on the servo system than the previous gains. `KVELFF` is outside the closed loop and therefore does not have an effect on system stability. This gain allows a faster response to demand speed changes with lower following errors, for example you would increase `KVELFF` to reduce the following error during the slew section of a trapezoidal move. The trapezoidal test move can be used to fine-tune this gain.
- **KDERIV:** This gain has a damping effect. The Derivative action has the same effect as the velocity feedback if the velocity feedback and feedforward terms are equal, but scaled by a factor of 16.
- **KACCEL:** This term is designed to reduce velocity overshoots on high acceleration moves. Due to the quantization of the positional data and the speed of the servo loop, for the acceleration feed forward term to affect the servo loop the acceleration of the axis must exceed 1,000,000 encoder counts per second.

In systems where precise positioning accuracy is required, it is often necessary to position within one encoder count. The Proportional gain is not normally able to achieve this because a very small following error will only produce a small demand for the amplifier which may not be enough to overcome mechanical friction (this is particularly so for current controlled systems). This error can be overcome by applying some integral gain. The integral gain, KINT, works by accumulating following error over time to produce a demand/command sufficient to move the motor into the zero following error position. KINT can therefore also overcome errors caused by gravitational effects, such as vertically moving linear tables, where with current controlled drives a non-zero demand output is required to achieve zero following error.

A.1.2 Position loop

The position loop uses a Proportional, Integral, Derivative, Velocity Feedback, Velocity Feed-forward and Acceleration Feed-forward (PIDVFA) algorithm. Every servo tick, the measured position and velocity are sampled. The profiler generates a new demand position, speed and acceleration according to the move type requested and the specified parameters (e.g. the acceleration and deceleration rates). Both the demanded and measured values are fed into the PIDVFA algorithm, which generates an input term (demand signal) to either the Speed loop or Current loop (depending upon the configuration). The PIDVFA algorithm is as follows:

$$Command = KP.e + KD.\left(\frac{\Delta e}{\Delta \tau}\right) - KV\left(\frac{v}{16}\right) + KF\left(\frac{V}{16}\right) + KI.\Sigma e + KA.A$$

where:

<i>KP</i>	Proportional position loop gain
<i>KD</i>	Derivative position loop gain
<i>KV</i>	Velocity feedback gain
<i>KF</i>	Velocity feed forward gain
<i>KI</i>	Integral gain
<i>KA</i>	Acceleration feed forward gain
<i>e</i>	Following error (quad counts)
τ	Servo update period (sample time)
<i>v</i>	Actual axis velocity (quad counts/sample time)
<i>V</i>	Demand axis velocity (quad counts/sample time)
<i>A</i>	Demand axis acceleration (quad counts/sample time ²)

Tuning the position loop involves selecting values for some or all of the terms KP, KD, KI, KV, KF and KA to provide the best performance for a particular motor/encoder combination and load inertia. In view of the diversity of applications, these values all default to zero.

A.1.3 Speed loop

The speed loop uses a Proportional and Integral (PI) algorithm. The PI algorithm is as follows:

$$\text{Command} = KVP.e + KVI.\Sigma e$$

where:

<i>KVP</i>	Proportional speed loop gain
<i>KVI</i>	Integral gain
<i>e</i>	Speed error

A.1.4 Current loop

The current loop uses a Proportional and Integral (PI) algorithm. The PI algorithm is as follows:

$$\text{Command} = KIP.e + KII.\Sigma e$$

where:

<i>KIP</i>	Proportional current loop gain
<i>KII</i>	Integral gain
<i>e</i>	Current error

A.1.5 MintDrive operational modes

The MintDrive can be configured to operate in 3 different modes:

- as a servo drive, where speed and position loops are active and the motion profiler produces a speed demand (CONFIG=1);
- as a velocity servo drive, similar to the servo drive configuration above (CONFIG=1) but only the Velocity Feedforward term KVELFF is used in the position loop;
- as a torque servo drive, where the speed loop is bypassed and the motion profiler produces a current demand (CONFIG=6).

These modes are selected using the Mint keyword CONFIG. The default is the servo drive mode, CONFIG=1 .

The loops are sampled at different rates:

- Current loop: 12.012kHz
- Speed loop: 8kHz
- Position loop: 1kHz (optionally configurable as 500Hz and 2kHz).

A.1.6 Tuning the position loop for a velocity servo drive

The MintDrive can be tuned as a velocity servo drive, passing the profiled demand components through the speed and current loops only. To do this the MintDrive keyword `CONFIG` should be set to 1 by typing:

```
CONFIG=1
```

The gain term `KVELFF` should be set to the value derived from the following equation:

$$KVELFF = (32767 / (((MaxMotorSpeed / 60) / Servo Frequency) \times (4 \times MotorEncoderLines))) / 16$$

where:

Servo Frequency is the reciprocal of the time period set using the Mint keyword `LOOPTIME`;
MotorEncoderLines is 1024 for a resolver motor;
MaxMotorSpeed is found from the motor specifications.

A.1.7 Tuning the position loop for a servo drive

The MintDrive can be tuned as a servo drive, passing the profiled demand components through the position, speed and current loops. To do this the MintDrive keyword `CONFIG` should be set to 1 by typing:

```
CONFIG=1
```

There are two types of move that can be used to help tune the position loop; step and trapezoid. A step move performs an instantaneous position demand change. This is useful for tuning the motor to overcome following error and decrease response time.

The trapezoid move type performs a trapezoidal move based on a given acceleration, slew speed and deceleration profile. This is equivalent to a positional move generated by using the keywords `MOVEA` or `MOVER`.

A.1.7.1 Position Loop gain terms

The output from the position loop is effectively a speed command. This command is a 16-bit signed value scaled such that 32767 represents the maximum motor speed.

Before starting, it may be necessary to increase the Following Error Fatal limit, the threshold at which the drive will trip with a Following Error. The default value is 1000 counts which may not be sufficient whilst initially tuning the motor.

KVELFF - Velocity Feedforward gain

This is applied to the demand speed. The profiler will generate a demand speed based upon the current move. This term should be used to scale that demand speed to the equivalent speed command for the speed loop - this is related to the specified maximum speed of the motor and of the position (servo) loop frequency:

The gain term `KVELFF` should be set to the value derived from the following equation:

$$KVELFF = (32767 / (((MaxMotorSpeed / 60) / Servo Frequency) \times (4 \times MotorEncoderLines))) / 16$$

where:

Servo Frequency is the reciprocal of the time period set using the Mint keyword `LOOPTIME`;
MotorEncoderLines is 1024 for a resolver motor;
MaxMotorSpeed is found from the motor specifications.

Click on the Position Loop tab and enter the calculated value for `KVELFF`.

KPROP - Proportional gain

This is applied to the Following Error. This should be used to overcome any lag in the system response and to remove any final following error. Increasing this gain will improve the response of the system and reduce following error. The side effect of increasing this gain is that it also increases overshoot, and if set too high will cause the system to become unstable.

The speed increase (per servo loop) resulting from the term `KPROP` can be calculated from;

$$\text{Speed increase} = KPROP \times FOLERROR / KVELFF$$

where:

FOLERROR is the following error expressed in counts

As an example, for a following error of 100 counts with `KPROP = 2`, the commanded speed would be increased by 46.72 counts/tick, for a resolver motor with `MaxMotorSpeed = 7000 RPM`.

Click on the Position Loop tab and enter 1 as an initial value for `KPROP`.

KVEL - Velocity Feedback gain

This is applied to the Measured Speed. This term has a damping affect and can be used to reduce any overshoot. If the gain gets too large it will amplify any noise on the velocity measurement and introduce oscillations. Click on the Position Loop tab and enter 0 as an initial value for `KVEL`.

KINT - Integral gain

The integral term `KINT` can be used to overcome steady-state errors. Only small values should be used otherwise the term will have a de-stabilizing affect. By default the integral term is turned off, but it can be turned using the Mint keyword `KINTMODE`. Two modes are supported, one in which the integral will be applied throughout a move (`KINTMODE=1`), and another which will only apply it through constant speed (`KINTMODE=2`). `KINT` can also be affected by defining the integration limit using the Mint keyword `KINTLIMIT`. In Mint WorkBench, type:

```
KINTMODE=2          in the Terminal window.
```

Click on the Position Loop tab and enter 0 as an initial value for `KINT` and 20 as an initial value for `KINTLIMIT`. (If you are using the Mint Configuration Tool, enter 0 in the `KINT` box).

KDERIV - Derivative gain

This is applied to the change in Following Error. This term will speed up the response to the initial change in demand and reduce overshoot. This can be used to control any overshoot given using `KPROP` on a step response. Click on the Position Loop tab and enter 0 as an initial value for `KDERIV`.

KACCEL - Acceleration Feedforward gain

This is applied to the demand acceleration. This term has the affect of reducing following error during high acceleration and deceleration phases of a move. This term can only be set in Mint WorkBench in the Terminal window.

A.1.7.2 Position Loop Tuning using a step move

In the Move Type box select Position Step and select a reasonably small step change. For example start with a position step change equivalent to 100 counts. Remember that the value entered here is in "user units" and will therefore be scaled by the scale factor you entered earlier.

With only KVELFF set, you will get very little response. Since the step move demands an instantaneous change in demand position, the demand speed will only last for one servo tick. The speed loop alone will not be sufficient to achieve the position step change. The Proportional gain term KPROP should be used to overcome the following error. Start with a small for of KPROP, for example 1

This will start to achieve the demanded position. As the value of KPROP increases, so will the rise (response) time. As KPROP is increased further, eventually either an overshoot or ringing will occur. Both these factors can be reduced by introducing a value for the damping terms KVEL and KDERIV.

The Step Response Statistics tab can be used to analyze the response to the step move:

A.1.7.3 Position Loop Tuning using a trapezoidal move type

Select the 'Move Type' as Position Trapezoid and select a move profile (acceleration, deceleration and slew speed) to reflect the typical move your application will use. Remember that the values entered here are in "user units" and will therefore be scaled by the scale factor you entered earlier.

With only KVELFF set there will be a resultant Following Error at the end of the move. Start increasing the value of KPROP and repeat the move. Increasing the value of KPROP should allow the following error through the slew period and at the end of the move to be almost eliminated. During the acceleration and deceleration phases, the following error will be greater. This following error will increase in relation to any increase in the acceleration or deceleration rates.

The KACCEL term can be applied to reduce the following error during the acceleration and deceleration rates. This term can only be set in Mint WorkBench in the Terminal window.

A.1.8 Tuning the position loop for a torque servo drive

The MintDrive can be tuned as a torque servo drive, passing the profiled demand components through the position and current loops only. To do this the MintDrive keyword `CONFIG` should be set to 6 by typing:

```
CONFIG=6
```

You should have already tuned the current loop and speed loop, but in this mode of operation the speed loop gains are disregarded. The value of `KPROP` should be set to a small value when operating the controller as a torque servo drive - a starting value of 0.5 is suggested.

Increase `KVEL` until the motor shaft becomes stiff to turn. Use WorkBench to perform test moves and monitor results. If `KVEL` is increased too much, instability will occur.

Typically, `KVELFF` is found to be close to `KVEL` when operating the controller as a torque servo drive, so set `KVELFF` to the same value as `KVEL`.

Values for the terms `KINT`, `KDERIV` and `KACCEL` can be found by applying the principles for tuning the motor as servo drive. See section A.1.7 on page 102.

A.1.9 Saving tuning information

The speed loop and current loop gains are stored in the controller's battery backed memory, but the position loop gains are not. It is recommended that all of these parameter settings are placed in your application's Configuration file so that the MintDrive can be re-configured after each power-cycle or if it is replaced.

B.1 Outline

This section provides an introduction to the CAN (Controller Area Network) peripherals and how these are configured to operate with the MintDrive.

B.1.1 MintDrive capabilities

The MintDrive can communicate with I/O expansion modules or other Mint v4 controllers via CAN, and is compatible with DS-301, version 4 (*Application Layer and Communication Profile*) and mandatory sections of DS-401, version 2 (*Device Profile for Generic I/O modules*). Some parts of DS-403, version 1 (*Device Profile for Human Machine Interfaces*) are also supported. When connecting third party devices please contact Baldor if you are unsure about compatibility.

CAN offers serial communications over a two wire twisted pair cable up to a maximum of 1640ft (500m) in length, and offers very high communication reliability in an industrial environment; the probability of an undetected error is 4.7×10^{-11} . The default transmission rate is 125Kbaud although higher rates up to 1000Kbaud can be selected.

CAN is optimized for the transmission of small data packets and therefore offers fast update of I/O devices (peripheral devices) connected to the bus. Several CAN peripheral devices may be attached to the same controller via the CAN link using the CAL protocol. Up to 63 mixed type CAN peripherals may be connected to the MintDrive CAN network, with the limitation that only 4 enabled keypads are allowed at one time.

On the MintDrive, connection to the CAN networks are made using a 9-pin male D-type connector for CAN bus channel 1 (CANopen) and a shielded RJ45 type connector for CAN bus channel 2 (Baldor CAN). Both CAN channels are isolated. When MintDrive is at the end of a CAN network, the terminator for that channel must be activated. The terminators are activated by setting the DIP switch on the front panel to ON. Each CAN channel has its own DIP switch and terminator.

A very low error rate over CAN can only be achieved with a suitable wiring scheme, so the following points should be observed:

- CAN must be connected via twisted pair cabling to reduce RF emissions and provide immunity to conducted interference. The connection arrangement is normally a simple multi-point drop. The CAN cables should have a characteristic impedance of 120Ω and a delay of 5ns/m. Other characteristics depend upon the length of the cabling:

Cable length	Maximum bit rate	Resistance	Conductor area
0ft ~ 131ft (0m ~ 40m)	1000Kbaud	<70m Ω /m	0.25-0.34mm ²
131ft ~ 984ft (40m ~ 300m)	500Kbaud	<60m Ω /m	0.34-0.60mm ²
984ft ~ 1968ft (300m ~ 600m)	100Kbaud	<40m Ω /m	0.50-0.60mm ²
1968ft ~ 3280ft (600m ~ 1000m)	50Kbaud	<26m Ω /m	0.75-0.80mm ²

-
- Terminators must only be fitted at both ends of the network, not at intermediate nodes.
 - The 0V rails of all of the nodes on the network must be tied together through the CAN cabling. This ensures that the CAN signal levels transmitted by MintDrive or CAN peripheral devices are within the common mode range of the receiver circuitry of other nodes on the network.

MintDrive supports the full range of Baldor CAN peripherals - InputNode 8, OutputNode 8, RelayNode 8, ioNode 24/24 and KeypadNode.

B.2 CAN 1 (CANopen)

This section provides an introduction to CANopen peripherals and how they are configured to operate with the MintDrive.

B.2.1 CAN 1 (CANopen) - X9

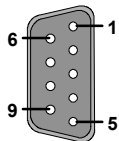
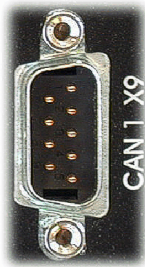

Location	Connector X9		
	Pin	Name	Description
	1	-	Not connected
	2	CAN1-	CAN channel 1 negative
	3	CAN1 0V	Ground/earth reference for CAN signals
	4	-	Not connected
	5	Shield	Cable shield
	6	-	Not connected
	7	CAN1+	CAN channel 1 positive
	8	-	Not connected
	9	CAN1 V+	CAN remote node power V+ (12-24V)
Description	CANopen interface using a 9-pin female D-type connector with CiA standard DS102 pin configuration		

CAN1 is opto-isolated and is intended for use as the machine-wide fieldbus using the open protocol CANopen. Practical operation of this CAN channel is limited to 500Kbaud owing to the propagation delay of the opto-isolators.

Correct operation of CAN1 can only be achieved with screened/shielded twisted pair cabling.

CAN1+ and CAN1- must form a twisted pair with the shield connected to the connector backshell.

CAN1 must be terminated by a 120Ω resistor connected between CAN1+ and CAN1- at both ends of the network and nowhere else.

If the MintDrive is at the end of the network then ensure that the CAN1 DIP switch (located on the front panel) is in the ON position, which will connect an internal terminating resistor. A convenient way of wiring a chain of devices is by using a T-connector.

Note: The CAN1 port must be powered with a DC voltage in the range 12-24V.

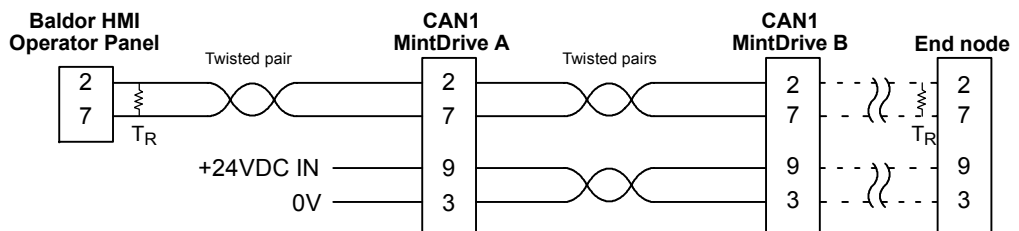

Figure 28 - Typical MintDrive CAN1 network connections

B.2.2 What is CANopen?

CANopen is a networking system based on the serial bus CAN. It uses the international CAN standard, ISO 11898 as the basis for communication. The MintDrive implements the CANopen Communication Profile (CiA DS-301) in Mint v4, which supports both direct access to device parameters and time critical process data communication. The MintDrive also supports a number of third-party I/O devices and HMI (Human Machine Interface) operator panels. Each type of device has been assigned a unique node type number that is used to identify it on the network.

Type	Mint Constant	Node Type	
Bitmap value	0	_ntNONE	Not present
	1	_ntANALOG_IN	Analog Input module (third-party)
	2	_ntANALOG_OUT	Analog Output module (third-party)
	4	_ntDIGITAL_IN	Digital Input module (third-party)
	8	_ntDIGITAL_OUT	Digital Output module (third-party)
21	_ntNEXTMOVE_BX	Controller (Baldor)	
22	_ntNEXTMOVE_PCI	Controller (Baldor)	
30	_ntSERVONODE51	Controller (Baldor)	
32	_ntMINTDRIVE	Controller (Baldor)	
41	_ntOPERATOR_PANEL	HMI operator panel (Baldor)	

A third-party CANopen I/O node may have a combination of analog and digital I/O modules. The node type for such a node is a bitmap of the type of modules present, resulting in a node type between 1 and 15. The Baldor controller nodes are connected together over CAN to form a peer-to-peer network. Lines of communication between these nodes exist in the form of singlecast and broadcast messages via the comms array. The I/O nodes and HMI operator panels are connected via CAN and are then assigned to a single Baldor controller node that then has full control over the node's data (I/O). Due to memory limitations there is a limit to the number of nodes that can be present on the CAN 1 Bus:

- A maximum of 63 Baldor controller nodes can be on the bus at the same time.
- A maximum of 20 CANopen I/O nodes with full digital and analog I/O functionality can be on the bus at the same time.

If the I/O nodes have a reduced function set then a greater number of nodes may be supported.

If support for a greater number of nodes is required on the CAN 1 Bus, please contact Baldor Technical Support for more information.

B.2.3 Configuring nodes

A node must be assigned a unique node number. On Baldor controllers, the node number and CAN baud rate can be set using the `NODE` and `CANBAUD` Mint keywords. For example the following commands change the controller's node number to 12 and the baud rate to 500Kbaud:

```
NODE = 12
CANBAUD.1 = 500
```

Note: Note that third-party I/O nodes will have a specific method for setting their node number and CAN baud rate. Please refer to the manufacturer's instructions.

The MintDrive stores its node number and CAN baud rate in non-volatile memory so that each time it is powered, the basic CAN configuration is automatically setup.

B.2.4 Network manager - node 1

On the CAN1 network there must be a device with node number 1. This node is called the *network manager* node because it performs supervisory tasks that ensure the network operates correctly. These include:

- NMT Master tasks - This includes initialization of NMT slaves that are to be added to the bus during a node scan, supervision of node status via nodeguarding and supervision of the bus status.
- SDO Manager - Setting up and maintaining a list of all connections that are active between nodes (comms array links and groups).
- Configuration Manager - Upload/download of configuration data to/from a node on the network during a node scan.

If node number 1 is being used to manage a network with a large number of nodes, it is advisable that it is not used to control motion on its local axis/axes. The node should act simply as a gateway from the host computer to the networked controllers, maintaining all network connections and reporting all node/bus events.

B.2.5 Scanning nodes

The first step in creating a CANopen network is to find and identify the nodes that exist on the CAN bus. This is achieved by using the `NODESCAN` command on the network manager node.

The controller can find all nodes that exist on the bus by passing zero as the node parameter:

```
NODESCAN.1.0      where 1 is the CAN bus,
```

or the user can request the network manager to scan for individual nodes by passing the node number as the node parameter:

```
NODESCAN.1.2
```

The `VIEW NODELIVE` command can be used on the network manager to get a summary of the nodes that have been detected by the scan.

Alternatively, the `NODELIVE` and `NODETYPE` keywords can be used within a Mint program to return the same information. The following commands will get information about node 2:

```
? NODELIVE.1.2
? NODETYPE.1.2
```

When a node has been successfully scanned it can be removed from the bus by setting the node type for that node to zero. For example, the following command will remove node 2 from CAN bus 1:

```
NODETYPE.1.2 = 0
```

B.2.6 Connecting to nodes

Device parameters and data are stored in a reserved area of memory called the Object Dictionary. Once a node has been scanned by the network manager, the next step is to make a connection to that node to allow data from the node's Object Dictionary to be accessed. This also puts the node into the *operational* state.

However, there are differences when making connections to Baldor controller nodes or third-party I/O nodes. By default, when the network manager successfully detects that a Baldor controller node has become live (has been successfully scanned), it will automatically establish a connection to the controller by performing the command:

```
CONNECT.1.n = 1    where n is the node number.
```

This allows the network manager node to automatically access the comms array of live controller nodes over CAN. If the user wants a controller node *n* to access the comms array of the network manager node, a connection must be manually made in the reverse direction, on the network manager node:

```
C001>CONNECT.n.1 = 1
```

For third-party I/O nodes an automatic connection is not made so the commands have to be manually issued, for example:

```
C001>CONNECT.1.n = 1
```

Until this connection has been made, a controller node will not be able to access an I/O node using Mint keywords, meaning you will not be able to read inputs and set outputs. Making the connection puts the I/O node into its *operational* state. Once the I/O node has been connected to a Baldor controller node it will not be possible to connect it to another node at the same time.

The `VIEW CONNECT` command can be used on the network manager to get a summary of the connections that have been made, or information on any other controller node to find what connections it has. The network manager can also break a connection to a node so that access to the remote data from the node's Object Dictionary is removed. For example, the following command will remove the connection between node 2 and the network manager node:

```
CONNECT.2.1 = 0
```

Connection information can also be viewed in the CAN window in Mint WorkBench.

B.2.7 Monitoring CAN events

When a node's status changes (live or dead for example), it will generate a CAN message to inform the network manager of the change. The network manager will then generate a Mint event. The type of events that are supported on the CAN bus 1 are listed below:

Event Number	Mint Constant
0	_cetNONE
1	_cetBUS_OPERATIONAL
2	_cetBUS_PASSIVE
3	_cetBUS_OFF
4	_cetRECEIVE_OVERRUN
5	_cetDIED
6	_cetLIVE
7	<i>Reserved</i>
8	<i>Reserved</i>
9	<i>Reserved</i>
10	<i>Reserved</i>
11	_cetEMERGENCY
12	_cetUNIOP_COMMS_UPDATE
13	_cetTRANSMIT_OVERRUN

These events are buffered until they are read using the `CANEVENT` keyword. When one or more events are held in the buffer the Mint CAN event handler (subroutine) for bus 1 will be called (`#CAN1`) if it exists. The `CANEVENT` and `CANEVENTINFO` keywords should be used in this subroutine to determine which event has occurred and its associated information.

```
#CAN1
  ? "CAN bus 1 : Event ",CANEVENT.1,
  ? " occurred with info ",CANEVENTINFO.1,"."
RETURN
```

Alternatively, the `VIEW CANEVENT` command can be used at the Mint command line to continuously monitor the CAN bus for events:

```
C001>VIEW CANEVENT.1
```

The act of reading `CANEVENT` and `CANEVENTINFO` will remove the event from the buffer, so the next time the subroutine is called the following event will be read. CAN events can also be monitored using the CAN window in Mint WorkBench.

B.2.8 Controller nodes

Each controller node on the network contains its own comms array, which provides a convenient method of transferring data between controller nodes on the bus. The meaning of the data, which is passed between the controllers is determined by the application (Mint) program.

For further details on the comms array please refer to the *Mint v4 Programming Guide*.

B.2.8.1 Singlecast communication

The advantage of the comms array when accessed over the CAN network is that a link can be established so that a controller can read from and write to another controller's comms array. After the link has been established using the network manager, the two nodes can communicate without further intervention from the network manager.

For example, the following command would need to be issued on the network manager to create a link so that node 7 could read from and write to the comms array on node 23:

```
CONNECT.7.23 = 1
```

The `CONNECTSTATUS` keyword can be used on the slave node to check that its link to node 23 is valid before it is used:

```
PAUSE CONNECTSTATUS.23=1
```

For node 7 to access its own comms array (index 5 for example) the following commands can be used:

```
COMMS(5) = 6      to write a value  
v = COMMS(5)     to read a value.
```

To access the comms array (index 5) on the remote controller node (node 23), via the CAN bus, the following commands can be used:

```
COMMS(23,5) = 6  to write a value  
v = COMMS(23,5) to read a value.
```

B.2.8.2 Broadcast communication

The second method of accessing the comms arrays over CAN allows a group master node to write to a comms array location of a group of nodes. Each group must have a master node and any node may be in any number of groups. Grouping is set up using the `GROUPMASTER` keyword, for example:

```
GROUPMASTER.3 = 15      would set node 15 to be the group master of group 3.
```

To allow a node to receive a group write broadcast the `GROUP` keyword is used on the network manager. The following commands would allow nodes 2 and 23 to receive the group write broadcasts for group 3:

```
GROUP.3.2 = 1  
GROUP.3.23 = 1
```

The group master node can check if it has been made the group master by using the `GROUPMASTERSTATUS` keyword. This command will return 1 when the node on which it is issued has been made the group master, for example:

```
PAUSE GROUPMASTERSTATUS.3
```

On the group master node (node 15 for example), the `GROUPCOMMS` command is used to access the comms array of all nodes in that group. The following command would write the value 4 to location 30 of all the nodes that are in group 3:

```
GROUPCOMMS(3,30) = 4
```

The `VIEW GROUP` instruction can be used on the network manager to get a summary of the groups that have been set up, or on a slave node to see the groups in which it is a member/master.

B.2.8.3 Comms array subroutines

The `#COMMS` subroutine allows a program to be interrupted when its comms array has been updated by a comms array write from another node, over CAN. For example, if a node defines its local comms array element 5 as a target position, the following subroutine triggers a move each time this element is updated by a remote node:

```
#COMMS5
MOVEA.1 = COMMS(5)
GO.1
RETURN
```

The `#COMMS` subroutine will also be triggered if the local comms array element is updated over RS232 or DPR (Dual Port RAM), if these interfaces exist on the controller. The comms locations `COMMS(1)` to `COMMS(5)` are mapped to subroutines `#COMMS1` to `#COMMS5`.

B.2.9 I/O nodes

A variety of third-party I/O nodes are available that include devices with fixed configuration (a fixed number of analog outputs) and devices that are flexible in their configuration (have a number of different types of I/O modules connected via a bus coupler). Provided the node conforms to the CANopen Device Profile for Generic I/O Modules (DS-401), it should be fully compatible with the Baldor range of controllers. The following sections describe the Mint keywords that can be used to read and write data to these devices.

B.2.9.1 Digital I/O access

Digital inputs and outputs have two possible states; ON and OFF. Mint allows for two methods of reading from and writing to digital I/O on a CANopen node.

The first method uses the `REMOTEIN` and `REMOTEOUT` keywords and accesses all of the inputs/outputs. The value that is read from or written to the node is simply a bitmap of the inputs/outputs and can be written in any of the base formats supported in Mint (binary, decimal or hexadecimal). For example:

```
? REMOTEIN.1.2      will read the state of all of the inputs on node 2.
```

The command:

```
? REMOTEOUT.1.2     will read the state of all of the outputs on node 2.
```

Similarly:

`REMOTEOUT.1.2 = 255` will set the state of all of the outputs on node 2 to 255 decimal.

The second method uses the `REMOTEINX` and `REMOTEOUTX` keywords and accesses individual inputs or outputs. Each input/output can either be ON (1), or OFF (0).

For example:

? `REMOTEINX.1.2.0` will read the state of input 0 on node 2.

The command:

? `REMOTEOUTX.1.2.0` will read the state of output 0 on node 2.

Similarly,

`REMOTEOUTX.1.2.0 = 1` will set the state of output 0 on node 2 to ON ('1').

B.2.9.2 Analog I/O Access

Analog inputs and outputs can have any value between 0 and 100. This value will represent a voltage equal to the specified percentage of the full-scale voltage; please see the manufacturer's instructions.

For example:

? `REMOTEADC.1.2.0` will read the value of analog input channel 0, on node 2.

The command:

? `REMOTEDAC.1.2.3` will read the value of analog output channel 3, on node 2.

Similarly,

`REMOTEDAC.1.2.3 = 100` will set the value of analog output channel 3, on node 2, to 100.

B.2.9.3 Extra Analog I/O Functionality

Mint provides some extra functionality with analog input nodes. The value of an analog input will often change constantly. This can cause a lot of CAN 'traffic' to be generated if the node is event driven because the node will generate a CAN message every time the input changes. The `REMOTEMODE` keyword is provided in Mint to allow the user to set the analog node to either Event (0) or Cyclic (1) mode. Setting it to Cyclic mode will force the node into generating CAN messages on a cyclic basis, in synchronization with a SYNC message that is generated by the network manager. This will help reduce CAN traffic and also allow the user to predict the level of activity on the CAN bus more easily. The following example will set the analog input channels of node 2 to Cyclic mode:

`REMOTEMODE.1.2 = 1`

Running in Event mode will cause a CAN message to be generated every time the input changes.

The Mint keyword `REMOTEOADCDELTA` can also be used to reduce the amount of CAN traffic. This keyword allows the user to specify an amount by which an analog input must change (delta) before a CAN message is generated. The value used will depend on the type of node; please refer to the manufacturer's instructions. This function can be used if the node has been set to 'Event' mode using the `REMOTEMODE` keyword.

The following example code will set the delta interrupt for analog input 3 on node 2, to 100:

```
REMOTEOADCDELTA.1.2.3 = 100
```

B.2.10 HMI Operator Panels

Baldor produce a range of HMI (Human Machine Interface) operator panel nodes which, when fitted with an optional CANopen driver card, can be fully exercised by a Baldor controller node over CANopen. The software in the CANopen driver uses a communication protocol based on the CANopen device profile for Human Machine Interfaces (DS-403). The types of HMI available range from a simple low cost device with a 4x20 character display and 10 keys, to a powerful touchscreen device with a 16x40 character VGA graphical display.

All of the HMI operator panels use the same CANopen interface for communications which is very similar to the singlecast communication described for Baldor controllers. Communication between a Baldor controller and a HMI operator panel is achieved via the comms array in the HMI. This comms array consists of the following:

- 254 x 32-bit integer variables
- 254 x IEEE floating point variables.

Using the HMI Operator Panel design software used to create the character/graphical layout for the HMI display, these two groups of variables appear as two separate databases (`INT32_DB` and `FLOAT_DB` respectively), using an index between 0h and FEh to access the individual variables. When accessing these variables from a Baldor controller they appear as contiguous elements of the device's comms array.

Data format	HMI database variable	HMI variable index	Baldor comms index
32-bit integer	INT32_DB	1 ~ FEh	1 ~ 254
IEEE floating point	FLOAT_DB	1 ~ FEh	255 ~ 508

For example, if the HMI panel were to be configured as CANopen node 30, the `COMMS` keyword could be used to access the HMI data as shown:

```
COMMS(30,1) = 100           will set the 32 bit integer variable at index 1 to 100
COMMS(30,255) = 10.23      will set the float variable at index 255 to 10.23
? COMMS(30,1)              will read the 32 bit integer variable at index 1
? COMMS(30,255)            will read the float variable at index 255.
```

Note: It is useful to note that even though the comms array is being used to access data on the HMI, the data is only stored on the HMI itself and is completely unrelated to the data stored in the comms array on the Baldor controller.

In addition to being able to set data on the HMI from a Baldor controller, the HMI panel can set its own data, the nature of which is determined when the user designs their own HMI project using the HMI Operator Panel design software.

The HMI communicates its own changes to the MintDrive using CAN event 12 (`_setUNIOP_COMMS_UPDATE`). This event will initiate the Mint CAN event handler (subroutine) `#CAN1`, and the associated CAN event information read using `CANEVENTINFO` will inform the user which HMI comms location has changed. The `COMMS` keyword can then be used to read the new data if required. Alternatively, the MintDrive can poll the comms data stored in the HMI to determine if it has changed. The HMI allows the data to be stored in its databases in the following formats:

INT32_DB		FLOAT_DB	
Bit	1 bit	Float	4 bytes - IEEE format
Byte	8 bits / 1 byte	Float Inv.	4 bytes - IEEE format
Word	2 bytes		
Word Inv.	2 bytes		
Double Word	4 bytes		

B.3 CAN 2 (Baldor CAN)

B.3.1 CAN 2 (Baldor CAN) - X8

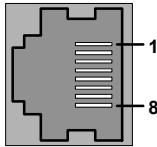
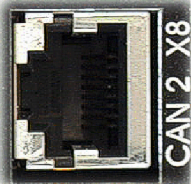

Location	Connector X8		
	Pin	Name	Description
	1	-	<i>Not connected</i>
	2	-	<i>Not connected</i>
	3	-	<i>Not connected</i>
	4	CAN2 0V	Ground/earth reference for CAN signal
	5	CAN2 V+	CAN remote node power V+ (12-24V)
	6	-	<i>Not connected</i>
	7	CAN2+	CAN channel 2 positive
	8	CAN2-	CAN channel 2 negative
Description	Baldor proprietary CAN interface using a RJ45 connector.		

CAN2 is opto-isolated and is intended for use with Baldor's ioNode family of CAN peripherals. Practical operation of this CAN channel is limited to 500Kbaud owing to the propagation delay of the opto-isolators.

Correct operation of CAN2 can only be achieved with screened/shielded, twisted pair cabling. CAN2+ and CAN2- must form a twisted pair with the shield connected to the connector backshell. CAN2 must be terminated with a 120Ω resistor connected between CAN2+ and CAN2- at both ends of the network and nowhere else.

If the MintDrive is at the end of the network then ensure that the CAN2 DIP switch (located on the front panel), is in the 'ON' position, which will connect an internal terminating resistor.

The CAN2 port must be powered with a DC voltage in the range 12-24V. This can be achieved by powering an ioNode family device. Note that on the ioNode jumpers JP1 and JP2 must be in the CAN Bus 2 position as this selects pins 7 & 8 for CAN traffic.

B.3.2 Preparing the MintDrive

Termination resistors must be fitted at each end of the network to reduce signal reflection. The MintDrive is fitted with a termination resistor for this purpose.

On the front panel of your MintDrive the termination resistor should be selected by setting the CAN2 DIP into the ON position.

B.3.3 Preparing the CAN peripheral

Termination resistors must be fitted at the ends of the network to reduce signal reflection.

The CAN peripheral is fitted with a termination resistor for this purpose.

If the CAN peripheral is at the end of the CAN network, the termination resistor can be selected by fitting a jumper to JP3.

Also, when connecting a CAN peripheral to a MintDrive controller, the peripheral's CAN Bus channel 2 must be selected by fitting jumpers JP1 and JP2 to position 2.

Jumpers JP4 and JP5 should not be fitted at this stage.

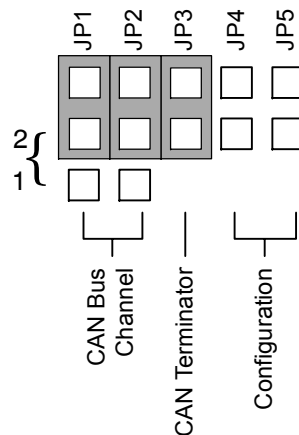

B.3.4 Connecting the PC, MintDrive and CAN peripheral

Connect the CAN peripheral to the MintDrive using a suitable CAN cable. Connect the CAN peripheral to a 24VDC supply.

If it is not already connected, connect the MintDrive to the PC using a suitable RS232 cable. Power up the PC and the MintDrive.

Start Mint WorkBench and open the Terminal window (CTRL+T).

Press the Enter key to display the `C>` prompt. If the prompt does not appear, press CTRL+E. This will end any program that might be running on the MintDrive.

B.3.5 Node IDs

Each CAN peripheral must be given a unique “node ID” within the network. The node ID, which is just a number, is used to ensure that a node only responds to messages intended for it. The node ID does not have to reflect the order in which the nodes are physically connected in the network.

CAN peripherals have a default node ID as shown in the table below, but they can be assigned any node ID between 1 and 63. This can be done in Mint WorkBench using a method called static configuration and is essential if two peripherals of the same type are installed.

Node type	Type	Mint Constant	Default Node ID	Default Baud rate
Not present	0	_ntNONE	-	125
8 digital input node	1	_ntINPUT_NODE_8	1	125
8 digital output node	2	_ntOUTPUT_NODE_8	7	125
8 relay output node	3	_ntRELAY_NODE_8	7	125
<i>Reserved</i>	4 ~ 7	-	-	-
ioNode 24/24	8	_ntIIONODE24_24	8	125
KeypadNode	9	_ntKEYPAD	14	125

B.3.6 Static configuration

To perform static configuration of a CAN peripheral, it is essential that no other nodes are connected to the CAN network. Only the MintDrive and the peripheral to be configured should be connected.

In addition to jumpers JP1, JP2 and JP3, jumpers JP4 and JP5 must be fitted for configuration.

The LED on the CAN peripheral should be red.

In the Terminal window, type:

```
REMOTESETUP
```

Mint will respond with the current details of the node, followed by a prompt for the new node ID number. For example, if the CAN peripheral is an InputNode 8, you will see a message similar to:

```
Node Type = inputnode8
Current Node Number = 5
Serial Number = 00000000148420
Firmware Version = 1.00.b4
```

```
New Node Number ?
```

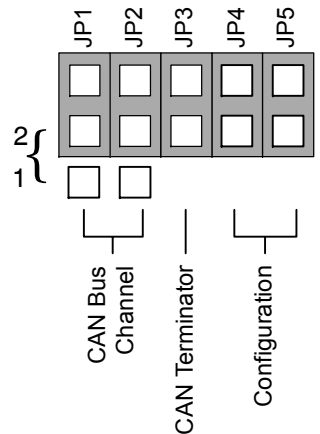

Type a number between 1 and 63, followed by the Enter key. This will tell the node its new node number. Remember to choose a number that no other node will be using.

A prompt for the CAN Baud rate will be shown.

```
New CAN Baud ?
```

Type a valid Baud rate (in Kbaud), for example 125.

Note: The CAN baud rate is the rate at which data is transferred over the network. The controller and CAN peripherals use a default CAN transmission rate of 125Kbaud. Although it is possible to alter this it should not be necessary so enter a value of 125.

When the node has been configured successfully WorkBench will display the message:

```
Remote Node is set.
```

Power down the CAN peripheral.

Remove jumpers JP4 and JP5.

B.3.7 Adding the node to the network

Now that the peripheral has been given its unique node ID, it can be added to the network. For example, assuming a RelayNode 8 has been statically configured to node number 7 type:

```
NODETYPE.7 = _ntRELAY_NODE_8
```

This tells Mint that node number 7 is a RelayNode8 peripheral. The term `_ntRELAY_NODE_8` is called a Mint constant.

Alternatively, you could have typed the line:

```
NODETYPE.7 = 3
```

This is because in addition to the Mint constant, the RelayNode 8 also has a type number of 3. The table in section B.3.5 on page 121 shows the Mint constants and type numbers for various peripherals.

The LED on the RelayNode8 will start to flash green, approximately once every half second. Each flash indicates that the RelayNode8 is participating in CAN activity.

Note: Each time a CAN Peripheral is added, a *node live* event occurs.

B.3.8 Monitoring CAN Bus communications

CAN Bus communications can be monitored in real-time using Mint WorkBench. To monitor CAN Bus communications, type:

```
VIEW CANEVENT
```

All events and errors on the CAN Bus will be reported. To stop monitoring CAN events, press CTRL+E.

To confirm that the MintDrive is able to communicate with RelayNode8, you can test to see if the node is “live”. Press CTRL+E to stop CAN Bus monitoring, then type:

```
? NODELIVE.7
```

The ? means “print on the screen”. Mint will return the value 1 (true) confirming the node with ID 7 is live. If a 0 (false) is returned it means the node is not live and there is a problem with communication.

To list all the present nodes together with their type and if they are live, type:

```
VIEW NODELIVE
```

Live on Node 7 will have been abbreviated to L and the outputs are now free to be controlled.

B.3.9 Controlling the CAN peripheral

To test the peripheral, you may wish to try the following commands. For example, if you have connected a RelayNode 8, try the following test. Type:

```
REMOTEOUTX.7.3 = 1
```

This will set node 7, output 3 to 1 (on or true).

B.3.10 Normal operation

When involved in CAN communication the status LEDs on the CAN peripherals flash green.

The MintDrive operates a node guarding procedure in which all nodes are regularly sent a CAN message. This action is shown on the CAN peripheral by the green LED flashing approximately once every half second.

B.3.11 KeypadNode

The KeypadNode provides a general purpose interface suitable for standalone machines of all types. It is a cost effective solution for simple functions such as replacing thumb wheel switches and providing simple diagnostics. It can also be used as a fully interactive programming panel for machine control. Features include:

- High speed CAN bus connection
- 20 character by 4 line LCD display
- 27 keys, numeric keypad, function keys and XYZ control keys
- Software controlled piezoelectric buzzer

Up to 4 active keypads can be used with MintDrive at any one time.

When connecting a KeypadNode to the CAN2 bus, the node must be added to the network as usual using the `REMOTESETUP` and `NODETYPE` keyword (see sections B.3.6 on page 121 and B.3.7 on page 122).

However, because MintDrive allows up to 4 KeypadNodes to be connected to the bus, the `KEYPADNODE` keyword must also be used to inform Mint of the terminal channel to be used.

The terminal channel for a KeypadNode is assigned using the Mint constant `_tmLCD1`, `_tmLCD2`, `_tmLCD3` or `_tmLCD4`.

For example, assuming the KeypadNode is configured as node 14 (the default value) type the following commands to add the node to the network on channel `_tmLCD1` :

```
BUS=2
NODETYPE.14 = _ntKEYPAD
PAUSE NODELIVE.14
KEYPADNODE._tmLCD1 = 14
```

where:

<code>BUS=2</code>	sets the default CAN Bus for following commands to CAN Bus 2.
<code>NODETYPE.14 = _ntKEYPAD</code>	assigns node 14 to a Keypad peripheral.
<code>PAUSE NODELIVE.14</code>	waits for the node to become live.
<code>KEYPADNODE._tmLCD1 = 14</code>	assigns keypad terminal channel 1 to the node.

The `PAUSE NODELIVE` command is required to force a wait until the node is live before the `KEYPADNODE` keyword is executed. Without this command an error will occur because there is a small delay before the node becomes live. It should now be possible to communicate with the device.

The `VIEW` keyword can be used to check that the KeypadNode has been connected and is recognized. Type:

```
VIEW NODELIVE
```

The KeypadNode should be displayed next to its node number. An L indicates that the node is live, a D indicates dead.

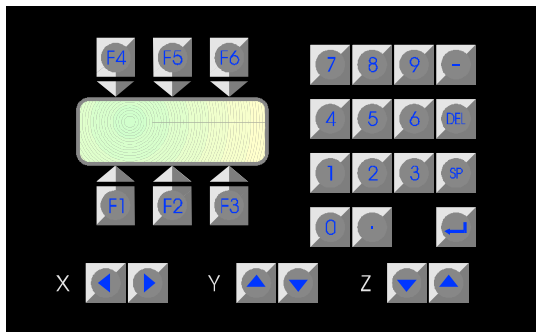

The `TERMINAL` keyword should now be used to turn on the appropriate terminal devices. For example, type:

```
TERMINAL = _tmLCD1 OR _tmRS232
PRINT "Hello"
```

The keyword `TERMINAL` is used to set the terminal input/output channels for the MintDrive. By default the MintDrive is assigned to communicate with only the RS232, RS485 and CAN1 channels, so it must be set to communicate with a KeypadNode.

`Hello` will appear on the RS232 port and the LCD display of KeypadNode.

Any key presses from the KeypadNode or the PC keyboard (on the RS232 port) will now be displayed on the PC screen and the KeypadNode.

The group of four code lines on page 124 can be added to the configuration file or a program. Now the KeypadNode has been configured onto the bus, other Mint terminal keywords such as `PRINT#`, `INKEY`, `LOCATE` and `CLS` can be used. See the *CAN Peripherals Installation Manual* and the *Mint Programming Guide* for more details about the KeypadNode and its associated keywords.

B.3.12 ioNode 24/24

ioNode 24/24 supports 24 input channels and 24 output channels. Inputs are opto-isolated and are organized into three banks of eight, each bank having its own common connection. Outputs are opto-isolated and are organized into three banks of eight. This makes ioNode 24/24 electrically equivalent to 3 *InputNode8* plus 3 *OutputNode8*. The pin numbering of connectors and the functions of the jumpers and CAN LEDs have been made as similar as possible in all products.

For full details see the *CAN Peripherals Guide*.

The node can be configured using the methods described in the previous sections, using a `NODETYPE` of `_ntIONODE24_24`.

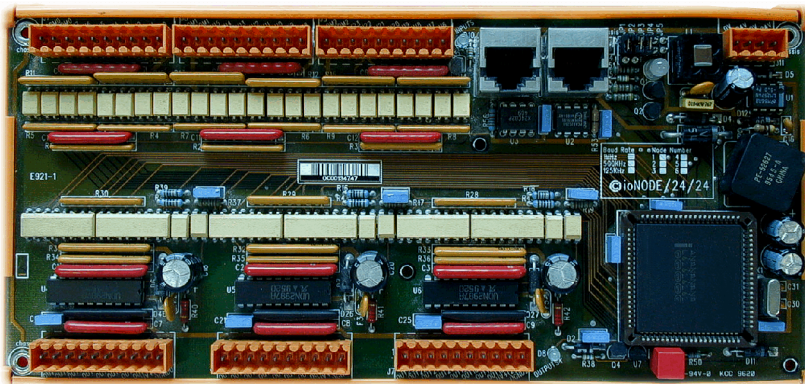

Figure B.1 ioNode 24/24

B.3.13 Example CAN network

To show the steps required in putting a CAN network together, a multi node network is described below. The network will include:

- 1 MintDrive controller
- 2 InputNode 8 nodes
- 2 OutputNode 8 nodes
- 1 RelayNode 8 node
- 1 ioNode 24/24 node
- 1 KeypadNode node

The nodes are daisy-chained together with the MintDrive and KeypadNode node at the ends of the network. The controller is housed a short distance from the machine, with the CAN peripherals distributed around the machine near to their respective actuators and sensors. Each node is supplied with 24VDC from a bus supplying the machine. The CAN Baud rate will be the default 125 Kbaud.

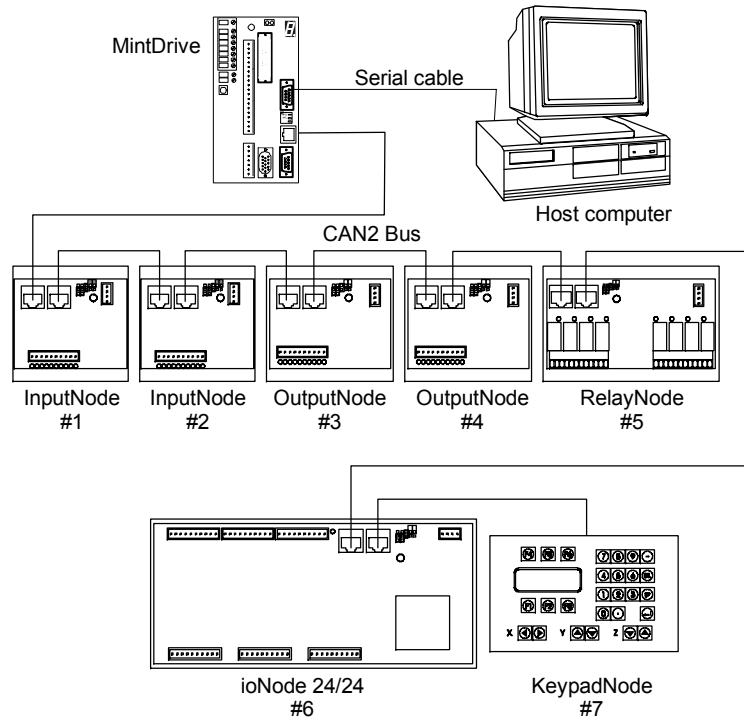

For the following steps, you might wish to refer to section B.3.6 on page 121:

- Statically configure the two InputNode 8 nodes with Node IDs 1 and 2.
- Statically configure the two OutputNode 8 nodes with Node IDs 3 and 4.
- Statically configure the RelayNode 8 node with Node ID 5.
- Statically configure the ioNode 24/24 node with Node ID 6.
- Statically configure the KeypadNode node with Node ID 7.
- Terminate the network. On the MintDrive, the terminator should be selected by setting the CAN2 DIP switch into the ON position. On the KeypadNode, the terminator should be selected by fitting jumper JP3. The remaining nodes should have their terminators disconnected by removing jumper JP3.
- Power up the system.
- Once Mint is running, scan the network for nodes by typing:

```
NODESCAN.0
```

- Now type:

```
VIEW NODELIVE.2
```

to display all the active nodes on the CAN2 network.

B.3.14 Mint CAN related keywords

The following Mint keywords are used for communicating with CAN. Full details of the use and syntax of Mint commands can be found in the *Mint Programming Guide*.

Keyword	Abbreviation	Keyword	Abbreviation
CANBAUD	CB	REMOTEBOUNCE	RD
CANBUSRESET	CBR	REMOTEESTOP	RES
CANEVENT	CV	REMOTEIN	RI
CANEVENTINFO	CVI	REMOTEINPUTACTIVELEVEL	RIA
CLS	CLS	REMOTEINX	RIX
INKEY	IK	REMOTEOUT	RO
KEYPADNODE	KN	REMOTEOUTPUTACTIVELEVEL	ROA
LINE	LINE	REMOTEOUTPUTERROR	ROE
LOCATE	LOCATE	REMOTEOUTX	ROX
NODELIVE	NL	REMOTERESET	RR
NODETYPE	NT	REMOTESSETUP	RMS
PRINT	?	REMOTESTATUS	RS
READKEY	RK	TERMINAL	TM

B.3.14.1 Using abbreviations

Abbreviations can make text entry at the Terminal window much faster.

For example, the baud rate of the CAN2 bus can be set/read using the keyword CANBAUD (or CB).

To print (on screen) the current baud rate you could type:

```
PRINT CANBAUD.2
```

You could also type:

```
?CB.2
```

which would have exactly the same effect.

Note: If the BUS keyword has been used to set the default CAN Bus to 2, there is no need to type the .2 extension. The baud rate is stored on the MintDrive and will be recalled each time the unit is powered up.

C.1 Outline

This section provides general information regarding recommended methods of installation for CE compliance. It is not intended as an exhaustive guide to good practice and wiring techniques. It is assumed that the installer of the MintDrive is sufficiently qualified to perform the task, and is aware of local regulations and requirements.

Baldor products which meet the EMC directive requirements are indicated with a “CE” mark. A duly signed CE declaration of conformity is available from Baldor.



C.1.1 Declaration of Conformity

Baldor indicates that the products are only components and not ready for immediate or instant use within the meaning of “Safety law of appliance”, “EMC Law” or “Machine directive”. The final mode of operation is defined only after installation into the user’s equipment. It is the responsibility of the user to verify compliance. The product conforms with the following standards:



DIN VDE 0160 / 05.88:
Electronic equipment for use in electrical power installations

DIN VDE 0100:
Erection of power installations with nominal voltages up to 1000V

DIN IEC 326 Teil 1 / 10.90:
Design and use of printed boards

DIN VDE 0110Teil 1-2 / 01.89,
DIN VDE 0110Teil 20 / 08.90:
Dimensioning of clearance and creepage distances

EN 60529 / 10.91
Degrees of protection provided by enclosures

		
Baldor Optimised Control Limited 136 Old London Road Little Gaddes Luton, Bedfordshire UK, LU11 9PT 3100		
Date: 29/8/99 EC Declaration of Conformity Ref: 0800007-000		
This is to certify that MintDrive (a combined single-axis Motor Controller & Servo Drive) being one of:- MD26S1A00-TR(y) MD26S2A00-TR(y) MD26S3A00-TR(y) MD26S2A07-TR(y)		
(where x = Blank or R, and y = Blank or 3)		
built after the 1 st June 1999, when used in accordance with the guidance given in the MintDrive Installation Guide (08013288-SP01),		
conforms with the protection requirements of Council Directive 89/368/EEC relating to Electromagnetic Compatibility, by the application of the following standards:		
Standard	Title	Comments
EN61800-3: 1996	Adjustable speed electrical power drive systems Part 3: EMC Product standard including specific test methods	Essences and intensity comply with the requirements for both the first (domestic) and second (industrial) environments
and conforms with the protection requirements of Council Directive 73/23/EEC relating to Low Voltage Equipment, by following the guidance therein in the following standard:-		
Standard	Title	Comments
EN50176: 1997	Electronic equipment for use in power installations	Supply shall not exceed installation over-voltage category III, protective earthing is required
Signed:  Robert Pearce (Development Manager)		

C.1.2 EMC Conformity and CE marking

The information contained herein is for your guidance only and does not guarantee that the installation will meet the requirements of the council directive 89/336/EEC.

The purpose of the EEC directives is to state a minimum technical requirement common to all the member states within the European Union. In turn, these minimum technical requirements are intended to enhance the levels of safety both directly and indirectly.

Council directive 89/336/EEC relating to Electro Magnetic Compliance (EMC) indicates that it is the responsibility of the system integrator to ensure that the entire system complies with all relative directives at the time of installing into service.

Motors and controls are used as components of a system, per the EMC directive. Hence all components, installation of the components, interconnection between components, and shielding and grounding of the system as a whole determines EMC compliance.

The CE mark does not inform the purchaser which directive the product complies with. It rests upon the manufacturer or his authorized representative to ensure the item in question complies fully with all the relative directives in force at the time of installing into service, in the same way as the system integrator previously mentioned. Remember, it is the instructions of installation and use, coupled with the product, that comply with the directive.

C.1.3 Use of CE compliant components

The following points should be considered:

- **Using CE approved components will not guarantee a CE compliant system!**
- The components used in the drive, installation methods used, materials selected for interconnection of components are important.
- The installation methods, interconnection materials, shielding, filtering and grounding of the system as a whole will determine CE compliance.
- The responsibility of CE mark compliance rests entirely with the party who offers the end system for sale (such as an OEM or system integrator).

C.1.4 EMC wiring technique

Cabinet

Using a typical electroplated zinc coated enclosure, connected to ground, means that all parts mounted on the back plane are connected to ground and all shield (screen) connections can be connected to ground. Within the cabinet there should be a spatial separation between power wiring (motor and AC power cables) and control wiring.

Screen connections

All connections between components must use shielded cables. The cable shields must be connected to the enclosure. Use conductive clamps to ensure good ground connection. With this technique, a good ground shield can be achieved.

EMC filters

The EMI or mains filter should be mounted next to the power supply. For the connection to and from the mains filter screened cables should be used. The cable screens should be connected to screen clamps on both sides. An exception to this is the analog command signal.

Grounding (Earth)

For safety reasons (VDE0160), all Baldor components must be connected to ground with a separate wire. Ground connections must be made from the central ground to the regen resistor enclosure and from the central ground to the Shared Power Supply.

C.1.5 EMC installation suggestions

To ensure electromagnetic compatibility (EMC), the following installation points should be considered to help reduce interference:

- Grounding of all system elements to a central ground point
- Shielding of all cables and signal wires
- Filtering of power lines.

A proper enclosure should have the following characteristics:

- All metal conducting parts of the enclosure must be electrically connected to the back plane. These connections should be made with a grounding strap from each element to a central grounding point.*
- Keep the power wiring (motor and power cable) and control wiring separated. If these wires must cross, be sure they cross at 90 degrees to minimize noise due to induction.
- The shield connections of the signal and power cables should be connected to the screen rails or clamps. The screen rails or clamps should be conductive clamps fastened to the cabinet.**
- The cable to the regeneration resistor must be shielded. The shield must be connected to ground at both ends.
- The location of the AC mains filter has to be situated close to the drive so the AC power wires are as short as possible.
- Wires inside the enclosure should be placed as close as possible to conducting metal, cabinet walls and plates. It is advised to terminate unused wires to chassis ground.*
- To reduce ground current, use the largest suitable wire available for ground connections.

* Grounding in general describes all metal parts which can be connected to a protective conductor, e.g. housing of cabinet, motor housing, etc. to a central ground point. This central ground point is then connected to the main plant (or building) ground.

** Or run as twisted pair at minimum.

C.1.6 Wiring of shielded (screened) cables

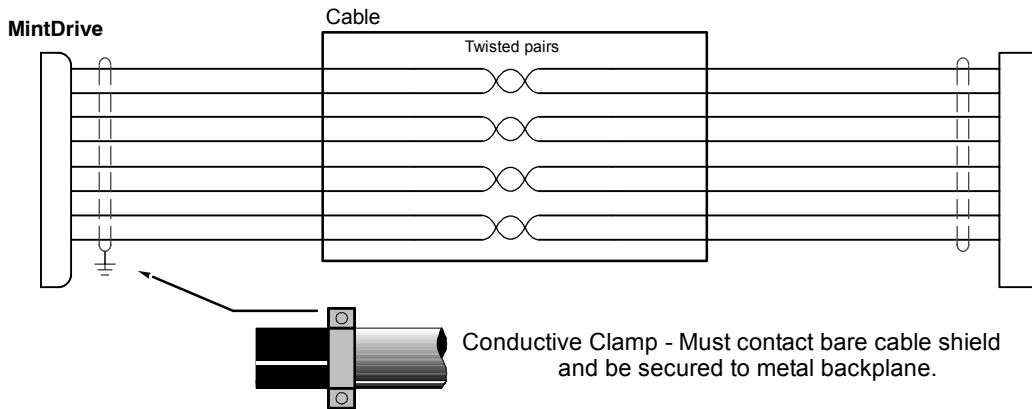
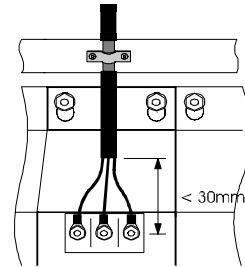
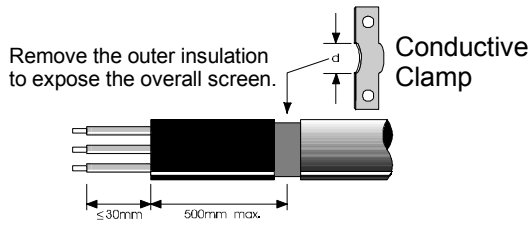

Figure C.2 Grounding cable screens

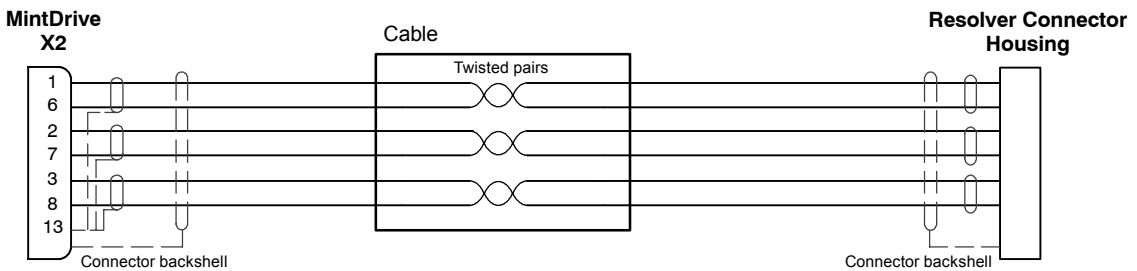

Figure C.3 Resolver cable grounding

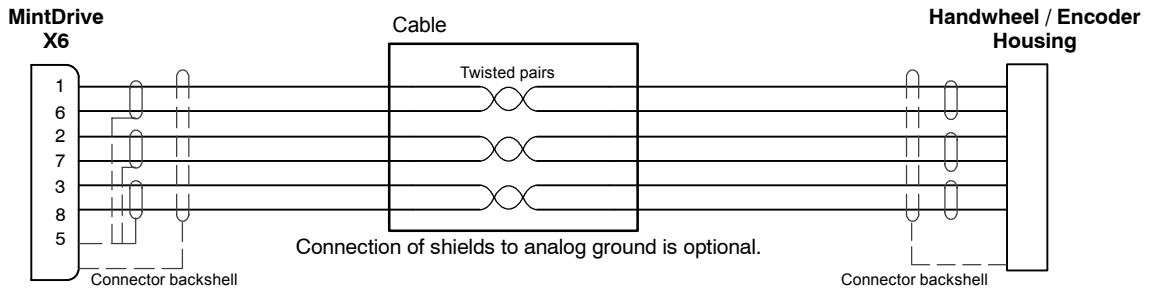

Figure C.4 Handwheel (Encoder) cable grounding

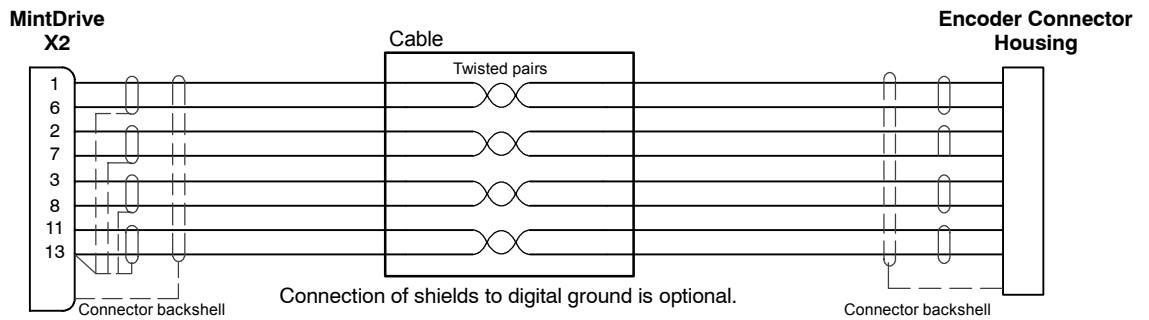

Figure C.5 Encoder signal cable grounding

D.1 Outline

This section describes common accessories and options that you may need to use with your MintDrive.

D.1.1 Cables

Shielded (screened) cables provide EMI / RFI shielding and are required for compliance with CE regulations. All connectors and other components used must be compatible with this shielded cable.

Cable rated current	Cable assembly description	Baldor catalog number	Length	
			ft	m
20 Amps	Power Cable Assembly Threaded connector (Standard Metric Style)	CBL015SP-FHM	5	1.5
		CBL030SP-FHM	10	3.0
		CBL046SP-FHM	15	4.6
		CBL061SP-FHM	20	6.1
		CBL076SP-FHM	25	7.6
		CBL091SP-FHM	30	9.1
		CBL106SP-FHM	35	10.6
		CBL122SP-FHM	40	12.2
		CBL152SP-FHM	50	15.2
		CBL229SP-FHM	75	22.9
	CBL305SP-FHM	100	30.5	
	Power Cable Assembly Quick Connect Style	CBL030SP-FHQ	10	3.0
		CBL061SP-FHQ	20	6.1
		CBL076SP-FHQ	25	7.6
		CBL091SP-FHQ	30	9.1
		CBL106SP-FHQ	35	10.6
		CBL152SP-FHQ	50	15.2
	Power Cable Assembly CE Style Threaded Connector	CBL030SP-FHCE	10	3.0
		CBL061SP-FHCE	20	6.1
		CBL091SP-FHCE	30	9.1
CBL152SP-FHCE		50	15.2	
Power Cable No Connectors	CBL030SP-F	10	3.0	
	CBL046SP-F	15	4.6	
	CBL061SP-F	20	6.1	
	CBL076SP-F	25	7.6	
	CBL091SP-F	30	9.1	
	CBL152SP-F	50	15.2	
30 Amps	Power Cable No Connectors	CBL030SP-E	10	3.0
		CBL046SP-E	15	4.6
		CBL061SP-E	20	6.1
		CBL091SP-E	30	9.1
		CBL152SP-E	50	15.2

D.1.2 Resolver feedback cable

The following table lists the part numbers of resolver feedback cables for use with the MintDrive.

Motor type	Cable assembly description	Baldor catalog number	Length	
			ft	m
BSM 50/63/80/90/100	Resolver Feedback Cable Assembly Threaded connector (Standard Metric Style)	CBL015SF-ALM	5	1.5
		CBL030SF-ALM	10	3.0
		CBL046SF-ALM	15	4.6
		CBL061SF-ALM	20	6.1
		CBL076SF-ALM	25	7.6
		CBL091SF-ALM	30	9.1
		CBL106SF-ALM	35	10.6
		CBL122SF-ALM	40	12.2
		CBL152SF-ALM	50	15.2
		CBL229SF-ALM	75	22.9
	CBL305SF-ALM	100	30.5	
	CBL379SF-ALM	125	37.9	
	Resolver Feedback Cable Assembly Quick Connect Style	CBL030SF-ALQ	10	3.0
		CBL061SF-ALQ	20	6.1
		CBL076SF-ALQ	25	7.6
		CBL091SF-ALQ	30	9.1
		CBL106SF-ALQ	35	10.6
	CBL152SF-ALQ	50	15.2	
	Resolver Feedback Cable Assembly CE Style Threaded Connector	CBL030SF-ALCE	10	3.0
		CBL061SF-ALCE	20	6.1
CBL091SF-ALCE		30	9.1	
CBL152SF-ALCE		50	15.2	
BSM 50/63/80/90/100	Resolver Feedback Cable No Connector	CBL030SF-A	10	3.0
		CBL046SF-A	15	4.6
		CBL061SF-A	20	6.1
		CBL091SF-A	30	9.1
		CBL122SF-A	40	12.2
		CBL152SF-A	50	15.2
		CBL213SF-A	70	21.3
		CBL244SF-A	80	24.4
		CBL305SF-A	100	30.5
		CBL457SF-A	150	45.7

D.1.3 EMC mains filters

AC filters remove high frequency noise from the mains supply, protecting the MintDrive. These filters also prevent high frequency signals from being transmitted back onto the power lines and help meet CE requirements. To select the correct filter, see section 2.3.10.

D.1.3.1 Catalog numbers

Schaffner filter type	Rated volts	Rated amps @ 40°C	Leakage current (mA)	Weight lbs (kg)	Baldor catalog number
FN 2070-6-06	250	6	0.4	0.99 (0.45)	ASR30545
FN 2070-10-06	250	10	0.4	1.61 (0.73)	FN2070-10-06
FN 2070-12-06	250	12	0.4	1.61 (0.73)	ASR30548
FN 351-36-33	440	36	28.0	6.61 (3.0)	ASR24670
FN 351-50-33	440	50	29.6	6.83 (3.1)	ASR24671

D.1.3.2 Filter dimensions - FN351-36-33 and FN351-50-33

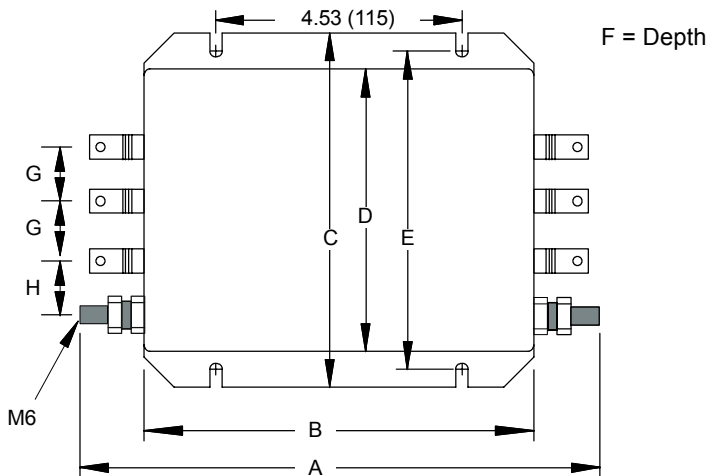

Dimension	Dimensions inches (mm)
A	9.84 (250)
B	7.87 (200)
C	5.9 (150)
D	4.72 (120)
E	5.35 (136)
F	2.55 (65)
G	0.78 (20)
H	0.83 (21)

D.1.3.3 Filter dimensions - types FN2070-6-06, FN2070-10-06, FN2070-12-06

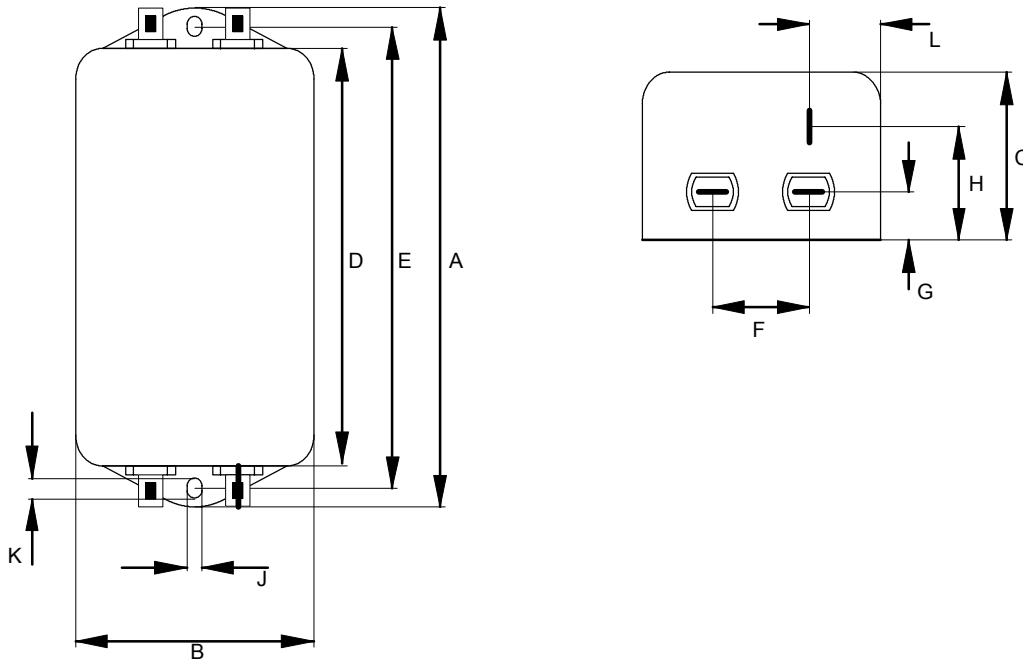

Dimension	Dimensions inches (mm)	
	FN2070-6-06	FN2070-10-06 FN2070-12-06
A	4.47 (113.5)	6.14 (156)
B	2.26 (57.5)	
C	1.83 (46.6)	
D	3.70 (94)	5.14 (130.5)
E	4.06 (103)	5.63 (143)
F	0.98 (25)	
G	0.49 (12.4)	
H	1.28 (32.4)	
J	0.17 (4.4)	0.21 (5.3)
K	0.24 (6)	
L	0.61 (15.5)	

D.1.4 Regeneration resistors

Some drives are shipped with an internal regeneration resistor (see page 2). If an internal resistor is not present, a regeneration resistor should be installed to dissipate energy during braking if a fault “1” (over-voltage) occurs.

MintDrive current rating	Package size	Baldor catalog number			
		115VAC drives		230VAC drives	
		Baldor catalog number	Power rating (W)	Baldor catalog number	Power rating (W)
2.5A	A	RG27	44	RG56	44
5A	B	RG27	44	RG56	44
7.5A	B	RG22	100	RG39	100
10A	C	RG4.7	320	RG10	320
15A	C	RG4.7	320	RG10	320

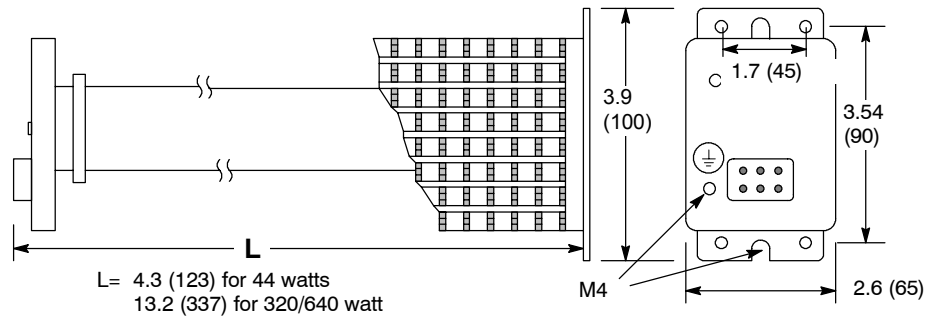

Dimensions: inches (mm)

D.1.5 Breakout board - X5

An optional screw connection fitting is available should you wish to purchase a break-out board. The break-out board, often referred to as a 'card', mounts on a 35mm DIN rail. The board has two-part screw terminals for all of the digital inputs, digital outputs, analog inputs and analog outputs of the MintDrive's X5 connector, together with indicator LEDs.

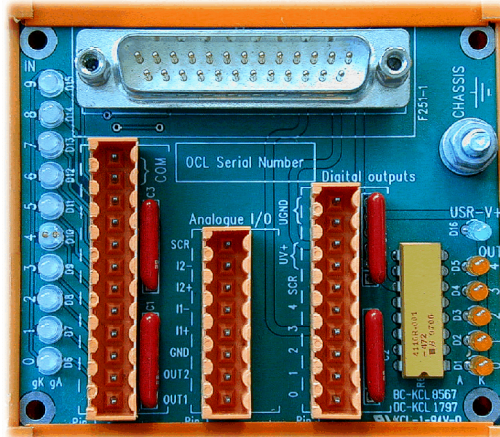

Figure D.1 MintDrive X5 breakout board



BALDOR **MOTORS AND DRIVES**

Baldor UK Ltd
Mint Motion Centre
6 Bristol Distribution Park
Hawkley Drive, Bristol
BS32 0BF, UK

UK TEL: +44 1454 850000 FAX: +44 1454 850001	US TEL: +1 501 646-4711 FAX: +1 501 648-5792	MX TEL: +52 47 61 2030 FAX: +52 47 61 2010
CH TEL: +41 52 647 4700 FAX: +41 52 659 2394	D TEL: +49 89 90 50 80 FAX: +49 89 90 50 8491	F TEL: +33 145 10 7902 FAX: +33 145 09 0864
I TEL: +39 11 562 4440 FAX: +39 11 562 5660	AU TEL: +61 29674 5455 FAX: +61 29674 2495	CC TEL: +65 744 2572 FAX: +65 747 1708

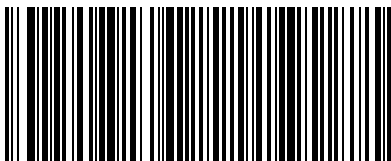

MN1274 06/2001

Printed in UK
© Baldor UK Ltd