

Model:

BF-IDM07

RFID Reader

Operating Guide

BALLUFF

Company Addresses

Europe, Germany, Headquarter

Balluff GmbH

Schurwaldstraße 9

D-73765 Neuhausen, Germany

Argentina

Balluff Argentina S.R.L.

Echeverría 1050, 1st UF 2

1604 Buenos Aires - Florida Oeste

Australia

Balluff Pty Ltd.

18 Malvern Street

Bayswater, 3153 Victoria

Brasil

Balluff Controles Elétricos Ltda.

Rua Francisco Foga, 25 ,Distrito Industrial

CEP 13280.000 – Vinhedo – SP

Canada

Balluff Canada Inc.

2840 Argentinia Road, Unit 2 Mississauga,

Ontario L5N 8G4

China

Balluff (Shanghai) Trading Co. Ltd.

No.800 Chengshan Rd, 8F, Building A, Yunding International Commercial Plaza

200125, Pudong, Shanghai

Japan

Balluff Co., Ltd.

Aqua Hakusan Bldg. 9F 1-13-7 Hakusan, Bunkyo-ku,

Tokyo 113-0001

Mexico

Balluff de México S.A. de C.V.

Anillo Vial II Fray Junipero Serra No. 4416; Colonia La Vista Residencial

CP 76232 Delegación Epigmenio González, Querétaro

USA

Balluff Inc.

8125 Holton Drive, Florence

Kentucky 41042-0937

Model:

BF-IDM07

RFID Reader

Operating Guide

BALLUFF

Regulatory Information

This device complies with part 15 of the FCC Rules and with Industry Canada's licence-exempt RSSs.

Operation is subject to the following two conditions:

- (1) This device may not cause harmful interference, and
- (2) this device must accept any interference received, including interference that may cause undesired operation.

Le présent appareil est conforme aux CNR d'Industrie Canada applicables aux appareils radio exempts de licence. L'exploitation est autorisée aux deux conditions suivantes :

- (1) l'appareil ne doit pas produire de brouillage;
- (2) l'appareil doit accepter tout brouillage radioélectrique subi, même si le brouillage est susceptible d'en compromettre le fonctionnement.

Changes or modifications not expressly approved by the party responsible for compliance voids the user's authority to operate this equipment.

Note: This equipment has been tested and found to comply with the limits for a Class A digital device, pursuant to part 15 of the FCC Rules. These limits are designed to provide reasonable protection against harmful interference when the equipment is operated in a commercial environment. This equipment generates, uses, and can radiate radio frequency energy and, if not installed and used in accordance with the instruction manual, may cause harmful interference to radio communications. Operation of this equipment in a residential area is likely to cause harmful interference in which case the user will be required to correct the interference at his own expense.

Model:

BF-IDM07

RFID Reader

Operating Guide

BALLUFF



Purpose of the Device

The BF-IDM07 RFID Reader is intended to read and write ISO15693 / ISO14443 compliant data carriers via magnetic field communication.

Variability

BF-IDM07 RFID Readers are available in different housings and shapes.

Model:

BF-IDM07

RFID Reader

Operating Guide

BALLUFF

Connecting the Device

BF-IDM07 devices operate in combination with BIS M processor units when connected to one of the ports labeled with "Head 1" or "Head 2". For the connection a shielded standard type 8-wire cable M12 / A-coded is used.

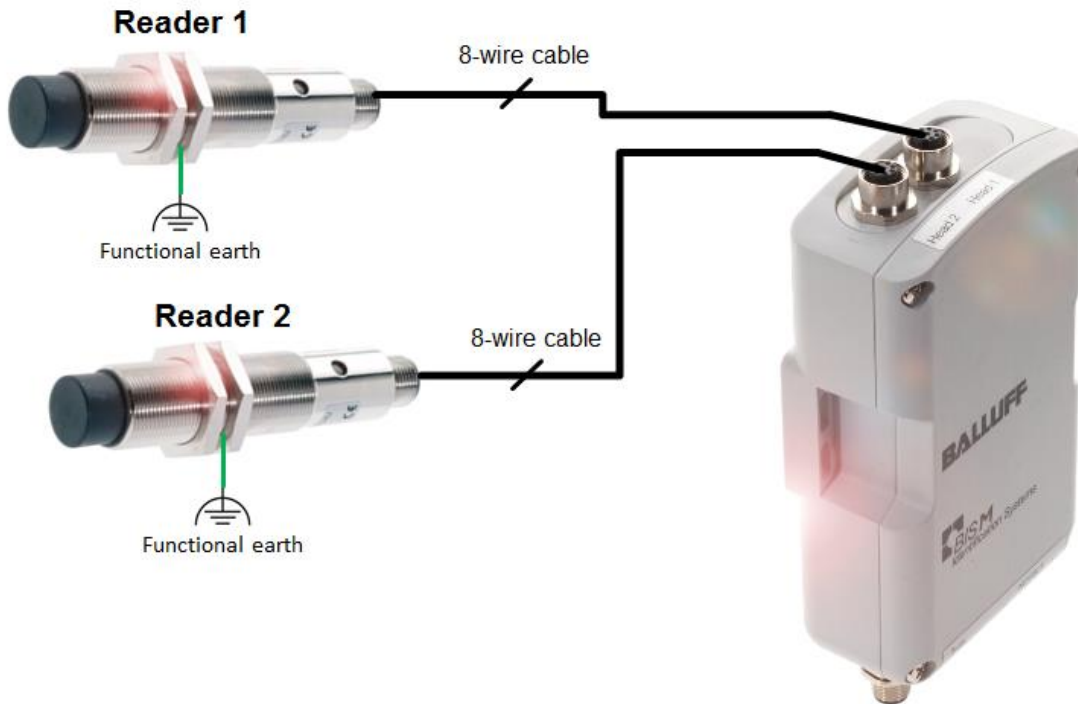

Picture 1: Example Application

To ensure reliable operation in strong EMC environments it is recommended to connect metal housings or dedicated functional ground pins directly to installations ground. The ground connection should be short and stable. Depending on the installation situation an indirect ground connection using a RC combination may be required.

For further notes concerning the installation of the processor unit please refer to the operating guide of the processor unit.

Installation notes

For proper operation at first a suitable mounting position has to be evaluated. The position should respect the recommended clear zones as described. Furthermore, please note that strong electrical or magnetic fields in the close environment may influence the RFID Reader.

Precise information concerning clear zones and distances are available on request.

For BF-IDM07 Readers are available in different housings respectively shapes different types of installation may be considered.

a) Direct In-Hole mounting (Example):

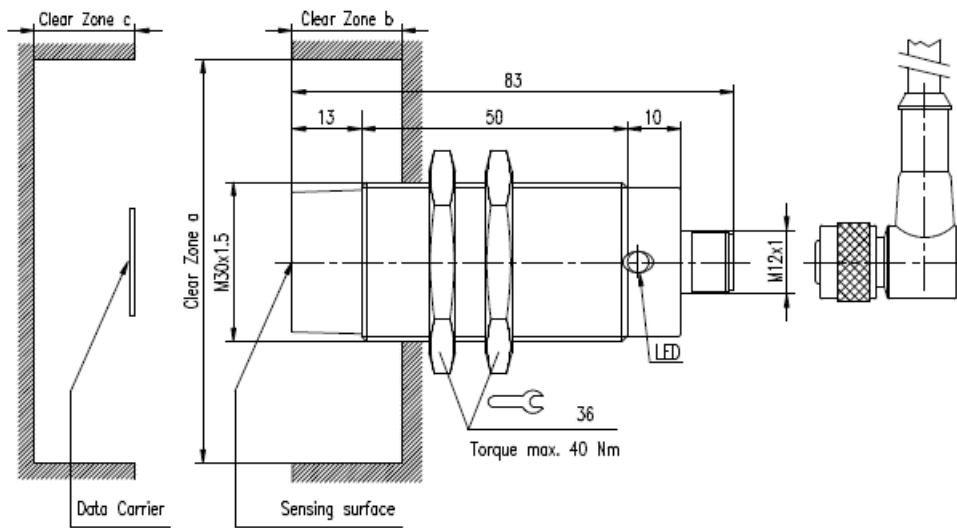

Picture 2: Direct In-Hole mounting (Example)

b) Direct On-Wall mounting (Example):

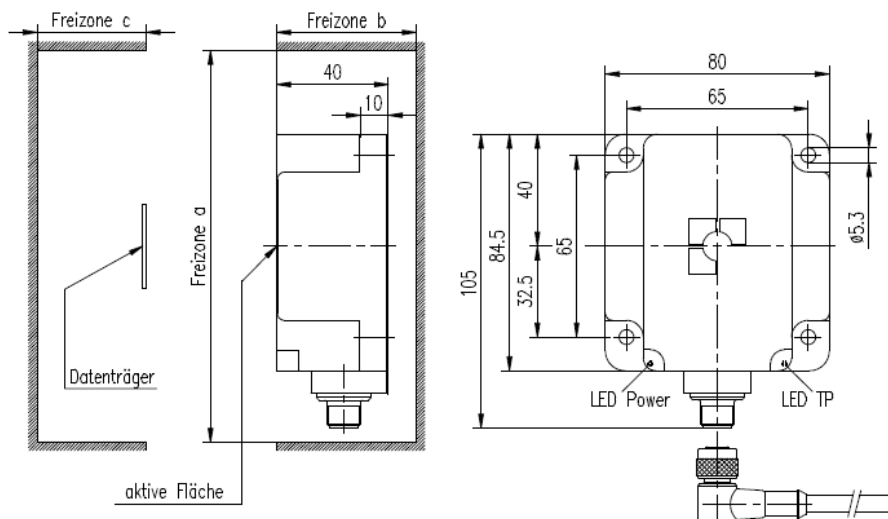

Picture 3: Direct On-Wall mounting (Example)

c) Indirect On-Wall mounting using metal holder (Example):

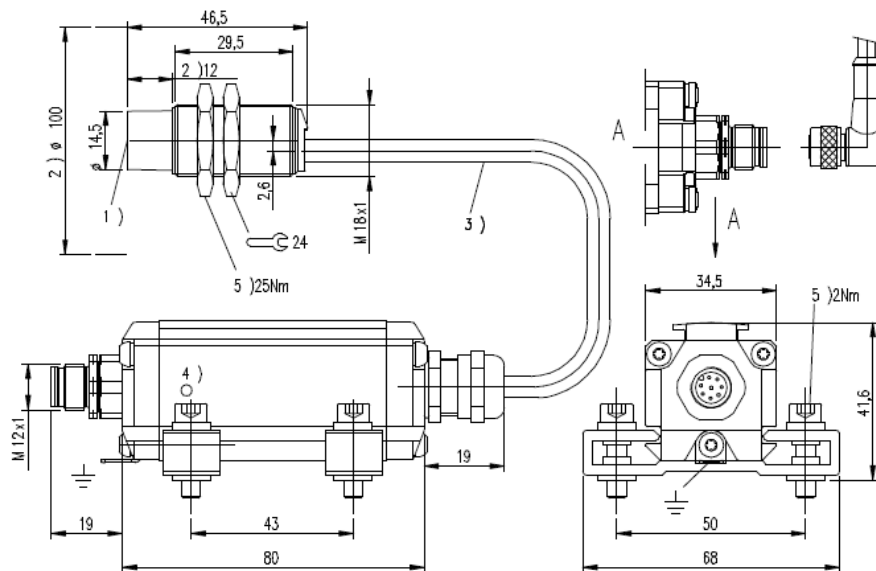

Active surface 2) Clear zone 3) Cable length see notes 4) LED function indicator 5) Tightening torque

Picture 3: Indirect On-Wall mounting using metal holder (Example):

Model:

BF-IDM07

RFID Reader

Operating Guide

BALLUFF

Setup and Operation

For operation of BF-IDM07 Readers a BIS M type processor unit is needed. The processor unit is used as gateway between higher level controllers and RFID Reader. Any communication from and to data carriers respectively RFID Readers is managed by the processor unit. Further information concerning the operation or parameterization of RFID Readers can be found operating guide of the processor unit.

Status Indicators

The device will show its status using the 2 LEDs at the corners of the housing. In normal operation state the meaning of these lights are as follows:

- ▶ Green light "Power" indicates that the device is connected to the processor unit and ready to operate.
- ▶ Orange light "Tag present" indicates that a RFID tag has been detected in front of the transceiver coil.

Electrical Data

Operating voltage (nominal)	+24 V DC
Current draw (at +24 V DC)	≤ 200 mA
Operating Frequency	13.56 MHz
Active principle	Magnetic field
Maximum transmit power	1 W

Mechanical Data

Housing Material	Metal / ABS-GF16 / PBT / PA12-GF30
Weight max.	400g
Ambient temperature	0...+70°C