

---

# User Manual

## **BandLuxe**

### **R558C Series**

### **LTE/HSPA+ Wi-Fi Router**

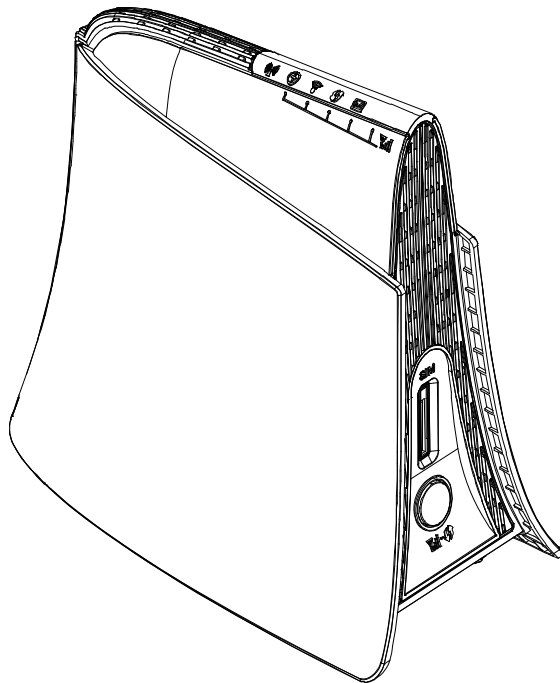



---

# Table of Contents

Features .....	3
Hardware Overview .....	4
Status .....	12
Overview .....	13
System Log .....	14
Traffic Monitor .....	15
Mobile Internet .....	16
System .....	18
System .....	18
General Settings .....	18
Language and Style .....	19
Administration .....	20
Backup / Flash Firmware .....	21
Download backup .....	21
Reset to defaults .....	22
Restore backup .....	22
Reboot.....	23
Services .....	25
Dynamic DNS.....	25
Network.....	26
Interfaces .....	26
Mobile Internet .....	26
Network Settings .....	27
Auto APN Information .....	28
APN Profile Settings .....	28
Reset Modem.....	28
Scenario 1: No mobile internet service .....	29
Scenario 2: Mobile internet service pending.....	29
Scenario 3: Mobile internet service enabled.....	30
Scenario 1: SIM lock absent .....	32
Scenario 2: SIM lock present.....	32
Router .....	34
Router IP .....	34
DHCP Service .....	35
Active DHCP Leases .....	36
Static Leases .....	36
Static Routing.....	37

---

Routing and Redirection Service .....	38
VPN Passthrough .....	38
WiFi .....	39
Advanced Settings .....	42
General Setup .....	43
Wireless Security .....	43
MAC-Filter .....	47
Advanced Settings .....	48
WPS Settings .....	49
Firewall .....	51
Single Port Forward .....	51
Port Range Forward .....	53
Port Trigger .....	55
Security Filter .....	57
Network Filtering .....	60
UPNP .....	62
Advanced .....	63
Diagnostics .....	63
Ping .....	63
Traceroute .....	64
NS Lookup .....	64
SMS .....	64
New SMS .....	65
Inbox .....	67
Outbox .....	68
Draft .....	69
Setting .....	72
Setting .....	72
Backup .....	72
Help .....	74
Logout .....	74
Europe – EU Declaration of Conformity .....	88
Federal Communication Commission Interference Statement .....	90
Glossary .....	92

---

# Package Contents

Thank you for your purchase of this LTE/HSPA+ WiFi Router. This product is designed to access the Internet via 4G technology and share the bandwidth through a Wi-Fi network. It is easy to configure and operate even for non-technical users. This manual contains instructions for installing and configuring the product. Read the manual carefully before you use the product, so that you can fully exploit the product functions.

## Package Contents

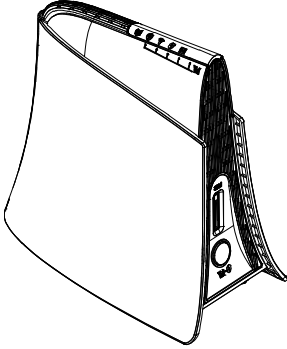
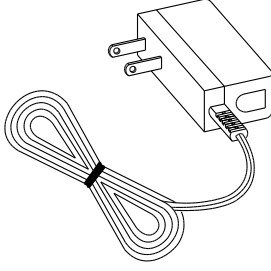
	
<i>R558C series LTE Home Router</i>	<i>Power Adapter</i>

## Features

- R558C series LTE Home Router
- Wi-Fi Protected Setup (WPS) Support
- Uplink up to 50 Mbps
- Downlink up to 100Mbps
- Supports Wi-Fi 802.11 b/g/n
- Supports LAN Ethernet Ports
- Dual embedded cellular antenna (for diversity)

# Hardware Overview

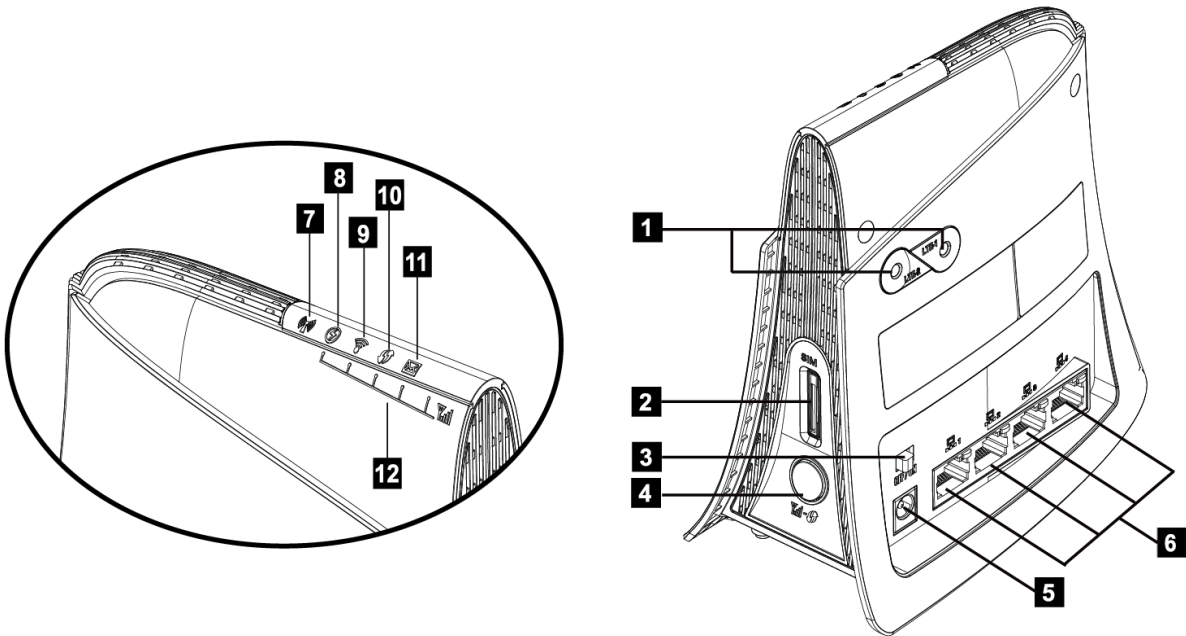

- 1 4G External Antenna Ports**      Connect 4G External Antennas if needed.
- 2 SIM Card Slot**      Insert SIM/USIM. Push-push type.
- 3 Power Switch**      Switch on/off the router.
- 4 Signal Strength LED/WPS/Reset button**      Short press (1 second): Enable signal strength indication.  
Press for 3 seconds (< 10 seconds): Active WPS.  
Long press (>10 seconds): Restore to factory default settings.
- 5 Power Receptor**      Receptor for the Power Adapter.
- 6 LAN Port**      Connect a LAN device as needed.
- 7 Network Status LED**      ● (Blue) 4G LTE  
    ● (Green) 3G HSPA+/HSPA/UMTS/EVDO

---

 (Red) No signal, SIM error, Service failure (no IP) ; Flashing when firmware is being updated

**8 Power LED** Solid when power is on / Signal Strength LED

**9 WiFi LED** Solid when WiFi is on; Flashing during WiFi data transmission / Signal Strength LED

**10 WPS LED** Flashing when WPS is in use /Signal Strength LED

**11 SMS LED** Flashing when there is unread SMS / Signal Strength LED

**12 Signal Strength Bars Reading** Short press on Signal LED/WPS/Reset button, Signal Strength LEDs show current signal strength.

Strong signal: 

Poor signal: 

\*To send and receive SMS may incur additional fees.

Contact your carrier for information about service availability and plans.

---

# Installation

Connect the power Adapter to the Router( **6** ) and connect it to an outlet.

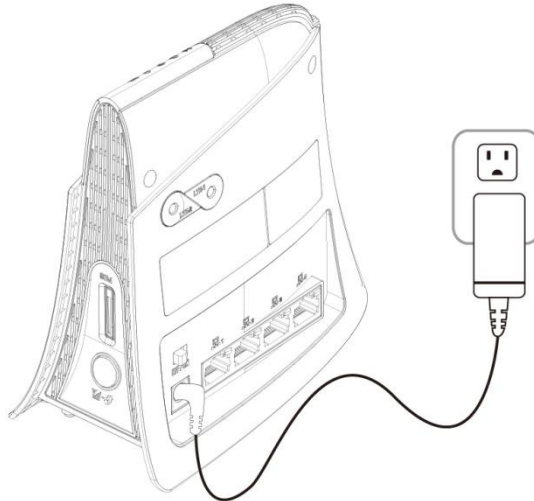

Insert your SIM card into the slot on the Router, making sure the SIM card orientation matches the SIM card slot, as shown in the picture.

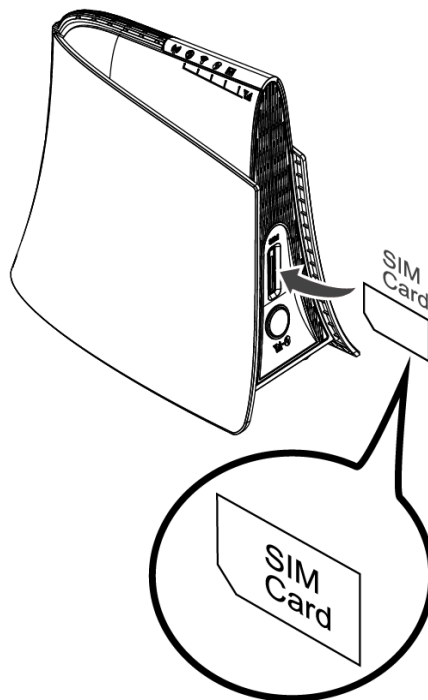



---

Slide the power switch ( **3** ) to ON.

One of the following two methods can be chosen to link your PC with the Router.



---

### Wireless Connection (for Windows)

To connect your PC to the Router via WiFi, in Microsoft Windows, go to Control Panel > Network Connections. Right click on **Wireless Network Connection** and choose **View Available Wireless Networks**. Select default SSID [**BR\_LTE\_xxxx**] and enter default password (WPA key, refer to label on the Router's backside). Click **Connect**. The "xxxx" corresponds with the last 4 digits of MAC address.

### Wireless Connection (for Mac)

To click the  on the upper side of the screen to view available wireless networks.

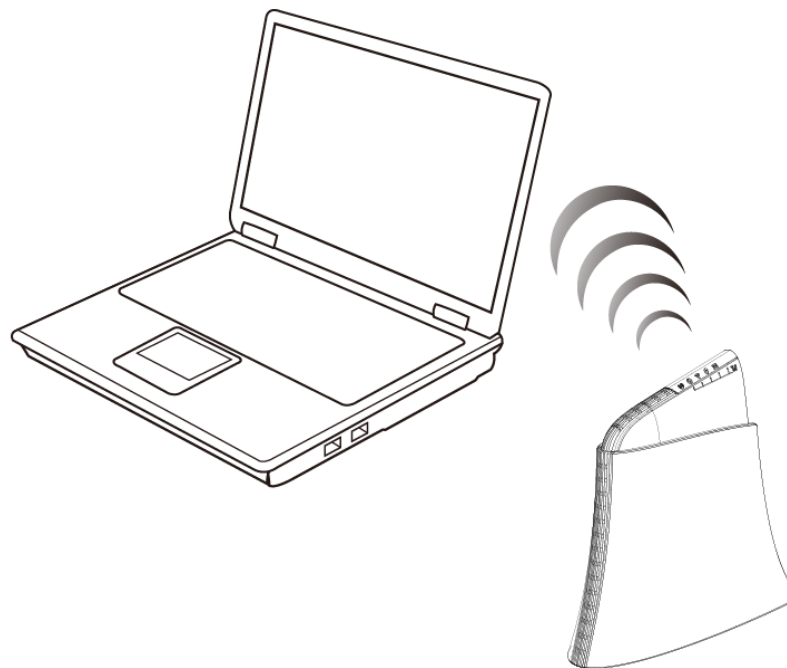

### Wired Connection

To connect your PC to the Router via an Ethernet cable, connect one end of the cable to one of the four LAN ports on the Router, and another end of the cable to an Ethernet port on your computer.

---

The router uses a web-based configuration utility. To access the configuration utility, open a browser (ex: Mozilla, Firefox, etc.) and enter the IP address (**http://192.168.1.1**) for the Router in your browser's address bar.

Enter the router Username (**admin**) and Password (**admin**), and then click

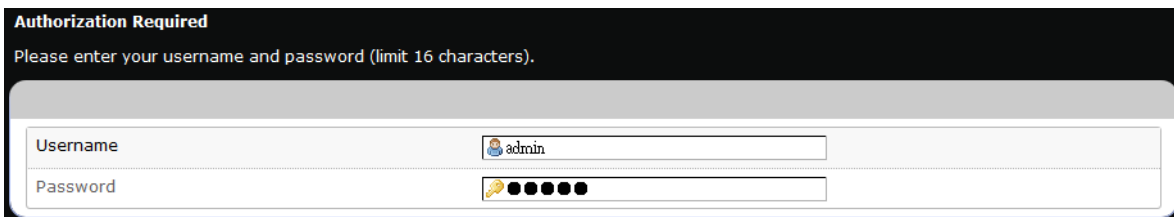
A screenshot of a web-based login form. At the top, a black header contains the text "Authorization Required" in white. Below the header, a grey box contains the instruction "Please enter your username and password (limit 16 characters)." in a small font. The form itself has a white background and a thin border. It contains two input fields: "Username" with the text "admin" and a small user icon to its left; and "Password" with a password icon and six black dots representing the masked password.

# Using Web-based Management

This chapter will guide you on how to configure your router via the web-based utility.

## Login

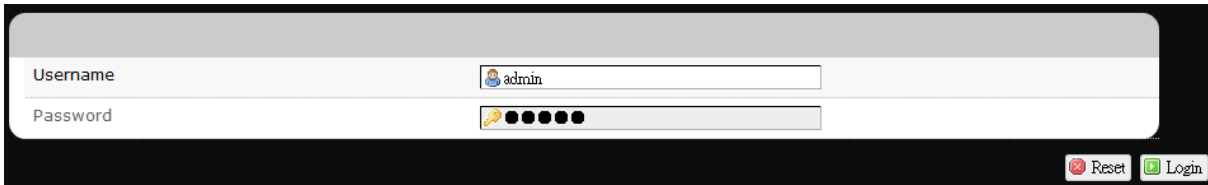

1. Launch a web browser (e.g. Mozilla Firefox).
2. In the address bar, enter <http://192.168.1.1>, then press **Enter**.

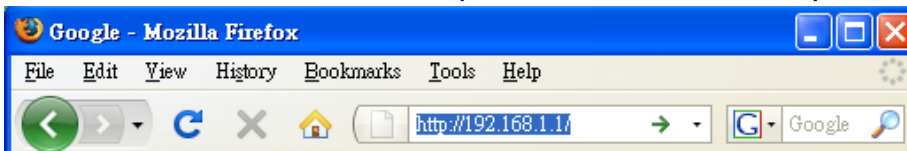

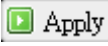
3. On the opening screen, enter the username (**admin**) and password (**admin**).
4. Click **Login**.
5. Click one of the *menu*, *submenu*, and/or *setting* tabs to configure the system. Additionally, the *status area* displays current wireless network information and setting-related messages (e.g. the message **Unapplied Change** appears whenever new settings are temporarily stored in the router without being applied, which will remind you to click the  button).

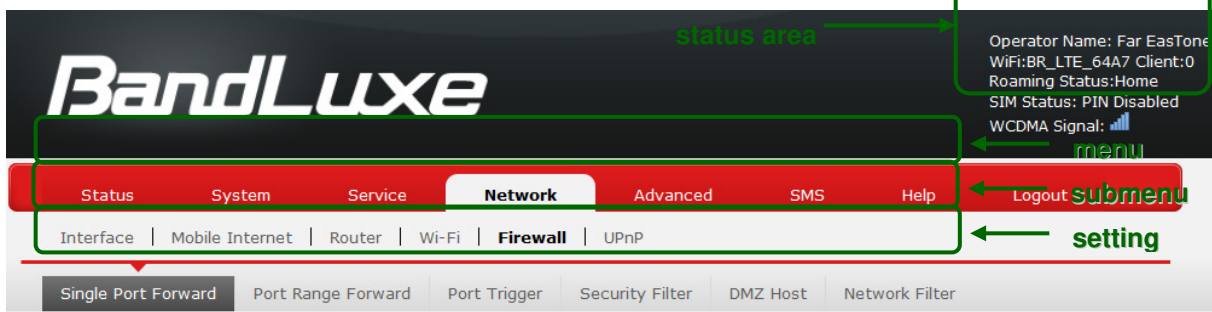

**Note:** If SIM Card's PIN verification is needed, select **Network > Mobile Internet > U/SIM PIN Management**. Enter the PIN code into text box of "PIN Code Verification". Click **Verify**.

---

Mobile internet access will be enabled shortly after.



---

## Status

This menu displays various status of the router. The associated submenu items are: **Overview**, **System Log**, **VnStat Traffic Monitor**, and **Mobile Internet**.

# Overview

**BandLuxe**

Operator Name: Far EasTone  
WiFi:BR\_LTE\_64A7 Client:0  
Roaming Status:Home  
SIM Status: PIN Disabled  
WCDMA Signal:

**Status** | System | Service | Network | Advanced | SMS | Help | Logout

**Overview** | System Log | Traffic Monitor | Mobile Network

### System

Router Model Name	R552
Router Firmware Version	20160831_portRange
Modem Firmware Version	QC_2_00020842_1_001_0001
ICCID:	89886015556480279843
IMEI	359061050004588
Time Zone	UTC
Local Time	Wed Oct 5 06:35:36 2016

### Network

IPv4 WAN Status **Type:** dhcp  
**Address:** 10.170.178.220  
**Netmask:** 255.255.255.248  
**Gateway:** 10.170.178.221  
**DNS 1:** 8.8.8.8  
**DNS 2:** 210.241.208.1  
**Connected:** 3h 13m 11s

IPv6 WAN Status *Not connected*

### DHCP Lease

Hostname	IPv4-Address	MAC-Address	Leasetime Remaining
Eric-PC	192.168.33.155	B4:B5:2F:8F:C5:57	11h 53m 14s

### Local Network

Local MAC Address	Router IP Address	Subnet Mask	DHCP Server	DHCP Server Change	Start IP Address	IP Address Range
00:26:FA:0B:64:A7	192.168.33.1	255.255.255.0	Enable	<a href="#">DHCP Server Change</a>	192.168.33.100	192.168.33.249

### Wireless

Generic 802.11bgn Wireless Controller

**SSID:** [BR\\_LTE\\_64A7](#)  
**Channel:** 9 (2.452 GHz)  
**MAC Address:** 00:26:FA:0B:64:A7  
**Encryption:** WPA-PSK/WPA2-PSK Mixed Mode Force CCMP (AES)

### Associated Stations

MAC-Address	Network
<i>No information available</i>	

The **Overview** submenu renders complete statistics for the router.

---

## System

Displays system information: router model name, router firmware version, modem firmware version, phone number (MDN), ICCID, MIN (MSID), PRL version, IMEI, MEID, and local time.

## Network

Displays current network connection information of IPv4 WAN and/or IPv6 WAN: type of network assignment (e.g. DHCP), network address, netmask, gateway, DNS addresses 1 & 2, and time connected since the establishment of the current mobile internet connection.

## DHCP Leases

Display DHCP lease information for each client: hostname, IPv4 address, MAC address, and lease time remaining.

## Local Network

Displays local network information: local MAC address, router IP address, subnet mask, DHCP server, DHCP server change, start IP address, IP and address range

## System Log

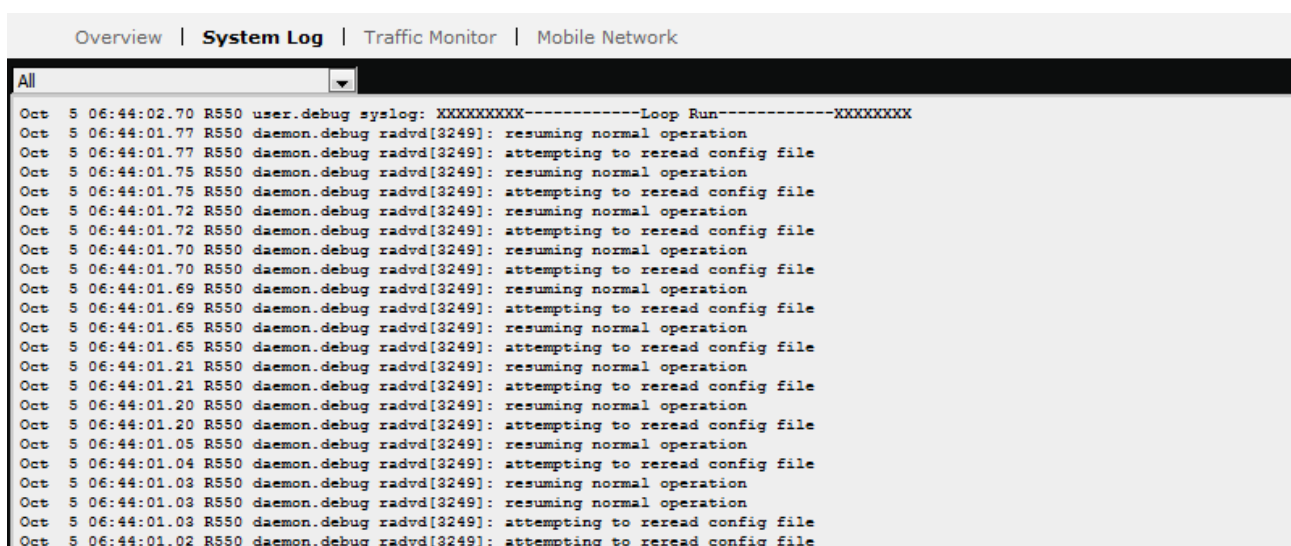

The screenshot shows a navigation bar with 'System Log' selected. Below it is a scrollable log window with a dropdown menu set to 'All'. The log entries are as follows:

```
Oct 5 06:44:02.70 R550 user.debug syslog: XXXXXXXX-----Loop Run-----XXXXXXXX
Oct 5 06:44:01.77 R550 daemon.debug radvd[3249]: resuming normal operation
Oct 5 06:44:01.77 R550 daemon.debug radvd[3249]: attempting to reread config file
Oct 5 06:44:01.75 R550 daemon.debug radvd[3249]: resuming normal operation
Oct 5 06:44:01.75 R550 daemon.debug radvd[3249]: attempting to reread config file
Oct 5 06:44:01.72 R550 daemon.debug radvd[3249]: resuming normal operation
Oct 5 06:44:01.72 R550 daemon.debug radvd[3249]: attempting to reread config file
Oct 5 06:44:01.70 R550 daemon.debug radvd[3249]: resuming normal operation
Oct 5 06:44:01.70 R550 daemon.debug radvd[3249]: attempting to reread config file
Oct 5 06:44:01.69 R550 daemon.debug radvd[3249]: resuming normal operation
Oct 5 06:44:01.69 R550 daemon.debug radvd[3249]: attempting to reread config file
Oct 5 06:44:01.65 R550 daemon.debug radvd[3249]: resuming normal operation
Oct 5 06:44:01.65 R550 daemon.debug radvd[3249]: attempting to reread config file
Oct 5 06:44:01.21 R550 daemon.debug radvd[3249]: resuming normal operation
Oct 5 06:44:01.21 R550 daemon.debug radvd[3249]: attempting to reread config file
Oct 5 06:44:01.20 R550 daemon.debug radvd[3249]: resuming normal operation
Oct 5 06:44:01.20 R550 daemon.debug radvd[3249]: attempting to reread config file
Oct 5 06:44:01.05 R550 daemon.debug radvd[3249]: resuming normal operation
Oct 5 06:44:01.04 R550 daemon.debug radvd[3249]: attempting to reread config file
Oct 5 06:44:01.03 R550 daemon.debug radvd[3249]: resuming normal operation
Oct 5 06:44:01.03 R550 daemon.debug radvd[3249]: resuming normal operation
Oct 5 06:44:01.03 R550 daemon.debug radvd[3249]: attempting to reread config file
Oct 5 06:44:01.02 R550 daemon.debug radvd[3249]: attempting to reread config file
```

The **System Log** submenu tracks system activities after power on.



## Traffic Monitor

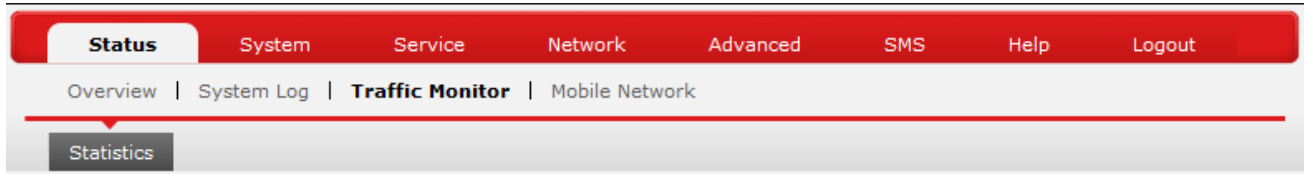

### Statistics

Rest Traffic Flow: Click to discard previous network history log and start a new.

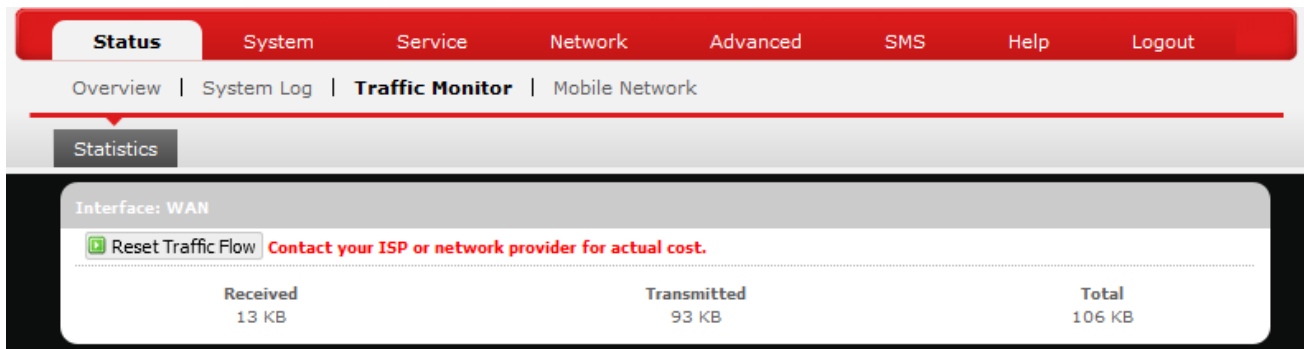

## Mobile Internet

Signal Quality	
Rx Signal Strength (dBm)	-52

UICC/SIM Status	
SIM Status	PIN Disabled(Verified)

Register Network	
Network Name	Far EasTone
Network Technology	WCDMA
Home/Roaming	Home

Internet Connection	
Connection Type	Service Available
Internet IP Address	10.170.178.220
Gateway	10.170.178.221
DNS 1	8.8.8.8
DNS 2	210.241.208.1

The **Mobile Internet** submenu displays mobile internet statistics.

### Signal Quality

Displays signal strength of current mobile internet connection in dBm.

### UICC/SIM Status

Displays current SIM card status:

- a) *Read SIM Fail* – No valid SIM card is inserted
- b) *PIN Disable(Verified)* – PIN protection is disabled while the SIM card status is verified; mobile internet service is available with this status.
- c) *PIN Enable(No Verified/Retries:#)* – PIN protection is enabled while the SIM card verification is pending (whereas # is the number of allowed PIN verifications remaining before SIM lock occurs).
- d) *PIN Enable(Verified)* – PIN protection is enabled while the SIM card status is verified; mobile internet service is available with this status.

---

## Registered Network

a) *Network Name* – name of your mobile internet service provider

b) *Network Technology* – mobile internet communication signal type.

Ex: WCDMA (3G) and LTE (4G).

c) *Home/Roaming* – displays current network roaming status:

Home indicates mobile internet connection to the home location where the SIM card service is registered. Roaming indicates the extended mobile internet connection service in a location different from the home location where the SIM card service is registered. An example of roaming is when you travel abroad.

## Internet Connection

Displays information of current internet connection:

*Connection Type, Internet IP Address, Gateway, and DNS 1/2.*

# System

This menu is for system information and configurations.

## System

The screenshot shows a web interface for system configuration. At the top, there is a red navigation bar with tabs for Status, System (selected), Services, Network, SMS, Help, and Logout. Below this is a breadcrumb trail: System | Administration | Backup / Flash Firmware | Reboot. The main content area is titled 'System Properties' and contains three sections: 'General Settings' (with a sub-tab for 'Language and Style'), 'Time Synchronization', and 'Remote System Log'. In the 'General Settings' section, 'Local Time' is 'Mon Dec 30 03:42:41 2013', 'Hostname' is 'R550', and 'Time Zone' is 'UTC'. In the 'Time Synchronization' section, 'Enable NTP client' is checked, 'NTP server candidates 1' is 'watch.stctime.gov.tw', and 'NTP server candidates 2' is empty. In the 'Remote System Log' section, 'Router LAN client IP Address' is empty and 'Server port' is '514'. At the bottom right, there are buttons for 'Reset', 'Save', and 'Apply'.

## System Properties

Click either the “General Settings” or “Language and Style” tab to configure their respective settings.

### General Settings

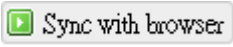
*Local Time* – Displays current local time. To synchronize local time with the browser, click .

*Hostname* – Enter the desired hostname in this check field.

*Time Zone* – Sets the time zone associated with this router. Click on  and select the desired region.

---

## Language and Style

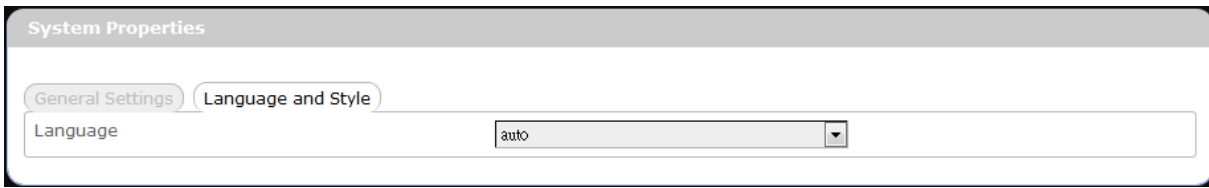

*Language* – Sets the desired display language and style of the router. Click  and select the desired display language and style.

## Time Synchronization

*Enable NTP client:* Click the checkbox to enable/disable. With this option enabled, two more options will appear– “Provide NTP server” and “NTP server candidates”.

*NTP server candidates 1/2:* Enter the desired server candidates here.

## Remote System Log

*Router LAN client IP address:* Displays the client IP address of the router LAN.

*Server port:* Displays port number of the server.

---

## Administration

The screenshot shows a web-based administration interface for a router. At the top, there is a red navigation bar with tabs for Status, System (selected), Services, Network, SMS, Help, and Logout. Below this, a breadcrumb trail reads: System | Administration | Backup / Flash Firmware | Reboot. The main content area is divided into two sections. The first section, titled 'Router Password', contains two input fields: 'Password (limit 16 characters)' and 'Confirmation', each with a password strength indicator icon. The second section, titled 'Remote access', contains a radio button group with 'Enable' and 'Disable' options, where 'Disable' is selected. At the bottom right of the form, there are three buttons: 'Reset' (with a red 'x' icon), 'Save' (with a green checkmark icon), and 'Apply' (with a green play button icon).

### Router Password

Login password of the router can be changed here. Enter the new password in the 'Password' field, and enter the same password once again in the 'Confirmation' field.

### Remote Access

This field specifies whether or not to allow remote access of this router.

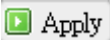
After changing password and/or specifying remote access, click . The screen will display a confirmation message after successful password change.

# Backup / Flash Firmware

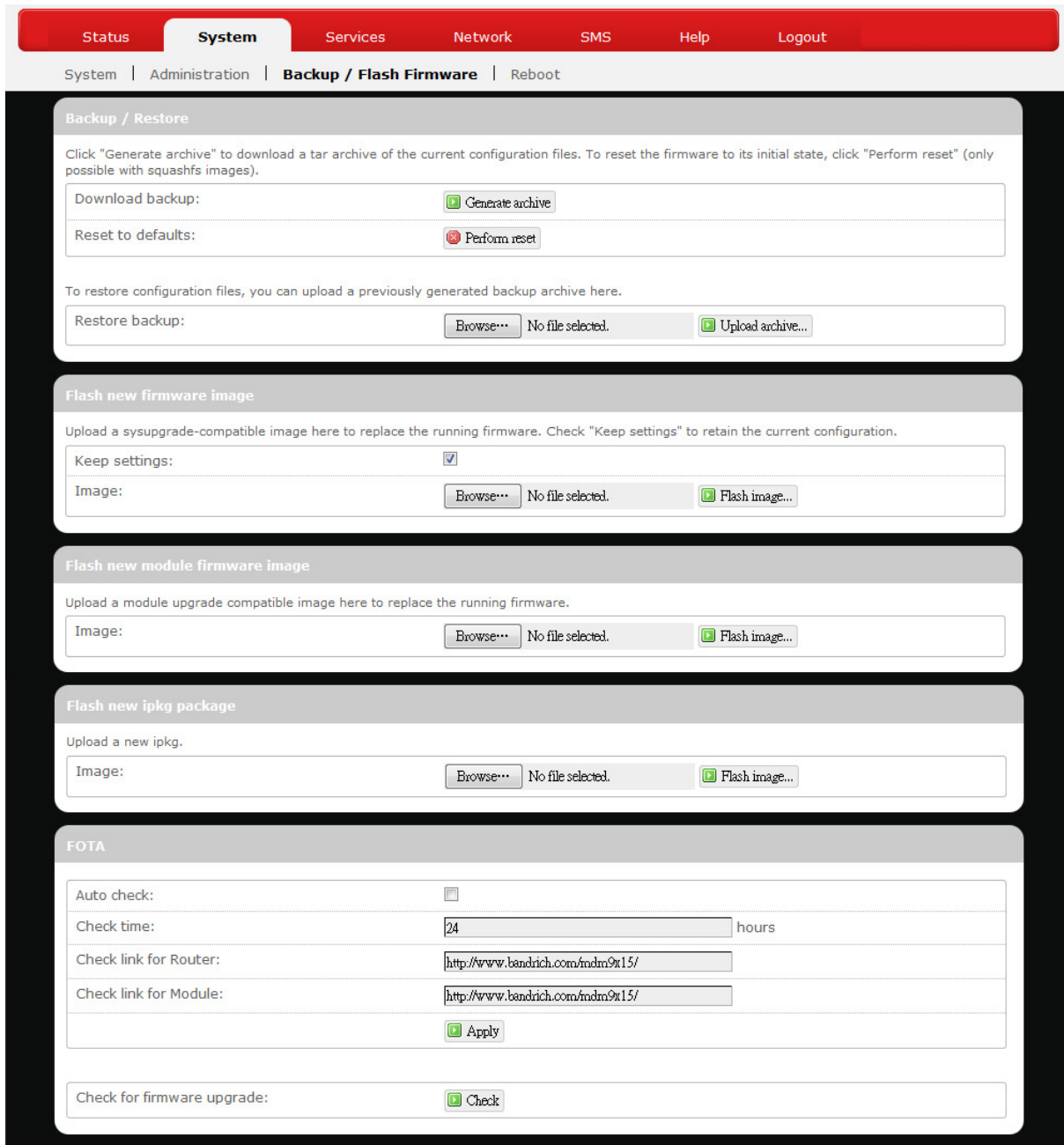

## Backup / Restore

### Download backup

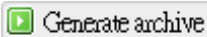
Here you can backup all current settings of the router to a TAR archive file on your computer or mobile device. Just click . A dialog window will prompt you to open or save the archive file. Depending on the browser that you

---

are using, the TAR file may be saved in the system download folder or a location of your choice.

### ***Reset to defaults***

Here you can restore the router to its original factory settings. Just click



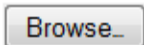
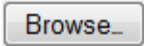
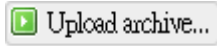

, and a dialog message will appear to indicate the factory reset process. After completion of the reset process, the router will automatically reboot and return to its initial login prompt.

### ***Restore backup***

Here you can restore router settings previously saved as a TAR archive file on your computer or mobile device. Just click  to find and select the previously saved TAR archive file, and then click 'Open'. Confirm that the TAR filename appears beside the  button and click . The system will reboot after completion of backup restoration.

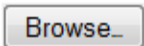
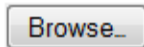
### ***Flash new firmware image***

This option allows you to upgrade this router with the updated firmware image. Just click  to find and select the firmware image file, and then click 'Open'. Confirm that the firmware filename appears beside the  button and click . The system will reboot after successful upgrade.

### ***Flash new module firmware image***

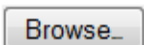
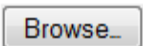
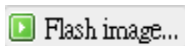
This option allows you to upgrade this router with the updated module firmware image. Just click  to find and select the firmware package file, and then click 'Open'. Confirm that the firmware filename appears beside the  button and click . The system will reboot after successful upgrade.



---

## Flash new ipkg package

This option allows you to upgrade this router with the updated IPKG package.

Just click  to find and select the IPKG package file, and then click

'Open'. Confirm that the IPKG package filename appears beside the

button and click . The system will reboot after successful upgrade.

## FOTA

This option (Firmware Over The Air) allows you to automatically or manually upgrade this router's firmware wirelessly.

For automatic wireless update, enable "*Auto check*" and enter the desired time interval (in hours) between each check of the BandRich website for firmware update. For manual wireless update, disable "*Auto check*". Confirm that the "*Check link for Router*" and "*Check link for Module*" fields have appropriate web address(es) present in their text boxes, i.e.

<http://www.bandrich.com/mdm9x15/> . Click  to activate the wireless update configurations into effect.

To immediately check for firmware upgrade, click **Check**.



**Warning:** Upgrading firmware may take a few minutes; do not turn off the power or press the Reset button during upgrade.

## Reboot

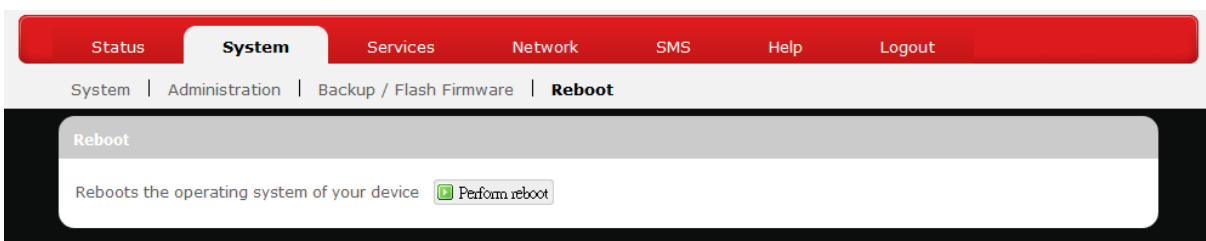

---

Click 'Perform reboot' to restart the router.

# Services

## Dynamic DNS

The screenshot shows a web interface with a red navigation bar at the top containing the following tabs: Status, System, Services (selected), Network, SMS, Help, and Logout. Below the navigation bar, the page title is "Dynamic DNS". The main content area is titled "myddns" and contains a configuration form with the following fields:

Enable	<input type="checkbox"/>
Service	dyndns.org
Hostname	mypersonaldomain.dyndns.org
Username	myusername
Password	••••••••••

At the bottom right of the form, there are three buttons: "Reset", "Save", and "Apply".

The **Services** menu hosts configuration options for DDNS (Dynamic Domain Name Service), which is a system that allows the domain name data held in a name server to be updated in real time. It allows an Internet domain name to be assigned to a computer with a varying (dynamic) IP address. Before you can use this feature, you need to sign up for DDNS with a DDNS provider, [www.dyndns.org](http://www.dyndns.org) or [www.TZO.com](http://www.TZO.com).

**Enable:** Check or un-check this box to enable or disable DDNS.

**Service:** Specifies the DDNS service URL. From the drop-down list, click  and select an URL from the list.

**Hostname:** Enter the hostname for your DDNS account.

**Username:** Enter the username for your DDNS account.

**Password:** Enter the password for your DDNS account.

---

# Network

## Interfaces

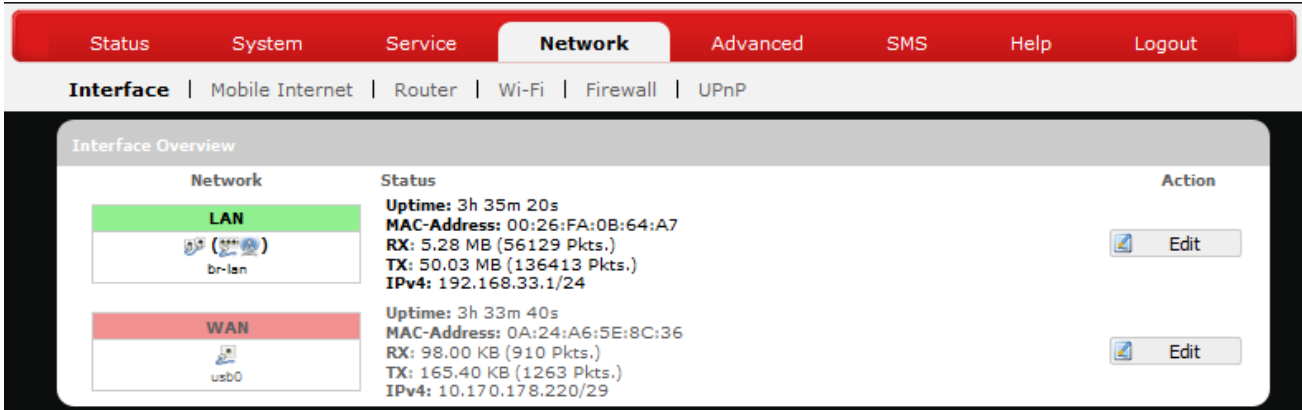

The **Interfaces** submenu allows interface configurations of different networks connected to this router. The configuration items are the same for each network with different default settings.

### Interface Overview

Here you can see the brief network status summary for LAN (local area network) and WAN (wide area network). To configure LAN or WAN interfaces, click the appropriate **Edit** button and follow the below section *Common Configuration* for more details.

## Mobile Internet

The **Mobile Internet** submenu is for setup and adjustment of mobile internet connection and furthermore has four setting tabs: **WWAN Setting**, **U/SIM PIN Management**, **SIM Management**, and **Preferred Network**.

# WWAN Setting

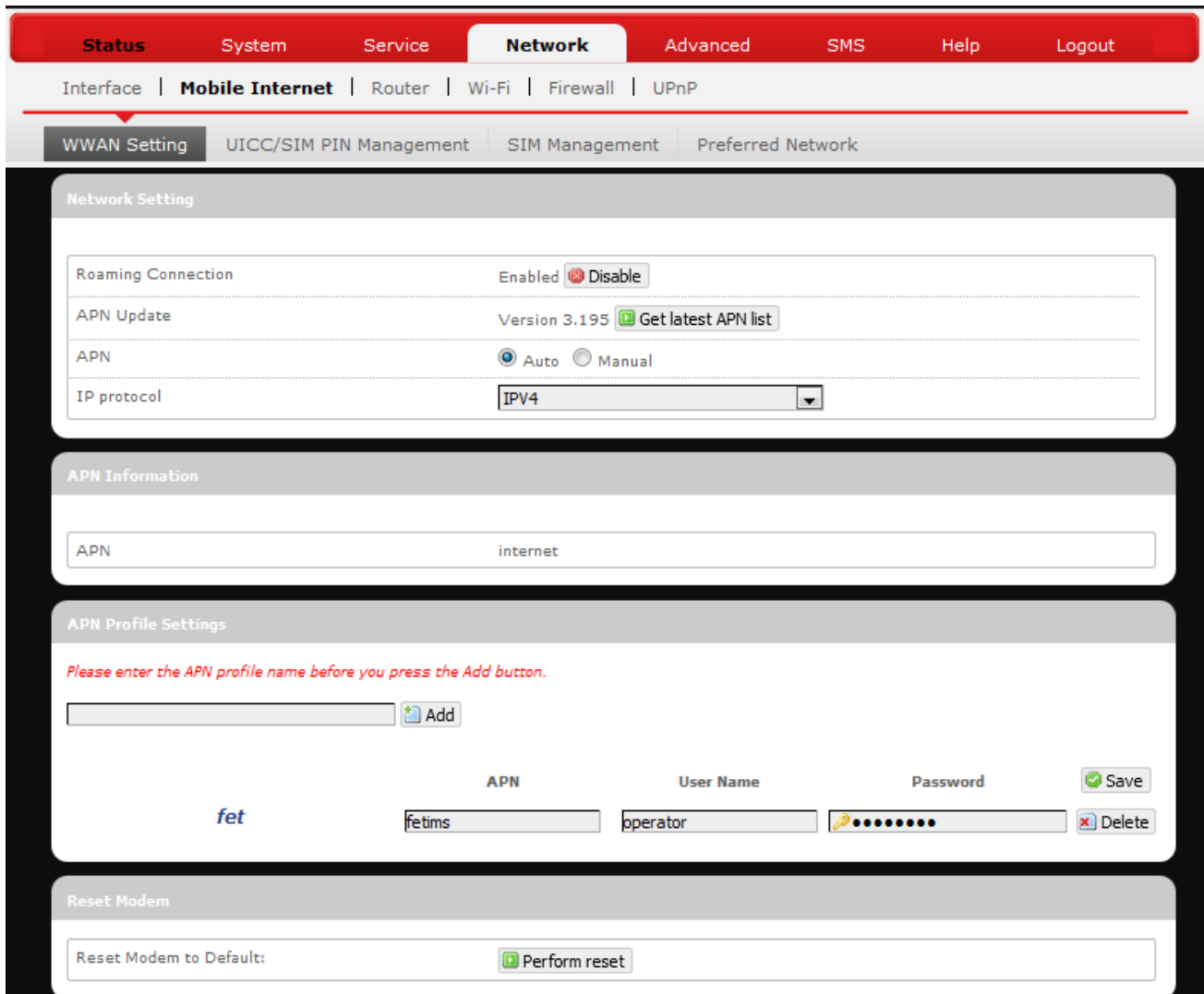

## Network Settings

**Roaming Connection:** Enables or disables current roaming setting.

**APN Update:** Displays the current APN (Access Point Name) version. To get the latest version of APN, click

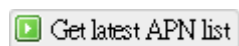

**APN:** ‘Auto’ – Uses automatic APN profile settings for network; this is the default APN setting.  
‘Manual’ – Allows the manual choice of APN Profile

---

Settings for network.

Profile Selection: This item appears when APN is set to 'Manual'.

### ***Auto APN Information***

This section displays automatic APN information.

### ***APN Profile Settings***

#### For Advanced Users

This section allows you to establish your own APN profile settings.

To establish a new APN profile, type in a new APN profile name in the text box and click .

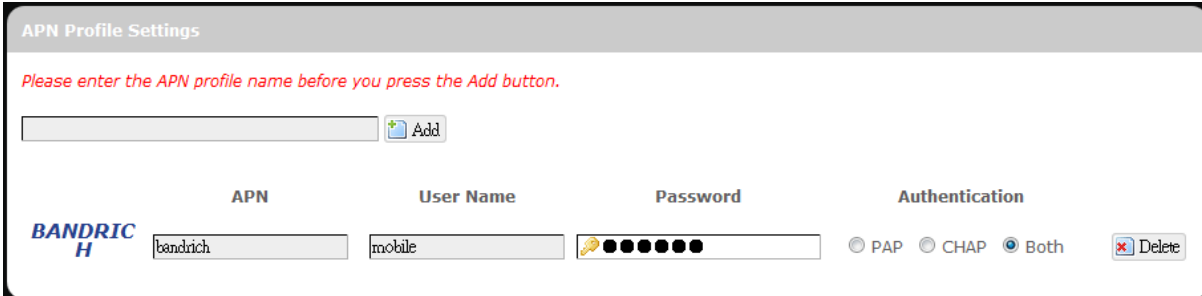

Enter the APN, username, and password. Click .

### ***Reset Modem***

Click **Perform reset** to reset this router to its factory default settings.

## UICC/SIM PIN Management

The screenshot shows a web interface for UICC/SIM PIN Management. At the top, there is a navigation bar with tabs: Status, System, Service, Network (selected), Advanced, SMS, Help, and Logout. Below this is a sub-menu with options: Interface, Mobile Internet (selected), Router, Wi-Fi, Firewall, and UPnP. The main content area has a sub-menu with options: WWAN Setting, UICC/SIM PIN Management (selected), SIM Management, and Preferred Network. The main content is divided into two sections: 'Setting' and 'Change PIN'. The 'Setting' section has three rows: 'SIM Status' with the value 'PIN Enabled (Verified/Retries:3)', 'PIN Protection' with a dropdown menu set to 'Enable', and 'PIN Code' with a masked input field. The 'Change PIN' section has three rows: 'Old PIN Code', 'New PIN Code', and 'New PIN Confirm', each with a masked input field.

This submenu features configurable items that are dependent on the router's mobile internet status, as detailed below.

### ***Scenario 1: No mobile internet service***

Without a valid SIM card inserted into the router, the Verify dialog will show the following SIM card status:

The screenshot shows a 'Verify' dialog box. It has two rows: 'Status:' with the value 'Read SIM Fail' and 'PIN Code verify:' with a masked input field.

Here the Verify dialog shows SIM status as “Read SIM Fail”, meaning that no valid SIM card is inserted.



### ***Scenario 2: Mobile internet service pending***

If a valid SIM card is inserted into the router requiring PIN code verification, the Verify dialog will show the following SIM card status:

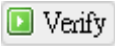
The screenshot shows a 'Verify' dialog box. It has two rows: 'Status:' with the value 'PIN Enable(No Verified/Retries:3)' and 'PIN Code verify:' with a masked input field.

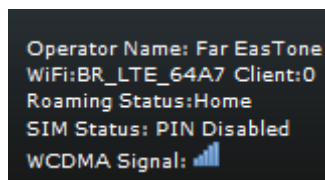
Here the Verify dialog shows the SIM status as “No Verified/Retries:3”, meaning that a valid SIM card is inserted with PIN code verification pending. Enter your SIM card verification code in the text box of “PIN Code verify:”, and then click . Once the PIN code verification is finished, the router is ready to use the SIM card’s associated mobile internet access, and the top right status area will be updated accordingly.

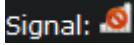

- Operator Name: Displays the name of the internet service provider
- WiFi: Shows the active WiFi SSID of this router
- Counter: Shows number of clients currently connected to the active SSID
- Roaming Status: Displays current roaming status
- SIM Status: Display SIM card status.
- (Carrier) Signal: Displays strength of the indicated signal type (Carrier)  
For example:
  1. Without mobile internet connection, the display will be  (no carrier, no signal).
  2. If WCDMA (3G) mobile internet connection is established, the display will be  (WCDMA carrier, excellent signal strength).

**Scenario 3: Mobile internet service enabled**

If a valid SIM card is inserted into the router with PIN code verified, the configuration dialog will be ‘Setting’ and/or “Change PIN” to allow further SIM card management (click  after making changes):



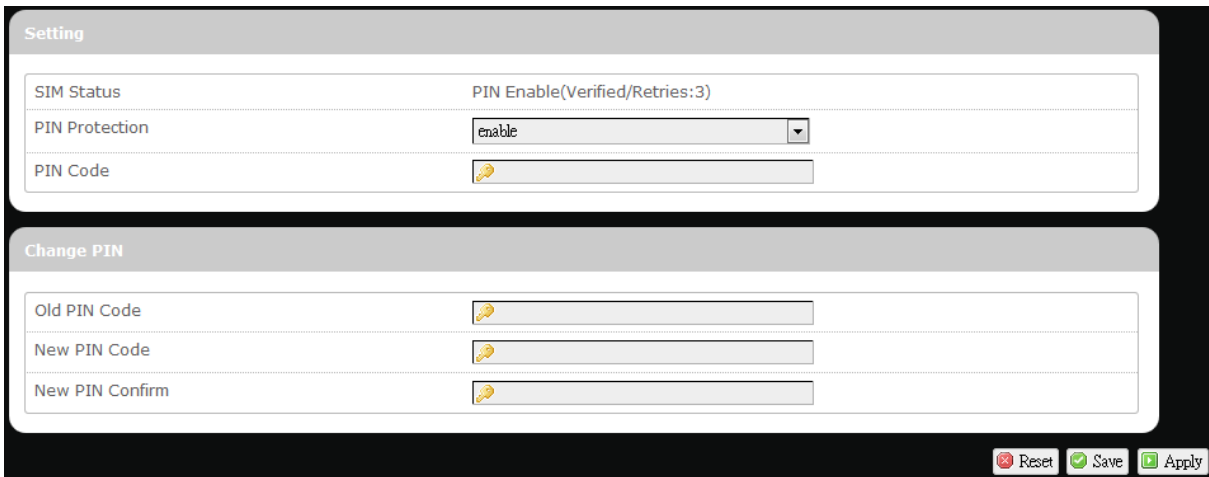

## **Setting**

- SIM Status:** Shows current SIM card status.  
 “*PIN Enable*” means that the SIM card is enabled for mobile internet access.  
 “*PIN Disable(Verified/Retries:#)*” means that the SIM card is enabled for mobile internet access without requiring PIN code verification. Note that if PIN protection is re-enabled, # is the number of allowed PIN verifications remaining before SIM lock occurs.
- PIN Protection:** Enables or disables the PIN protection by clicking  and making the appropriate choice from the drop-down list.
- PIN Code** If PIN protection is enabled, you need to enter PIN code in this text box for making changes in this ‘Setting’ dialog.

## **Change PIN**

This option is configurable only if PIN Protection is enabled.  
 Here you can change the PIN code for enhanced SIM card security.

**Old PIN Code:** Enter the old PIN code.

**New PIN code:** Enter the new PIN code.

New PIN code confirm: Enter the same new PIN code again for PIN code confirmation.

Click  after making changes in 'Setting' and/or "Change PIN".

## SIM Management

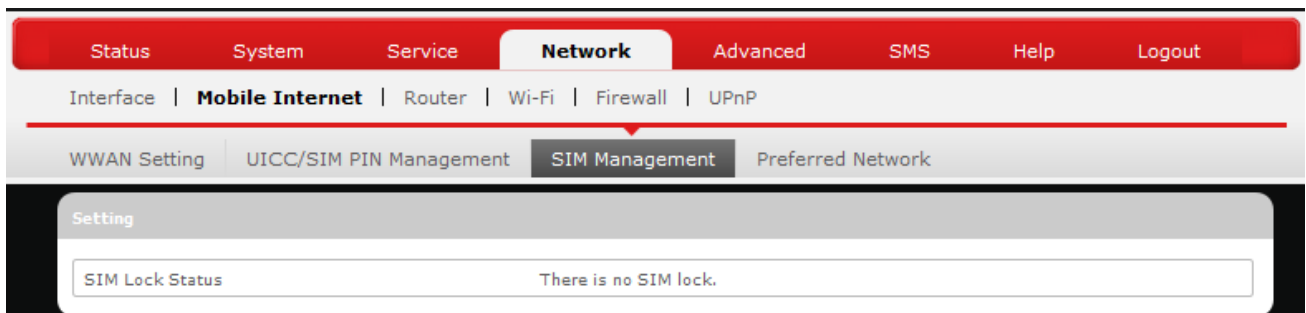

Here you can see the current SIM lock status.

### **Scenario 1: SIM lock absent**

“SIM no lock” means that the SIM card is unlocked.

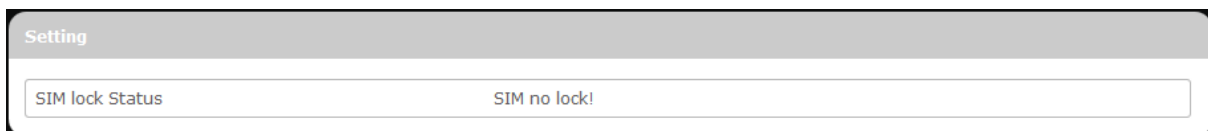

### **Scenario 2: SIM lock present**

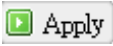
If your SIM card is locked for some reason, here you can also enter the SIM unlock code to unlock it. After entering the SIM unlock code in the text box “SIM Unlock”, click .

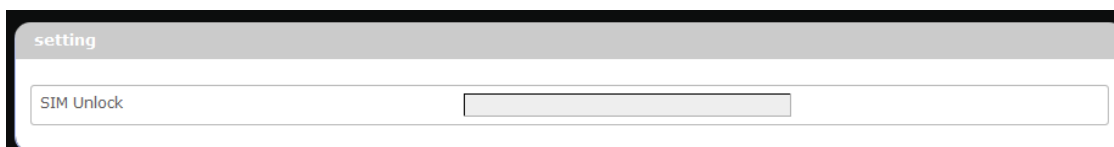

## Preferred Network

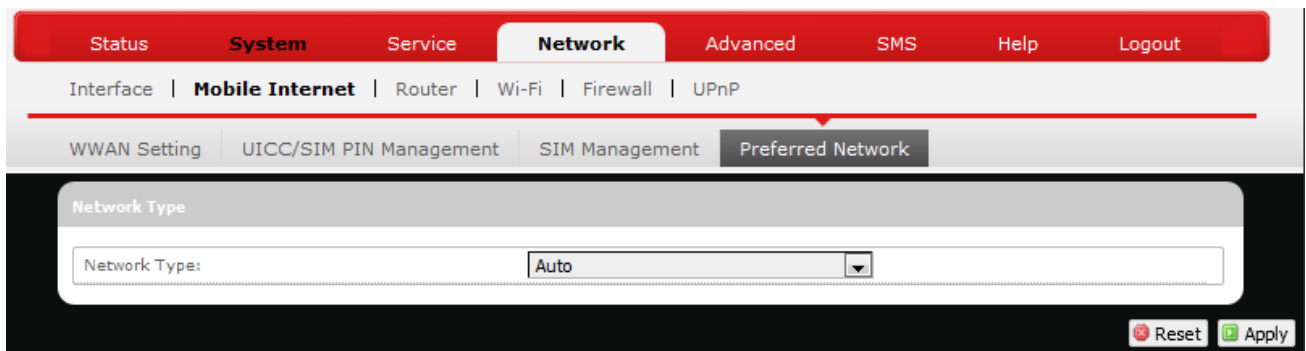

The screenshot shows a web interface for network configuration. At the top, there is a red navigation bar with tabs: Status, System, Service, Network (selected), Advanced, SMS, Help, and Logout. Below this is a breadcrumb trail: Interface | Mobile Internet | Router | Wi-Fi | Firewall | UPnP. A secondary navigation bar contains: WWAN Setting | UICC/SIM PIN Management | SIM Management | Preferred Network (selected). The main content area is titled 'Network Type' and contains a form with a label 'Network Type:' and a drop-down menu currently set to 'Auto'. At the bottom right of the form are 'Reset' and 'Apply' buttons.

Here you can select the preferred mobile network type by clicking  and making a choice from the drop-down list. The default choice is *Auto*. Other available choice examples are *LTE (4G)* and *WCDMA (3G)*.

# Router

## Router Settings

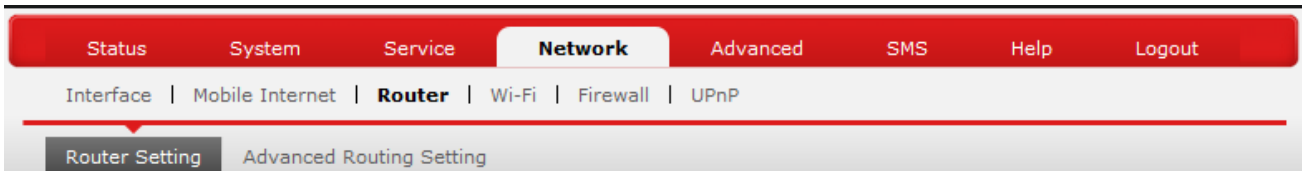

### Router IP

The screenshot shows a form titled 'Router IP' with the following fields:

Local IP Address	192.168.1.1 <small>Local IP Address</small>
Subnet Mask	255.255.255.0 <small>Subnet Mask</small>
Device Name	mylte.br <small>Device Name</small>
MTU	1500 <small>MTU</small>

**Local IP Address:** The default local IP address of this router is 192.168.1.1. If this address conflicts with another local network device, you can enter another local IP address here.

**Subnet Mask:** Displays current Subnet Mask

**Device Name:** The current device name is displayed in gray color. The device name can be changed by typing in the new device name in this text box.

**MTU:** The current MTU (maximum transmission unit with default value of 1500 bytes) is displayed in gray color. The MTU can be changed by typing in the new MTU value in this text box.

## DHCP Service

DHCP Service	
DHCP Server	<input checked="" type="radio"/> Enable <input type="radio"/> Disable
Start IP Address	100 Start IP Address
Maximum Number of Users	150 Maximum Number of Users
Client Lease Time	720 Expiry time of leased addresses, minimum is 2 Minutes (The unit is Minutes).
IP Address Range	192.168.1.100-249 IP Address Range
Primary DNS	 Primary DNS
Secondary DNS	 Secondary DNS

- DHCP Server:** Enables or disables the DHCP Server feature.
- Start IP Address:** Specifies the starting number of the last 3 digits of assigned client IP address. For example, the default value of **100** means that the first assigned client IP address will be 192.168.1.**100**; the next assigned client IP address will be 192.168.1.**101**; and so on...
- Maximum Number of Users:** Specifies maximum number of users for this router. The default setting is 150 users.
- Client Lease Time:** Specifies the amount of lease time allocated to clients of this router, i.e. the expiry time of leased addresses. Use 'h' to indicate hours or use 'm' to indicate minutes.
- IP Address Range:** Displays assignable local IP address range of this router
- Primary DNS:** If needed, specify the primary Domain Name System here.
- Secondary DNS:** If needed, specify the secondary Domain Name System here.

## Active DHCP Leases

Active DHCP Leases			
Hostname	IPv4-Address	MAC-Address	Leasetime remaining
User-NB2	192.168.1.194	20:89:84:85:1A:56	11h 48m 18s





This section displays active DHCP lease information for each client: **Hostname**, **IPv4 address**, **MAC address**, and **Lease time remaining**.

## Static Leases

Static Leases

Static leases are used to assign fixed IP addresses and symbolic hostnames to DHCP clients. They are also required for non-dynamic interface configurations where only hosts with a corresponding lease are served. Use the *Add* Button to add a new lease entry. The *MAC-Address* identifies the host, the *IPv4-Address* specifies the fixed address to use and the *Hostname* is assigned as symbolic name to the requesting host.

Hostname	MAC-Address	IPv4-Address
This section contains no values yet		



This option allows fixed IP address and symbolic hostname assignments for DHCP clients.

To add a static lease, first click .

Static Leases

Static leases are used to assign fixed IP addresses and symbolic hostnames to DHCP clients. They are also required for non-dynamic interface configurations where only hosts with a corresponding lease are served. Use the *Add* Button to add a new lease entry. The *MAC-Address* identifies the host, the *IPv4-Address* specifies the fixed address to use and the *Hostname* is assigned as symbolic name to the requesting host.

Hostname	MAC-Address	IPv4-Address
<input type="text"/>	<input type="text"/>	<input type="text"/>

Enter the desired hostname. Choose the desired MAC address and IPv4-Address (click  and select a rule from the drop-down list; if "--Custom--" is selected, the drop-down list will change to a text box to allow you to enter your custom address).

The MAC address is for host identification, whereas the IPv4 address specifies the fixed address for static lease.

To remove any unwanted static lease, just click the corresponding  button.

Click  after making any changes.

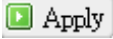
## Advanced Routing settings

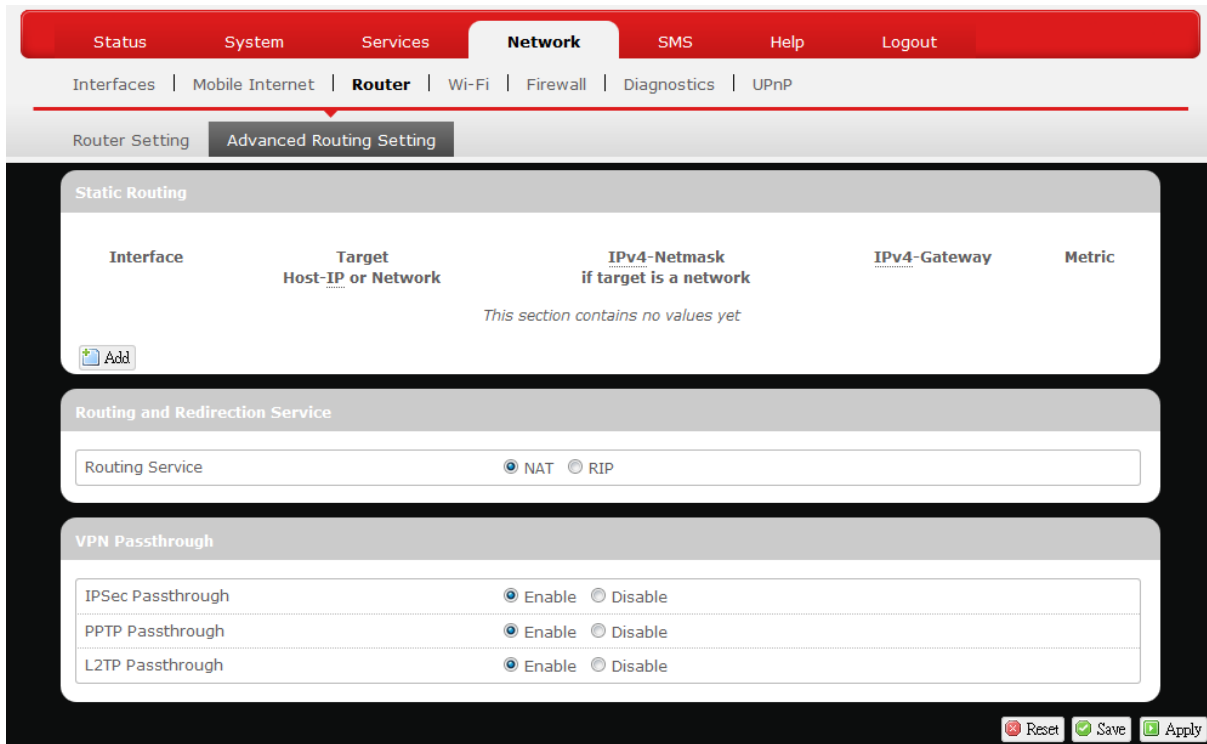

Static Routing

Interface	Target Host-IP or Network	IPv4-Netmask if target is a network	IPv4-Gateway	Metric
<i>This section contains no values yet</i>				



Routing and Redirection Service



Routing Service  NAT  RIP

VPN Passthrough

IPsec Passthrough  Enable  Disable



PPTP Passthrough  Enable  Disable

L2TP Passthrough  Enable  Disable

### Static Routing

This option allows fixed network routing path assignment (as opposed to the initial adaptive routing).

To add a static network routing path, click . To remove any unwanted static network routing path, click the corresponding  button. Click  after making any changes.

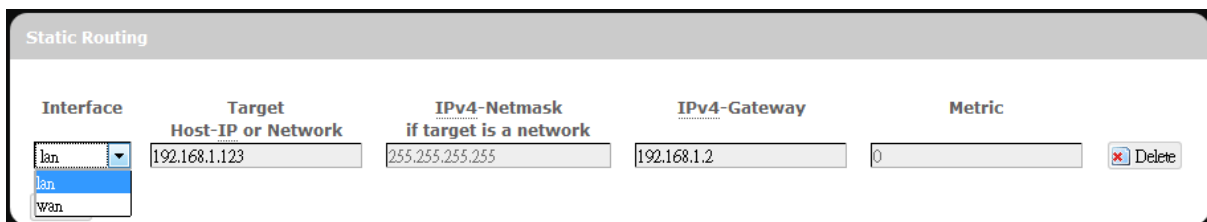

Interface	Target Host-IP or Network	IPv4-Netmask if target is a network	IPv4-Gateway	Metric
lan	192.168.1.123	255.255.255.255	192.168.1.2	0





Interface: Click  and choose 'lan' (local area network) or

---

'wan' (wide area network).

- Target:** Enter the target host IP or network address here.
- IPv4-Netmask:** Displays the IPv4-Netmask address (the default is 255.255.255.255). A custom IPv4-Netmask can also be specified here.
- IPv4-Gateway:** If needed, a custom IPv4-Gateway address can be specified here.
- Metric:** Specifies the network path priority number (usually associated with the network path's administrative distance). The lower the metric number, the higher priority of this static route in the network routing protocol.
- The default value is 0 (highest priority). A different metric number can also be specified here.

**Note:** If contents in the text box is invalid, a  will appear on the right side of the text box, and the text color changes to red. For example, the following demonstrates an invalid target Host-IP or Network address: 

### ***Routing and Redirection Service***

This option enables or disables Network Address Translation (NAT) service, which is a standard that allows multiple computers on a private network to share a single IP address.

### ***VPN Passthrough***

A Virtual Private Network (VPN) is a type of secured private network connection, built upon publicly-accessible infrastructure such as the Internet. They usually provide connectivity to various devices behind a gateway or firewall.



**IPSec Passthrough:** IP Security (IPSec) provides authentication and encryption. Since it is mainly a Layer 3 technology, it can secure all data on the network. To allow IPSec tunnels to pass through the Router, click 'Enabled'.

**PPTP Passthrough:** Point-to-Point Tunneling Protocol (PPTP) allows you to establish a connection to an enterprise network. To allow PPTP tunnels to pass through the Router, click Enabled.

**L2TP Passthrough:** Layer 2 Tunneling Protocol (L2TP) is an extension of the Point-to-Point Tunneling Protocol and is also used to establish virtual private networks. To allow L2TP tunnels to pass through the Router, click Enabled.

## WiFi

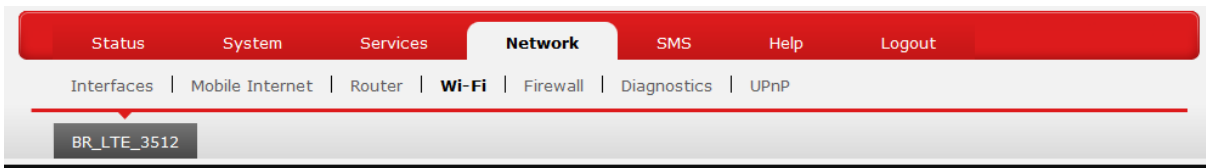

This submenu item is for configuring all Wi-Fi-related settings. This router supports up to two WiFi SSIDs. The default SSID is as follows:

Tab Name	Corresponding SSID	Default Password
"BR_LTE_xxxx"	BR_LTE_xxxx	The last 4 digits of MAC address (xxxx) converted into 2-digit decimal numbers, please see table below for conversion method.

Hexadecimal Digit	Decimal Number	Hexadecimal Digit	Decimal Number
0	00	8	08
1	01	9	09

2	02	A	10
3	03	B	11
4	04	C	12
5	05	D	13
6	06	E	14
7	07	F	15

SSID and Password Example:

MAC Address	Corresponding SSID	Default Password
0026FA0B314A	BR_LTE_314A	03010410

Each tab has identical sets of configuration categories:

**Device Configuration** and **Interface Configuration**.

Please click  after making any changes in this submenu.

## Device Configuration

### General Setup

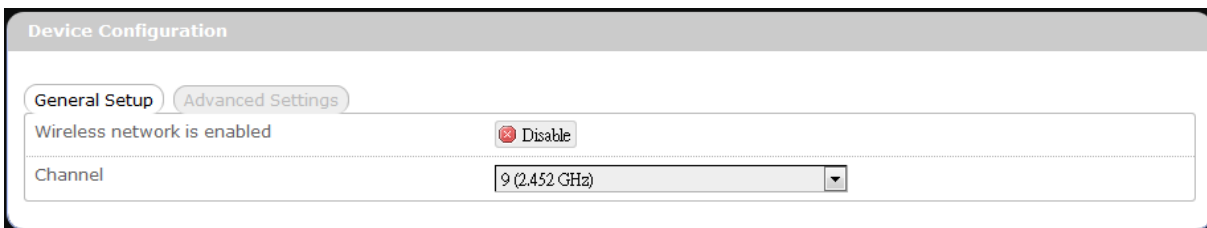

The screenshot shows the 'Device Configuration' window with the 'General Setup' tab selected. The 'Wireless network is enabled' checkbox is checked, and the 'Disable' button is visible. The 'Channel' dropdown menu is set to '9 (2.452 GHz)'.

or

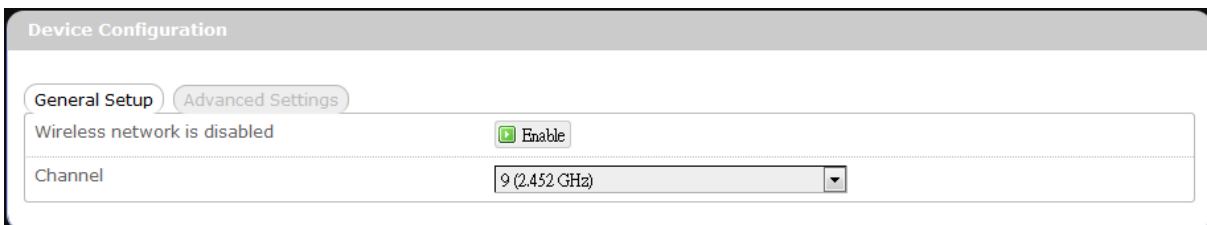

The screenshot shows the 'Device Configuration' window with the 'General Setup' tab selected. The 'Wireless network is disabled' checkbox is checked, and the 'Enable' button is visible. The 'Channel' dropdown menu is set to '9 (2.452 GHz)'.

Wireless network is  WiFi connection of the associated SSID is enabled.

enabled\*

To disable WiFi connection of this SSID, click  .

Wireless network is disabled\*

WiFi connection of the associated SSID is disabled.

To enable WiFi connection of this SSID, click  .

\* Note: The associated SSID is displayed either in the selected submenu tab under WiFi or in the WiFi category item **Interface Configuration → General Setup → SSID**.

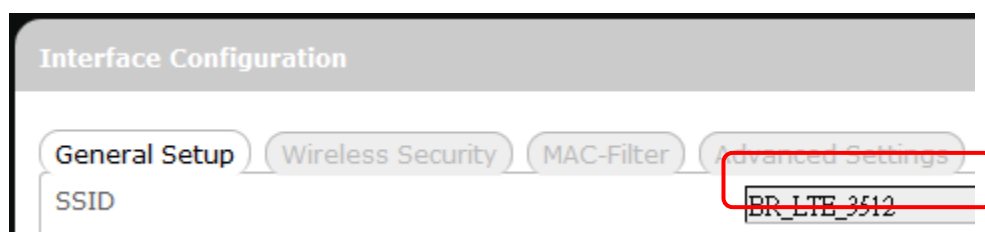

Channel:

Selects the WiFi channel for communication. The available choices are:

Channel (carrier frequency)

1 (2.412 GHz)

2 (2.417 GHz)

3 (2.422 GHz)

4 (2.427 GHz)

5 (2.432 GHz)

6 (2.437 GHz)

7 (2.442 GHz)

8 (2.447 GHz)

9 (2.452 GHz)

10 (2.457 GHz)

11 (2.462 GHz)

auto

← assigns channel automatically

-- custom --



← manually specifies WiFi channel

Normally one of the channels is already selected, and no change is needed unless there exists interference problems with other WiFi or Bluetooth devices (that also use the

2.4GHz frequency range for communications).  
 Alternatively, you can select 'auto' to let the system select the channel automatically, or you can select "-- custom --" and enter your own channel specification in the text box.

## Advanced Settings

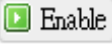
The screenshot shows the 'Advanced Settings' tab in a 'Device Configuration' window. It contains three rows of settings: 'Mode' with a dropdown menu set to 'Auto', 'HT mode' with a dropdown menu set to '20MHz', and 'Dual SSID is disabled' with a checked checkbox and an 'Enable' button.

Mode	Specifies the IEEE wireless standard for WiFi communication. The choices are: Auto: (Default choice) The router automatically chooses the optimal IEEE wireless standard. 802.11b: Data speed up to 11 Mbps 802.11g: Data speed up to 54 Mbps 802.11n: Data speed up to 300 Mbps
HT mode	Specifies channel width for data communications. The choices are: 20MHz: Single 20MHz channel 20MHz / 40MHz: Single or dual 20MHz channels
Dual SSID is disabled/enabled	Click  to activate the second SSID, or click  to deactivate the second SSID.

## Interface Configuration

### General Setup

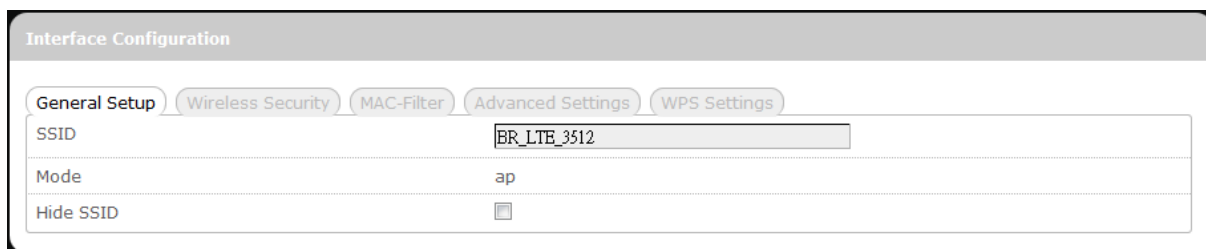

Interface Configuration				
General Setup	Wireless Security	MAC-Filter	Advanced Settings	WPS Settings
SSID	BR_LTE_3512			
Mode	ap			
Hide SSID	<input type="checkbox"/>			

- SSID** Service Set Identification  
To change the SSID, click the text box and enter the new SSID (up to 32 alphanumeric characters)
- Mode** Wireless operating mode of this router.  
AP: Wireless Access Point
- Hide SSID** Enable this option to make wireless network of *this* SSID unavailable to nearby WiFi clients.  
Disable this option to make wireless network of *this* SSID available to nearby WiFi clients (default setting).



**CAUTION:** To enable “Hide SSID”, we strongly advise you to do so via wired LAN connection, since wireless LAN connection with this SSID will be lost with this option applied! If both SSIDs are hidden, then the communications with this router must be done via a LAN port, or this

### Wireless Security

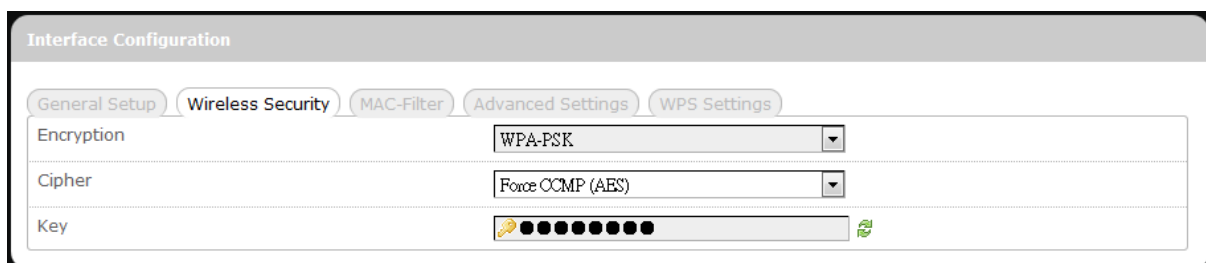

Interface Configuration				
General Setup	Wireless Security	MAC-Filter	Advanced Settings	WPS Settings
Encryption	WPA-PSK			
Cipher	Force CCMP (AES)			
Key	●●●●●●●●			

This router supports wireless data encryption, a must for wireless data security. The Wireless Security Interface Configuration items will change according to the chosen encryption method.

---

The encryption options are:

### 1. No Encryption

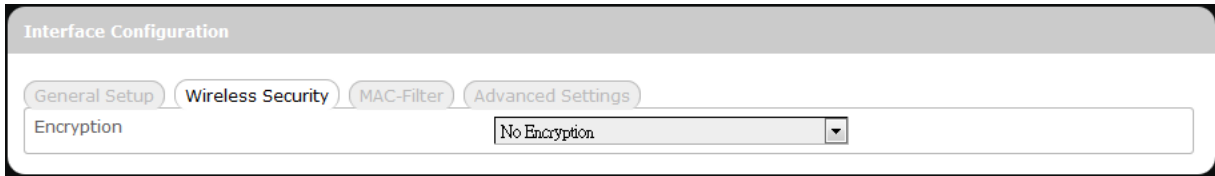

Data transmitted over wireless networks can be seen by others.

### 2. WEP Open System

Wired Equivalent Privacy encryption with Open System authentication

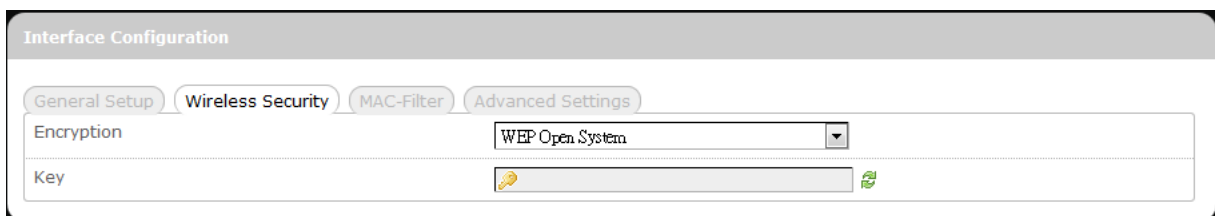

Key: Enter a password for accessing this SSID's wireless network.

### 3. WPA-PSK

"WiFi Protected Access – Pre-Shared Key" encryption

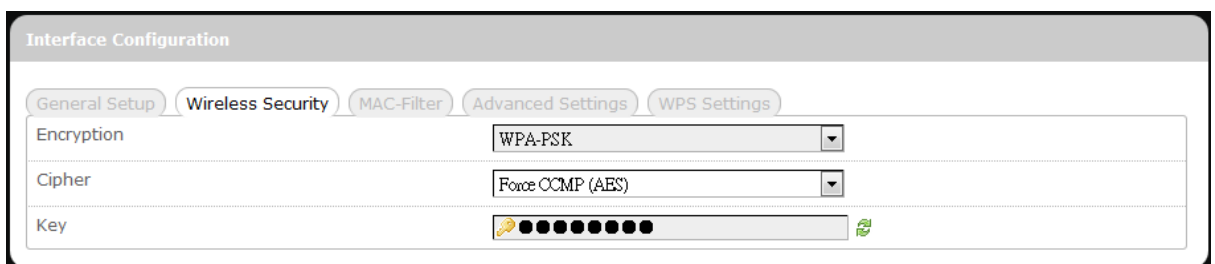

Cipher: Specify the desired encryption protocol by clicking  and selecting an option from the drop-down list:

*auto* – (default setting) the system automatically chooses the optimal encryption protocol

*Force CCMP (AES)* – Use CCMP (AES) encryption exclusively (stronger than TKIP)

*Force TKIP* – Use TKIP encryption exclusively

---

*Force TKIP and CCMP (AES) – Use TKIP and CCMP (AES) encryption protocols together*

Key: Enter a password for accessing this SSID’s wireless network.

#### 4. WPA2-PSK

“WiFi Protected Access II – Pre-Shared Key” encryption

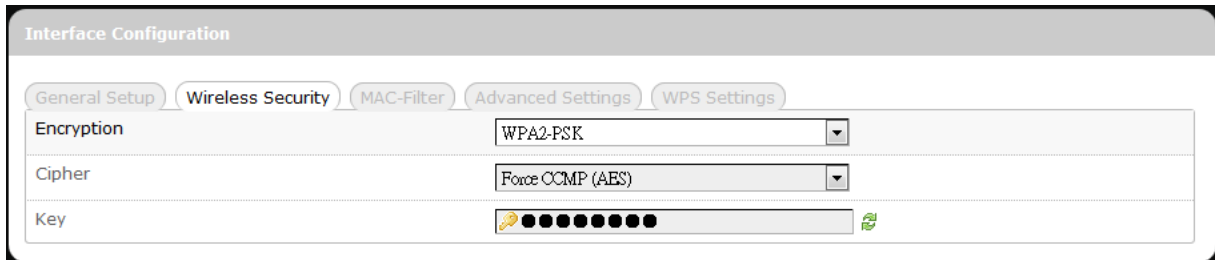

Cipher: Specifies the desired encryption protocol by clicking  and selecting an option from the drop-down list:

*auto* – (Default setting) the system automatically chooses the optimal encryption protocol

*Force CCMP (AES)* – Use CCMP (AES) encryption exclusively (stronger than TKIP)

*Force TKIP* – Use TKIP encryption exclusively

*Force TKIP and CCMP (AES)* – Use TKIP and CCMP (AES) encryption protocols together

Key: Enter a password for accessing this SSID’s wireless network.

#### 5. WPA-PSK/WPA2-PSK Mixed Mode

“WiFi Protected Access I + II – Pre-Shared Key” encryption

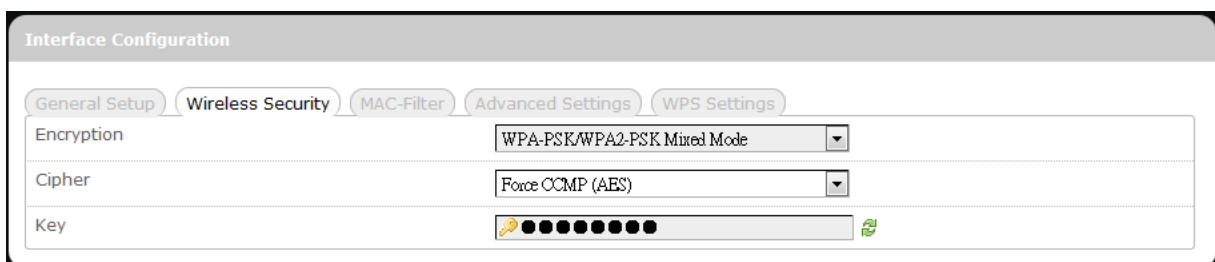

Cipher: Specifies the desired encryption protocol by clicking  and

selecting an option from the drop-down list:

*auto* – (Default setting) the system automatically chooses the optimal encryption protocol

*Force CCMP (AES)* – Use CCMP (AES) encryption exclusively (stronger than TKIP)

*Force TKIP* – Use TKIP encryption exclusively

*Force TKIP and CCMP (AES)* – Use TKIP and CCMP (AES) encryption protocols together

Key: Enter a password for accessing this SSID's wireless network.

## 6. WPA-EAP

“WiFi Protected Access – Extensible Authentication Protocol” encryption

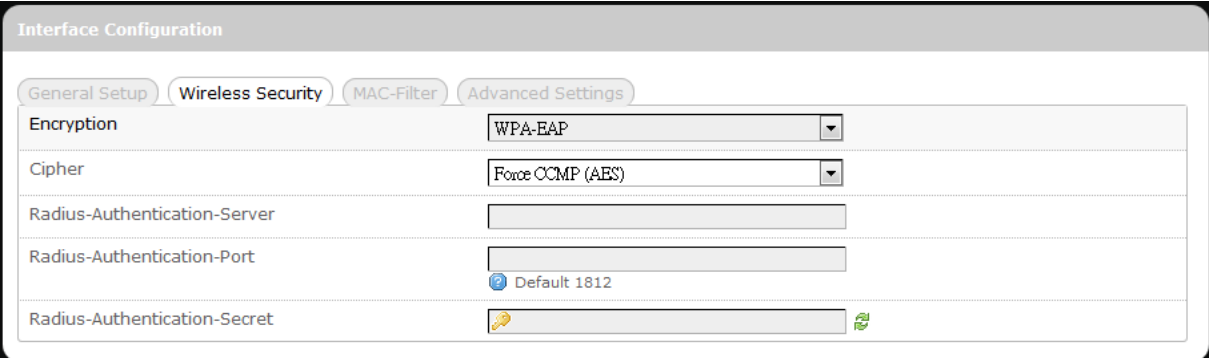

The screenshot shows the 'Interface Configuration' window with the 'Wireless Security' tab selected. The 'Encryption' dropdown menu is set to 'WPA-EAP'. The 'Cipher' dropdown menu is set to 'Force CCMP (AES)'. Below these are input fields for 'Radius-Authentication-Server', 'Radius-Authentication-Port' (with a 'Default 1812' button), and 'Radius-Authentication-Secret' (with a key icon and a green lock icon).

Cipher: Specifies the desired encryption protocol by clicking  and selecting an option from the drop-down list:

*auto* – (default setting) the system automatically chooses the optimal encryption protocol

*Force CCMP (AES)* – Use CCMP (AES) encryption exclusively (stronger than TKIP)

*Force TKIP* – Use TKIP encryption exclusively

*Force TKIP and CCMP (AES)* – Use TKIP and CCMP (AES) encryption protocols together

Radius-Authentication-Server: Enter the name of the RADIUS authentication server.

Radius-Authentication-Port: Enter the port number of the RADIUS



---

authentication port (the default port number is 1812).

Radius-Authentication-Secret: Enter the desired RADIUS secret password.

## 7. WPA2-EAP

“WiFi Protected Access II – Extensible Authentication Protocol” encryption

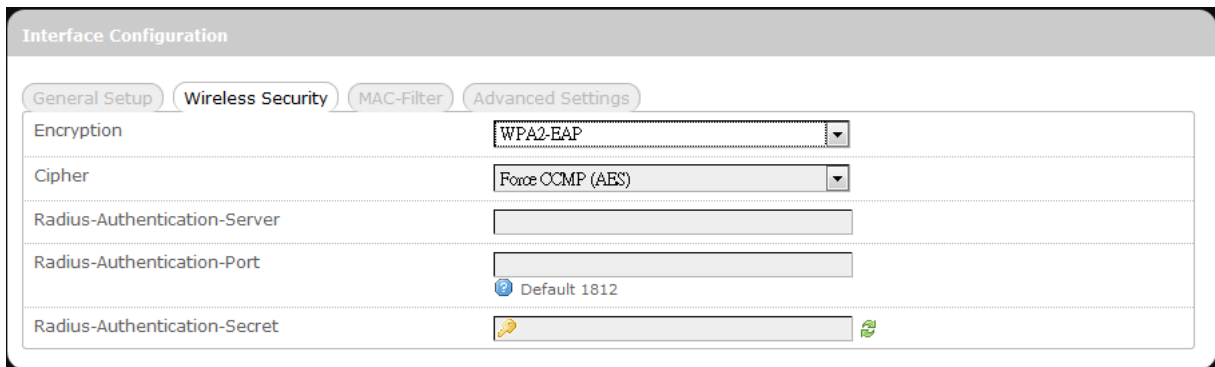

The screenshot shows the 'Interface Configuration' window with the 'Wireless Security' tab selected. The configuration fields are as follows:

Field	Value
Encryption	WPA2-EAP
Cipher	Force CCMP (AES)
Radius-Authentication-Server	
Radius-Authentication-Port	Default 1812
Radius-Authentication-Secret	

Cipher: Specifies the desired encryption protocol by clicking  and selecting an option from the drop-down list:

*auto* – (default setting) the system automatically chooses the optimal encryption protocol

*Force CCMP (AES)* – Use CCMP (AES) encryption exclusively (stronger than TKIP)

*Force TKIP* – Use TKIP encryption exclusively

*Force TKIP and CCMP (AES)* – Use TKIP and CCMP (AES) encryption protocols together

Radius-Authentication-Server: Enter the name of the RADIUS authentication server.

Radius-Authentication-Port: Enter the port number of the RADIUS authentication port (the default port number is 1812).

Radius-Authentication-Secret: Enter the desired RADIUS secret password.

### **MAC-Filter**

MAC-Address Filter:

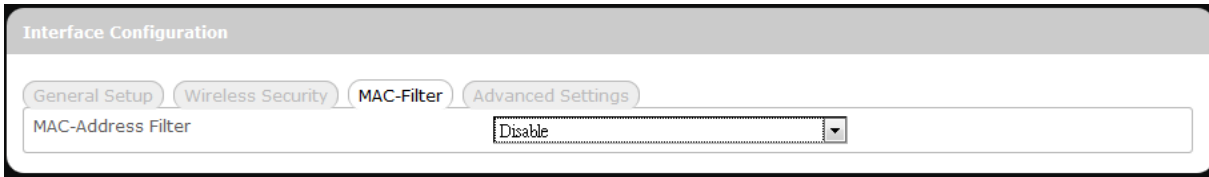

This tab item allows you to selectively allow or block clients from network access. Click  and select an option from the drop-down list:

1. Disable – The MAC address filter is disabled (default option).
2. White list\* – Click  and select a desired MAC address from the drop-down list, or select "-- custom --" and enter a specific client's MAC address.
3. Black list\* – Click  and select an undesired MAC address from the drop-down list, or select "-- custom --" and enter a specific client's MAC address.

- \* To add another MAC address to the list, click  to add a new drop-down list; then repeat the MAC address selection/specification. To remove a MAC address from the list, click .

## Advanced Settings

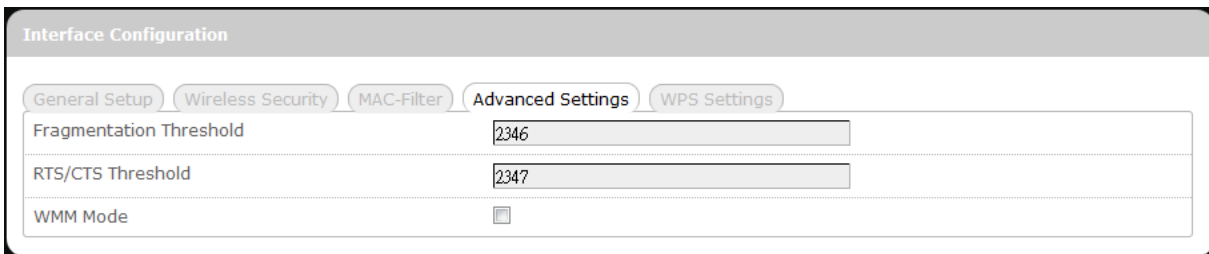

This tab item is for advanced adjustment settings for WiFi connection.

Fragmentation Threshold	Maximum transmittable data packet frame size without frame fragmentation; the default value is 2346
RTS/CTS Threshold	Defines Request-To-Send (transmitter) and Clear-To-Send (receiver) control packet size; the default value is 2347
WMM Mode	Enables or disables Wi-Fi Multimedia Mode, which gives multimedia data contents (voice, video, and audio) higher priority over wireless networks. The

---

default setting of WMM Mode is Disabled.

## WPS Settings

### WiFi Protected Setup Settings

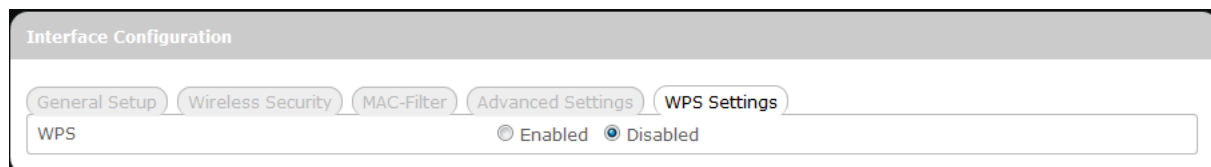

This tab item appears when 'Encryption' in "Wireless Security" is set to one of the following: **WPA-PSK**, **WPA2-PSK**, or **WPA-PSK/WPA2-PSK Mixed Mode**.

**WPS:** To enable the WPS button for quick WiFi connection setup, click 'Enabled', and 2 additional items will appear: Mode and Start.

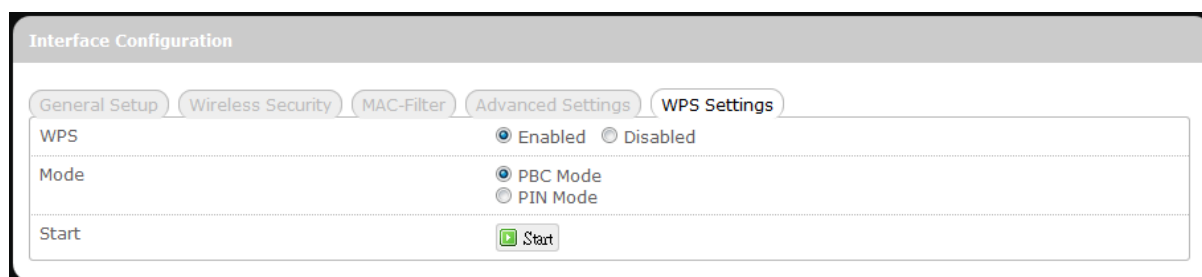

**Mode:** Specifies WPS setup mode

**PBC Mode –** Push Button Configuration Mode  
(Note: To use this setup method, the client must have a WPS button configured to PBC Mode.)

**PIN Mode –** Personal Identification Number Mode  
(Note: To use this setup method, the client must have a WPS button configured to PIN Mode.)

After choosing PIN Mode, an additional text box item "PIN Code" will appear.

**PIN Code:** This text box item appears when 'Mode' is set to "PIN Mode".

Enter the 8-digit alphanumeric PIN in the text box. This PIN

must match the PIN of the router client.

Interface Configuration

General Setup Wireless Security MAC-Filter Advanced Settings WPS Settings

WPS  Enabled  Disabled

Mode  PBC Mode  PIN Mode

PIN Code

Start

If the PIN entered is invalid, the text color will become red with  on the right.



Whenever the PIN entered becomes valid, the text color will be black without  on the right.

**Start:** After setting up WPS Mode (PBC or PIN), click the router client's corresponding hardware/software WPS button (actual router client hardware/software WPS button behavior will depend on router client manufacturer's design).

Click  or press-and-hold the router's physical SS/WPS/Reset button for just over 3 seconds to start the WPS process.

# Firewall

## Single Port Forward

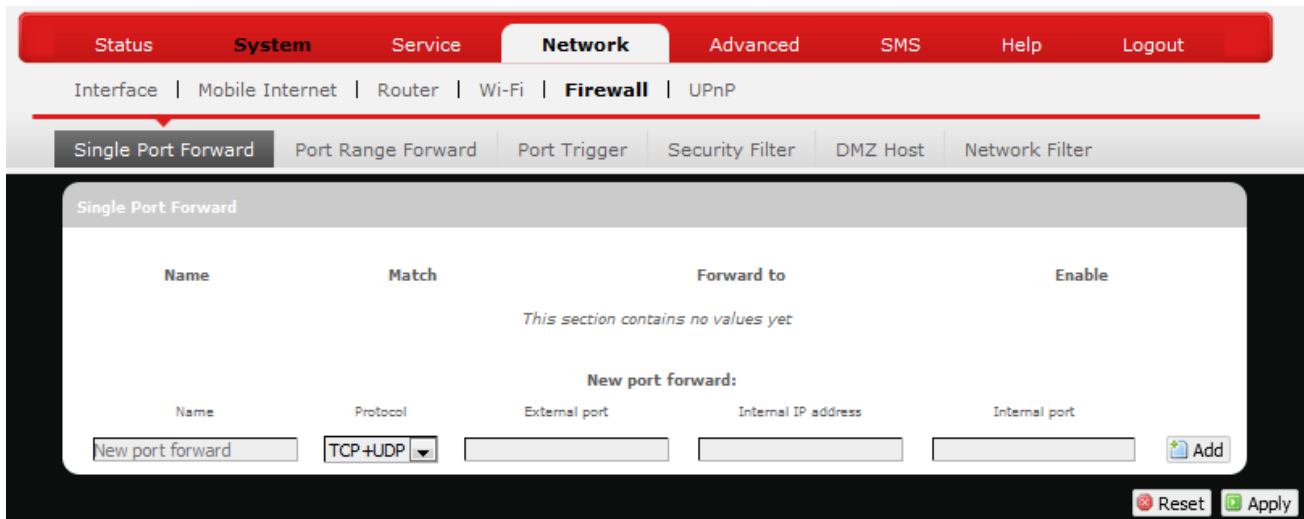

### Single Port Forward

Port Forwarding allows you to set up public services on your network, such as web servers, ftp servers, e-mail servers, and other specialized Internet applications.

To forward a single port:

A screenshot of the 'New port forward:' form. The fields are filled with example values: 'Name' is 'LureFWD1', 'Protocol' is 'TCP+UDP' (selected in the dropdown), 'External port' is '9001', 'Internal IP address' is '192.168.1.194', and 'Internal port' is '9001'. The 'Add' button is visible on the right.



1. **Name:** Enter an application name for this port forwarding rule.
2. **Protocol:** Click  and select a protocol from the drop down list – *TCP+UDP* (default), *TCP*, *UDP*, or *Other...*
3. **External port:** Enter the port number of the external port used by the server or Internet application. Afterward, this port number will be echoed to the text box of “Internal port”.
4. **Internal IP address:** Click  and select an IP address from drop-down list, or select “--custom--” and enter IP address in text box.
5. **Internal port:** This text box will automatically receive port number entered in the text box of “External port”, or you can enter your own port

---

number in the same text box.

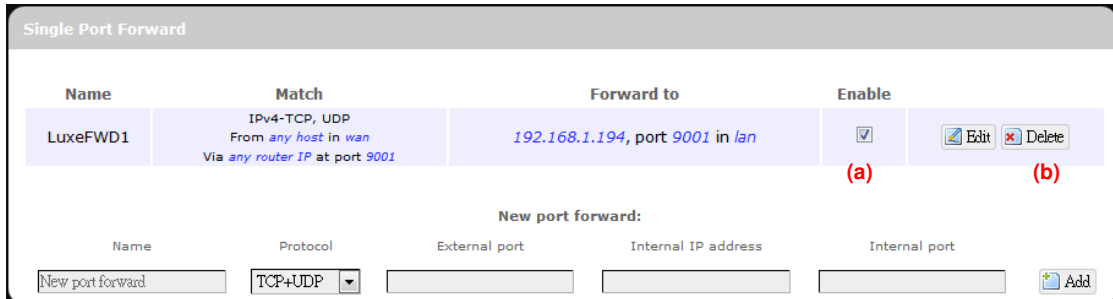
- Click . The port forwarding rule you have just entered will be added to the Port Forwards list.





Name	Match	Forward to	Enable	
LuxeFWD1	IPv4-TCP, UDP From any host in wan Via any router IP at port 9001	192.168.1.194, port 9001 in lan	<input checked="" type="checkbox"/>	 

(a) (b)

New port forward:

Name	Protocol	External port	Internal IP address	Internal port	
<input type="text" value="New port forward"/>	<input type="text" value="TCP+UDP"/>	<input type="text"/>	<input type="text"/>	<input type="text"/>	

In the status area, the message **Unapplied Change** may appear next to “Operator Name” to indicate configuration changes temporarily stored in the router.

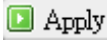
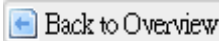
- More rules can be added to the Port Forwards list by repeating Steps 1-6.
- (a) To enable or disable a Port Forwards list rule, click its check box under ‘Enable’.
- (b) To remove any Port Forwards rule, click its corresponding  button.
- To edit a particular Port Forwards rule in detail, click its corresponding  button, and the rule’s associated configuration page (much more flexible and detailed than express settings in Steps 1-5) will appear. After making any changes, click . Finally click  to exit this configuration page.

Rule is enabled	<input checked="" type="checkbox"/> Disable
Name	LuxeFWD1
Protocol	TCP+UDP
External port	9001 <small>Match incoming traffic directed at the given destination port or port range on this host</small>
Internal IP address	192.168.1.194 (User-NE2) <small>Redirect matched incoming traffic to the specified internal host</small>
Internal port	9001 <small>Redirect matched incoming traffic to the given port on the internal host</small>
Enable NAT Loopback	<input checked="" type="checkbox"/>

**Note:** Numerical and text values shown in the illustrative examples are for demonstration purposes only and are not for actual operation.

## Port Range Forward

Status
System
Service
Network
Advanced
SMS
Help
Logout

Interface | Mobile Internet | Router | Wi-Fi | Firewall | UPnP

Single Port Forward | Port Range Forward | Port Trigger | Security Filter | DMZ Host | Network Filter

Port Range Forward

Name	Match	Enable
This section contains no values yet		

**Port Range Forward**



Name	Protocol	Start Port	End Port	IP Address	
<input type="text"/>	TCP+UDP	<input type="text"/>	<input type="text"/>	<input type="text"/>	<input type="button" value="Add"/>

### Port Range Forward

Port Range Forward allows you to set up public services on your network, such as web servers, ftp servers, e-mail servers, and other specialized Internet applications.



To forward a port range:

Port Range Forward					
Name	Protocol	Start Port	End Port	IP Address	
<input type="text" value="LuxePRF1"/>	TCP+UDP	<input type="text" value="1010"/>	<input type="text" value="8080"/>	<input type="text" value="192.168.1.194"/>	<input type="button" value="Add"/>

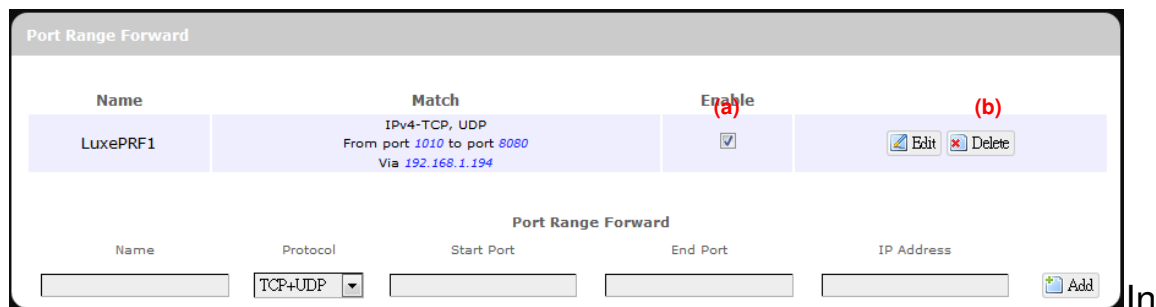
1. **Name:** Enter an application name for this port range forwarding rule.
2. **Protocol:** Click  and select a protocol from the drop down list – *TCP+UDP* (default), *TCP*, *UDP*, or *Other...*
3. **Port Range Forward:** Specify the range of port forwarding by entering the **Start Port** number and the **End Port** number.
4. **IP address:** Enter the IP address of the PC running the specific application.
5. Click . The port range forwarding rule you have just entered will be added to the Port Range Forward list.

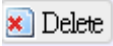

In the status area, the message **Unapplied Change** may appear next to “Operator Name” to indicate configuration changes temporarily stored in the router.

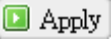
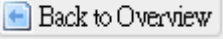
6. More rules can be added to the Port Range Forward list by repeating Steps 0-0.
7. (a) To enable or disable a Port Forwards list rule, click its check box under ‘Enable’.
- (b) To remove any Port Forwards rule, click its corresponding  button.
8. To edit a particular Port Forwards rule in detail, click its corresponding  button, and the rule’s associated configuration page (more flexible and detailed than express settings in Steps 0-0) will appear. After making any changes, click . Finally click  to exit this configuration page.



Rule is enabled	<input checked="" type="checkbox"/> Disable
Name	LuxePRF1
Protocol	TCP+UDP
Forward start port	1010 <small>Redirect matched incoming traffic to the given port on the internal host</small>
Forward end port	8080 <small>Redirect matched incoming traffic to the given port on the internal host</small>
Internal IP address	192.168.1.194 (User-NB2) <small>Redirect matched incoming traffic to the specified internal host</small>

**Note:** Numerical and text values shown in the illustrative examples are for demonstration purposes only and are not for actual operation.

## Port Trigger

Status System Services Network SMS Help Logout

Interfaces | Mobile Internet | Router | Wi-Fi | Firewall | Diagnostics | UPnP

Single Port Forward | Port Trigger | Security Filter | DMZ Host | IP Filtering | Port Range Forward

### Port Trigger

Name	Trigger Range	Forward Range	Enable
<i>This section contains no values yet</i>			

		Triggered Range		Forwarded Range		
Name	Protocol	Start Port	End Port	Start Port	End Port	
<input type="text" value="New port trigger"/>	<input type="text" value="TCP+UDP"/>	<input type="text"/>	<input type="text"/>	<input type="text"/>	<input type="text"/>	<input type="button" value="Add"/>

### Port Trigger

Port Triggering allows the Router to watch outgoing data for specific port numbers. The Router remembers the IP address of the computer that sends the matching data, so that when the requested data returns through the Router, the data is pulled back to the proper computer by way of IP address and port mapping rules.

To add a new Port Triggering rule:

Name	Protocol	Triggered Range		Forwarded Range	
		Start Port	End Port	Start Port	End Port
LuxeTrig1	TCP+UDP	10	80	10	80

1. **Name:** enter an application name for this port triggering rule.
2. **Protocol:** click  and select a protocol from the drop down list – *TCP+UDP* (default), *TCP*, *UDP*, or *Other...*
3. **Triggered Range:** enter the **Start Port** and **End Port** for the triggered port number range of the Internet application (please check its documentation for the port number(s) needed).
4. **Forwarded Range:** enter the **Start Port** and **End Port** for the forwarded port number range of the Internet application (please check its documentation for the port number(s) needed).
5. Click . The port triggering rule you have just entered will be added to the Port Triggering list.

The screenshot shows a 'Port Trigger' window with a table of rules. The first rule is 'LuxeTrig1' with protocol 'IPv4-TCP, UDP', triggered range 'Start port 10 to port 80', and forward range 'Open port 10 to port 80'. It is enabled (checkbox checked) and has 'Edit' and 'Delete' buttons. Red labels '(a)' and '(b)' point to the 'Enable' checkbox and the 'Delete' button respectively. Below the table is an 'Add' form with fields for Name, Protocol, Triggered Range (Start/End Port), and Forwarded Range (Start/End Port), and an 'Add' button.

In the status area, the message **Unapplied Change** may appear next to “Operator Name” to indicate configuration changes stored in the router.

6. More rules can be added to the Port Triggering list by repeating Steps 1-5.
7. (a) To enable or disable a Port Forwards list rule, click its check box under ‘Enable’.
- (b) To remove any Port Triggering rule, click its corresponding  button.
8. To edit a particular Port Triggering rule in detail, click its corresponding  button, and the rule’s associated configuration page (more flexible and detailed than express settings in Steps 1-4) will appear. After making

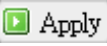
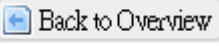
any changes, click . Finally click  to exit this configuration page.

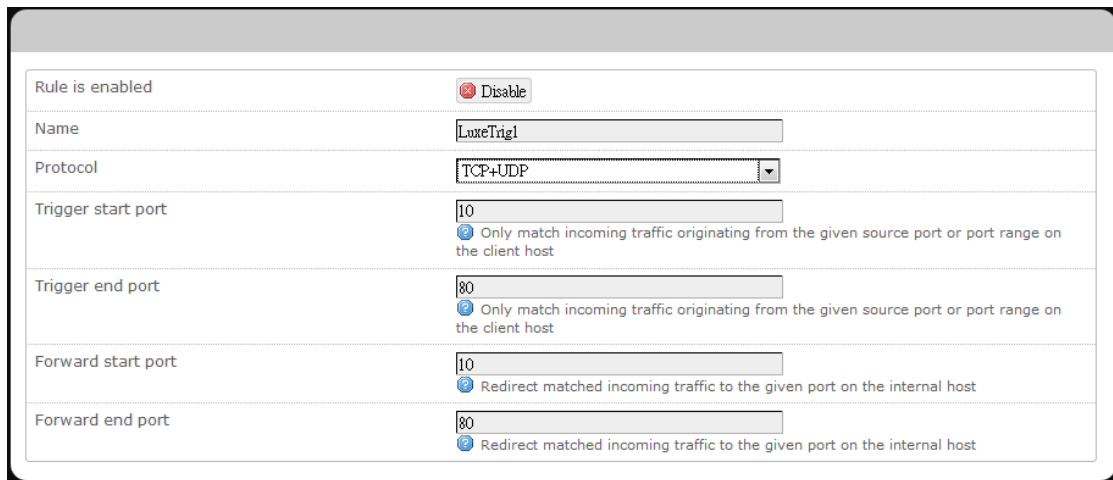

Rule is enabled	<input checked="" type="checkbox"/> Disable
Name	LuxeTrig1
Protocol	TCP+UDP
Trigger start port	10 <small>Only match incoming traffic originating from the given source port or port range on the client host</small>
Trigger end port	80 <small>Only match incoming traffic originating from the given source port or port range on the client host</small>
Forward start port	10 <small>Redirect matched incoming traffic to the given port on the internal host</small>
Forward end port	80 <small>Redirect matched incoming traffic to the given port on the internal host</small>

**Note:** Numerical and text values shown in the illustrative examples are for demonstration purposes only and are not for actual operation.

## Security Filter

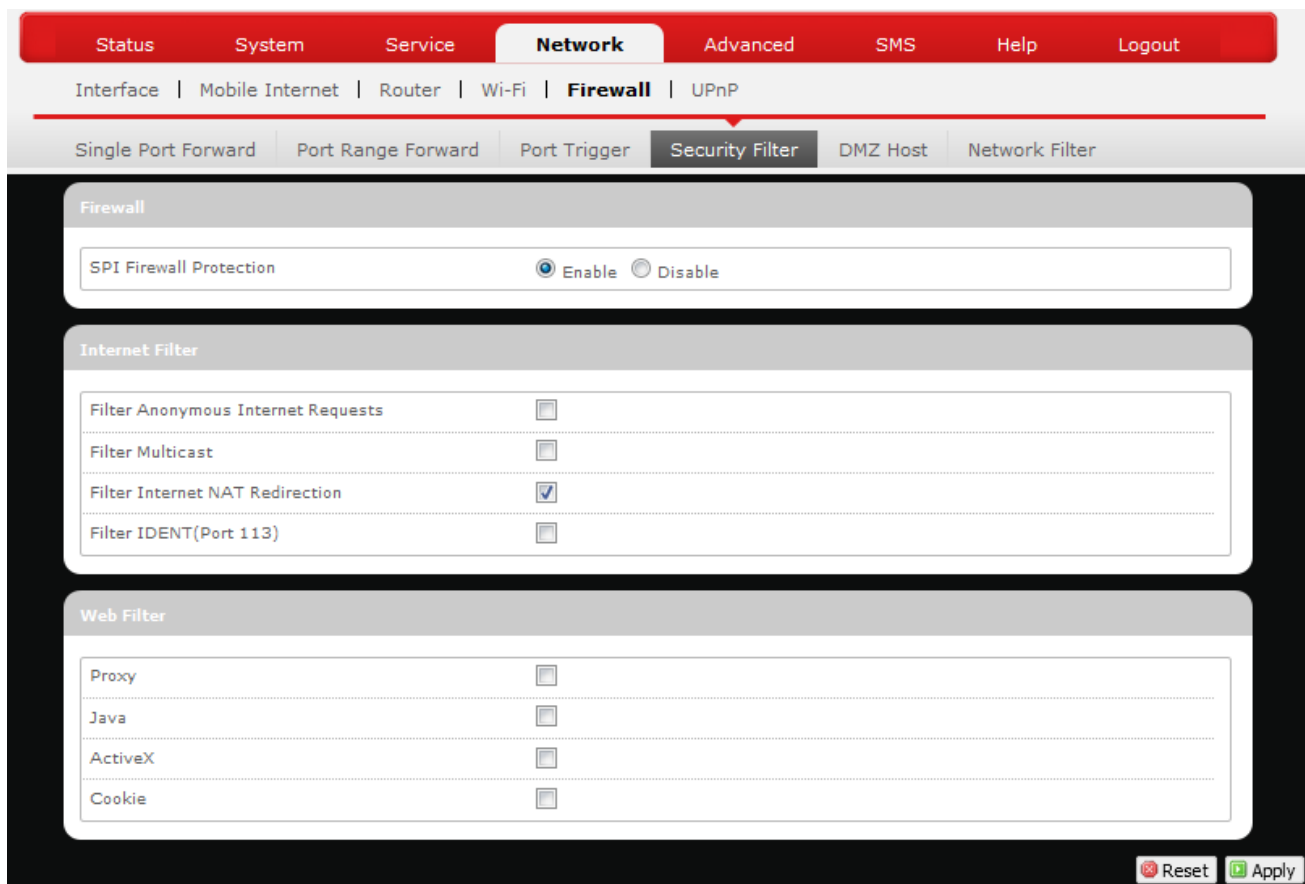

Navigation: Status | System | Service | **Network** | Advanced | SMS | Help | Logout

Sub-navigation: Interface | Mobile Internet | Router | Wi-Fi | **Firewall** | UPnP

Options: Single Port Forward | Port Range Forward | Port Trigger | **Security Filter** | DMZ Host | Network Filter

**Firewall**

SPI Firewall Protection  Enable  Disable

**Internet Filter**

Filter Anonymous Internet Requests

Filter Multicast

Filter Internet NAT Redirection

Filter IDENT(Port 113)



**Web Filter**

Proxy

Java

ActiveX

Cookie

---

Here you can make **Firewall**, **Internet Filter**, and **Web Filters** adjustments for network security.

## Firewall

**SPI Firewall Protection:** Enable or Disable Stateful Packet Inspection (SPI) feature of the firewall. The default setting is 'Enable'.

## Internet Filter

**Filter Anonymous Internet Requests:** This filter blocks anonymous internet requests from outside network. The default setting is 'disabled'.

**Filter Multicast:** Multicasting allows for multiple transmissions to specific recipients at the same time, i.e. the Router allows IP multicast packets to be forwarded to the appropriate computers.

To allow multicasting, disable "Filter Multicast" (this is the default setting).

To block multicasting, enable "Filter Multicast".

**Filter Internet NAT Redirection:** This filter blocks local resource access via NAT (Network Address Translation) redirection (i.e. external address) from other local computers. The default setting is 'enabled'.

**Filter IDENT (Port113):** This feature keeps Port 113 from being scanned by devices outside of your local network. The default setting is 'disabled'.

## Web Filters

Using the Web Filters feature, you may enable up to four specific filtering methods.

**Proxy:** Use of WAN proxy servers may compromise the Router's security. Select this option to disable access to any WAN proxy servers.

**Java:** Java is a programming language for websites. Select this option to disable Java. If you disable Java, you run the

risk of not having access to Internet sites created using this programming language.

**ActiveX:** ActiveX is a programming language for websites. Select this option to disable ActiveX. If you disable ActiveX, you run the risk of not having access to Internet sites created using this programming language.

**Cookies:** A cookie is data stored on your PC and used by Internet sites when you interact with them. Select this option to disable cookies.

## DMZ Host

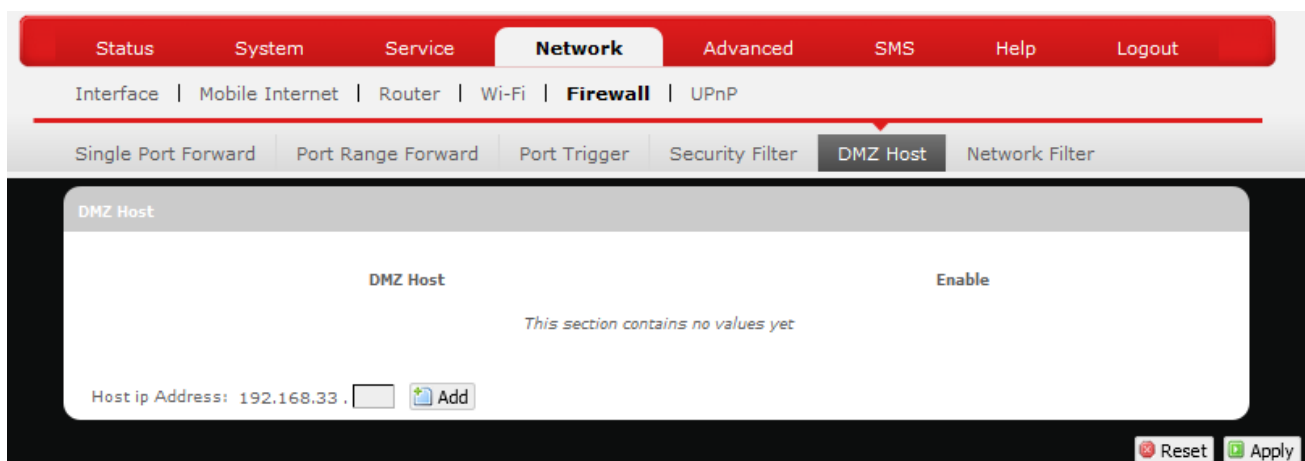



When a firewall is used, it is sometimes necessary to place some clients (for example Internet games, video conferencing, or VPN connections) outside of the firewall while leaving the others protected. You can do this using a Demilitarized Zone (DMZ). This DMZ Host feature allows you to specify the IP address of the computers that are placed outside the firewall of your network.

In the text box, enter the last 3 digits of the DMZ host address (the prefix is 192.168.1 for this router), and then click .

Host ip Address: 192.168.1.  

The host IP address will be added to the DMZ Host list, which can be further disabled or enabled by clicking the 'Enable' checkbox. To remove this DMZ

Host, click . After setting up the DMZ host, click .

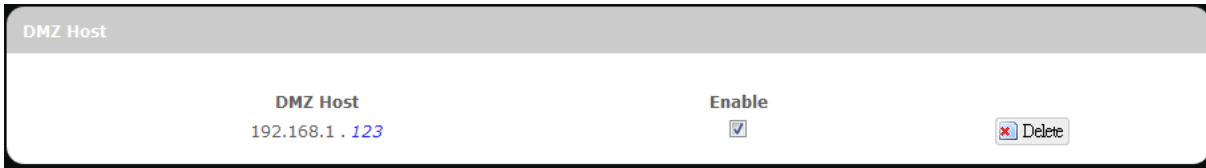

## Network Filtering

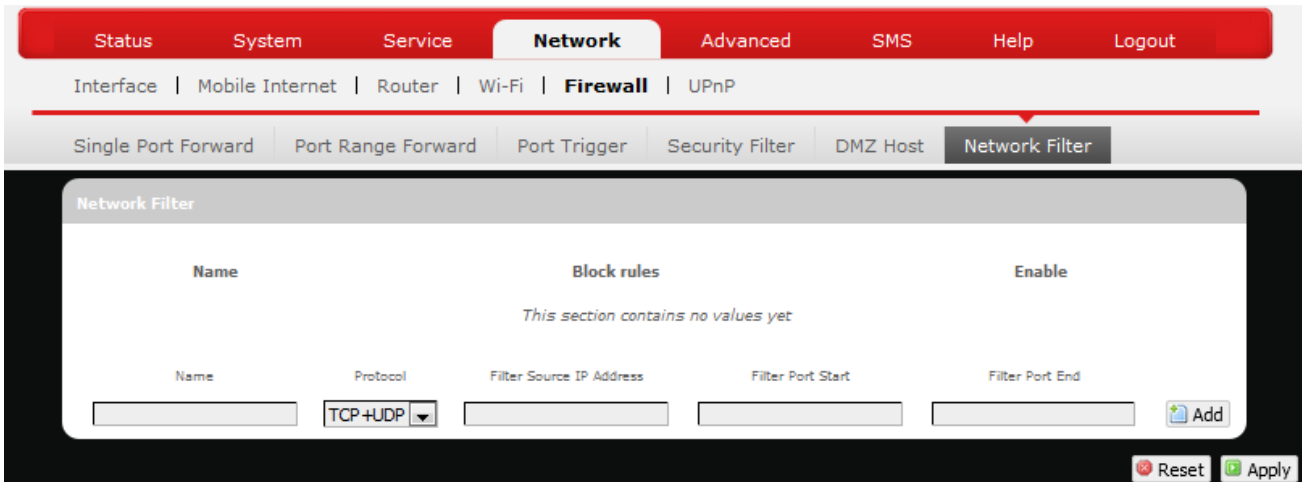

### Network Filtering

Network Filtering allows the Router to discard data from certain IP addresses. To add a new IP filtering rule:

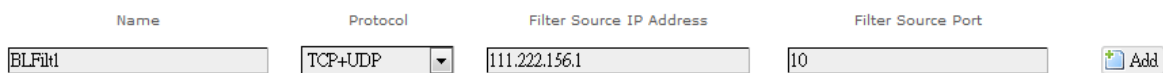

1. **Name:** Enter an application name for this IP filtering rule.
2. **Protocol:** Click  and select a protocol from the drop down list – *TCP+UDP* (default), *TCP*, *UDP*, or *Other...*
3. **Filter Source IP Address:** Enter the source IP address to be filtered. The text color will turn red with  on the right for any invalid IP address entered (e.g.  ). When the IP address entered becomes valid, the text color changes back to black without  on the right (e.g. ).
4. **Filter Source Port:** Enter the source port number to be filtered.

- Click . The Network filtering rule you have just entered will be added to the IP Filtering list.

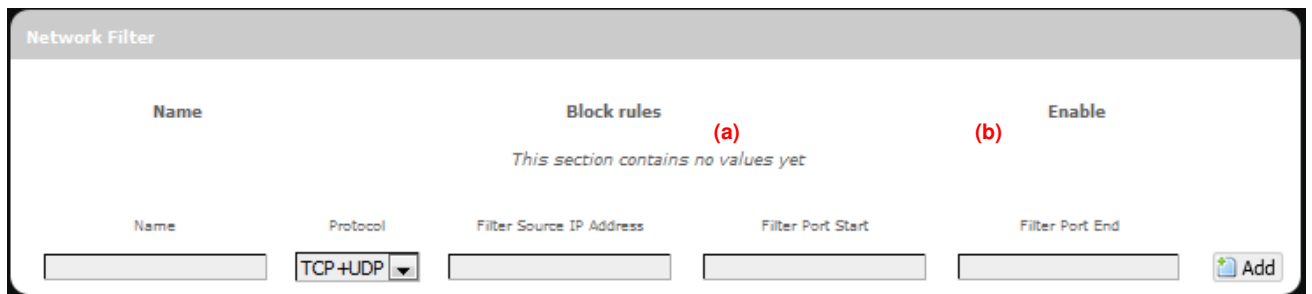

In the status area, the message **Unapplied Change** may appear next to “Operator Name” to indicate configuration changes stored in the router.

- More rules can be added to the network filtering list by repeating Steps 1-5.

- (a) To enable or disable an network filtering list rule, click its check box under ‘Enable’.

(b) To remove any Port Triggering rule, click its corresponding  button.

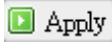
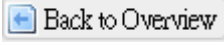
- To edit a particular network filtering rule in detail, click its corresponding  button, and the rule’s associated configuration page (more flexible and detailed than express settings in Steps 1-4) will appear. After making any changes, click . Finally click  to exit this configuration page.

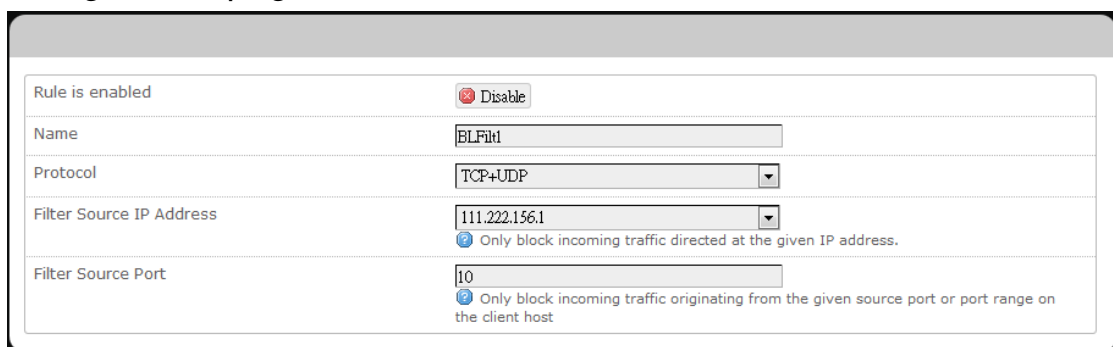

**Note:** Numerical and text values shown in the illustrative examples are for demonstration purposes only and are not for actual operation.

## Port Range Forward

The screenshot shows a web interface with a red navigation bar containing 'Status', 'System', 'Service', 'Network', 'Advanced', 'SMS', 'Help', and 'Logout'. Below the navigation bar, there is a breadcrumb trail: 'Interface | Mobile Internet | Router | Wi-Fi | Firewall | UPnP'. Underneath, there are tabs for 'Single Port Forward', 'Port Range Forward', 'Port Trigger', 'Security Filter', 'DMZ Host', and 'Network Filter'. The 'Port Range Forward' tab is active. The main content area is titled 'Port Range Forward' and contains a table with columns 'Name', 'Match', and 'Enable'. Below the table, there is a form for adding a new entry with fields for 'Name', 'Protocol' (set to 'TCP+UDP'), 'Start Port', 'End Port', and 'IP Address'. There is an 'Add' button and 'Reset' and 'Apply' buttons at the bottom right.

## UPnP

The screenshot shows a web interface with a red navigation bar containing 'Status', 'System', 'Services', 'Network', 'SMS', 'Help', and 'Logout'. Below the navigation bar, there is a breadcrumb trail: 'Interfaces | Mobile Internet | Router | Wi-Fi | Firewall | Diagnostics | UPnP'. Underneath, there is a section titled 'UPnP settings' with a form containing a label 'Start UPnP service' and two radio buttons: 'Enable' and 'Disable'. The 'Disable' radio button is selected. There are 'Reset', 'Save', and 'Apply' buttons at the bottom right.

Universal Plug and Play – Allows wired and wireless network devices to discover each other and establish network services.

## UPnP Settings

Here you can 'Enable' or 'Disable' the UPnP service.



---

# Advanced

## *Diagnostics*

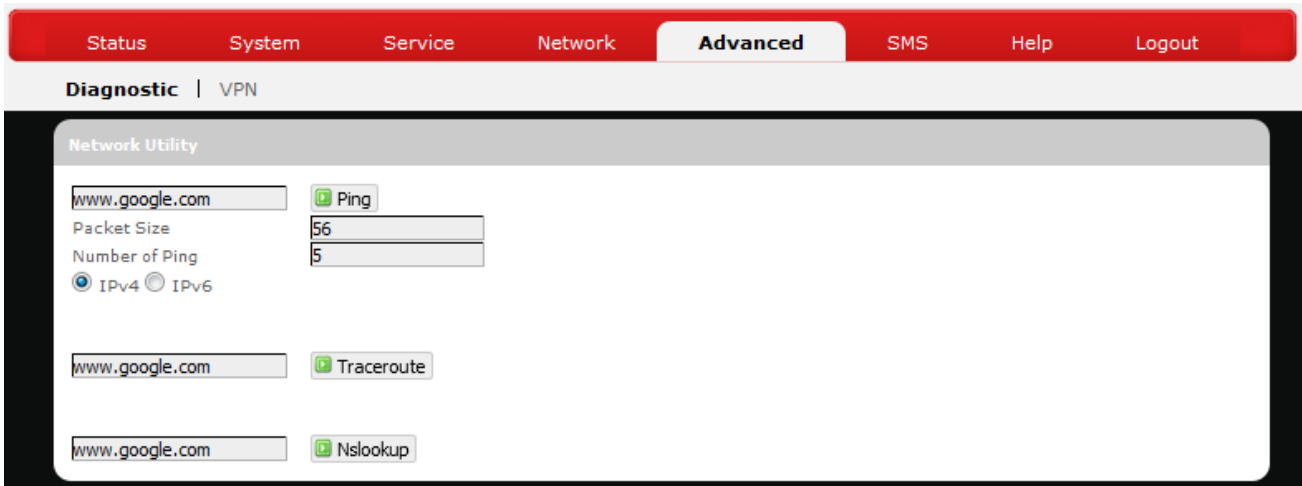

This menu contains tools for effective network analysis and troubleshooting.

## Network Utilities

### *Ping*

A close-up of the 'Ping' utility form. It features a text input field with 'www.google.com', a 'Ping' button, and two more input fields: 'Packet Size' with '56' and 'Number of Pings' with '5'. At the bottom, there are two radio buttons: 'IPv4' (selected) and 'IPv6'.

This feature allows you to check the status of a connection.

1. In the text box next to , enter the IP address or URL that you want to ping, and then select its corresponding internet protocol by clicking either the IPv4 or IPv6 radial button.
2. In the text box of "Packet Size", enter the desired value (default packet size is 56).
3. In the text box of "Number of Pings", enter the number of times you wish to ping (default value is 5).

- 
4. Click  to begin the connection status check. 'Ping' messages will appear below.

### ***Traceroute***



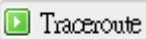
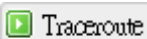

This feature allows you to check the performance of a connection.

1. In the text box next to , enter the IP address or URL that you want to trace route, and then click  to start the performance test. 'Traceroute' messages will appear below.

### ***NS Lookup***



This feature allows you to retrieve name server information.

1. In the text box next to , enter the IP address or URL that you want to trace route, and then click  to get name server information. 'Nslookup' messages will appear below.

## **SMS**

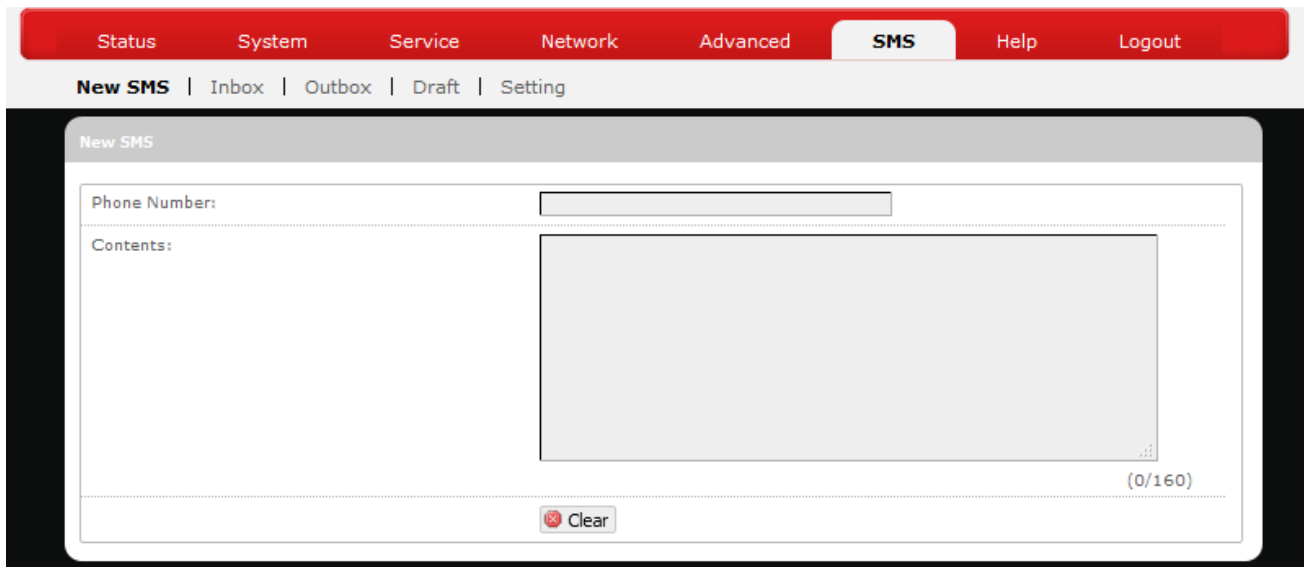

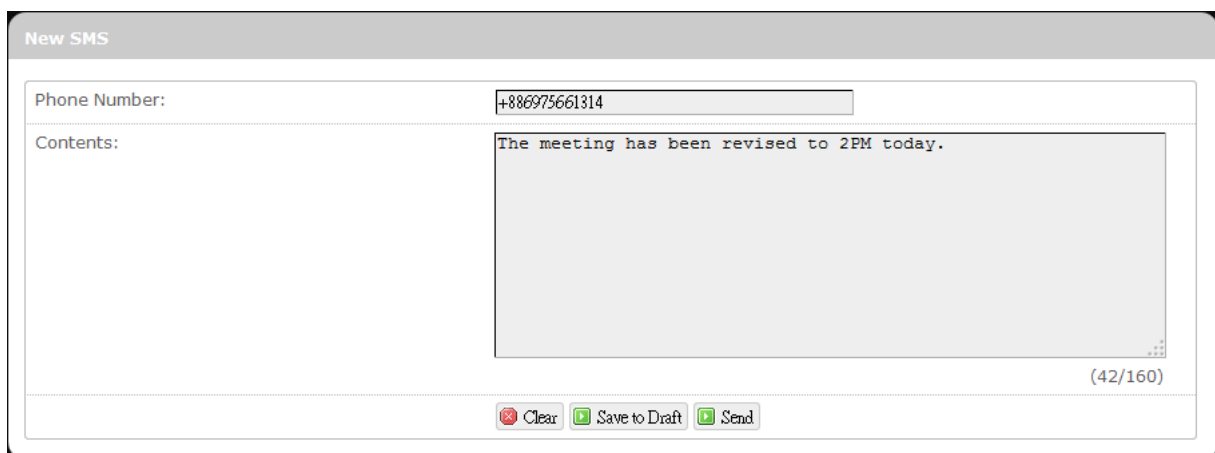

Short Message Service – Allows mobile phones and network devices to exchange short text messages.

## New SMS



Here you can write and send a new SMS message. Enter the recipient's phone number in the field *Phone number*. Enter message texts in the field *Contents*.

To erase written contents and start over again, click  **Clear**. To save written contents as a draft for later use, click  **Save to Draft**. When you are ready to send the message, click  **Send**. A confirmation message will appear if the SMS message is sent successfully.

---

Send Success

OK

## Inbox

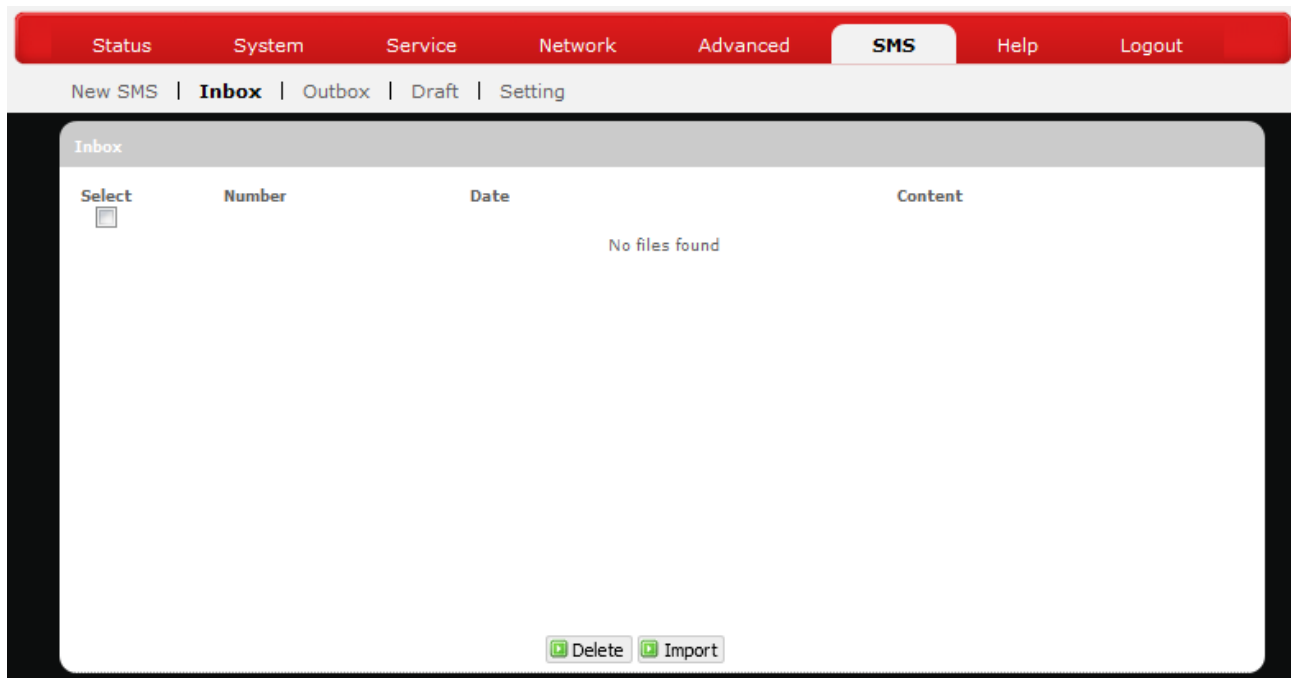

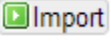
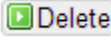
Here you can receive and read incoming SMS messages. To get messages from the server, click . To remove unwanted messages, select messages to delete and click .

## Outbox

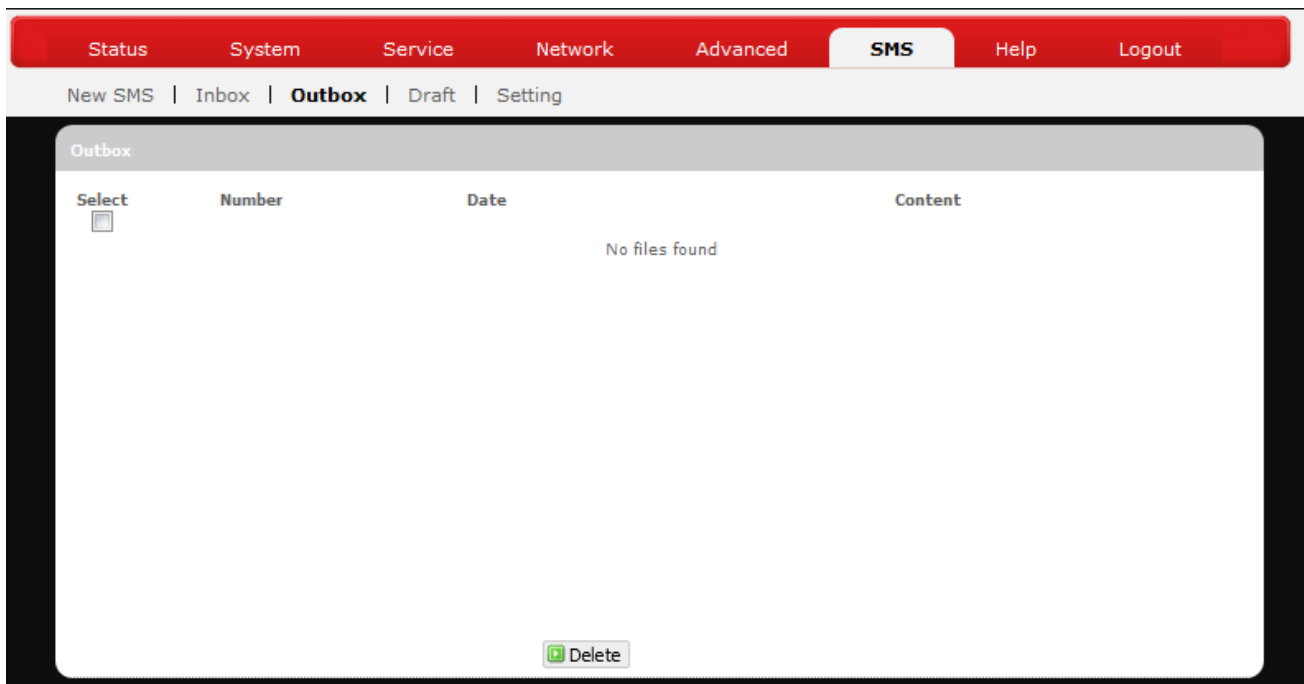

Here you can see SMS messages that have been sent out.

To forward a particular SMS message, check only the message of interest without checking others.

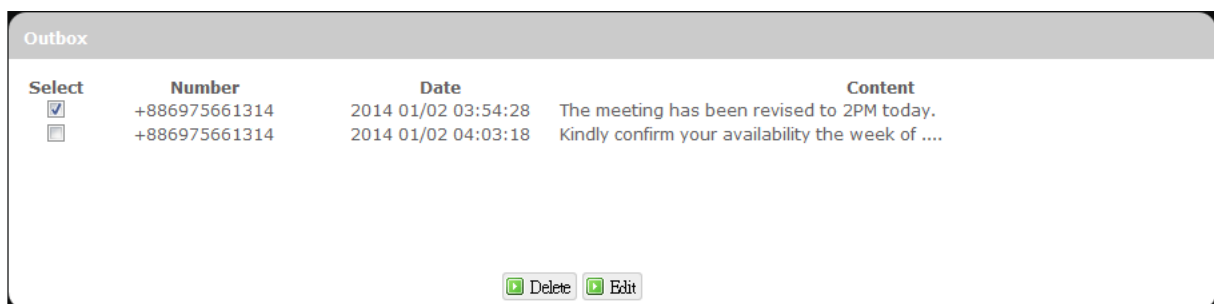

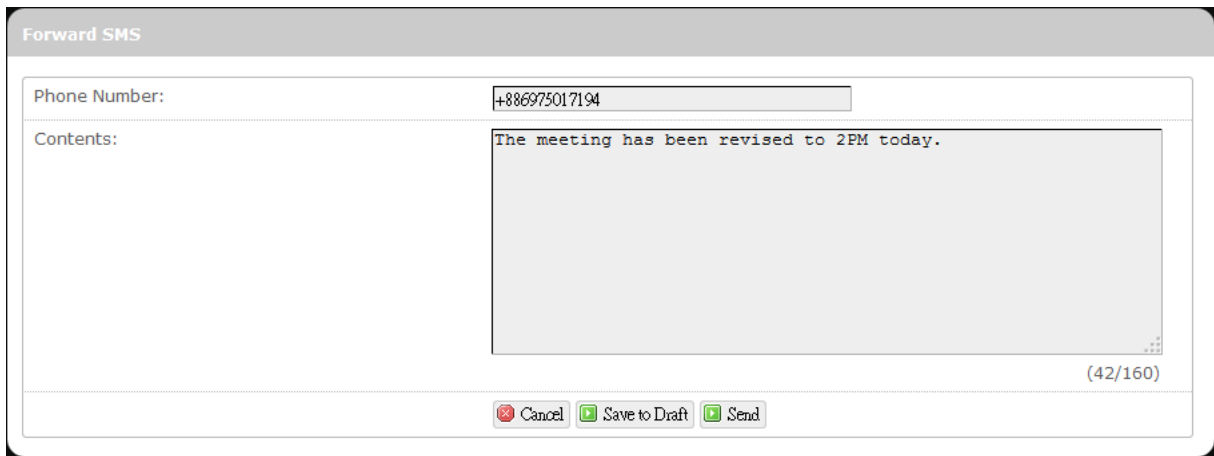

Click  .



Forward SMS

Phone Number: +886975017194

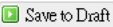
Contents: The meeting has been revised to 2PM today. (42/160)

An additional configuration item *Forward SMS* will appear on top of the configuration item *Outbox*. If necessary, modify the recipient's phone number in the field *Phone number* or modify message texts in the field *Contents*. To

cancel message forwarding, click  . To save written contents as a draft

for later use, click  . When you are ready to forward the message,

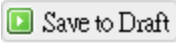
click  .

To remove SMS messages from Outbox, check the messages to remove.

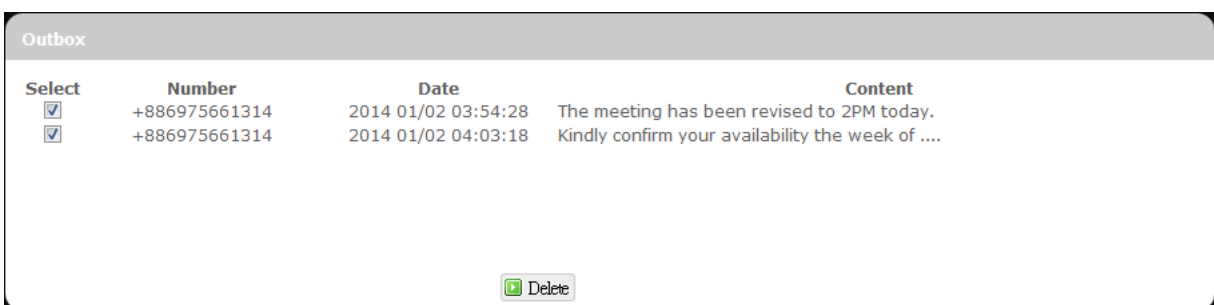

Outbox

Select	Number	Date	Content
<input checked="" type="checkbox"/>	+886975661314	2014 01/02 03:54:28	The meeting has been revised to 2PM today.
<input checked="" type="checkbox"/>	+886975661314	2014 01/02 04:03:18	Kindly confirm your availability the week of ....



Click  .

## **Draft**

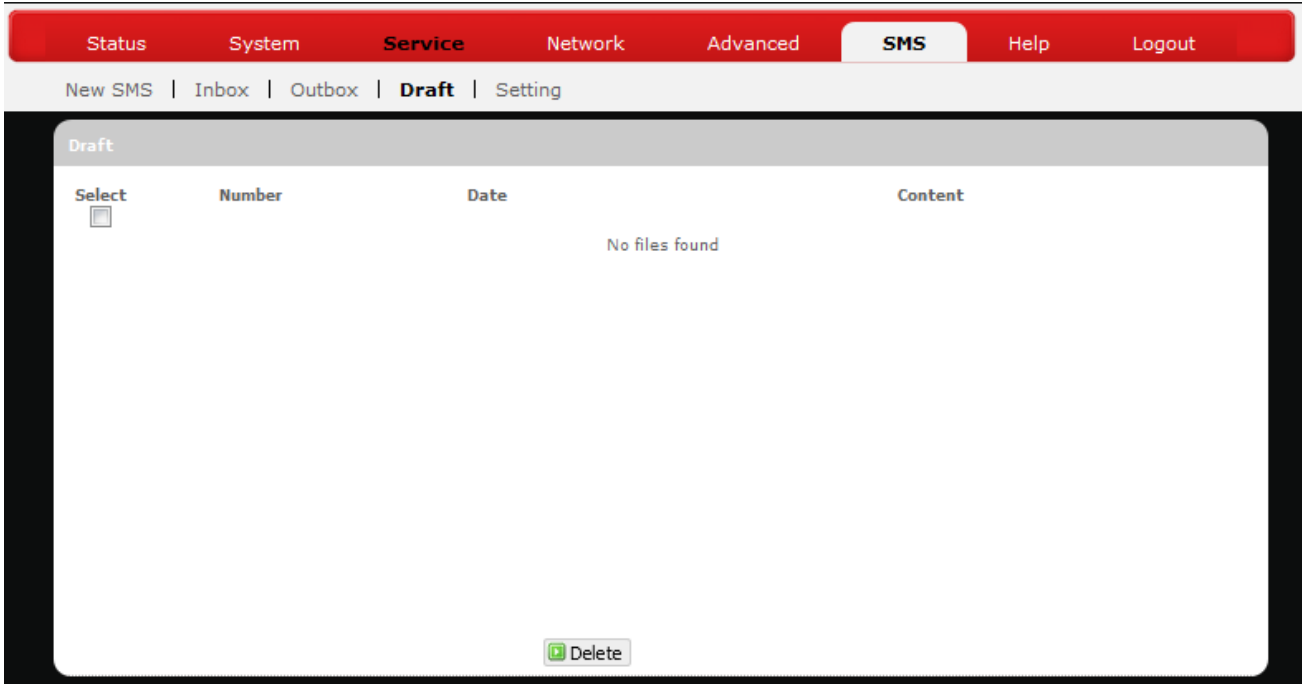

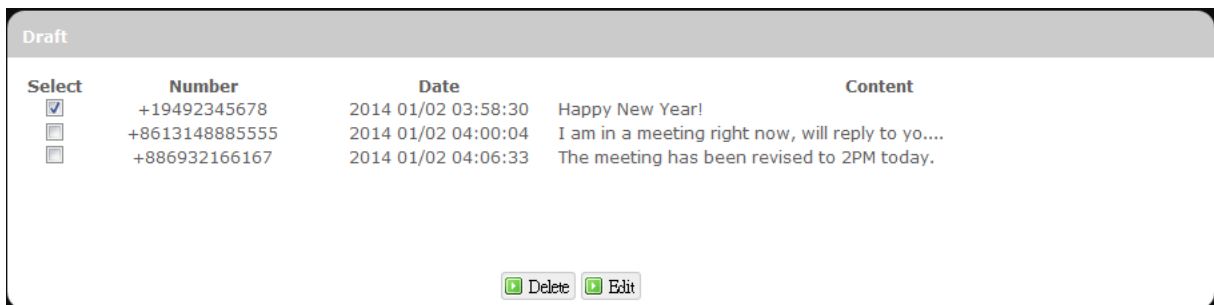

Here you can review and send out SMS messages drafts that have been previously saved.

To send a particular SMS draft message, check only the message of interest without checking others.



Click  .

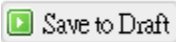

An additional configuration item *Edit SMS* will appear on top of the configuration item *Draft*. If necessary, modify the recipient's phone number in the field *Phone number* or modify message texts in the field *Contents*. To cancel sending out the SMS draft message, click . To save written contents as a draft for later use, click . When you are ready to send the SMS draft message, click .

To remove SMS draft messages from the draft list, check messages to remove.

Select	Number	Date	Content
<input checked="" type="checkbox"/>	+19492345678	2014 01/02 03:58:30	Happy New Year!
<input checked="" type="checkbox"/>	+8613148885555	2014 01/02 04:00:04	I am in a meeting right now, will reply to yo....
<input checked="" type="checkbox"/>	+886932166167	2014 01/02 04:06:33	The meeting has been revised to 2PM today.

Click .

## Setting

Status System Service Network Advanced **SMS** Help Logout

New SMS | Inbox | Outbox | Draft | **Setting**

Setting

Service Center Address: +886931000099

Clear Save

Backup

Backup SMS to client: Export

Recover SMS from client: 瀏覽... 未選擇檔案。 Import



Here you can configure settings for service center and SMS backup.

## Setting

Setting

Service Center Address: +886932400851

Clear Save

Enter the service center phone number in the field *Service Center Address* and click . To clear current phone number and enter a new one, click .

## Backup

Backup

Backup SMS to client: Export

Recover SMS from client: Browse... No file selected. Import

---

To backup SMS messages to your local computer, click  in the field *Backup SMS to client*.

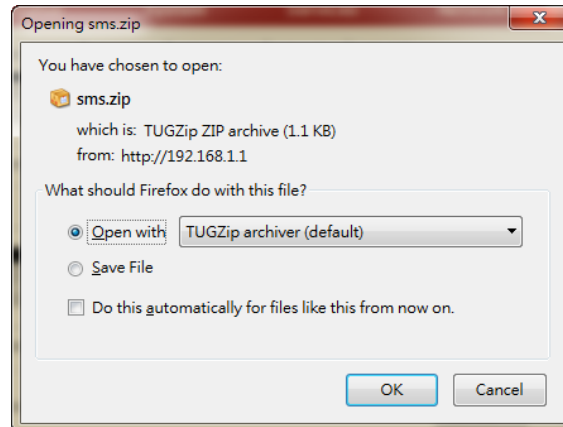

Choose **Save File**, click **OK**, and follow directions on the screen to save SMS messages on your local computer as a packed ZIP file.

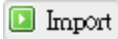
To recover SMS messages from your local computer, click **Browse** in the field *Recover SMS from client* and select the ZIP file that you have saved previously, and then click .

# Help

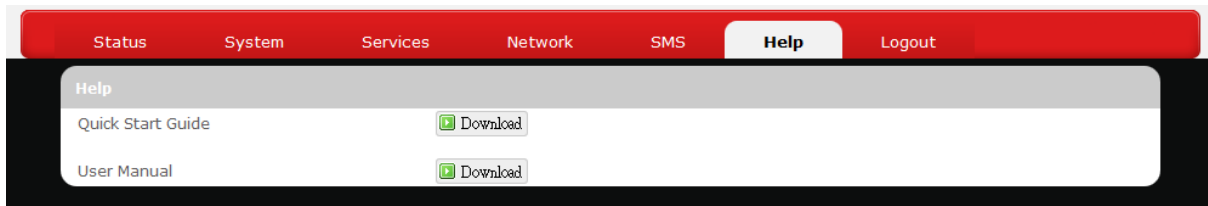

Click the appropriate download link to download the latest Quick Start Guide or User Manual of this product.

# Logout

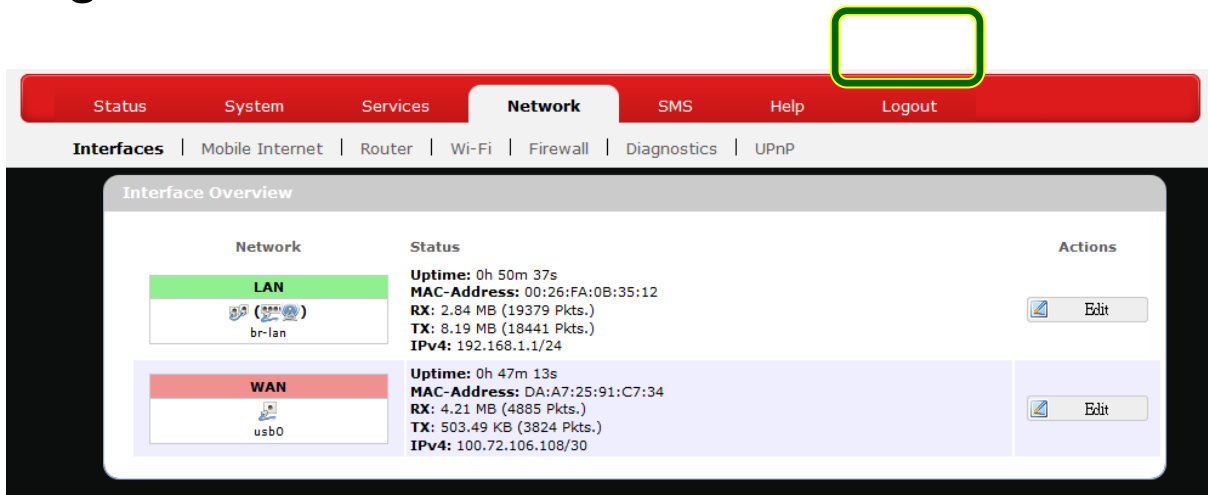

Exits the web configuration interface and re-directs to login prompt.

**Note:** After a period of inactivity, automatic logout will occur. After clicking any menu item, the login prompt will appear as re-login is needed to continue using the web configuration interface.

---

# Appendix A: FAQ

Q: What should I know and how long does it take when I upgrade the firmware of router or modem?

- A:
1. While upgrading the firmware requires some time to finish. During that, you **MUST NOT** turn off the power or interrupt the progress.
  2. You may use an Ethernet cable or a wireless connection to upgrade the firmware. We **suggest the use of an Ethernet cable**.
  3. It may take **2 minutes to upgrade the firmware of the router** and **5 minutes to upgrade the firmware of the modem**.
  4. When the firmware of the modem is upgrading, the UMTS LED will flash among **Blue-Green-Red**. You should wait until the LED is in single color (about 4-5 minutes).

Q: How do I connect to the router?

- A:
1. Connect an Ethernet cable between PC/Notebook (NB) and the router.
  2. Use WiFi to connect.

Q: What's the default "User name" and "Password" for the router?

- A: User name: admin  
Password: admin

Q: How do I enter GUI and setup the configuration for the router?

- A:
1. Connect PC/NB to the router.
  2. Open Internet Explorer or other Web browser.
  3. Input "http://192.168.1.1".
  4. Input User name and Password.

Q: Why can't I connect to the network via built-in 3G module?

- A:
1. Check the SIM/USIM to see if it is inserted well.
  2. Check the UMTS LED on the router to see if it is solid.
  3. Check the Status on GUI to see if the SIM/USIM detected well.
  4. Check the Status on GUI to see if the APN it is correct.
  5. Check the Internet on GUI to see if the Connection is "Keep Alive" or not.

Q: Why can't I link on the GUI?

A: If you have changed your WiFi security, SSID, Local IP address, you have to repair your network to get a new IP that you can link the GUI.

**XP:**

If you are a WiFi user, click **Network Connections** and right click on **Wireless Network Connection**, click **Repair**.

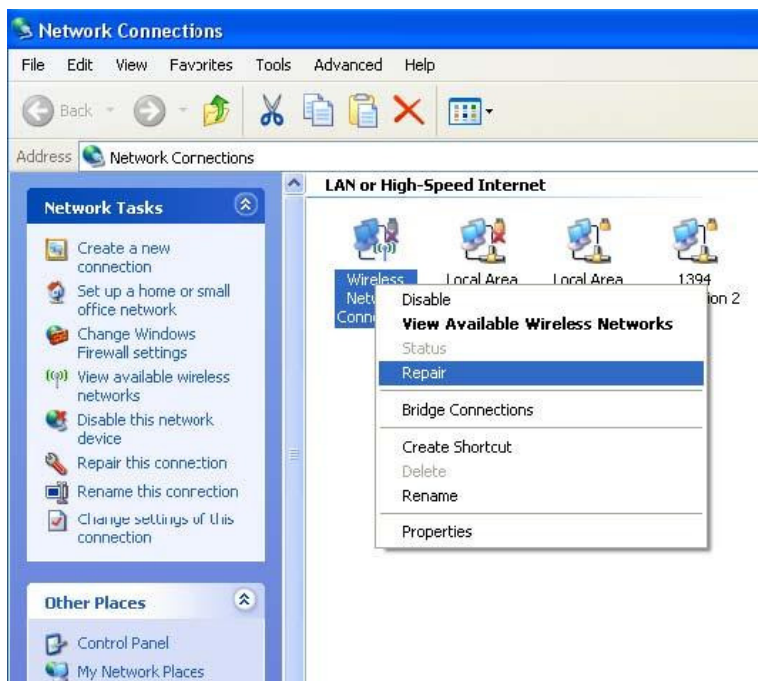

If you use Local Area Connection to connect the Router, click **Network Connections** and right click on **Local Area Connection**, click **Repair**.

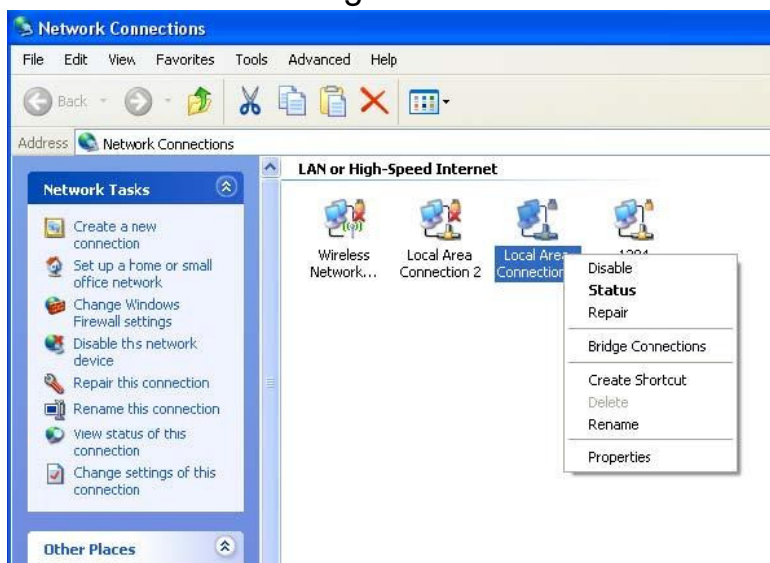

**Vista/7:**

1. If you are a WiFi user, please click **Network and Sharing Center > Manage network connections > Wireless Network Connection > Diagnose**.

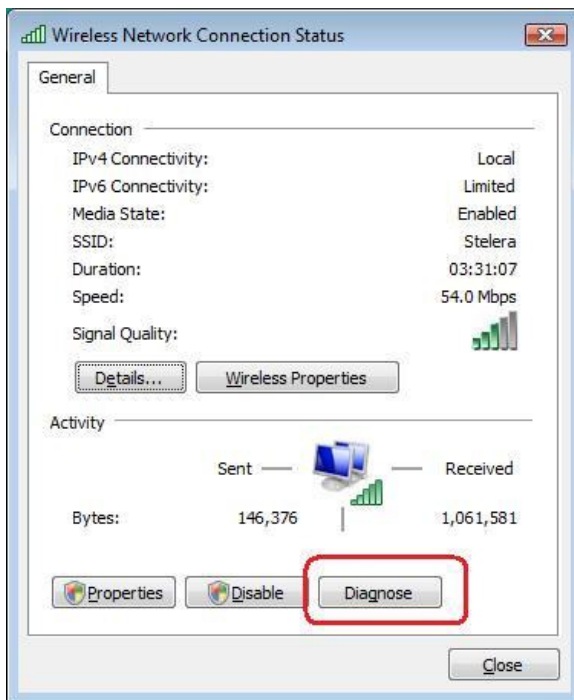

2. Please click **Reset the network adapter “Wireless Network Connection”** and it will began to repair.



3. If you use Local Area Connection to connect the Router, please click **Network and Sharing Center > Manage network connections > Local Area Connection > Diagnose**, follow step 1 and the subsequent messages to repair it.

Q: How do I configure my WiFi settings from GUI?

A: Click the menu tabs **Network → Wi-Fi** to access to the [Wi-Fi](#) submenu, and then click the submenu tab of a particular ESSID.

If you want to configure WiFi Security please click the [“Wireless Security”](#) tab under “Interface Configuration”.

There are seven wireless security encryption options supported by the Router: **WEP Open System**, **WEP Shared Key**, **WPA-PSK**, **WPA2-PSK**, **WPA-PSK/WPA2-PSK Mixed Mode**, **WPA-EAP**, and **WPA2-EAP**.

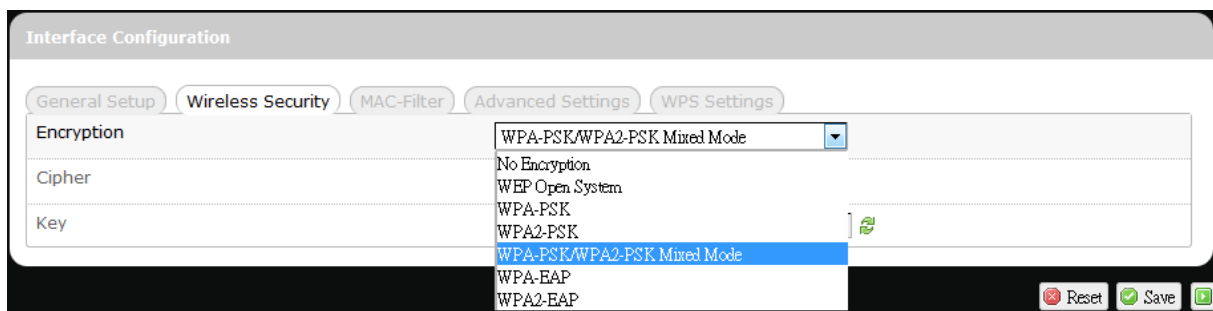

Q: How can I have a long-time link?

A: Click the menu tabs **Network** → **Router** → **Router Setting**. Under “DHCP Service”, set Client Lease Time to a large value (e.g. 120h = 120 hours = 5 days).

Q: Why can't I use the router in the office?

A: Your router's IP address might conflict with the office default settings.

Q: Why is my internet speed is so slow with the router?

A: 1. Click the menu tabs **Status** → **Mobile Internet** to check the Rx Signal Strength in dBm. Weak signals will significantly slow down internet speed.

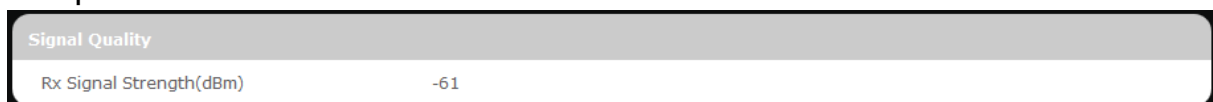

<a href="#">LEDs ON</a>	Signal Strength	3G WCDMA RSSI reading	4G LTE RSRP reading
none	0 bars	Weaker than -100 dBm	Weaker than -115 dBm
#12	1 bar	-100 dBm to (just below) -95 dBm	-115 dBm to (just below) -109 dBm
#12to#13	2 bars	-95 dBm to (just below) -90 dBm	-109 dBm to (just below) -103 dBm



#12to#14	3 bars	-90 dBm to (just below) -83 dBm	-103 dBm to (just below) -95 dBm
#12to#15	4 bars	-83 dBm to (just below) -76 dBm	-95 dBm to (just below) -87 dBm
#12to#16	5 bars	-76 dBm or stronger	-87 dBm or stronger

2. Click the menu tabs **Network** → **Wi-Fi** to access the [Wi-Fi](#) submenu, and then click the submenu tab of the currently used ESSID. Then select a different WiFi Channel under “Device Configuration.”

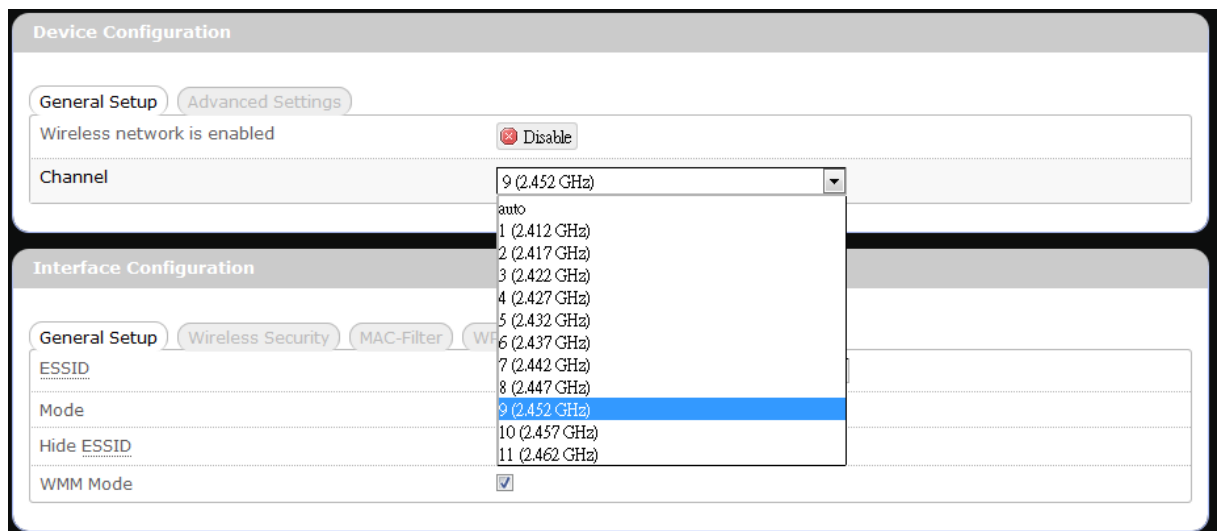

Q: I have connected the computer with the router via LAN connection. Why can't I access the router's IP address "http://192.168.1.1" ?

A: Your computer's IP address and DNS server addresses may have been assigned manually. Please set your computer's IP address and DNS server addresses to be obtained automatically. The Windows setup path is: **Control Panel** → **All Control Panel Items** → **Network and Sharing Center** → **Local Area Connection** → **Properties** → **Internet Protocol Version 4 (TCP/IPv4)**.

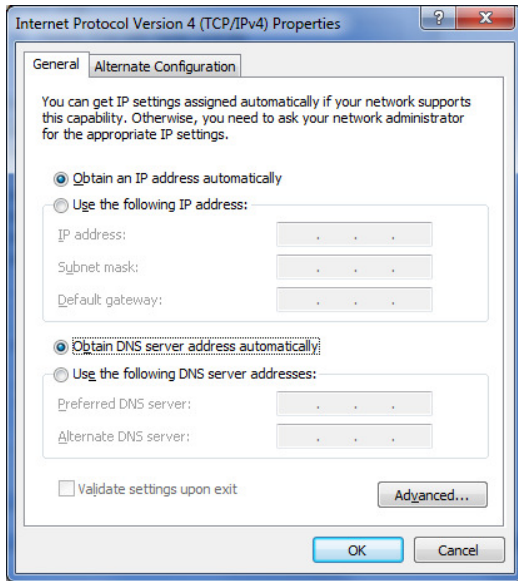

Q: Why can't I use VPN via Router?

A: You may check your office IP settings, the IP settings must not conflict with each other.

Q: How do I configure the settings when I use xDSL to link the router?

- A:
1. PPPoE: Go to the GUI **Internet > Basic Setting > Ethernet Setting**. Change Connection Type to PPPoE. Enter the Username and Password provided by your ISP. Remember to connect your xDSL or Modem to the WAN Port on your Router.
  2. Static IP: Go to the GUI **Internet > Basic Setting > Ethernet Setting**. Change Connection Type to Static IP. Enter the information in the blank provided by your ISP. Remember to connect your xDSL or Modem to the WAN Port on your Router.

Q: Can I prevent others from using my router?

- A: Yes, there are some ways to prevent others from using your router.
1. Enable your WiFi client filter.
  2. Disabled your SSID Broadcast.
  3. Setting your WiFi security.

Q: My PIN code is enabled and where can I input the PIN code to use my Router?

A: Click the menu tabs **Network** → **Mobile Internet** → **U/SIM PIN**

**Management**; enter your PIN Code and click .

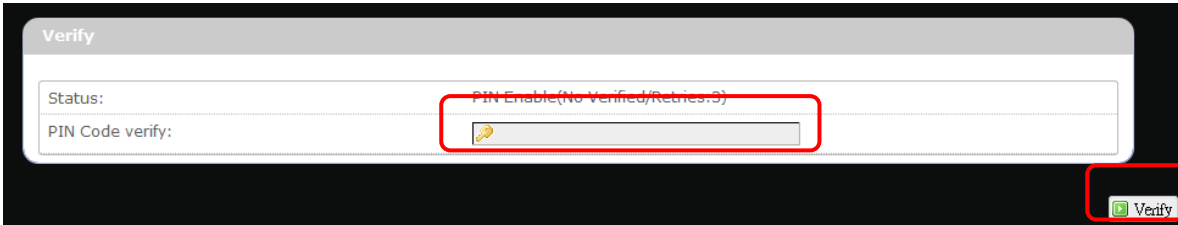

Q: Why does my U/SIM status display “PIN Disable”?

A: Check that the SIM card (which is properly activated by your mobile internet service provider) is inserted correctly in your router.

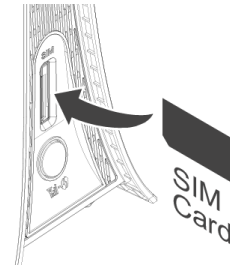

Q: Where can I change the password of the router?

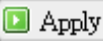
A: Click the menu tabs **System** → **Administration**. Enter the new password twice (set and confirm) and click .

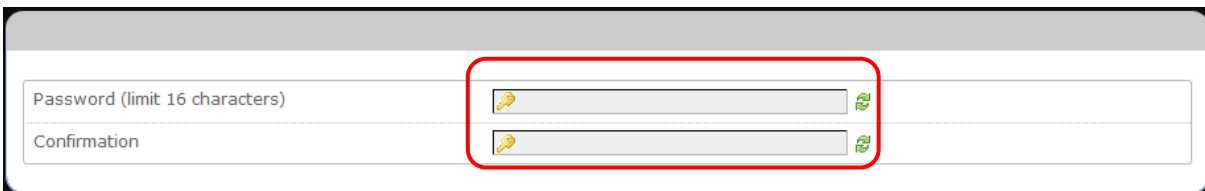

Q: Can I backup and restore all my settings of the router?

A: Yes. Click the menu tabs **System** → **Backup / Flash Firmware** and click

, then follow instructions on the screen to save router settings as a TAR file at a desired location on your computer or mobile device.

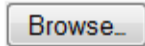
Conversely, to restore previously saved router settings, click  (of “Restore backup”); follow screen instructions to choose the previously

saved TAR file; and then click  .

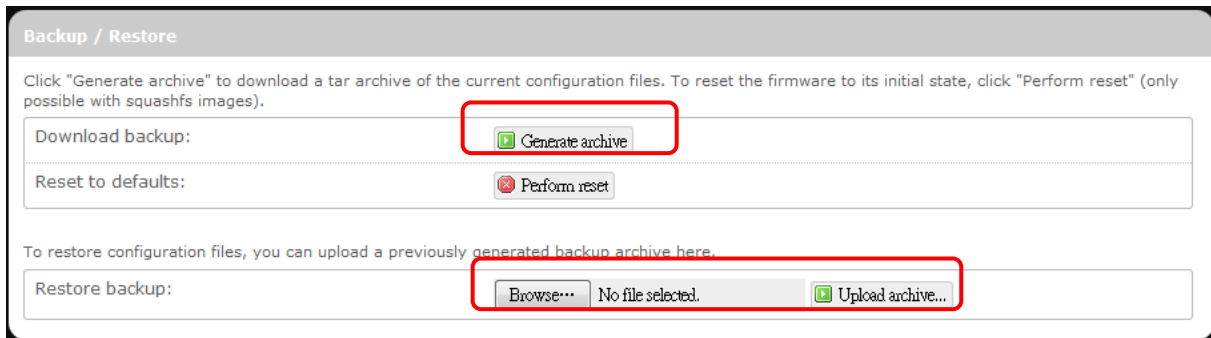

Q: How do I use the **Reset** button on the router?

- A:
1. Short press the Reset button to restart the router.
  2. Long press the Reset for more than 10 sec to reset the router to factory default settings.

Q: Where can I reset the router to factory default settings?

- A:
1. Long press the **Reset** button on the router for more than 10 sec.
  2. Click the menu tabs **System** → **Backup / Flash Firmware** and click



Q: If I remove the SIM when 3G is connected, why can't I see the SIM status change?

A: You have to restart the router to see the status. It is best to remove the SIM card when the router is OFF.

---

# Appendix B: Specifications

**Note: Specifications are subject to change without notice.**

<b>Physical</b>	
WLAN	802.11 b/g/n (2x2 MIMO)
Cellular modem	Embedded, LTE FDD/DC-HSPA+/HSPA+/HSPA/WCDMA
Dimensions (LxWxH, mm)	143.6 x 73.3 x 143
Weight (g)	190
<b>Interface</b>	
Power On/Off Switch	Yes
RJ45 Ports	Four LAN ports, each with LED indicator.
Power supply plug	Yes
SIM slot	Yes
LED Display	Yes, for Network Status, WPS, WiFi, Signal Strength and Power.
SS/WPS/Reset button	Short press for signal strength indication Long press (>3s, <10s) for WPS activation Long press (>10s) for reset to factory default setting
<b>Connectivity and Data Speed</b>	
4G LTE Band	Band 2, Band 4
LTE Data Rate	Downlink: up to 100Mbps, Uplink: up to 50Mbps
LTE Bandwidth	Up to 20 MHz
3G WCDMA Band	Band 2, Band 5, Band 8

WLAN	802.11 b/g/n, 2x2 MIMO
<b>Antenna</b>	
Cellular embedded main antenna	Yes
Cellular embedded diversity antenna	Yes, supporting LTE bands
Cellular external main antenna port	Yes
Cellular external diversity antenna port	Yes
WiFi antenna	Embedded
<b>Router Features</b>	
Routing	Static Routing, Dynamic Routing (RIP)
Security	Multiple VPN pass-through (IPSec, PPTP, L2TP), Internet Access Policy (Parental control), Stateless and SPI Firewall
NAT-NAPT	Single Port Forwarding, Port Range Forwarding, Port Range Triggering, Port Filtering, DMZ, UPnP, Multicast Pass-Through
DNS	DNS Agent, DDNS
Other features	IPv4, IPv6, IPv4v6 dual stack, TCP, UDP, ICMP, ARP, DHCP Server/Client, HTTP/HTTPS, NTP, ALGs (FTP, PPTP, RTSP)
Browser-based Administration GUI	Setup Wizard in GUI. Browser supported: IE, Firefox, Safari, Chrome
<b>Wireless LAN</b>	

802.11b data rate	1/2/5.5/11 Mbps
802.11g data rate	Up to 54 Mbps
802.11n data rate	Up to 300 Mbps
802.11e QoS	WMM (WiFi Multimedia), No ACK
Security Types	WPA2/WPA/AES/TKIP, WPA/WPA2 PSK mode, None/64/128 bits WEP Encryption, open system authentication.
Device Unique Default Encryption Key	Such unique key is linked to MAC address of the device.
Auto Channel Select (ACS)	Yes, for channel 1 through 11
Other features	WPS software button, SSID broadcast disable, Guest Network (Dual SSID), Access control (MAC filter), WLAN on/off software switch.

### Status Indication

LED Display	<ul style="list-style-type: none"> <li>1x 3-color Network Status</li> <li>1x Power (also multiplexed with signal strength)</li> <li>1x WiFi (also multiplexed with signal strength)</li> <li>1x WPS (also multiplexed with signal strength)</li> <li>1x SMS (also multiplexed with signal strength)</li> <li>1x Signal Strength without multiplex</li> </ul>
-------------	--

### Software Features

Web GUI	<p>Web-based Setup Wizard in GUI.</p> <p>Browser supported: IE, Firefox, Safari</p>
Web GUI Language	English

Support	
Connection Status in Web GUI	Network name, Signal strength, Roaming indication, Radio technology, Connection status, Connection time, Total downlink/uplink byte
Connection management	Connection on demand, Connection when available, Auto APN matching with USIM , APN database update through browser-based GUI, PIN management, Preferred radio NW type selection, Auto/Manual network selection.
System protection	Password protected system reset to factory default, Password protected administrator and user access authority (provisioning, configuration, authentication).
Support FW version upgrade	Yes
Device Management	TR-069
<b>Accessories</b>	
Power Adapter	Input: 100to240V, 50to60Hz AC; Output: 9V DC

<b>Environment</b>	
Operation Temperature	0°C to 45°C (32°F to 113°F)
Storage Temperature	-20°C to 60°C (-4°F to 140°F)
Operating Humidity	10% to 80% Non-Condensing
Storage Humidity	5% to 90% Non-Condensing



---

## Certification

	RoHS
--	------

---

# ***Appendix C: Important Safety Information and Glossary***

## **Europe – EU Declaration of Conformity**



### **European Union Notice**

Products with CE marking comply with the R&TTE Directive (99/5/EC), the EMC Directive (2004/108/EC), and the Low Voltage Directive (2006/95/EC) issued by the Commission of the European Community.

Compliance with these directives implies conformity to the following European Norms (in parentheses are the equivalent international standards).

### **EN 60950-1 (IEC 60950-1)**

Safety of Information Technology Equipment.

### **EN 300 328**

Electromagnetic compatibility and Radio spectrum Matters (ERM); Wideband Transmission systems; data transmission equipment operating in the 2.4 GHz ISM band and using spread spectrum modulation techniques.

### **EN 301 489-24**

Electromagnetic compatibility and Radio spectrum Matters (ERM);  
Electromagnetic Compatibility (EMC) standard for radio equipment and services;  
Part 24: Specific conditions for IMT-2000 CDMA direct spread (UTRA) for mobile and portable (UE) radio and ancillary equipment.

### **ETSI EN 301 511**

Global system for mobile communications (GSM); Harmonised EN for mobile stations in the GSM 900 and GSM 1800 bands, covering essential requirements of article 3.2 of the R&TTE

---

directive (1995/5/EC).

**ETSI EN 301 489-1**

Electromagnetic compatibility and Radio spectrum Matters (ERM);  
Electromagnetic Compatibility (EMC) standard for radio equipment and services; Part 1: Common technical requirements.

**ETSI EN 301 489-7**

Electromagnetic compatibility and Radio spectrum Matters (ERM);  
Electromagnetic Compatibility (EMC) standard for radio equipment and services;  
Part 7: Specific conditions for mobile and portable radio and ancillary equipment of digital cellular radio telecommunications systems (GSM and DCS).

**ETSI EN 301 489-17**

Electromagnetic compatibility and Radio spectrum Matters (ERM);  
Electromagnetic Compatibility (EMC) standard for radio equipment and services;  
Part 17: Specific conditions for 2.4 GHz wideband transmission systems.

**ETSI EN 301 908-1 & -2**

Electromagnetic compatibility and Radio spectrum Matters (ERM); Base Stations (BS), Repeaters and User Equipment (UE) for IMT-2000 Third Generation cellular networks; Part 1: Harmonised EN for IMT-2000, introduction and common requirements, covering essential requirements of article 3.2 of the R&TTE Directive.

**EN 50385**

Product standard to demonstrate the compliance of radio base stations and fixed terminal stations for wireless telecommunication systems with the basic restrictions or the reference levels related to human exposure to radio frequency electromagnetic fields (110 MHz - 40 GHz) - General public.

---

# Federal Communication Commission Interference Statement

15.21

You are cautioned that changes or modifications not expressly approved by the part responsible for compliance could void the user's authority to operate the equipment.

15.105(b)

## Federal Communications Commission (FCC) Statement

This equipment has been tested and found to comply with the limits for a Class B digital device, pursuant to part 15 of the FCC rules. These limits are designed to provide reasonable protection against harmful interference in a residential installation. This equipment generates, uses and can radiate radio frequency energy and, if not installed and used in accordance with the instructions, may cause harmful interference to radio communications. However, there is no guarantee that interference will not occur in a particular installation. If this equipment does cause harmful interference to radio or television reception, which can be determined by turning the equipment off and on, the user is encouraged to try to correct the interference by one or more of the following measures:

- Reorient or relocate the receiving antenna.
- Increase the separation between the equipment and receiver.
- Connect the equipment into an outlet on a circuit different from that to which the receiver is connected.
- Consult the dealer or an experienced radio/TV technician for help.

### **This device complies with Part 15 of the FCC Rules. Operation is subject to the following two conditions:**

- 1) This device may not cause harmful interference and
- 2) This device must accept any interference received, including interference that may cause undesired operation of the device.

### **FCC RF Radiation Exposure Statement:**

This equipment complies with radio frequency (RF) exposure limits adopted by the

---

Federal Communications Commission for an uncontrolled environment. This equipment should operate with minimum distance 20 cm between the radiator & your body.



---

## Glossary

**2G:** Second-generation mobile networking technology. Represents a switchover from analog to digital; most 2G networks use GSM.

**3G:** Third-generation mobile networking technology that enables simultaneous transfer of voice and non-voice data; most 3G networks use WCDMA.

**3.5G:** A more recent standard of mobile networking technology; generally uses HSDPA.

**3.75G:** A more recent standard of mobile networking technology; generally uses HSUPA.

**4G:** A more recent standard of mobile networking technology; generally uses LTE.

**APN (Access Point Name/Network):** Provides GPRS routing information. Consists of:

Network ID: Identifies the external service requested by a GPRS user.

Mobile network operator ID: Specifies routing information.

**ARFCN (Absolute Radio Frequency Channel Number):** The specific ID numbers for all radio channels used in cellular mobile communications.

**bps (bits per second):** How data flow is measured.

**CHAP (Challenge Handshake Authentication Protocol):** CHAP identifiers are changed frequently and authentication can be requested by the server at any time.

**DNS (Domain Name System):** Helps route network traffic by making the addressing process more user-friendly.

**DHCP (Dynamic Host Configuration Protocol):** How devices obtain IP addresses from a server.

**DUN (Dial-Up Network):** Windows component that enables online access via a modem.

**EDGE (Enhanced Data GSM Environment/Enhanced Data for Global Evolution):**

Advanced GPRS that delivers multimedia and other data needing greater bandwidth at up to 237 kbps.

**GPRS (General Packet Radio Service):** Delivers data in packets at up to 86 kbps.

**GSM (Global System for Mobile Communications):** The most popular cellular network, mostly operates in 850-900 or 1800-1900 MHz; the primary 2G system.

**HSDPA (High Speed Downlink Packet Access):** Advanced WCDMA that delivers downlink

---

bandwidth intensive data at up to 7.2Mbps; typically associated with 3.5G.

**HSUPA (High Speed Uplink Packet Access):** Advanced WCDMA that delivers uplink bandwidth intensive data at up to 5.76Mbps; typically associated with 3.75G.

**HSPA+ (High Speed Packet Access +):** This is also known as HSPA Evolved, is the next step and is more focused on delivering data services enabling speeds of up to 42Mbps in the downlink and 11Mbps in the uplink.

**IMEI (International Mobile Equipment Identity):** A number unique to each GSM/UMTS device that can be used block network access by a stolen mobile device.

**IP (Internet Protocol):** Routes packets over a network.

**Kbps (Kilobits per second):** A data flow measure; 1024 bits/second.

**LAN (Local Area Network):** A data network with limited range but good bandwidth.

**Mbps (Megabits per second):** A data flow measure; 1,048,576 bits/second.

**LTE (Long Term Evolution):** High-speed mobile communication standard based on the GSM/EDGE and UMTS/HSPA network technologies. LTE provides downlink peak rates up to 300 Mbit/s and uplink peak rates up to 75 Mbit/s.

**PAP (Password Authentication Protocol):** The difference between PAP authentication and a manual or scripted login, is that PAP is not interactive. The username and password are entered in the client's dialing software and sent as one data package as soon as the modems have established a connection, rather than the server sending a login prompt and waiting for a response.

**PPP (Point-to-Point Protocol):** An internet connection method.

**PIN (Personal Identity Number):** Four to eight digital numbers SIM card security code; allows access to the carrier's network.

**Rx:** Shorthand for Reception.

**SIM (Subscriber Identity Module):** A small card that contains key mobile device identification, subscription and contact information.

**Tx:** Shorthand for Transmission.

**WCDMA (Wideband Code Division Multiple Access):** Advanced EDGE that supports 384kbps data flow. Most 3G networks use this standard, the same as UMTS.