

JukeBlox Networked Media Module CR Series Datasheet



Complete audio networking system on a small module

Integrated Ethernet + USB2.0

WiFi-certified 802.11b/g

Built-in PIFA antenna

Glueless audio, video and control ports

FCC certified

Ideal for enabling network and USB audio playback for iPod docks, audio systems, AV Receivers, active speaker systems, internet radios, network playback adaptors

CONFIDENTIAL

Table of Contents

1. Introduction	4
2. Block Diagram	4
3. Board Pictures	5
3.1 Top View of CR870-2A	5
3.2 Bottom View of CR870 types 2A, 2D & 2S	5
3.3 Top View of CR870 types 2C, 2F, 2G, 2I, 2J, 2K & 2R	6
3.4 Bottom View of CR870 types 2C, 2G, 2I, 2J, 2K, 2L, 2N, 2O, 2P & 2R	6
3.5 Top View of CR870 types 2D, 2L, 2N, 2O, 2P, 2Q & 2S	7
4. Ordering Guide	8
5. Electrical Specifications	9
5.1 Absolute Maximum Ratings	9
5.2 Operating Conditions	10
5.3 WiFi Specification (CR870 only)	10
6. Regulatory Compliance and Quality	11
6.1 RoHS	12
6.2 Environmental Test	12
6.3 ESD and Transient Test (Applies to LAN and USB external connections only)	12
6.4 Magnetic Field Test	12
6.5 MTBF	12
6.6 Mechanical Specifications	12

6.7 Module Quality	12
7. Board Dimensions and Weight	13
7.1 Top View and Side View of CR870 modules with PIFA antenna & no shields	13
7.2 Bottom View of CR870 modules with no bottom shield	13
7.3 Top View and Side View of CR870 modules without PIFA antenna	14
7.4 Top View and Side View of CR870 modules with PIFA antenna & top shield	14
7.5 Module weight	15
8. Connectors and Connections	15
8.1 WLAN UFL Antenna Connector (optional)	15
8.1.1 Coaxial antenna connector dimensions	15
8.2 Module Connectors	15
8.2.1 Pin Descriptions	16
8.2.2 Connector PIN Assignments	20
9. Application Guidelines	21
9.1 Power Supply sequencing and Reset Timing	21
9.1.1 Power up, Reset and Power Down Timing	22
9.2 RF Considerations	22
10. Revision Control	23
Module Revision History	26
Trademarks	26
Warranty Limitations	26

1. Introduction

The CR-series module is a single-board networked media player module, based on BridgeCo's DM860 and DM870 media processors, and enables fast product developments with Ethernet, USB and optional WiFi connectivity. The module connects to standard legacy components in various audio, video/LCD and control formats.

2. Block Diagram

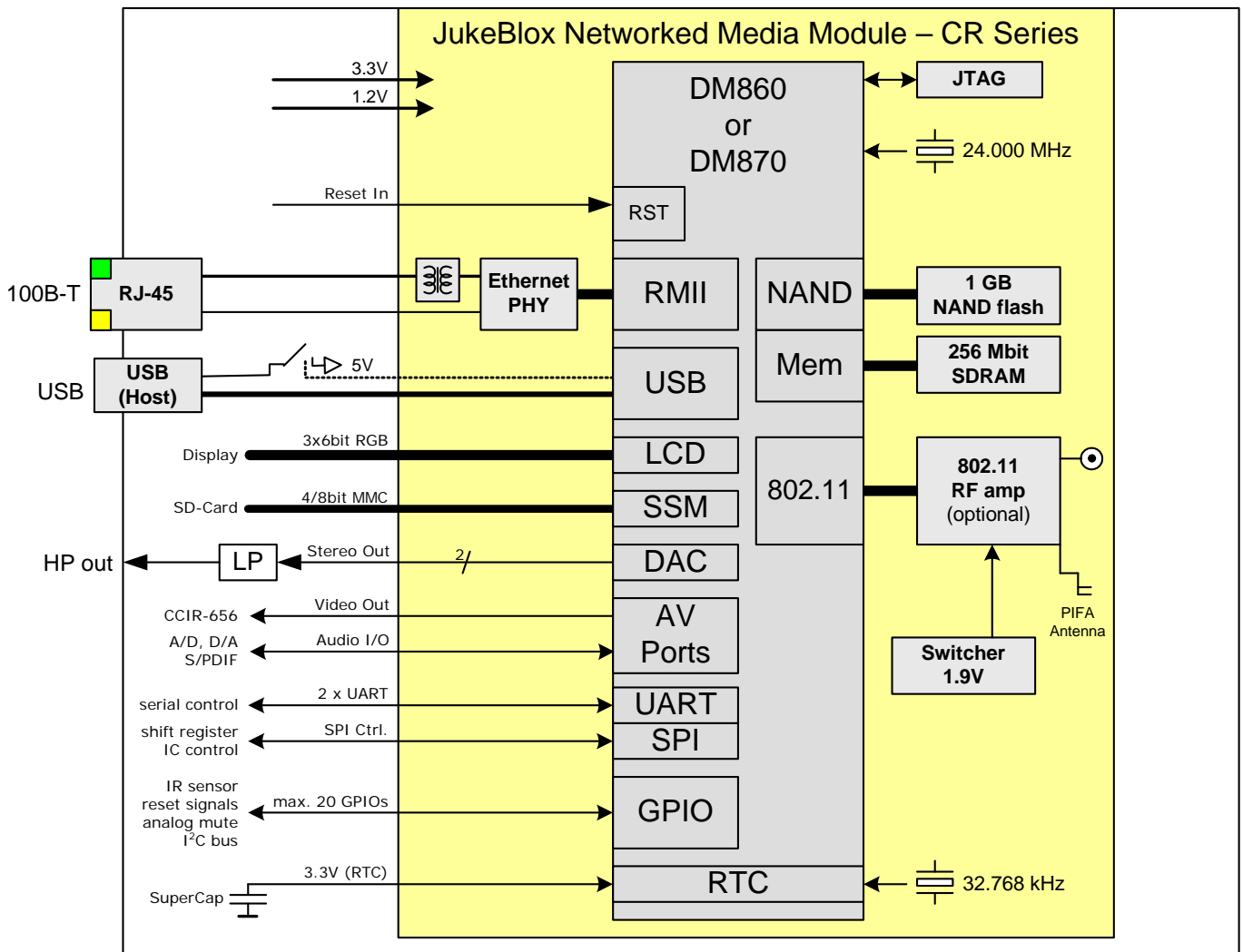

3. Board Pictures

3.1 Top View of CR870-2A

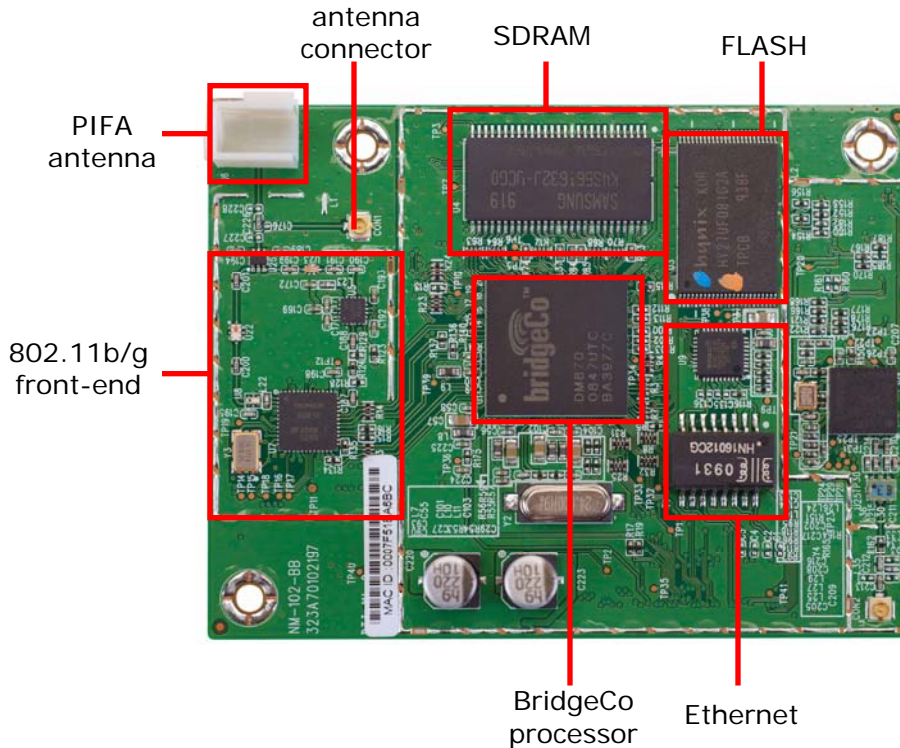

Note: Components and Socket to the right of the Ethernet and Flash sections are not installed in production modules. Please see Section 3.3 for example production module top view picture.

3.2 Bottom View of CR870 types 2A, 2D & 2S

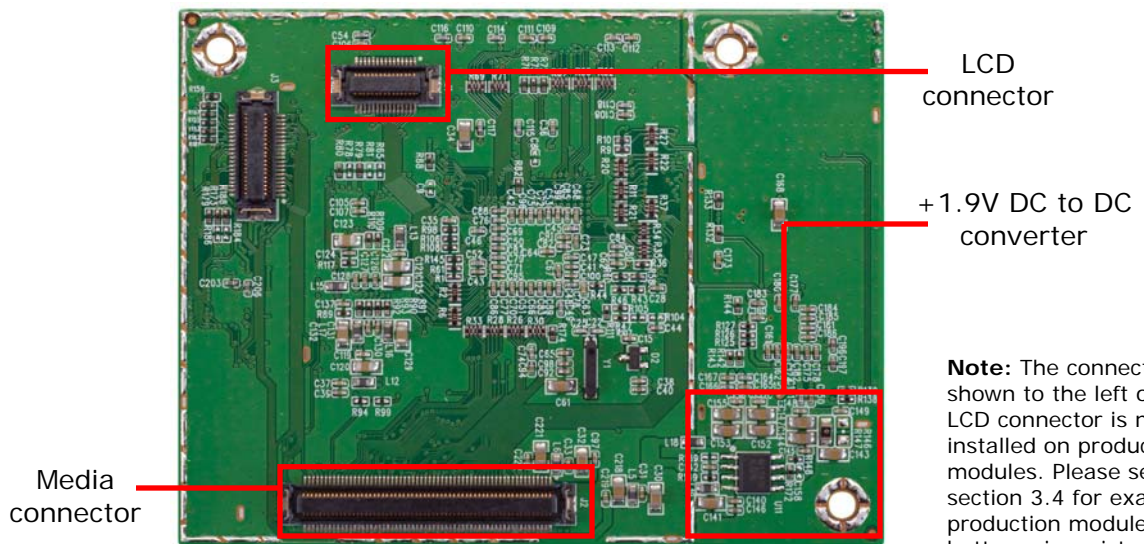

Note: The connector shown to the left of the LCD connector is not installed on production modules. Please see section 3.4 for example production module bottom view picture.

3.3 Top View of CR870 types 2C, 2F, 2G, 2I, 2J, 2K & 2R

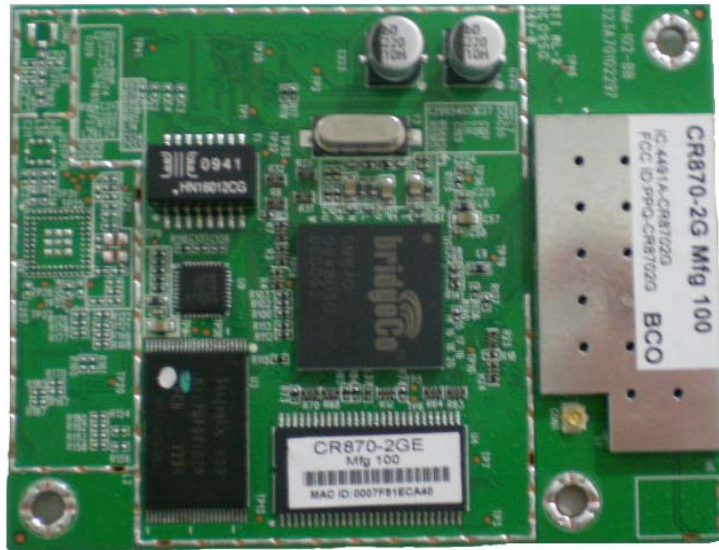

Version with no top shield.

Please note that label text will change to show version, and versions 2I, 2J, 2K will have no Ethernet components mounted.

3.4 Bottom View of CR870 types 2C, 2G, 2I, 2J, 2K, 2L, 2N, 2O, 2P & 2R

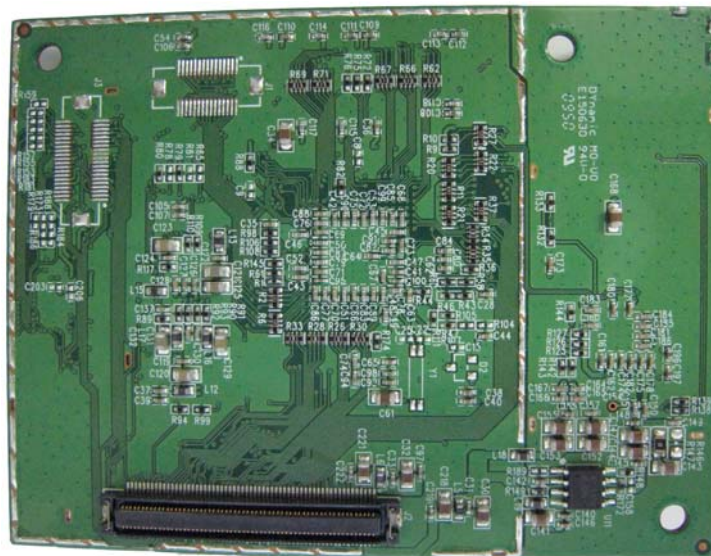

Versions with no bottom shield and no LCD connector.

Please note that production version does not have exposed solder on the underside of the mounting holes.

3.5 Top View of CR870 types 2D, 2L, 2N, 2O, 2P, 2Q & 2S

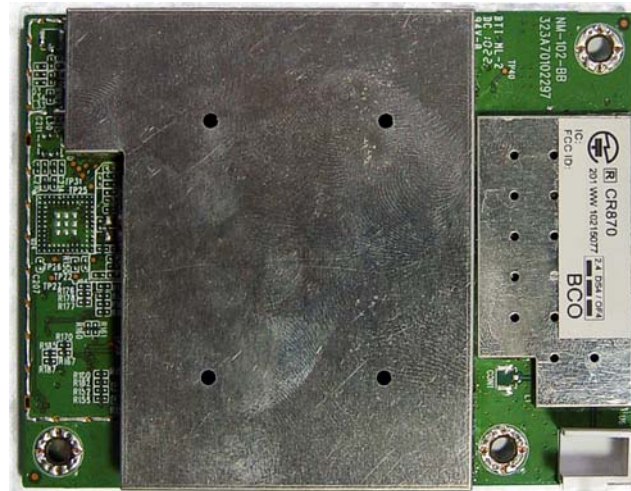

Versions with top shield.

For versions without PIFA antenna, PIFA antenna is not present and UFL connector is present, see the top view of CR870-2A for location of UFL connector.

4. Ordering Guide

Part Number	BridgeCo ICs	WiFi	Ethernet	USB	Real-Time Clock	LCD	PIFA Antenna	Ext. Antenna UFL Conn.	SDRAM	Top Module Shielding
		Contains shield				Incl. connector				
CR870-2A	DM870+T6201	X	X	X	X	X	X	(X)*	32MB	
CR870-2C	DM870+T6201	X	X	X			X		32MB	
CR870-2D	DM870+T6201	X	X	X		X	X		32MB	X
CR870-2F	DM870+T6201	X	X	X	X	X	X	(X)*	32MB	
CR870-2G	DM870+T6201	X	X	X				X	32MB	
CR870-2I	DM870+T6201	X		X				X	16MB	
CR870-2J	DM870+T6201	X	X	X			X		16MB	
CR870-2K	DM870+T6201	X	X	X				X	16MB	
CR870-2L	DM870+T6201	X	X	X				X	32MB	X
CR870-2M	DM870+T6201	X	X	X	X	X	X	(X)*	32MB	X
CR870-2N	DM870+T6201	X		X				X	16MB	X
CR870-2O	DM870+T6201	X	X	X				X	16MB	X
CR870-2P	DM870+T6201	X	X	X			X		32MB	X
CR870-2Q	DM870+T6201	X	X	X				X	32MB	X
CR870-2R	DM870+T6201	X	X	X				X	16MB	
CR870-2S	DM870+T6201	X	X	X		X		X	32MB	X
CR860-2A	DM860	n/a	X	X			n/a	n/a	32MB	
CR860-2B	DM860	n/a	X	X	X	X	n/a	n/a	32MB	

* Connector on board, but not enabled

Note: Shaded rows are Custom or Obsolete configurations – not to be used for new / standard MP designs.

5. Electrical Specifications

Parameter	State	Model	Voltage	Symbol	min.	typ.	max.	Units
Power Supply Voltage				V _{IN}	+2.97 +1.08	+3.3 +1.2	+3.63 +1.32	V
Logic Input high voltage				V _{IH}	1.7		5.5	V
Logic Input low voltage				V _{IL}	-0.3		0.7	V
Logic Input threshold voltage				V _{IT}	1.29	1.39	1.5	V
Schmitt-trigger input low to high threshold voltage				V _{IT+}	1.58	1.65	1.71	V
Schmitt-trigger input high to low threshold voltage				V _{IT-}	0.95	1.01	1.06	V
Logic Output high voltage				V _{OH}	2.4			V
Logic Output low voltage				V _{OL}			0.4	V
Logic Low-level output current (V _{OL} =0.4V)				I _{OL}	-9.6	-15.6	-19.3	mA
Logic High-level output current (V _{OH} =2.4V)				I _{OH}	11.1	22.5	35.3	mA
Power Consumption	Reset State	CR870 int 1.9V	3.3V	PIN3.3	-	230	300	mW
			1.2V	PIN1.2	-	45	60	mW
		CR870 ext 1.9V	3.3V	PIN3.3	-	165	215	mW
			1.2V	PIN1.2	-	45	60	mW
			1.9V	PIN1.9	-	35	50	mW
		CR860	3.3V	PIN3.3	-	145	190	mW
	1.2V		PIN1.2	-	45	60	mW	
	WLAN Operating	CR870 int 1.9V	3.3V	PIN3.3	-	1750	2275	mW
			1.2V	PIN1.2	-	600	800	mW
		CR870 ext 1.9V	3.3V	PIN3.3	-	825	1075	mW
			1.2V	PIN1.2	-	600	800	mW
			1.9V	PIN1.9	-	535	700	mW
			CR860	3.3V	PIN3.3	-	760	990
	1.2V	PIN1.2		-	600	800	mW	

Note: The maximum power consumption values are 30% larger than the typical values. The maximum values are intended to be used for power supply sizing calculations.

5.1 Absolute Maximum Ratings

Parameter	Component	Min	Max	Units
3.3V Supply Voltage	Main	-0.5	4.6	V
1.2V Supply Voltage		-0.5	1.8	V
Logic Input Voltage		-0.5	6	V
Logic Output Voltage		-0.5	4.6	V

5.2 Operating Conditions

Parameter	Min	Max	Units
Operating Temperature	0	+70	°C
Operating Humidity	10	90 (non condensing)	%RH
Storage Temperature	-10	+75	°C
Storage Humidity	10	95 (non condensing)	%RH
Storage Temperature Cycle Test 24 hrs	-10	+75	°C

5.3 WiFi Specification (CR870 only)

Feature	Description
WLAN Standards	IEEE 802.11b IEEE 802.11g
Frequency Band	2.412 – 2.472 GHz (2.4GHz ISM Band, 13 Channels) Channel 1 - Channel 13 North America, Japan Telec, Europe ETSI
Modulation	802.11b mode (DS-SS: IEEE 802.11b) 802.11g mode (OFDM: IEEE 802.11g)
Transmission Speed	802.11b mode 11Mbps, 5.5Mbps, 1Mbps 802.11g mode 54Mbps, 48Mbps, 36Mbps, 24Mbps, 18Mbps, 12Mbps, 9Mbps, 6Mbps
Tx Power	802.11b mode (16.5dBm, +/-1dBm) 802.11g mode (21dBm, +/-1dBm)
Power-on Ramp	< 2us
RF Carrier Suppression	< 15dBc
TX EVM	< -9dB @ 6Mbps < -25dB @ 54Mbps
Rx Sensitivity (incl. CE2 Mother board)	802.11b mode =<-88dBm @ 1Mbps, =<-85dBm @ 5.5Mbps, =<-83dBm @ 11Mbps 802.11g mode =<-86dBm @ 6Mbps, =<-75dBm @ 36Mbps, =<-69dBm @ 54Mbps
Throughput Rate (measured for each module)	See factory test specification

6. Regulatory Compliance and Quality

Description	Country	Compliance	Module Versions Passed
Electromagnetic Compatibility (Prescan)	USA Europe	FCC CFR47 Part15B EN 55022 EN 55024 EN 61000-3-2 EN 61000-3-3 EN 61000-4-2 EN 61000-4-3 EN 61000-4-4 EN 61000-4-5 EN 61000-4-6 EN 61000-4-8 EN 61000-4-11	
Radio Regulations (CR870 only)	USA Japan Canada Europe New Zealand/Australia China Korea	FCC Part 15C Telec IC RSS-210 CE CE SRRC KCC	C, G, I, J, D C, G, J, D C, G, I, J, D C, G, J

Note: BridgeCo does not certify all module variants for all countries. Please contact your BridgeCo sales office for the latest information about which modules are certified for which countries, and arranging for additional certification for your chosen module if needed. Product manufacturers are responsible for the end product certification.

Several products using CR870 series modules have passed the WiFi Alliance logo certification tests. BridgeCo can help manufacturers to prepare for the WiFi Alliance tests by providing an example test plan and the required commands to enable special test modes. Please contact your BridgeCo sales office about WiFi Alliance logo certification assistance.

6.1 RoHS

Uses only RoHS compliant components

6.2 Environmental Test

Withstands 4 hours at 70°C, 90% RH

6.3 ESD and Transient Test (Applies to LAN and USB external connections only)

ESD: +/- 2kV operation, +/- 4kV no destruction (part of CE test)

Fast electrical transients: +/- 500V operation, +/- 1000V no destruction (part of CE test)

6.4 Magnetic Field Test

Passes EN55022 and EN55024 (part of CE test)

6.5 MTBF

>10000 hours

6.6 Mechanical Specifications

Passes drop test according to I.E.C. 68-2-32, height 100 cm, 1 corner, 6 faces.

Passes vibration test with sine, vertical, 60 minutes, 600 to 18000 cpm, 1G

6.7 Module Quality

Defect Rate: 7 months <0.5% failures, 14 months <1% failures

AQL CR=0, MA=0.4, MI=0.4

7. Board Dimensions and Weight

Note: For mechanical details of versions CR870-2C Mfg200 and CR870-2Q, please see the appropriate addendum: *dat_CR860_CR870_3_3_datasheet_addendum_2C_Mfg200a.pdf* or *dat_CR860_CR870_3_5_datasheet_addendum_2Q.pdf*. These addendums are available upon request from BridgeCo.

7.1 Top View and Side View of CR870 modules with PIFA antenna & no shields

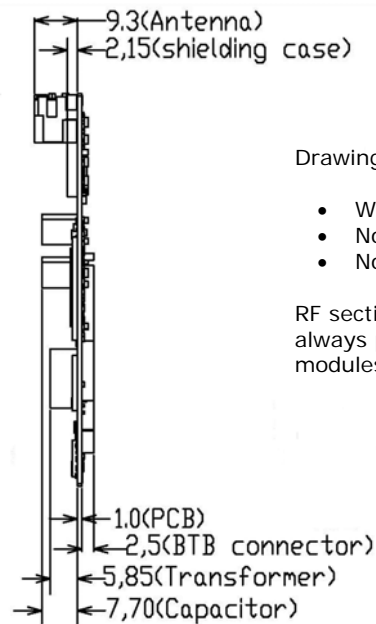
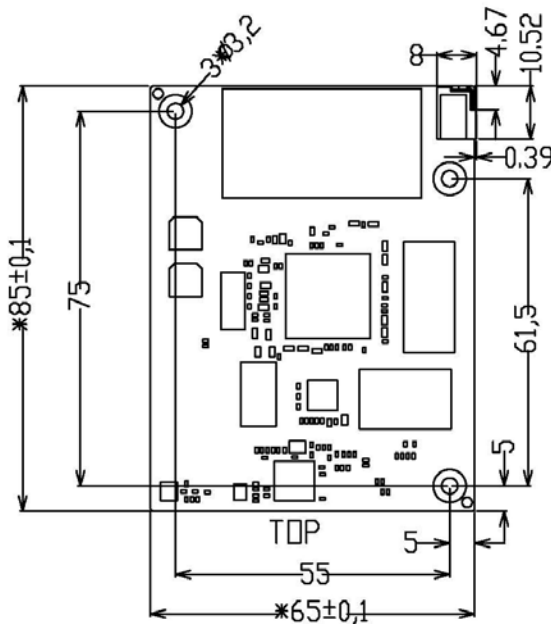

Drawings shown:

- With PIFA antenna
- No top shield
- No bottom shield

RF section shield is always present in CR870 modules.

7.2 Bottom View of CR870 modules with no bottom shield

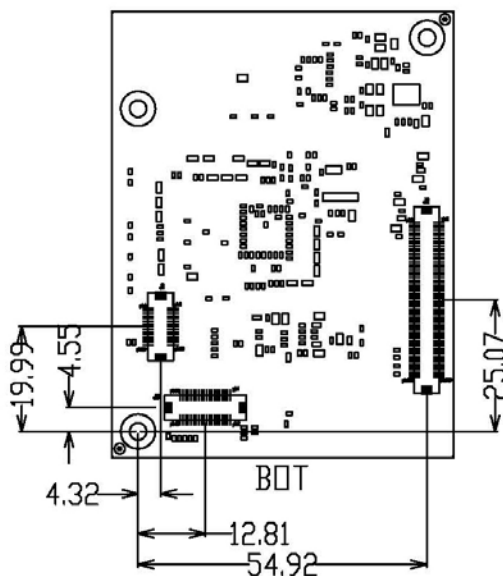

Drawing shown:

- With connector locations
- No bottom shield

Note:

1. All dimensions are measured in **millimetres** (mm).
2. PCB's thickness: 1.00 +/- 0.10mm
3. Tolerance: +/-0.10mm
4. Outline Tolerance: +/-0.10mm
5. NPTH Hole: +/-0.05mm
6. PTH Hole: +/-0.075mm
7. Connector positions, board dimensions, mounting hole positions and sizes are the same for all module variants.
8. Connector position tolerance: +/- 0.38mm

7.3 Top View and Side View of CR870 modules without PIFA antenna

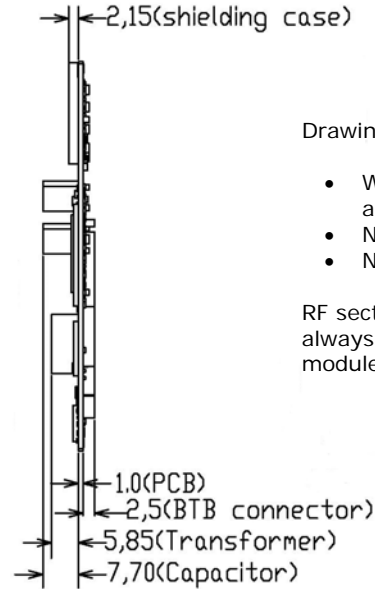
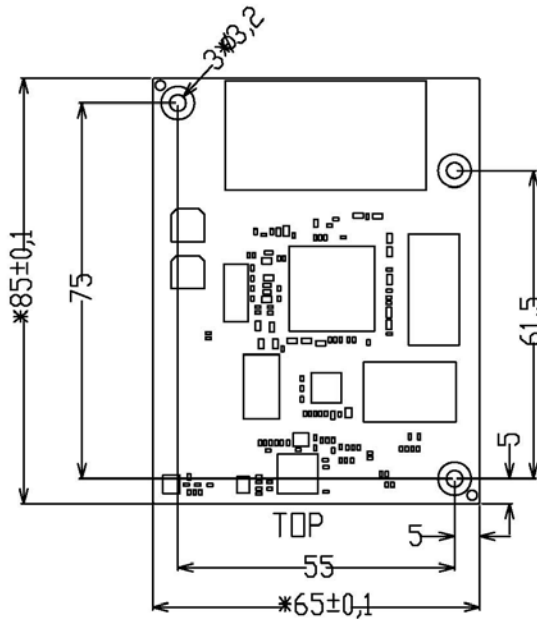

Drawings shown:

- Without PIFA antenna
- No top shield
- No bottom shield

RF section shield is always present in CR870 modules.

7.4 Top View and Side View of CR870 modules with PIFA antenna & top shield

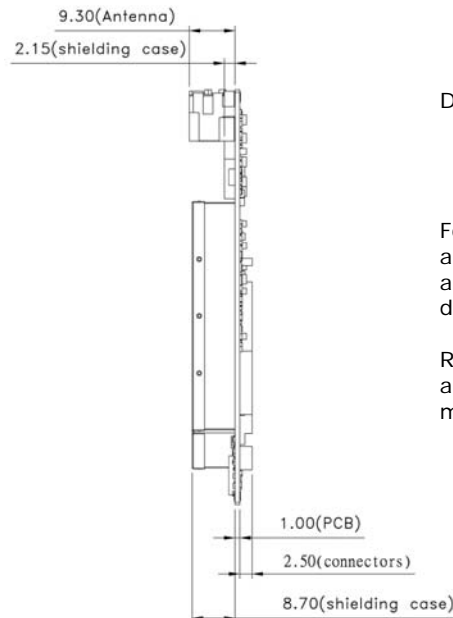
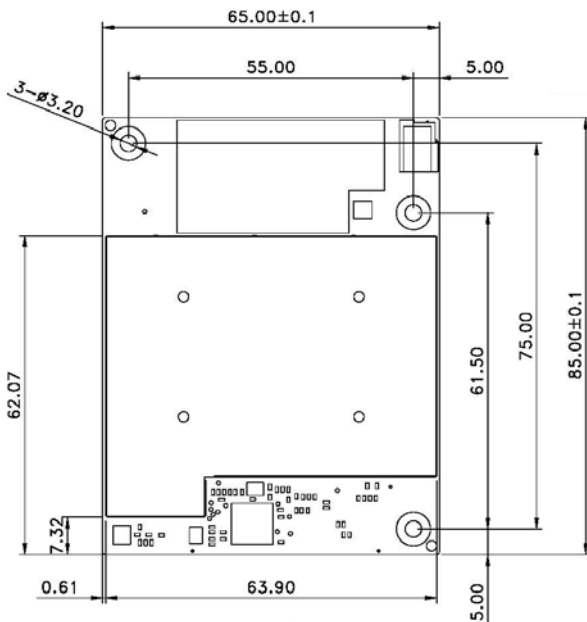

Drawings shown:

- With PIFA Antenna
- With top shield

For versions without PIFA antenna, ignore PIFA antenna shown on the drawings in this section.

RF section top shield is always present in CR870 modules.

7.5 Module weight

CR860: 25g
CR870: 25g

Note: Module weight applies to all versions of the module.

8. Connectors and Connections

8.1 WLAN UFL Antenna Connector (optional)

One coaxial antenna connector is provided as an alternative to the built-in PIFA antenna. The choice between using the PIFA antenna or using the coaxial socket is a build option, determined by the position of a surface mount capacitor on the module PCB. Please see ordering guide for build option details.

The surface-mount receptacle parts:

Hirose
U.FL-R-SMT (CL No. 331-0471-0)

8.1.1 Coaxial antenna connector dimensions

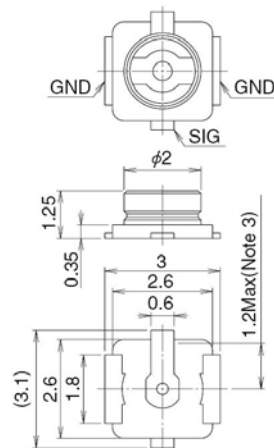

8.2 Module Connectors

The CR860/870 module uses 3 female board-to-board connectors as interfaces to the product main board. The connectors needed on the product main board are male type, with the part numbers as shown in the table below.

Connector Number	Connector Purpose	Connector Type	Number of Pins	Pin Configuration	Male Mating Connector Part Numbers
J1	LCD	B2B Connector	30	2 x 15 x 0.5mm	14-5046-030-145-829+ (Kyocera)
J2	Media		120	2 x 60 x 0.5mm	14-5046-120-145-829+ (Kyocera)

8.2.1 Pin Descriptions

Signal(s)	Type	Description
-----------	------	-------------

POWER

VIN(+3.3V)	P	Power supply input ; +3.3V.
VIN (+1.2V)	P	Power supply input ; +1.2V.
VIN_OUTSIDE(+1.9V)	P	+1.9V for powering RF section. This voltage is generated internally on the module from the 3.3V supply for all current module versions. Leave these pins open.
3V3RTC	P	For module versions without Real Time Clock (RTC) option, and for module versions with RTC option where the RTC function is not used, this pin should be left open. For module versions with RTC option, and the RTC function is used, then this pin should be connected to the positive terminal of a 1F capacitor connected to GND. This capacitor will power the RTC circuits in the DM870 IC when the module power supply is switched off.
GND	P	Ground (GND) connection for power supply 0V, signal returns and shielding.

SPI

SPI_DOUT	O	SPI data from DM870 to host controller.
SPI_DIN	I	SPI data from host controller to DM870.
SPI_CLK	I	SPI clock from host controller to DM870. Maximum recommended frequency is 2MHz, typical frequency is 1MHz. See Note 2 below.
SPI_NCS0	I	SPI chip select from host controller to DM870.
PDOUT1	O	This signal is used as SPI_REQ, SPI request signal, from DM870 to host controller for eDMP applications. Logic 1 indicates that there is an SPI message waiting to be read, the host controller should start the SPI clock and read any changed registers. Logic 0 indicates that all changed register messages have been read and the message buffer is empty. Also GPIO-06.
SPI_NCS1	I	Not used. Leave open.

UART

RXD1	I	UART1 input to the DM870, used for shell access. BridgeCo recommends providing a connection to an external RS-232 transceiver and DB9 connector to connect to a PC COM port. Such a connection can be used for product development debugging, and for module programming control on the product manufacturing line and for module control during certification procedures.
TXD1	O	UART1 output from the DM870, used for shell access. BridgeCo recommends providing a connection to an external RS-232 transceiver and DB9 connector to connect to a PC COM port. Such a connection can be used for product development debugging, and for module programming control on the product manufacturing line and for module control during certification procedures.
RXD0	I	UART0 input. Optionally used for controlling an iPod via UART.
TXD0	O	UART0 output. Optionally used for controlling an iPod via UART.



Data Sheet: CR Series
JukeBlox Networked Media Modules

AUDIO

AV2DATA0	O	I2S or left justified audio data output. Typically connected to external D/A converter input or to external DSP for further audio processing. Used for main left and right channel audio output data. See Note 3.
AV2CTRL0	O	LRCK, audio data word clock at the audio sample rate (Fs). Maximum currently supported frequency is 192kHz.
AV2CTRL1	O	MCLK, audio master clock at 256Fs. This can be used to clock an external D/A converter or DSP.
AV2CLK	O	SCLK, audio data bit clock at 64Fs. Allows for up to 32 audio data bits per sample word.
AV4DATA1	O	SPDIF format output. Can support samples rates up to 192kHz, so the maximum instantaneous frequency on this pin is 24.576MHz.
AV4DATA0	I	SPDIF input. Not used at present. Leave open.
AV2DATA1	O	I2S or left justified audio data output. Not used at present. Leave open.
AOUTLP/AOUTLN, AOUTRP/AOUTRN	O	Differential stereo output from PWM-DAC, right and left channels. These signals require analog low pass filtering. BridgeCo is not recommending using the PWM-DAC outputs because of the potential for high out-of-band noise and uncharacterized audio quality. BridgeCo recommends using an external D/A converter connected to AV2DATA0.
AV2DATA2	I	I2S or left justified audio data input. Can be driven from an optional external A/D converter used to interface to iPod analog output or other analog audio sources. If not used, leave open.
AV2DATA3	I	I2S or left justified audio data input. Not used at present. Leave open.

CONTROL

NCS3	I	BIST activate. Low-active input to invoke the Built In Self Test (BIST) function. This only applies to factory fresh modules. After JB2 firmware is loaded, this signal becomes GPIO-17 and is currently not used. DM870-internal pull-up. Leave this pin open.
PDOUT0	I	Factory Reset. GPIO-04. Return the CnE to factory settings. High-active input, DM870-internal pull-down. Pull to GND with a 10kohm resistor, unless return to factory settings from a hardware control is needed. Normally, return to factory settings is controlled from the host controller via SPI register. This pin is only monitored during the boot up process.
VCO0	I	Infrared sensor input. GPIO-05. This is a Schmitt-Trigger input and can handle inputs with slow slopes. Used for aDMP firmware builds for infrared remote control sensor output connection to DM870. For applications with a host controller, pull this pin to +3.3V via a 10kohm resistor.
AV3CLK	O	ETH_NRESET Low-active reset for the on-board ethernet PHY. This output is driven by the DM870. GPIO-12. Leave this pin open.
AV3CTRL0, AV3CTRL1	I/O	I2C_SCL, I2C_SDA bus created by GPIO-13 and GPIO-14. No internal pull-ups; Use 4.7kohm pull up resistor on each pin to +3.3V. Maximum frequency is 400kHz.
NRESET_MOD	I	Low-active input to reset the module. This signal must be driven by an external reset generator, or by a GPIO output from a host controller. See the application section of this data sheet for the timing requirements for NRESET_MOD. Includes internal 10K pull-up resistor to +3.3V.
NPD_RF	I	Active low input to shut down the power for the 802.11 RF section. Internal 10kohm pull-up resistor to +3.3V. Leave open if powering down the RF section is not required.

ETHERNET

ETH_RX-, ETH_RX+, ETH_CT, ETH_TX+, ETH_TX-	M	Ethernet signals between the magnetics (transformer) on the module and the external RJ45 connector. See Note 4. Maximum bit rate is 100Mbps.
ETH_LED_SPEED, ETH_LED_ACT	O	3.3V push-pull outputs (max. ±12mA) to drive the ethernet LEDs. 100Mbps speed mode and activity are indicated by the outputs being low. Connect to LEDs through 220ohm resistors.

USB

USB_DN, USB_DP	M	USB data signals, normally connected to type A connector, USB switch or iPod dock connector. Maximum bit rate is USB High Speed at 480Mbps.
USB_VBUS	M	Analog input for monitoring USB type A connector power. Connect to the +5V power which is driving the USB type A connector power pins. If this pin drops below 4.6V, then the DM870 will drive the USBVBUSDRV signal low to control an external power MOSFET to disconnect +5V power from the USB type A connector. See Note 5.
USBVBUSDRV	O	Logic output to control an external MOSFET that is in series with USB type A connector power. See USB_VBUS above and Note 5.

JTAG

TMS,TCK,TDI, TDO	I/O	JTAG port for DM870. Leave open.
------------------	-----	----------------------------------

SSM

SSMD4, SSMD5, SSMD6, SSMD7	I/O	Can be used to drive external shift registers to make extended GPIO signals (see Note 6), or as individual GPIO signals, or to make an SD card interface. SD card firmware is not supported at present in JB2. Can be mapped to GPIO #s 08,09,10,11. Leave open if not used.
SSMD0, SSMD1, SSMD2, SSMD3, SSMCLK, SSMCP, SSMCMD, SSMWP	I/O	Used to make an SD card interface. SD card firmware is not supported at present in JB2. Leave open.

VIDEO

AVOCLK, AVOCTRL0, AVOCTRL1, AVOCTRL2, AV0DATA0, AV0DATA1, AV0DATA2, AV0DATA3, AV1DATA0, AV1DATA1, AV1DATA2, AV1DATA3	O	ITU-R BT.656 digital video output signals. Optionally used to make a TVout menu display, or to display decoded album art. Can be connected to video D/A converter (see Note 7), or connected to a video DSP.
--	---	--

GPIO (not already mentioned elsewhere in this table)

A22	O	GPIO18 Reserved for NOR flash address A22. Leave open.
A23	O	GPIO-16 Reserved for NOR flash address A23. Leave open.
NWAIT	I/O	GPIO-15 Not currently assigned. Leave open.
NCS2	I	GPIO-19 Assigned to iPod dock connector iPod NDETECT. See Note 8.
VCO1	I/O	GPIO-07 Not currently assigned. Leave open.
MMIICRS	I/O	GPIO-00 Not currently assigned. Leave open.
MIICOL	I/O	GPIO-01 Not currently assigned. Leave open.
MIITXER	I/O	GPIO-02 Not currently assigned. Leave open.
MIITXCLK	I/O	GPIO-03 iPod dock connector Accessory Power signal. See Note 8.

MII

MIITXD0, MIITXD1, MIIRXD0, MIIRXD1	I/O	Can be used, with GPIO signals above, to drive an external ethernet PHY. This is not supported by JB2 firmware. Leave open.
------------------------------------	-----	---

LCD

LCDD0, LCDD1, LCDD2, LCDD3, LCDD4, LCDD5, LCDD6, LCDD7, LCDD8, LCDD9, LCDD10, LCDD11, LCDD12, LCDD13, LCDD14, LCDD15, LCD16, LCDD17, LCDCLK, LCDCTRL0, LCDCTRL1, LCDCTRL2, LCDCTRL3	O	Uses optional J1 LCD connector. Connect to local LCD display. See Note 9. Leave open if not used.
---	---	---

Notes:

1. Signal type codes:
 - I – 3.3V level Digital Logic Input into the DM870
 - O – 3.3V level Digital Logic Output from the DM870
 - IO – 3.3V level Digital Logic Input and Output (bi-directional) signal
 - M – Miscellaneous, see text for description
 - P – Power Supply
2. For SPI timing diagram for eDMP applications, please see:
BridgeCo_JB2x - DeviceControlProtocol_Registers_v_2_1.pdf, or later version.
For detailed setup and hold timing details, see DM870 IC data sheet:
dat_DM870_16_datasheet.pdf, or later version.
3. For audio port timing diagrams, and for detailed setup and hold timing, please see DM870 IC data sheet:
dat_DM870_16_datasheet.pdf, or later version.
4. For example ethernet external schematic, see:
CR Module Ethernet_V1.0.pdf, or later version.
5. For example USB schematics, see:
CR Module USB_V1.0.pdf, or later version.
6. For example use of extended GPIO shift registers, see CE2 schematic:
A EVMCE2-4_schematic.pdf, or later version.
7. For example connection to a video D/A converter, see CE2 schematic:
A EVMCE2-4_schematic.pdf, or later version.
8. iPod dock connector pin and GPIO assignments are under discussion. Please contact BridgeCo for recommendations for iPod dock connections to CR870 module.
9. For example connection to an LCD display, see CE2 schematic:
A EVMCE2-4_schematic.pdf, or later version.
10. BridgeCo has a set of example motherboard schematics that shows example external circuitry that is typically connected to the module. Please check the BridgeCo customer portal for a copy of these example schematics.
11. Please check the BridgeCo Customer Portal DOWNLOAD area for the latest version of BridgeCo documents. Go to bridgeco.com, click on Client Login button. If you do not have an account, please contact BridgeCo.

8.2.2 Connector PIN Assignments

J2 – Media Connector

Function	GPIO	IC PIN	Signal	PIN Number		Signal	IC PIN	GPIO	Function
			GND	1	2	GND			
			VIN (+3.3V)	3	4	VIN (+3.3V)			
			VIN (+3.3V)	5	6	VIN (+3.3V)			
			GND	7	8	GND			
			VIN (+1.2V)	9	10	VIN (+1.2V)			
			VIN (+1.2V)	11	12	VIN (+1.2V)			
			GND	13	14	GND			
			VIN_OUTSIDE (+1.9V)	15	16	VIN_OUTSIDE (+1.9V)			
			GND	17	18	GND			
		F4	3V3RTC	19	20	GND			
			GND	21	22	TMS	B20		JTAG
			GND	23	24	TCK	A20		
				25	26	TDI	B19		
				27	28	TDO	A19		
SPI		E17	SPI_DOUT	25	26	SPI_NCS0	D16		SPI
		F17	SPI_DIN	27	28	SPI_NCS1	D15		
		D17	SPI_CLK	29	30	NRESET_MOD			Module reset input SPI_E_CLK SPI_E_SDO
		C17	TXD0	31	32	SSMD6	B16	GPIO-10	
		A18	RXD0	33	34	SSMD4	C15	GPIO-08	
		B17	RXD1	35	36	SSMD2	A15		
Debug UART		A17	TXD1	37	38	SSMD1	C14		GPIO-17 BIST activate GPIO-19 iPod NDETECT
			GND	39	40	SSMCMC	A14		
SPI_E_NCS	GPIO-11	C16	SSMD7	41	42	SSMWP	C11		
SPI_E_SDI	GPIO-09	A16	SSMD5	43	44	NCS3	M18		
		B15	SSMD3	45	46	NCS2	L18		
		B14	SSMD0	47	48	GND			
		C13	SSMCLK	49	50	USB_VBUS			
		C12	SSMCP	51	52	GND			
			GND	53	54				
			GND	55	56	AOUTRN	K2		USB
			USB_DN	55	56	AOUTRP	J2		
			USB_DP	57	58	GND			
			USBVBUSDRV	59	60	PDOUT1	L1	GPIO-06	SPI_REQ
			GND	61	62	VCO1	L2	GPIO-07	
		H3	AOUTLP	63	64	PDOUT0	M1	GPIO-04	Factory reset
		J3	AOUTLN	65	66	VCO0	M2	GPIO-05	
			GND	67	68	AV3CLK	U3	GPIO-12	IR input ETH NRESET
		K20	A23	69	70	AV0CTRL0	M3		
		K19	A22	71	72	AV1DATA3	P3		Video Output
I2C SDA	GPIO-16	V1	AV3CTRL1	73	74	AV1DATA2	R1		
I2C SCL	GPIO-18	V2	AV3CTRL0	75	76	AV1DATA1	R2		
	GPIO-14		AV0CTRL2	77	78	AV1DATA0	R3		
			AV0CTRL1	79	80	GND			
			AV0CLK	81	82	AV2CTRL1	T1		MCLK
			AV0DATA3	83	84	GND			
			AV0DATA2	85	86	AV2CLK	R4		SCLK
			AV0DATA1	87	88	GND			
			AV0DATA0	89	90	AV4DATA1	W2		SPDIF output SPDIF input
			GND	91	92	AV4DATA0	Y1		
LRCK		T2	AV2CTRL0	93	94	GND			
A/D data 1		T3	AV2DATA3	95	96	ETH_LED_ACT			Ethernet
A/D data 0		T4	AV2DATA2	97	98	ETH_LED_SPEED			
D/A data 1		U1	AV2DATA1	99	100	MICRS	Y14	GPIO-00	iPod Access Power
D/A data 0		U2	AV2DATA0	101	102	MICOL	W14	GPIO-01	
			GND	103	104	MIITXER	V10	GPIO-02	
			ETH_RX+	105	106	MIITXCLK	V11	GPIO-03	
			ETH_RX-	107	108	MIITXD0	W10		
			ETH_CT	109	110	MIITXD1	Y10		
			ETH_TX-	111	112	MHIRXD0	W12		
			ETH_TX+	113	114	MHIRXD1	Y12		
			GND	115	116	GND			
Free	GPIO-15	N18	NWAIT	117	118				
			NPD_RF	119	120				

Note: The IC PIN column indicates the pin number on the DM860 or DM870 integrated circuit. This allows for easy cross-reference to the DM860 or DM870 data sheet information.

J1 – LCD Connector

Function	GPIO	IC PIN	Signal	PIN Number		Signal	IC PIN	GPIO	Function
			GND	1	2	GND			
LCD Interface		Y7	LCDD0	3	4	LCDD1	W7	LCD Interface	
		V7	LCDD2	5	6	LCDD3	Y6		
		W6	LCDD4	7	8	LCDD5	V6		
		U6	LCDD6	9	10	LCDD7	Y5		
		W5	LCDD8	11	12	LCDD9	V5		
		U5	LCDD10	13	14	LCDD11	Y4		
		W4	LCDD12	15	16	LCDD13	V4		
		U4	LCDD14	17	18	LCDD15	Y3		
		W3	LCDD16	19	20	LCDD17	Y2		
			GND	21	22	GND			
LCD Interface		Y9	LCDCLK	23	24	LCDCTRL0	W9	LCD Interface	
		Y8	LCDCTRL1	25	26	LCDCTRL2	W8		
		V8	LCDCTRL3	27	28	GND			
			GND	29	30	GND			

Note: The IC PIN column indicates the pin number on the DM860 or DM870 integrated circuit. This allows for easy cross-reference to the DM860 or DM870 data sheet information.

9. Application Guidelines

9.1 Power Supply sequencing and Reset Timing

There are strict power sequencing and reset timing requirements.

- Power up the I/O voltage (3.3V) first and hold NRESET_MOD low.
- The core voltage (1.2V) must never be higher than (I/O voltage + 0.5 V).
- The core voltage (1.2V) must be within the specified core voltage limits less than 300ms after the I/O voltage (3.3V) reaches the specified I/O voltage limits.
- Throughout the power down process, the 3.3V supply must maintain a higher voltage than the 1.2V supply, until both have reached ground potential.
- To assure a proper IC reset, the power supplies must be present for a minimum time of 2ms before NRESET_MOD is de-asserted.

Please see the power and reset timing figure in Section 9.1.1 below.

9.1.1 Power up, Reset and Power Down Timing

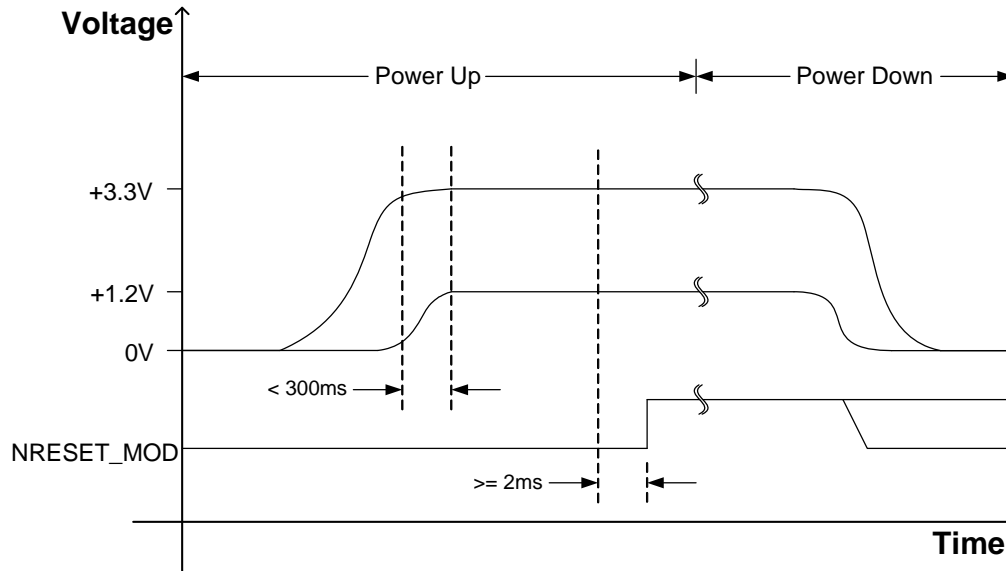

9.2 RF Considerations

Note that overall system, RF and WiFi performance is significantly affected by the product design, environment and the application. It is the responsibility of the product designer to ensure proper system level shielding (if required) and to verify performance and fitness for the given product features and applications.

The WiFi performance will be affected by the RF environment surrounding the CR module. Please ensure that the CR module is positioned in a “quiet” RF environment, as far away as possible from high frequency clock signals and any other sources of RF energy. Also, make sure the antenna is not shielded by any metal objects, for example loudspeakers or other metal parts. Please make sure that the power supplies, in particular the +1.9V supply, are quiet and free from noise.

BridgeCo recommends that systems implementing AirPlay should use a module configuration that includes top module shielding, as well as paying particular attention to system configuration and shielding.

10. Revision Control

Revision	Date / Author	Remarks
V3.6	August 4, 2011 / SHs	<ul style="list-style-type: none"> Added CR870-2S row to Section 4 Ordering Guide Updated Section 3.5 title to include 2S Updated Section 3.2 title to include 2D & 2S Removed "(Optional)" from WiFi-certified 802.11b/g entry on title page Updated TX EVM in Section 5.3 WiFi Specification from "< -5dB @ 6Mbps" to "< -9dB @ 6Mbps"
V3.5 b	May 15, 2011 / SHs	<ul style="list-style-type: none"> Updated the Feature list on Cover page Updated J1 & J2 "Connector PIN Assignments" tables: removed Power column & re-organised columns + added Notes Changed "Application Notes" title to "Application Guidelines" Updated Copyright date to "2011" Updated Table of Contents font styling Updated "Electrical Specifications" table: new logic I/O values Updated Top View of CR870-2A Board Picture: removed "Optional socket" label + added a Note Updated Bottom View of CR870-2A Board Picture: added a Note + labelled "+1.9V DC to DC converter" Added Note 11 to the "Pin Descriptions" section Updated "Regulatory Compliance and Quality" table: updated the Module Versions Passed for Radio Regulations Removed text before "Pin Descriptions" table
V3.5 a	May 6, 2011 / SHs	<ul style="list-style-type: none"> Updated "Power up, Reset & Power down Timing" figure
V3.5	May 5, 2011 / SHs	<ul style="list-style-type: none"> Added note to Module Weight section Updated the Ordering Guide – added new Q & R versions & shaded version K Updated appropriate Board Picture section titles with new versions Added note to "Board Dimensions and Weight" section Updated text in the "Power Supply sequencing and Reset Timing" section Added new Power Supply & Timing figure Updated the Key Connections table Updated "Key Connections" section title to "Pin Descriptions" Updated "Detailed Connector PIN Descriptions" section title to "Connector PIN Assignments" Updated J2 Media Connector table Re-imported Block Diagram as a wmf file
V3.4 b	March 3, 2011 / SHs	<ul style="list-style-type: none"> Updated J2 Media Connector table Updated Block Diagram
V3.4	February 5, 2011 / SHs	<ul style="list-style-type: none"> Updated "Ordering Guide" – added CR870-2P configuration, CR870-2M to 32MB SDRAM Updated Board Pictures subsection titles – 3.4 & 3.5
V3.3 c	January 24, 2011 / SHs	<ul style="list-style-type: none"> Updated "Board Pictures" subsection titles & notes – removing mention of Mfg code Updated "Ordering Guide" – removed Mfg column, fixed Top Shielding column
V3.3 b	January 22, 2011 / SHs	<ul style="list-style-type: none"> Updated "Board Pictures" subsection titles Added text to "Board Pictures" subsections

		<ul style="list-style-type: none"> Updated “Board Dimensions and Weight” subsection titles Added text to “Board Dimensions and Weight” subsections Removed all references to “DAB” as this option is no longer available Updated Block Diagram by removing DAB block and moving USB switch Updated Application Notes – RF Considerations section Updated the Ordering Guide table with L, M, N, O configurations and new explanatory shading
V3.3	January 14, 2011 / SHs	<ul style="list-style-type: none"> Updated “Board Pictures” section sub-section titles Updated “Top View of CR870-2F Mfg 100, CR870-2G Mfg 101, CR870-2I Mfg 100, CR870-2J Mfg 100, CR870-2K Mfg 100” section board image Removed “Bottom View of CR870-2C Mfg 200” section and associated image Updated Ordering Guide – removed CR870-2C Mfg 200 row and Bottom Module Shielding column Updated “Board Dimensions and Weight” section sub-section titles Removed section 7.4.2 – “Bottom View” and associated image Updated Side View drawing in “Top View and Side View of CR870 modules with top shields, with PIFA antenna” section
V3.2 b	January 11, 2011 / SHs	<ul style="list-style-type: none"> Updated Application Notes section with new subsections – “Power Supply sequencing and Reset Timing” & “RF Considerations” Updated subsection titles for Board Pictures section Updated subsection titles for Board Dimensions and Weight section Updated Ordering Guide with CR870-2K options
V3.2	January 3, 2011 / SHs	<ul style="list-style-type: none"> Updated the Ordering Guide
V3.1	December 3, 2010 / SHs	<ul style="list-style-type: none"> Added Top and Bottom View images of new CR870-2C Mfg 200 Added mechanical drawings of new CR870-2C Mfg 200 Updated the Ordering Guide with CR870-2C Mfg 200 information
V3.0	August 13, 2010 / SHs	<ul style="list-style-type: none"> Added Page Numbers to pages 1-3 Moved “Module Revision History” section to underneath “Revision Control” table Removed © from Table of Contents Added a Note to Section 3.3 – Top View of CR870-2G Amended Section 3.4 title to include more versions – Bottom View Updated Section 7.1 title to say “with PIFA Antenna” Updated Section 7.3 title to say “without PIFA Antenna” Updated “Regulatory Compliance” table Added Note underneath “Regulatory Compliance” table
V3.0	July 22, 2010 / SHs	<ul style="list-style-type: none"> Add mechanical tolerances note to “Board Dimensions and Weight “ section Updated Key Connections table with audio outputs data Added section numbering Added Table of Contents
V2.15	July 4, 2010 / SHs	<ul style="list-style-type: none"> Updated “Ordering Guide” table
V2.14	June 10, 2010 / SHs	<ul style="list-style-type: none"> Updated Frequency Band entry in “WiFi Specification” table
V2.13	June 6, 2010 / SHs	<ul style="list-style-type: none"> Updated “Ordering Guide” table
V2.12	May 27, 2010 / SHs	<ul style="list-style-type: none"> Updated TX EVM entry in “WiFi Specifications” table

		<ul style="list-style-type: none"> Updated Power Consumption entries in “Electrical Specifications” table Added Note to “Electrical Specifications” table Removed box from “Bottom View of CR870-2C version” photo Updated “Bottom View of CR870-2C version” title to “Bottom View of CR870-2B, CR870-2C, CR870-2G versions” Added “Top View of CR870-2G version” photo Updated “Top View” title to “Top View of CR870-2A version” Updated “Bottom View” to “Bottom View of CR870-2A version” Updated Notes in Board Dimensions section Added “Top and Side View of CR870-2G” drawings Updated Module Weight titles
V2.11	April 25, 2010 / SHs	<ul style="list-style-type: none"> Updated Power Consumption/WLAN Operating entry in “Electrical Specifications” table
V2.10	April 10, 2010 / SHs	<ul style="list-style-type: none"> Corrected “Module Connectors” section text to say “female board-to-board connectors” Updated Module Connectors table with correct “Male” Mating Connector Part Numbers
V2.9	March 22, 2010 / SHs	<ul style="list-style-type: none"> Renamed “WLAN Antenna Connectors” section to “WLAN UFL Antenna Connector” In the “WLAN Antenna Connectors” table, “receptible” became “receptacle” CR870-2G option and External Antenna UFL connector column added to Ordering Guide Power Consumption values added to Electrical Specifications table Added Absolute Maximum Ratings table Added Application Notes section NREST became NRESET_MOD for Pin 34 in Key Connections table SPI_REQ row added to Key Connections table SPI_REQ added to Function column of Pin 64 in J2-Media Connector table
V2.8	Feb. 24, 2010 / SHs	<ul style="list-style-type: none"> Added “Bottom View of CR870-2C version” image to “Overview” section
V2.7	Feb. 16, 2010 / SHs	<ul style="list-style-type: none"> Updated “Module Connectors” table
V2.6	Feb. 15, 2010 / SHs	<ul style="list-style-type: none"> Updated “Ordering Guide” table
V2.5	Feb. 10, 2010 / SHs	<ul style="list-style-type: none"> Updated “Ordering Guide” table Added new coaxial text in “WLAN Antenna Connectors” section Added manufacturer name to “Module Connectors” table
V2.4	Feb. 08, 2010 / SHs	<ul style="list-style-type: none"> Updated Rx Sensitivity description in “WiFi Specification” table
V2.3	Feb. 03, 2010 / SHs	<ul style="list-style-type: none"> “Key Connectors” table title changed to “Key Connections” Updated entries in “Key Connections” table Updated pins 1, 2, 25, 27, 58 & 60 in “J2 – Media Connector” table
V2.2	Feb. 02, 2010 / SHs	<ul style="list-style-type: none"> Added new items to “WiFi Specification” table Amended Block Diagram to show input of 1.2V instead of 1.8V
V2.1	Jan. 04, 2010 / SHs	<ul style="list-style-type: none"> Updated header layout Removed “CR860/CR870” from data sheet title Left justified Key Features list on front page New Ordering Guide table Updated Module Weights

V2.0	Jan. 02, 2010 / JWs and SHs	<ul style="list-style-type: none"> • New header and footer layout • Fit front and back Overview images onto one page • Bulletise Revision Control table
V1.1	Dec. 18, 2009 / SHs	<ul style="list-style-type: none"> • Changed Core Module name to "JukeBlox Networked Media Module(CR Series)" • Front page revisions: removed front and back images of board; inserted angled image of board; moved Key Features list to front page • Moved Disclaimers page to end of document • Replaced previous board images (front and back) in Overview section with better quality images • Added box and label to BridgeCo processor in Overview images • Revised Ordering Guide • Reduced Board Dimension drawings to fit on one page • Added mating connector part numbers to Module Connectors section.
V1.0	Dec. 9, 2009 / SHs	Initial version

Module Revision History

To be determined.

© 2011 by BridgeCo Inc

All rights reserved. This document is the sole property of BridgeCo. It contains information proprietary to BridgeCo. Reproduction or duplication by any means of any portion of this document without the prior written consent of BridgeCo is expressly forbidden.

Trademarks

The names of products of BridgeCo or other vendors and suppliers appearing in this document may be trademarks or service marks of their respective owners which may be registered in some jurisdictions.

Warranty Limitations

BridgeCo assumes no responsibility for inaccuracies, errors, or omissions in this document. BridgeCo assumes no responsibility for the use of this information, and all use of such information shall be entirely at the user's own risk. Prices and specifications are subject to change without notice.

Class B:

FEDERAL COMMUNICATIONS COMMISSION INTERFERENCE STATEMENT

This equipment has been tested and found to comply with the limits for a Class B digital device, pursuant to part 15 of the FCC Rules. These limits are designed to provide reasonable protection against harmful interference in a residential installation.

This equipment generates, uses and can radiate radio frequency energy and, if not installed and used in accordance with the instructions, may cause harmful interference to radio communications. However, there is no guarantee that interference will not occur in a particular installation. If this equipment does cause harmful interference to radio or television reception, which can be determined by turning the equipment off and on, the user is encouraged to try to correct the interference by one or more of the following measures:

- Reorient or relocate the receiving antenna.

- Increase the separation between the equipment and receiver.

- Connect the equipment into an outlet on a circuit different from that to which the receiver is connected.

- Consult the dealer or an experienced radio/ TV technician for help.

CAUTION:

Any changes or modifications not expressly approved by the grantee of this device could void the user's authority to operate the equipment.

Labeling requirements

This device complies with Part 15 of the FCC Rules. Operation is subject to the following two conditions: (1) this device may not cause harmful interference, and (2) this device must accept any interference received, including interference that may cause undesired operation.

Information for the OEMs and Integrators

The following statement must be included with all versions of this document supplied to an OEM or integrator, but should not be distributed to the end user.

This device is intended for OEM integrators only.

Please See the full Grant of Equipment document for other restrictions.

This device must be operated and used with a locally approved access point.

Information To Be Supplied to the End User by the OEM or Integrator

The following regulatory and safety notices must be published in documentation supplied to the end user of the product or system incorporating an adapter in compliance with local regulations. Host system

must be labeled with "Contains FCCID:TTUCR870-2Q", FCC ID displayed on label.

Modular with multiple Antennas

This radio transmitter FCCID: TTUCR870-2Q has been approved by FCC to operate with the antenna types listed below with the maximum permissible gain and required antenna impedance for each antenna type indicated. Antenna types not included in this list, having a gain greater than the maximum gain indicated for that type, are strictly prohibited for use with this device.

Antenna List

No	Manufacturer	Part No.	Antenna Type	Peak Gain
1	NISSEI	544116	Inverted-F	1.92 dBi for 2.4 GHz

Note: The antenna connector is I-pex type.

RF exposure warning

This equipment must be installed and operated in accordance with provided instructions and the antenna(s) used for this transmitter must be installed to provide a separation distance of at least 20 cm from all persons and must not be co-located or operating in conjunction with any other antenna or transmitter. End-users and installers must be provide with antenna installation instructions and transmitter operating conditions for satisfying RF exposure compliance.

Canada, Industry Canada (IC) Notices

This Class B digital apparatus complies with Canadian ICES-003 and RSS-210. Operation is subject to the following two conditions: (1) this device may not cause interference, and (2) this device must accept any interference, including interference that may cause undesired operation of the device.

Radio Frequency (RF) Exposure Information

The radiated output power of the Wireless Device is below the Industry Canada (IC) radio frequency exposure limits. The Wireless Device should be used in such a manner such that the potential for human contact during normal operation is minimized.

This device has also been evaluated and shown compliant with the IC RF Exposure limits under mobile exposure conditions. (antennas are greater than 20cm from a person's body).

This device has been certified for use in Canada. Status of the listing in the Industry Canada's REL (Radio Equipment List) can be found at the following web address:

<http://www.ic.gc.ca/app/sitt/reletel/srch/nwRdSrch.do?lang=eng>

Additional Canadian information on RF exposure also can be found at the following web address: <http://www.ic.gc.ca/eic/site/smt-gst.nsf/eng/sf08792.html>

Canada, avis d'Industry Canada (IC)

Cet appareil numérique de classe B est conforme aux normes canadiennes ICES-003 et RSS-210.

Son fonctionnement est soumis aux deux conditions suivantes : (1) cet appareil ne doit pas causer d'interférence et (2) cet appareil doit accepter toute interférence, notamment les interférences qui peuvent affecter son fonctionnement.

Informations concernant l'exposition aux fréquences radio (RF)

La puissance de sortie émise par l'appareil de sans fil est inférieure à la limite d'exposition aux fréquences radio d'Industry Canada (IC). Utilisez l'appareil de sans fil de façon à minimiser les contacts humains lors du fonctionnement normal.

Ce périphérique a également été évalué et démontré conforme aux limites d'exposition aux RF d'IC dans des conditions d'exposition à des appareils mobiles (les antennes se situent à moins de 20 cm du corps d'une personne).

Ce périphérique est homologué pour l'utilisation au Canada. Pour consulter l'entrée correspondant à l'appareil dans la liste d'équipement radio (REL - Radio Equipment List) d'Industry Canada rendez-vous sur:

<http://www.ic.gc.ca/app/sitt/reltel/srch/nwRdSrch.do?lang=eng>

Pour des informations supplémentaires concernant l'exposition aux RF au Canada rendez-vous sur : <http://www.ic.gc.ca/eic/site/smt-gst.nsf/eng/sf08792.html>

Modular with multiple Antennas

This radio transmitter IC: 3775B-CR8702Q has been approved by Industry Canada to operate with the antenna types listed below with the maximum permissible gain and required antenna impedance for each antenna type indicated. Antenna types not included in this list, having a gain greater than the maximum gain indicated for that type, are strictly prohibited for use with this device.

Antenna List

No	Manufacturer	Part No.	Antenna Type	Peak Gain
1	NISSEI	544116	Inverted-F	1.92 dBi for 2.4 GHz

Note: The antenna connector is I-pex type.

Modular information form OEM

Information to Be Supplied to the End User by the OEM or Integrator
The following regulatory and safety notices must be published in documentation supplied to the end user of the product or system incorporating an adapter in compliance with local regulations.

Host system must be labeled with "Contains IC: 3775B-CR8702Q "