



## Digital Wireless Stereo Headphones

Description [French]

Description [Spanish]

**RF-WHP01/02**

**User Guide** Guide de l'utilisateur Guía del Usuario

# Rocketfish RF-WHP01/RF-WHP02 Digital Wireless Stereo Headphones

## Contents

Introduction .....	3
Safety information .....	4
Features .....	6
Setting up your system .....	12
Using your system.....	17
Maintaining your system .....	23
Troubleshooting .....	24
Specifications.....	25
Legal notices .....	25
1 Year Limited Warranty.....	27
<b>Français .....</b>	<b>29</b>
<b>Español.....</b>	<b>30</b>

## Introduction

Congratulations on your purchase of a high quality Rocketfish digital wireless stereo headphones. This system represents the state of the art in 2.4 GHz wireless headphone design that gives you complete freedom while enjoying your music or movie without any limitations of headphone cables.

The system has a transmission range of up to 98 feet (WHP02) or 65 feet (WHP01) as well as a strong immunity to external interference and static. With an energizing docking station, your headphones can be easily recharged when they are not in use. This allows your headphones to be fully charged and always ready whenever you need them.

The system can be used with your CD player, DVD player, home-theater system, or computer.

This User Guide explains how to correctly install, operate, and get the best performance from your digital wireless stereo headphones. Read this User Guide carefully before installing your system, and then keep it handy for quick reference.

## Safety information



CAUTION  
Risk of Electric Shock  
Do Not Open



This lightning flash with the arrowhead symbol within an equilateral triangle is intended to alert the user to the presence of uninsulated dangerous voltage within the product's enclosure that may be of sufficient magnitude to constitute a risk of electric shock to persons.



The exclamation point within an equilateral triangle is intended to alert the user to the presence of important operating and maintenance (servicing) instructions in the literature accompanying the product.

### CAUTION

To reduce the risk of electric shock, do not remove screws, covers, or the cabinet. There are no user-serviceable parts inside. Refer servicing to qualified service personnel.

**Warning:** To reduce the risk of fire or electric shock, do not expose this apparatus to rain or moisture.

- Read these instructions.
- Keep these instructions.
- Heed all warnings.

- Follow all instructions.
- Do not use this apparatus near water.
- Clean only with a dry cloth.
- Do not block any ventilation openings. Install in accordance with the manufacturer's instructions.
- Do not install near any heat sources such as radiators, heat registers, stoves, or other apparatus (including amplifiers) that produce heat.
- Do not defeat the safety purpose of the polarized or grounding-type plug. A polarized plug has two blades with one wider than the other. A grounding type plug has two blades and a third grounding prong. The wide blade or the third is provided for your safety. If the provided plug does not fit into your outlet, consult an electrician for replacement of the obsolete outlet.
- Protect the power cord from being walked on or pinched particularly at plugs, convenience receptacles, and the point where they exit from the apparatus.
- Only use attachments or accessories specified by the manufacturer.
- Use only with the cart, stand, tripod, bracket, or table specified by the manufacturer, or sold with the apparatus. When a cart is used, use caution when moving the cart and apparatus combination to avoid injury from tip-over.
- Unplug this apparatus during lightning storms or when unused for long periods of time.
- Refer all servicing to qualified service personnel. Servicing is required when the apparatus has been damaged in any way, such as power-supply cord or plug is damaged, liquid has been spilled or objects have fallen into the apparatus, the apparatus has been exposed to rain or moisture, does not operate normally, or has been dropped.
- To reduce the risk of fire or electric shock, do not expose this apparatus to rain or moisture.
- The Shock Hazard Marking and Associated Graphical Symbol are provided on the supplied AC adapter.
- The apparatus shall not be exposed to dripping or splashing and objects filled with liquids should not be placed on the apparatus.
- The AC plug or an appliance coupler is used as the disconnect device. The disconnect device shall remain readily operable.
- Excessive sound pressure from headphones can cause hearing loss.



- Batteries (battery pack and batteries installed) should not be exposed to excessive heat such as sunshine or fire.

## Features

- 2.4 GHz digital wireless stereo headphones
- Transmits high quality audio over a radio frequency communication link
- Hidden antennas
- Strong immunity to external interference
- Low power consumption with 15 hours (WHP02) or 8 hours (WHP01) of continuous operating time

## Package contents

Examine the contents of the box for your digital wireless stereo headphones. The box should contain:



Headphones

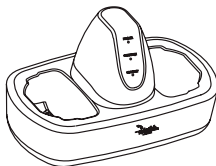

Docking station

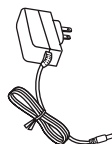

AC Adapter



Rechargeable batteries (2)



Microphone holder (WHP02)

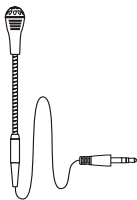

Microphone (WHP02)

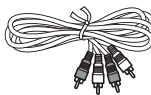

OR



(WHP02)  
Audio cable(s)



User guide

## Headphones back

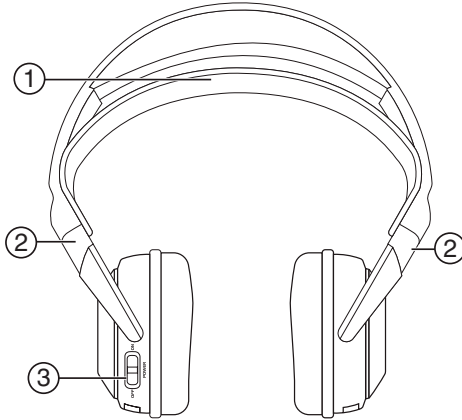

Item	Description
1	Self-adjustable headband
2	Swiveling hinge for angle adjustment (on the left and right ear pieces)
3	Power On/Off switch (on left earpiece)

## Headphones front and side

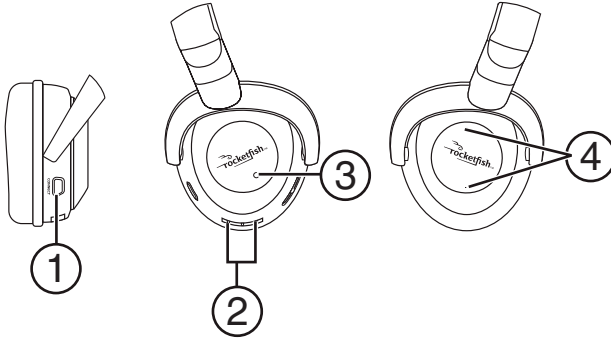

Item	Description
1	Manual connect button (on the left earpiece)
2	Charging contacts (on the left earpiece)
3	Power indicator (on the left earpiece)
4	Volume +/- button (on the right earpiece)

## Docking station front

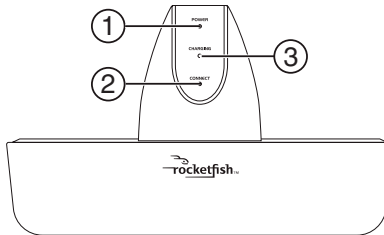

Item	Description
1	Power indicator
2	Connect indicator
3	Charging indicator

## Docking station back (WHP01)

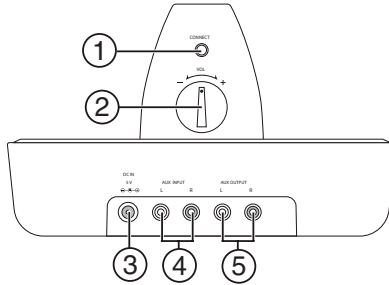

Item	Description
1	Manual connect button
2	Volume control knob
3	DC IN jack
4	AUX Input jacks
5	AUX Output jacks

## Docking station back (WHP02)

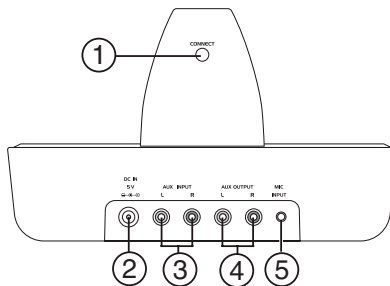

Item	Description
1	Manual connect button
2	DC IN jack
3	AUX Input jacks



Item	Description
4	AUX Output jacks
5	MIC Input jack

## Docking station top (WHP01)

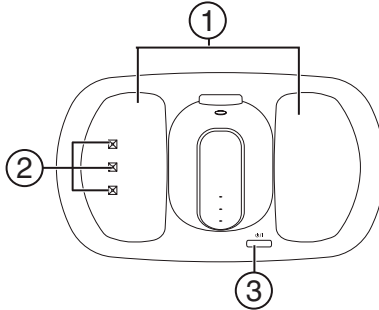

Item	
1	Headphone cradles
2	Charging pins
3	Power On/Off switch

## Docking station top (WHP02)

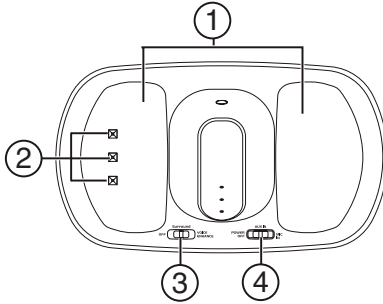

Item	Description
1	Headphone cradles
2	Charging pins
3	Off/Surround/Voice Enhance switch
4	Power Off/AUX IN/MIC IN switch

# Setting up your system

**Caution:** To prevent damage to your system, make sure all components are turned off before making the connections.

## Connecting the system to an A/V receiver with an external amplifier

**Note:** Before you listen to the system after all connections are set up, turn off the amplifier to stop sound from coming out of the amplifier speakers.

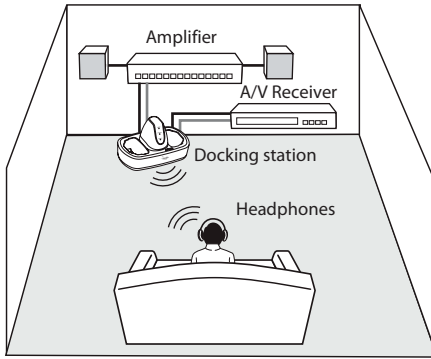

**To connect the docking station to your A/V receiver (such as CD or DVD player):**

- Using the supplied A/V cable, connect the A/V receiver audio output jacks to the docking station AUX INPUT jacks. Make sure that you connect the same colors of jacks together (the white to the white and the red to the red).

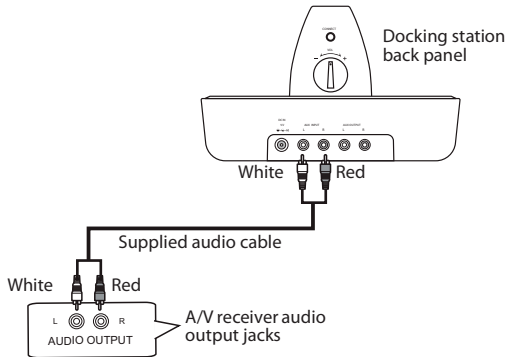

OR

**Note:** In case your A/V receiver has only a PHONES or LINE OUT jack, connect the two supplied audio cables together for use.

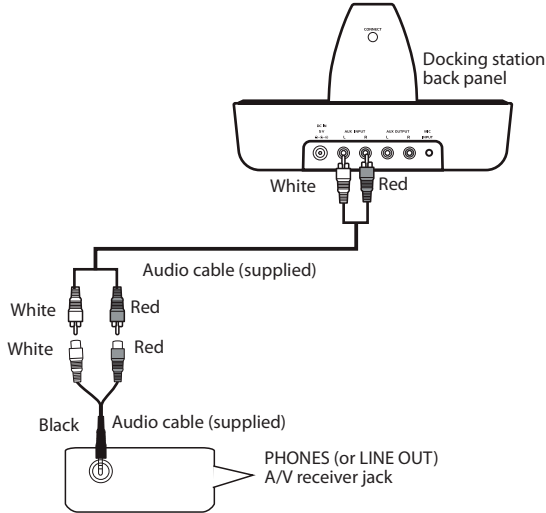

**To connect the docking station to your amplifier:**

- Using the supplied A/V cable, connect the amplifier audio input jacks to the docking station AUX OUTPUT jacks. Make sure that you connect the same colors of jacks together (the white to the white and the red to the red).

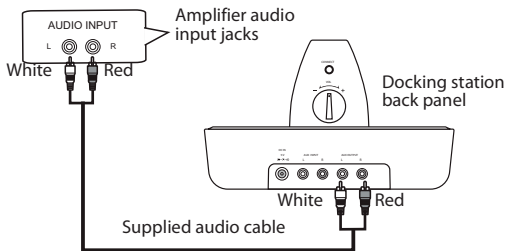

## Connecting the system to an A/V receiver with an internal amplifier

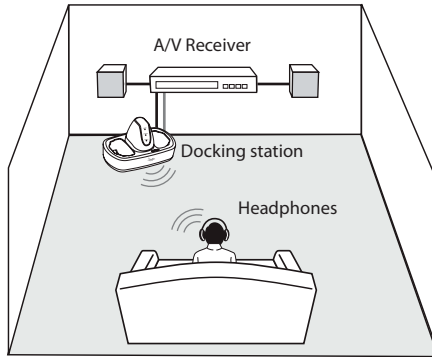

**To connect the docking station to your A/V receiver (such as DVD home theater):**

- Follow the same steps as “Connecting the system to an A/V receiver with an external amplifier” on page 12.

## Connecting the microphone (WHP02 only)

This microphone is designed for those who suffer from poor hearing and would enjoy watching TV with other family members or friends.

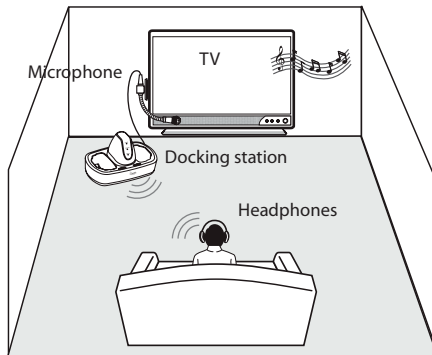

**Caution:** Before making the connections, adjust the volume of your television and headphones to the minimum level to avoid damage to your hearing.

### **To attach the microphone to your television:**

- 1 Bend and fix the microphone boom into the holder.

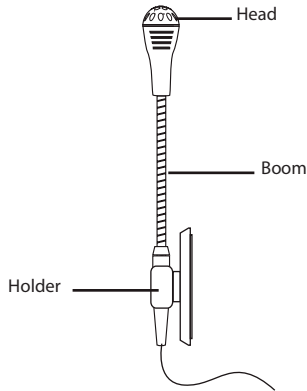

- 2 Remove the protective slip covering the double-side tape on the microphone holder.
- 3 Stick the holder onto your TV set where the microphone head is close to the TV speaker.

### **To connect the microphone to your docking station:**

- Connect the microphone plug to the docking station MIC INPUT jack.

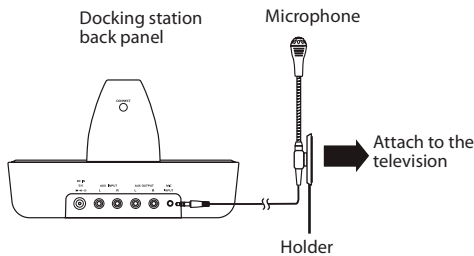

## **Connecting the AC adapter to the docking station**

**Caution:** To avoid risk of fire, and to prevent damage, only use the AC adapter supplied with your digital wireless stereo headphones. Make sure that power supply outlet matches the AC adapter's 120V before making the connection.

**To connect the AC adapter to your docking station:**

- 1 Connect the AC adapter connector to the docking station DC IN jack.

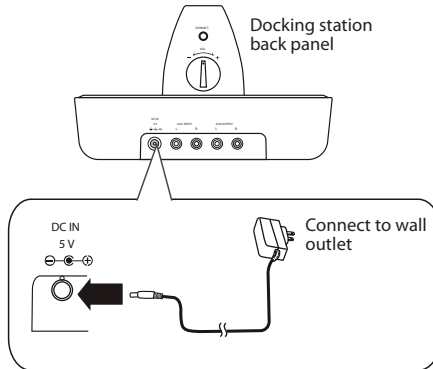

- 2 Connect the AC adapter plug to a wall outlet.

**Caution:** Plug the AC adapter into the wall outlet only after all other connections are completed.

## Using your system

### Installing or replacing headphone batteries

The headphones are powered by two AA rechargeable batteries. One battery is housed in the left earpiece and one battery is housed in the right earpiece.

**Notes:**

- Do not install non-rechargeable batteries.
- Make sure that all batteries are installed correctly.



### To install batteries in the headphones:

- 1 Unscrew and remove the cushions from the left and right ear pieces.  
<New Graphic>

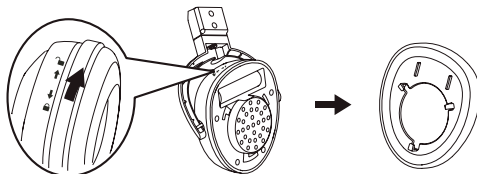

- 2 Insert one AA rechargeable battery into the left and one AA rechargeable battery into the right battery compartment. Make sure to align the + and - symbols inside the battery compartments.

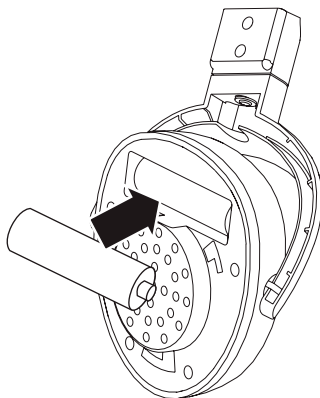

- 3 Put the left and right cushions back into place.

## Charging the headphones

**Note:** Before using the wireless headphones for the first time, make sure the batteries are fully charged for at least 16 hours. This will guarantee a longer operating lifetime of the batteries.

### **To charge the headphones:**

- Place the headphones onto the docking station cradles, and make sure the headphone charging contacts and the docking station charging pins make contact.

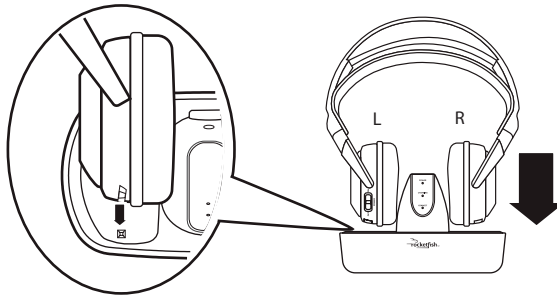

- The docking station charging indicator glows red to indicate the headphones are charging.
- When the headphones are fully charged (which takes approximately five hours), the docking station charging indicator turns green.

**Note:** It can take about five hours to charge the batteries. The batteries will last up to 15 hours (WHP02) or 8 hours (WHP01) with continuous use.

## **Establishing a link between the headphones and the docking station**

**Note:** The headphones can be charged whenever the docking station and headphone power slide switches are set to on or off.

### **To establish a link between the headphones and the docking station:**

- 1 Set the **POWER ON/OFF** switch located on the headphones' left earpiece to **ON**.

- 2 **WHP02 only:** Set the **POWER OFF/AUX IN/MIC IN** switch on the docking station to **AUX IN** or **MIC IN** for your listening needs. The power indicator glows red indicating that the docking station is plugged in and in standby mode.

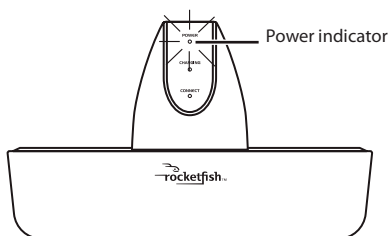

- If you want to listen to the sound from your A/V receiver, switch to **AUX IN**.
- If you want to listen to the sound from your microphone, switch to **MIC IN**.

OR

**WHP01 only:** Press the  button on the docking station. The power indicator glows red indicating that the docking station is plugged in and in standby mode.

**Notes:**

- If the headphone power is low, the indicator glows red. Charge the headphones. For charging details, see “Charging the headphones” on page 18.

- The headphones and docking station were pre-paired at the factory. When an active link is established between them, the **POWER** indicator on the headphones and the **CONNECT** indicator on the docking station glow green solidly.

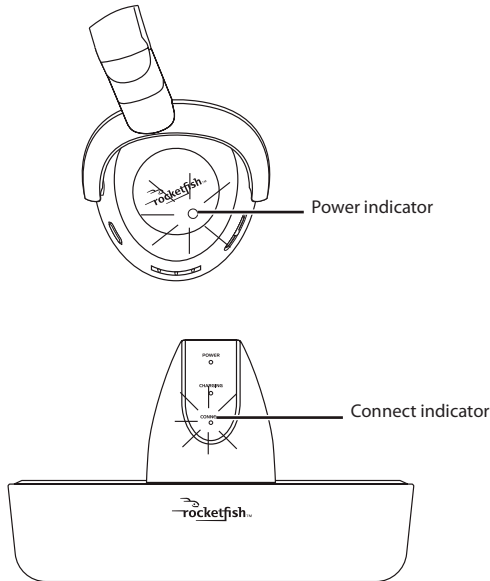

**Tip:** In case the **POWER** indicator on the headphones and the **CONNECT** indicator on the docking station **continue** to blink green after 30 seconds, it means that there is no active link between the headphones and docking station. Try to connect the system manually using the **CONNECT** button. For more information, see "Troubleshooting" on page 24.

## Listening to the Digital Wireless Stereo Headphones

### **To listen to the system:**

- 1 Set the headphones volume level to the minimum.
- 2 Turn on the headphones and docking station. Make sure that there is an active link between them.
- 3 Put your headphones on your head. Adjust the angles of the left and right ear pieces until you feel comfortable.

- 4 Turn on your A/V receiver and play the audio source.
- 5 Adjust the headphone volume to your normal listening level.

**Caution:** Continuous use at high volume may permanently damage your hearing.

**Notes:**

- If the system is connected to an A/V receiver with an external amplifier, turn off the amplifier to prevent sound from coming from the amplifier speakers.

### Adjusting the volume level (WHP01)

The volume control knob on the docking station is only used to adjust the output volume level of the audio source **connected to the AUX INPUT jack**. If the output volume is too low, you can increase the headphone volume level by adjusting the knob. If the output volume is too high, you can decrease the headphone volume level by adjusting the knob to prevent sound distortion.

**Note:** After the system is set up, we recommend that you adjust the output volume level of the audio source once.

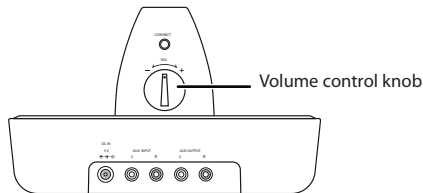

After the docking station volume is set up, always adjust the volume using the volume control buttons on the headphones whenever needed.

### Activating sound effects (WHP02)

Sound effect	Description	OFF/SURROUND/VOICE ENHANCE switch position
Surround Sound	A virtual-surround-sound effect which makes the sound more echoey and reverberant.	SURROUND
Voice Enhancement	An effect that makes a weak or muffled voice clear and concise as well as rejects any background noise.	VOICE ENHANCE
Off		OFF

## Turning off the system

### *To turn off the system:*

- 1 Set the **POWER ON/OFF** switch located on the headphones' left earpiece to **OFF**.
- 2 **WHP02:** Set the **POWER OFF/AUX IN/MIC IN** switch to **POWER OFF** on the docking station. The power indicator goes off.  
**WHP01:** Press and hold the  button on the docking station for more than three seconds. The power indicator on the docking station goes off.

## Maintaining your system

Use a soft cloth dampened with a weak solution of mild detergent and water. Dry the apparatus immediately afterwards with a clean cloth. Do not use abrasive cloth, thinners, alcohol, or other chemical solvents, because they may damage the finish or remove the panel lettering.

### **Cautions:**

- *Do not cover the ventilation openings with items, such as newspapers, table clothes, and curtains.*
- *If the power cord is damaged, it must be repaired by a qualified technician.*

# Troubleshooting

Read this User Guide carefully before using your digital wireless stereo headphones. Check this list for a possible troubleshooting solution before calling for service.

Problem	Solution
No sound	<ul style="list-style-type: none"> <li>• Check if the volume level of headphones, A/V receiver, or amplifier is set to minimum.</li> <li>• Make sure that all of the cables are connected correctly. Check to see if the power indicators of the headphones and docking station are lit solidly. If the indicators are blinking green, or blinking alternatively between red and green, refer to “No Communication between the headphones and docking station” below.</li> </ul>
Sound interference	<ul style="list-style-type: none"> <li>• Move the docking station slowly to find the best reception position for your headphones.</li> <li>• Shorten the distance between your headphones and the docking station. The maximum distance is 98 feet (WHP02) or 65 feet (WHP01).</li> <li>• Check if there are any obvious radio frequency interference sources near your system.</li> </ul>
No communication between the headphones and docking station	<ul style="list-style-type: none"> <li>• Make sure that the AC adapter is connected to the docking station.</li> <li>• Check if the two supplied batteries are installed into the headphone battery compartments.</li> <li>• Check if one or both batteries are exhausted.</li> </ul> <p><b>WHP02:</b> The headphones and docking station power indicators light up after the headphone switch is set to <b>ON</b> and <b>AUX IN/MIC IN</b> is set on the docking system.</p> <p><b>WHP01:</b> The headphones and docking station power indicators light up after the headphone switch is set to <b>ON</b> and the  button on the docking system is pressed.</p> <ul style="list-style-type: none"> <li>• If they are lit green solidly, then a communication link has been successfully established between the system.</li> <li>• If they are blinking green on one, or both units, then press and hold the <b>CONNECT</b> button on either headphones or docking station for two seconds. (The headphones' <b>CONNECT</b> button is on the left earpiece and the docking station's <b>CONNECT</b> button is on its back.) This puts the system into the “connection mode” for about 30 seconds. The system proceeds with the connection process between the headphones and docking station. While in “connection mode”, the LED indicators of headphones and docking station blink between red and green alternatively. When an active link is established between the headphones and docking station, the LED indicators are solid on and will not blink.</li> </ul> <p><b>Note:</b> Try pressing the <b>CONNECT</b> button again if the LED indicators keep blinking after 30 seconds.</p>

## Specifications

Speaker	40 mm Ferrite
Impedance	32 ohm
Sensitivity	86dB +/- 4dB
Headphone type	Circumaural
Headband	Auto Adjusting Headband
Wireless type	2.4 Ghz ISM band
Distance	98 feet (30 m) line-of-sight (WHP02) 65 feet (20 m) line-of-sight (WHP01)
Speaker input power	10 mW / 30 mW

## Legal notices

### FCC Part 15

This device complies with Part 15 of the FCC Rules. Operation of this product is subject to the following two conditions: (1) this device may not cause harmful interference, and (2) this device must accept any interference received, including interference that may cause undesired operation.

### FCC warning

Changes or modifications not expressly approved by the party responsible for compliance with the FCC Rules could void the user's authority to operate this equipment.

### Information for Users on Disposal of Old Equipment

#### [European Union]

*Note: This symbol is only valid in the European Union.*





This symbol indicates that the electrical and electronic equipment should not be disposed as general household waste at its end-of-life. Instead, the product should be handed over to the applicable collection point for the recycling in accordance with your national legislation.

By disposing of this product correctly, you will help to conserve natural resources and will help prevent potential negative effects on the environment and human health that could otherwise be caused by inappropriate waste handling of this product. For more information about collection point and recycling of this product, please contact your local municipal office, your household waste disposal service or the shop where you purchased the product.

Penalties may be applicable for incorrect disposal of this waste, in accordance with national legislation.

### **[Other Countries Outside the European Union]**

If you wish to dispose of this product, please do so in accordance with applicable national legislation or other rules in your country for the treatment of old electrical and electronic equipment.

# 1 Year Limited Warranty

Rocketfish Products ("Rocketfish") warrants to you, the original purchaser of this new **RF-WHP01/WHP02** ("Product"), that the Product shall be free of defects in the original manufacture of the material or workmanship for one (1) year from the purchase of the Product ("Warranty Period"). This Product must be purchased from an authorized dealer of Rocketfish brand products and packaged with this warranty statement. This warranty does not cover refurbished Product. If you notify Rocketfish during the Warranty Period of a defect covered by this warranty that requires service, terms of this warranty apply.

## ***How long does the coverage last?***

The Warranty Period lasts for one year (365 days), beginning on the date you purchased the Product. The purchase date is printed on the receipt you received with the product.

## ***What does this warranty cover?***

During the Warranty Period, if the original manufacture of the material or workmanship of the Product is determined to be defective by an authorized Rocketfish repair center or store personnel, Rocketfish will (at its sole option): (1) repair the Product with new or rebuilt parts; or (2) replace the Product at no charge with new or rebuilt comparable products or parts. Products and parts replaced under this warranty become the property of Rocketfish and are not returned to you. If service of Products and parts are required after the Warranty Period expires, you must pay all labor and parts charges. This warranty lasts as long as you own your Rocketfish Product during the Warranty Period. Warranty coverage terminates if you sell or otherwise transfer the Product.

## ***How to obtain warranty service?***

If you purchased the Product at a retail store location, take your original receipt and the Product to the store you purchased it from. Make sure that you place the Product in its original packaging or packaging that provides the same amount of protection as the original packaging. If you purchased the Product from an online web site, mail your original receipt and the Product to the address listed on the web site. Make sure that you put the Product in its original packaging or packaging that provides the same amount of protection as the original packaging.

## ***Where is the warranty valid?***

This warranty is valid only to the original purchaser of the Product in the United States and Canada.

## ***What does the warranty not cover?***

This warranty does not cover:

- Customer instruction
- Installation
- Set up adjustments

- Cosmetic damage
- Damage due to acts of God, such as lightning strikes
- Accident
- Misuse
- Abuse
- Negligence
- Commercial use
- Modification of any part of the Product, including the antenna

This warranty also does not cover:

- Damage due to incorrect operation or maintenance
- Connection to an incorrect voltage supply
- Attempted repair by anyone other than a facility authorized by Rocketfish to service the Product
- Products sold as is or with all faults
- Consumables, such as fuses or batteries
- Products where the factory applied serial number has been altered or removed

REPAIR REPLACEMENT AS PROVIDED UNDER THIS WARRANTY IS YOUR EXCLUSIVE REMEDY. ROCKETFISH SHALL NOT BE LIABLE FOR ANY INCIDENTAL OR CONSEQUENTIAL DAMAGES FOR THE BREACH OF ANY EXPRESS OR IMPLIED WARRANTY ON THIS PRODUCT, INCLUDING, BUT NOT LIMITED TO, LOST DATA, LOSS OF USE OF YOUR PRODUCT, LOST BUSINESS OR LOST PROFITS. ROCKETFISH PRODUCTS MAKES NO OTHER EXPRESS WARRANTIES WITH RESPECT TO THE PRODUCT, ALL EXPRESS AND IMPLIED WARRANTIES FOR THE PRODUCT, INCLUDING, BUT NOT LIMITED TO, ANY IMPLIED WARRANTIES OF AND CONDITIONS OF MERCHANTABILITY AND FITNESS FOR A PARTICULAR PURPOSE, ARE LIMITED IN DURATION TO THE WARRANTY PERIOD SET FORTH ABOVE AND NO WARRANTIES, WHETHER EXPRESS OR IMPLIED, WILL APPLY AFTER THE WARRANTY PERIOD. SOME STATES, PROVINCES AND JURISDICTIONS DO NOT ALLOW LIMITATIONS ON HOW LONG AN IMPLIED WARRANTY LASTS, SO THE ABOVE LIMITATION MAY NOT APPLY TO YOU. THIS WARRANTY GIVES YOU SPECIFIC LEGAL RIGHTS, AND YOU MAY ALSO HAVE OTHER RIGHTS, WHICH VARY FROM STATE TO STATE OR PROVINCE TO PROVINCE.

Contact Rocketfish:

For customer service please call 1-800-620-2790

[www.rocketfishproducts.com](http://www.rocketfishproducts.com)

Distributed by Best Buy Purchasing, LLC

7601 Penn Avenue South, Richfield, Minnesota, U.S.A. 55423-3645

© 2008 Best Buy Enterprise Services, Inc.

All rights reserved. ROCKETFISH is a trademark of Best Buy Enterprise Services, Inc. Registered in some countries. All other products and brand names are trademarks of their respective owners.

[www.rocketfishproducts.com](http://www.rocketfishproducts.com) (800) 620-2709

Distributed by Best Buy Purchasing, LLC

7601 Penn Avenue South, Richfield, MN 55423-3645 USA

© 2008 Best Buy Enterprise Services, Inc.

All rights reserved. ROCKETFISH is a trademark of Best Buy Enterprise Services, Inc.  
All other products and brand names are trademarks of their respective owners.

Distribué par Best Buy Purchasing, LLC

7601 Penn Avenue South, Richfield, MN 55423-3645 USA

© 2008 Best Buy Enterprise Services, Inc.

Tous droits réservés. ROCKETFISH est une marque de Best Buy Enterprise Services, Inc.  
Tous les autres produits ou noms de marques sont des marques de commerce qui  
appartiennent à leurs propriétaires respectifs.

Distribuido por Best Buy Purchasing, LLC

7601 Penn Avenue South, Richfield, MN 55423-3645 USA

© 2008 Best Buy Enterprise Services, Inc.

Todos los derechos reservados. ROCKETFISH es una marca de Best Buy Enterprise Services, Inc.  
Todos los demás productos y marcas son marcas comerciales de sus respectivos dueños.

