

# SOUNDFREQ<sup>®</sup>

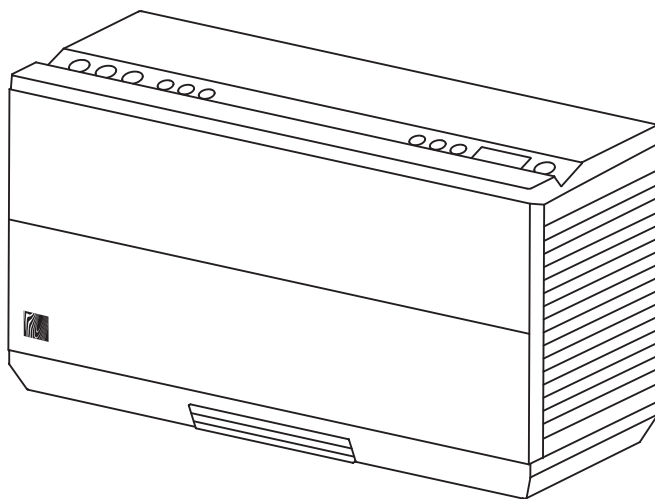



Sound Platform 2

SFQ-06



## User Manual

# Safety Information

	<b>CAUTION</b> RISK OF ELECTRIC SHOCK DO NOT OPEN	
	The lightning flash with arrowhead symbol, within an equilateral triangle is intended to alert the user to the presence of uninsulated "dangerous voltage" within the product's enclosure that may be of sufficient magnitude to constitute a risk of electric shock to persons.	
	The exclamation point within an equilateral triangle is intended to alert the user to the presence of important operating and maintenance (servicing) instructions in the literature accompanying the appliance.	
<b>WARNINGS:</b>		
TO REDUCE THE RISK OF FIRE OR ELECTRIC SHOCK, DO NOT EXPOSE THIS APPLIANCE TO RAIN OR MOISTURE.		
<b>DO NOT REMOVE COVER or OPEN THE CABINET.</b> Dangerous high voltages are present inside the enclosure. No user serviceable parts inside. Leave all servicing to qualified service personnel.		

## IMPORTANT SAFETY INSTRUCTIONS

1. Read these instructions.
2. Keep these Instructions.
3. Heed all Warnings.
4. Follow all instructions.
5. Do not use this apparatus near water.
6. Clean only with dry cloth.
7. Do not block any ventilation openings. Install in accordance with the manufacturer's instructions.
8. Do not install near any heat sources such as radiators, heat registers, stoves, or other apparatus (including amplifiers) that produce heat.
9. Do not defeat the safety purpose of the polarized or grounding - type plug. A polarized plug has two blades with one wider than the other. A grounding type plug has two blades and a third grounding prong. The wide blade or the third prong is provided for your safety. If the provided plug does not fit into your outlet, consult an electrician for replacement of the obsolete outlet.
10. Protect the power cord from being walked on or pinched particularly at plugs, convenience receptacles, and the point where they exit from the apparatus.
11. Only use attachments/accessories specified by the manufacturer.
12. Use only with the cart, stand, tripod, bracket or table specified by the manufacturer, or sold with the apparatus. When a cart is used, use caution when moving the cart/apparatus combination to avoid injury from tip-over.



PORTABLE CART WARNING  
(Symbol provided by RETAC)

13. Unplug this apparatus during lightning storms or when unused for long periods of time.
14. Refer all servicing to qualified service personnel. Servicing is required when the apparatus has been damaged in any way, such as power-supply cord or plug is damaged, liquid has been spilled or objects have fallen into the apparatus, the apparatus has been exposed to rain or moisture, does not operate normally, or has been dropped.
15. Apparatus shall not be exposed to dripping or splashing and no objects filled with liquids, such as vase, shall not be placed on the apparatus.
16. The mains plug is used as disconnect device and it shall remain readily operable during intended use. In order to disconnect the mains plug from the mains completely, the mains plug should be disconnected from the mains socket outlet completely.
17. The batteries (battery pack & batteries installed) shall not be exposed to excessive heat such as sunshine, fire or the like.

18. Do not place any naked flame sources, such as lighted candles, on the apparatus.
19. The battery used in this product must be properly recycled or disposed of. Please contact your local recycling center for proper battery handling and disposal instructions.

**FCC and IC Information:**

This device complies with Part 15 of the FCC Rules and RSS-210 of the IC Rules. Operation is subject to the following two conditions: (1) This device may not cause harmful interference, and (2) this device must accept any interference received, including interference that may cause undesired operation.

**Canada IC statements**

Le présent appareil est conforme aux CNR d'Industrie Canada applicables aux appareils radio exempts de licence. L'exploitation est autorisée aux deux conditions suivantes : (1) l'appareil ne doit pas produire de brouillage, et (2) l'utilisateur de l'appareil doit accepter tout brouillage radioélectrique subi, même si le brouillage est susceptible d'en compromettre le fonctionnement.

**Warning:** Changes or modifications to this unit not expressly approved by the party responsible for compliance could void the user's authority to operate the equipment.

**Note:** This equipment has been tested and found to comply with the limits for a Class B digital device, pursuant to Part 15 of the FCC Rules. These limits are designed to provide reasonable protection against harmful interference in a residential installation. This equipment generates, uses, and can radiate radio frequency energy and, if not installed and used in accordance with the instructions, may cause harmful interference to radio communications. However, there is no guarantee that interference will not occur in a particular installation. If this equipment does cause harmful interference to radio or television reception, which can be determined by turning the equipment off and on, the user is encouraged to try to correct the interference by one or more of the following measures:

- Reorient or relocate the receiving antenna.
- Increase the separation between the equipment and receiver.
- Connect the equipment into an outlet on a circuit different from that to which the receiver is connected.
- Consult the dealer or an experienced radio TV technician for help.

**Warnings:** The device meets the exemption from the routine evaluation limits in section 2.5 of RSS 102 and users can obtain Canadian information on RF exposure and compliance from the Canadian Representative Burnport Holdings Ltd. 72MT Belcher Pls, East, Calgary, Alberta, T2Z 2G1, CANADA. Tel: 403-257-4961

**FCC&IC Radiation Exposure Statement**

This equipment complies with FCC radiation exposure limits set forth for an uncontrolled environment and meets the exemption from the routine evaluation limits in section 2.5 of RSS 102.

1. This Transmitter must not be co-located or operating in conjunction with any other antenna or transmitter.
2. This equipment complies with FCC RF radiation exposure limits set forth for an uncontrolled environment. This equipment should be installed and operated with a minimum distance of 20 centimeters from user and bystanders.

For compatibility between the unit and another device with Bluetooth technology, consult the device's documentation and dealer. In some countries, there may be restrictions on using Bluetooth devices. Check with your local authorities.

 **Bluetooth** is a registered trademark of Bluetooth SIG, Inc

Please read rating label at the bottom of system for power input and other safety information.

### CAUTION — Proper Installation

- Install the system in a place which is level, dry and neither too hot nor too cold. The appropriate temperature is between 5 °C and 35 °C.
- Install the system in a location with adequate ventilation to prevent internal heat from building up inside the unit.
- Leave sufficient distance between the system and TV.
- Keep the system away from TV to avoid interference with TV.

### CAUTION — Proper Ventilation

To avoid risk of electric shock and fire, and to prevent damage, locate the apparatus as follows:

**Front:** No obstructions and open spacing.

**Sides / Top / Back:** No obstructions should be placed in the areas shown by the dimensions below.

**Bottom:** Place on the level surface. Maintain an adequate air path for ventilation by placing on a stand with a height of 10 cm (3-15/16") or more.

#### Front View:

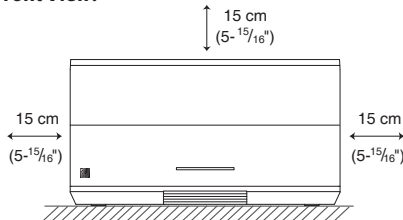

#### Side View:

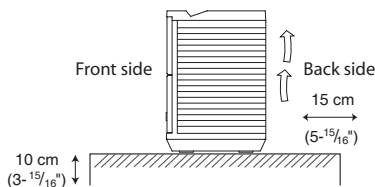

### Information for Users on Disposal of Old Equipment

#### [European Union]



This symbol indicates that the electrical and electronic equipment should not be disposed as general household waste at its end-of-life. Instead, the product should be handed over to the applicable collection point for the recycling in accordance with your national legislation.

**Attention:**  
This symbol is only valid in the European Union.

By disposing of this product correctly, you will help to conserve natural resources and will help prevent potential negative effects on the environment and human health that could otherwise be caused by inappropriate waste handling of this product. For more information about collection point and recycling of this product, please contact your local municipal office, your household waste disposal service or the shop where you purchased the product. Penalties may be applicable for incorrect disposal of this waste, in accordance with national legislation.

#### [Other Countries outside the European Union]

If you wish to dispose of this product, please do so in accordance with applicable national legislation or other rules in your country for the treatment of old electrical and electronic equipment.

QDID:

# Contents

---

<b>Getting Started</b> .....	<b>5</b>
Package Contents .....	5
Connecting the AC Adaptor .....	5
<b>System Overview</b> .....	<b>6</b>
Top View .....	6
Front View .....	6
Back View .....	7
Display Window .....	7
<b>Selecting the Sound Source</b> .....	<b>7</b>
<b>Basic Operations</b> .....	<b>8</b>
Turning on/off the System .....	8
Enabling Light Bar .....	8
Adjusting the Volume .....	8
Sound Mode .....	8
Activating the Power Save Mode .....	8
<b>Bluetooth</b> .....	<b>9</b>
Downloading the Soundraeq App .....	9
Establishing a Bluetooth Connection .....	9
Using Multiple Bluetooth Devices .....	10
Playing back from Macbook or Macbook Pro .....	10
Playing back from PC/Notebook .....	10
<b>FM</b> .....	<b>11</b>
Listening to FM Stations .....	11
Presetting Stations .....	12
<b>External Device</b> .....	<b>12</b>
<b>True-Wireless Connection</b> .....	<b>13</b>
<b>Charging an External Device</b> .....	<b>13</b>
<b>Optimizing Sound Quality</b> .....	<b>14</b>
<b>Troubleshooting</b> .....	<b>15</b>
<b>Technical Specifications</b> .....	<b>16</b>

# Getting Started

## Package Contents

Examine whether the following package contents are all included:

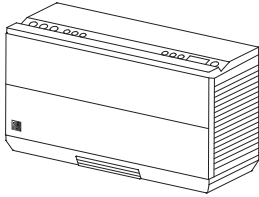

Main Unit

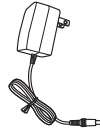

AC Adaptor



FM Antenna

---

## Connecting the AC Adaptor

**WARNING!** For optimal performance, use only the supplied AC adaptor.

- Ensure that power supply outlet matches with the unit AC's input 100-240V~, 50/60Hz before connection.

Connect one end of the AC adaptor to the **DC IN** jack of the unit and the other end to a power outlet.

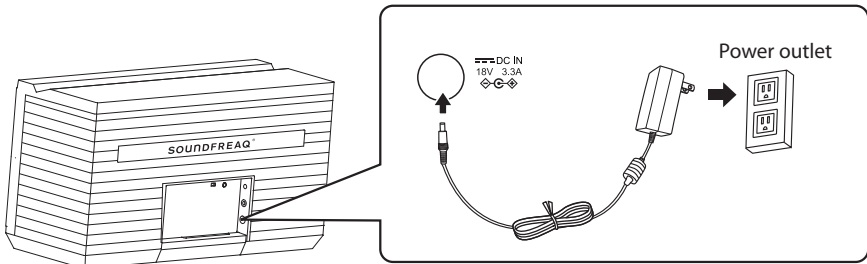

# System Overview

## Top View

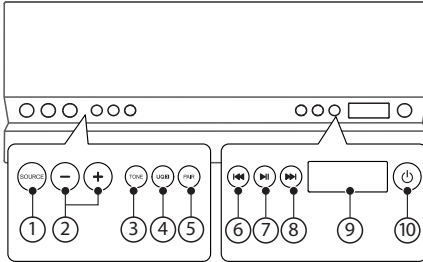

## Front View

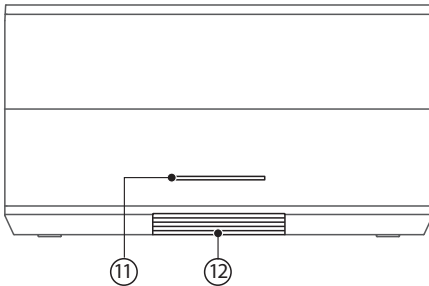

### 1. **SOURCE** button

Toggle among Bluetooth, AUX IN and FM tuner modes.

### 2. Volume +/- buttons

Press to increase/decrease the volume level.

### 3. **TONE** button

Toggle among Bright, Warm and Flat modes.

### 4. **UQ3** button

Press to activate the UQ3 sound effect. Press again to deactivate.

Hold separately this button on the two units at the same time to create a wireless connection between them. You need to buy another one for the better sound effect.

### 5. **PAIR** button

Press to place the system into Bluetooth mode.

### 6. **◀◀** (Previous/Rewind) button

In Bluetooth mode, press to skip a previous track. Hold to rewind a track fast.

In FM tuner mode, press to select a preset station or a frequency you desired. Hold to activate the auto scanning function.

### 7. **▶▶** (Play/Pause) button

In Bluetooth mode, press to play or pause a track.

In FM tuner mode, press to switch between preset and frequency displays.

### 8. **▶▶▶** (Next/fast forward) button

In Bluetooth mode, press to skip a next track. Hold to fast-forward a track.

In FM tuner mode, press to select a preset station or a frequency you desired. Hold to activate the auto scanning function.

### 9. Display

### 10. **⏻** (On/Standby) button

### 11. Light bar

Blinks once when any button is pressed.

Show the status of Bluetooth connection.

### 12. Cable tray

## Back View

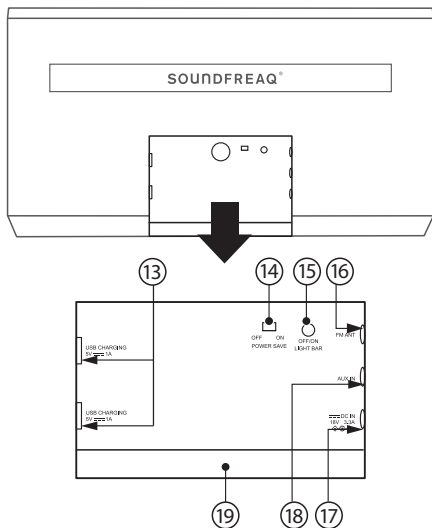

13. **USB CHARGING** jack  
Charge your external devices.
14. **POWER SAVE OFF/ON** switch  
Press to activate the power save mode.
15. **LIGHT BAR OFF/ON** button
16. FM jack
17. **DC IN** jack
18. **AUX IN** jack  
For transmitting an audio input signals from an external device.
19. Cable Door

## Display Window

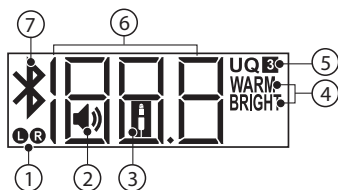

1. L/R indicator  
Appears when two units are connected wirelessly in the Bluetooth mode.
2. Speaker indicator  
Appears during the volume level is adjusted.
3. AUX IN indicator  
Appears when the system is in AUX IN mode.
4. Sound effect indicator  
Appears when the WARM or BRIGHT sound effect is activated.
5. UQ3 indicator  
Appears when the UQ3 sound effect is activated.
6. Multi-function display  
Indicates the changes of the frequency, preset and volume level.

## Selecting the Sound Source

This system enables you to access three sound sources - Bluetooth, FM tuner and External device.

- If you use the Soundfreak Remote App, tap the **SOURCE** button repeatedly on the App.
- Or, press the **SOURCE** button repeatedly on the System.



# Basic Operation

## Turning on/off the System

Tap the  button on the top to turn on the System .

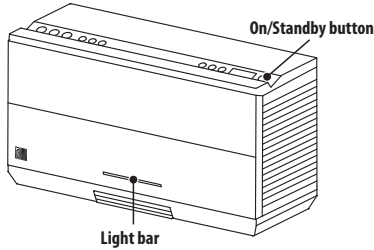

Tap the button again to turn off the System.

## Enabling the Light Bar

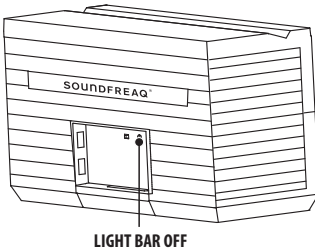

Press the button to turn off the light bar. Press again to turn on the light bar.

## Adjusting the Volume

You can adjust the volume level from 0 to 30. When one of sound sources is selected by tapping the volume +/- buttons.

During the process of adjusting, the speaker indicator will appear on the display.

## Sound Mode

Sound modes can be selected to enhance the type of music being played.

Tap the **TONE** to select the sound mode.

Each time you tap the button, the sound mode changes as follows:

"BRIGHT" ⇌ "WARM" ⇌ Cancel sound mode

## Activating the Power Save Mode

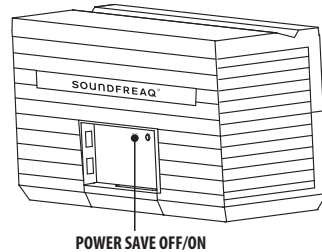

Switch the button to "OFF", the system will keep on all the time.

Switch the button to "ON". the system will power off automatically when the system is idle for 20 minutes.

# Bluetooth

## Downloading the Soundfreaq App



Soundfreaq

We have developed a Soundfreaq Remote App to give you full control from your Android devices while playing audio over the Bluetooth connection, please download the "Soundfreaq Remote App" in the App Store\* for FREE.

\* **iTunes Store** is an online store where you can free download or purchase applications for your devices. Apps are designed to expand the functionality of a device.

After pairing an iOS device with the system, you can download the free Soundfreaq Remote App in the iTunes store or on our website:

[www.soundfreaq.com](http://www.soundfreaq.com)

When the App installation is finished, you can control the playback from your iOS device. The app can be used as a remote control.



### **Warning!**



Do not unplug the AC adaptor from the unit when playing back a track over the Bluetooth connection.

## Establishing a Bluetooth Connection

### **Notes:**

- If your mobile phone supports A2DP protocol, its music will play through the unit.
- You can make a Bluetooth connection with an iPhone/iPad/iPod touch or any other Bluetooth-enabled devices with iOS.

1. Tap the  button to turn on the System.
2. Tap the **SOURCE** button repeatedly to select the Bluetooth mode.
  - The  indicator appears on the display.
3. Hold the **PAIR** button for two seconds on top of unit to put the system in pairing mode.
  - The  indicator and light bar start blinking together at a fast rate.
  - If you tap the **PAIR** button for more than 2 seconds during the process of pairing, the operation will be cancelled.
4. During this period, you can operate the iPad or Bluetooth-enabled device to pair with the unit within a 33 feet (10m) range.
  - Please check the user manual of the Bluetooth-enabled device with which you are initiating pair to learn about Bluetooth connection with any other devices.
5. Once the unit is detected and its name "**Sound Platform 2**" appears on the display of your Bluetooth-enabled device, key in the default password "**1234**" if a prompt requests it.

- The  indicator and light bar start blinking quickly to indicate that the unit and your device have entered into the connection mode.
  - After a Bluetooth connection is established successfully, the  indicator and the light bar will be solid on.
6. Select the desired music and press "Play" button on your device to play back the music.
  - If the  indicator and light bar remain on after blinking for 3 minutes, the pair was unsuccessful. Try again above steps 3 to 5.

---

### **Using Multiple Bluetooth Devices**

Only one device can be used at a time, but you can switch between different Bluetooth devices. Make sure each device you want to use has already been paired, to switch devices:

1. On the system, tap the **PAIR** button.
2. On Bluetooth device, select the connection to the system.

This device is now the connected device to the system, (the previous connected device is now disconnected). Repeat those steps to switch the connected device again.

**Note:** If the unit has no sound output, please check if the volume level of your Bluetooth device connected to the unit is set to the minimum, or the Bluetooth device is muted.

---

### **Playing back from Macbook or Macbook Pro**

1. In the desktop screen, Select the "Open Bluetooth Preference".
2. If there is any old "Sound Platform 2" records, remove them. Click the "Continue" button to proceed pairing process.

3. Once completed, the pairing success screen will come out.











**Note:** Don't quit the page immediately. You may notice that the previous dialog screen still shows the device not connected. Just ignore it. It's confusing to the user. In fact, it's connected already.

4. Open iTunes, play a song. Then use the mouse to click the Bluetooth icon at the top right hand corner of the desktop screen, select the "Sound Platform 2" option and then select the "Use as Audio Device (Stereo)". After a while (a few seconds), the music will come out from the system. If not, select the "Use as Audio Device (Stereo)" once again. The Sound Quality should be good.
- 

### **Playing back from PC/Notebook**

1. Press the "Start" button to open the "Device and Printers" dialog box.
2. Turn on the system and press the **PAIR** button on the unit to put the unit into the pair mode.
3. Select the "Add a device" in the "Device and Printer" dialog box. The "Sound Platform 2" icon will appear on the display.
4. Double click the "Sound Platform 2" icon and wait until the device has been added successfully.
5. Click the "Close" button to close the "Device and Printer" dialog box. A "Sound Platform 2" icon appears in the dialog box.
6. Double click the "Sound Platform 2" icon and the device connection screen will be shown.
7. Click the "Connect" button in the "Music and Audio" option.
8. Once connected, the pair indicator on the unit will be solid on and the connection success screen will be shown.

# FM

Press the Button	Functions
<p>Unit</p> 	<ul style="list-style-type: none"> <li>Switch between the frequency display and preset display. Tune the desired frequency or channel number based on the different display.</li> </ul> <div style="display: flex; align-items: center; justify-content: center;"> <div style="text-align: center;">  <p>Frequency display</p> </div> <div style="margin: 0 10px;">  </div> <div style="text-align: center;">  <p>Preset display</p> </div> </div> <ul style="list-style-type: none"> <li>Hold this button to enter saving mode. Press to save a channel. (see "Presetting a station")</li> </ul>
 	<ul style="list-style-type: none"> <li>Select a channel (from 01 to 20).</li> </ul> <div style="display: flex; align-items: center; justify-content: center;"> <div style="text-align: center;">  </div> <div style="margin: 0 10px;">  </div> <div style="text-align: center;">  </div> </div>
 	<p>Change frequency from 87.5MHz to 108.0MHz in the FM mode.</p> <ul style="list-style-type: none"> <li>Hold for more than one second to activate the Auto Scan function, and then release the button. The frequency will be scanned automatically until a radio station is found. Or press again to quit search while searching.</li> </ul>

## Listening to a Station

**Note:** Position the antenna as far away as possible from the AC adaptor, a TV, or other radiation source.

1. Plug the supplied FM antenna into the **FM.ANT** jack located on the back of unit.

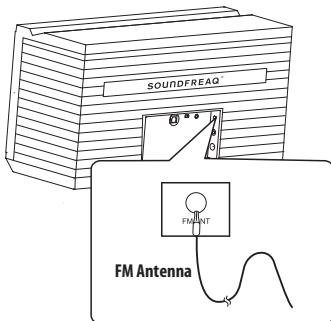

1. Tap the  button to turn on the System.
2. Tap the **SOURCE** button repeatedly to select the FM tuner mode.
3. Select a desired radio station for listening. For details, see "Presetting a Station")
4. Adjust the FM antenna's length and angle and direction until the best reception is obtained.
5. If necessary, adjust the volume level.

## Presetting a Station

1. Select FM tuner mode with the **SOURCE** button.
2. Switch to the frequency display if the display is channel number.
3. Tune a desired frequency. You can use either of the below methods to tune the frequency.

**A. Manual Tuning** - Briefly tap the ◀ / ▶ button repeatedly to move frequency to frequency (from 87.5 MHz to 108.0 MHz) until you find the desired station.

**B. Auto Scanning** - Hold the ◀ / ▶ button until the frequency display starts blinking. The frequency will be scanned automatically until a station is found.



4. Hold the ⏸ button to start storing a station.
  - The channel number starts blinking.



5. Use the ◀ / ▶ buttons on the System to select the channel number (from 01 to 20) to be set.
6. Press the ⏸ button again to store the frequency. The selected frequency will then be stored with the preset number.
  - The frequency display will be switched automatically to preset display after a few seconds.

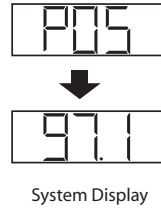

## External Device

You can enjoy the sound from an optional component such as a digital music player through the speakers of this unit. Be sure to turn off the power of each component before making any connections. For details, refer to the instruction manual of the component to be connected.

Connect an external device to the **AUX IN** jack on the back panel of the System using a stereo audio cable.

1. Tap the ⏻ button to turn on the System.
2. Tap the **SOURCE** button repeatedly to select the AUX IN mode.
3. Start playback on the external device.

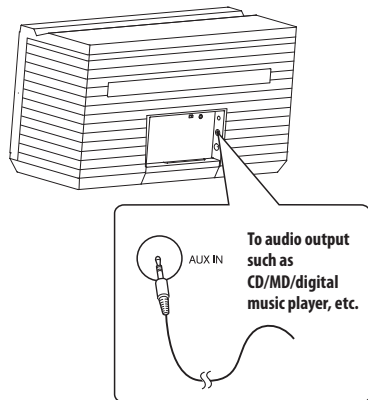

# True-Wireless Connection

Two systems can be connected wirelessly and they can be served as left and right speakers respectively during playback. You need to purchase one more system according to your need for experience.

1. Turn on the two systems by pressing the  $\phi$  button.
2. Hold the **UQ3** button on the one of the two systems firstly, and at the same time hold the **UQ3** button on the another system in the Bluetooth mode. The two light bars will blink. If the connection is successful, the two light bars will remain on.
- The system you first hold will be used as a main system and it also can be served as a left speaker with the  $\bullet$  indicator appearing on the display.

- Another system can be served as a right speaker with the  $\bullet$  indicator appearing on the display.
3. Build the Bluetooth connection between the main system and your Bluetooth-enabled device. For details about the Bluetooth connection, please refer to the "Establishing a Bluetooth Connection" on page 9.
4. Press the play button on your Bluetooth-enabled device to enjoy the music through the two systems.
- If you tap the Play/Pause, Previous/Next and Volume buttons on the main system, another system is also adjusted at the same time.
- The **UQ3**, **TONE** and **SOURCE** button need to be operated respectively.

# Charging an External Device

The two USB power ports can be used to charge most devices that allow for USB charging (including many mobile phones, smart phones and wireless headsets).

**Note:** Please use the USB power cord that came with your device to connect to the system to charge.

1. Tap the  $\phi$  button to turn on the System.
2. Open the door on the back of the system by the finger notch.

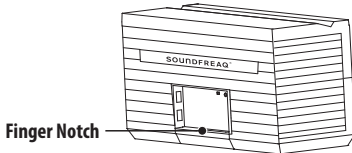

3. Push to open the cable tray on the front of the System.

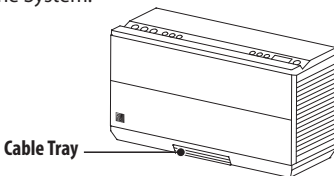

4. Take the USB cable go through the Cable Tunnel (from  $\text{A}$  to  $\text{B}$ ) before charging.

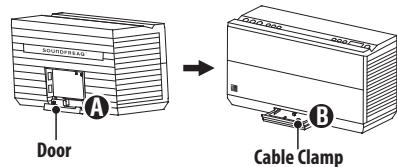

5. Connect your device to the USB port with a USB cord.

**Note:** Place the plug of the USB cord to the slot, and then close both the cable tray and door after charging.

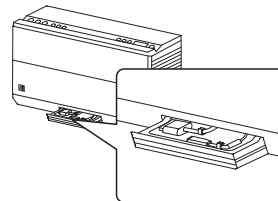

# Optimizing Sound Quality

**UQ3™** "U-Cubed" is an proprietary technology designed to create an ultra wide stereo sound field in digital music systems. With exceptional natural sound reproduction of high definition and fidelity, we create a listening experience where you feel like your speakers are separated much more than they are.

**To activate UQ3 on:**

- The unit, press the **UQ3** button to activate, press again to deactivate.
- On the Remote App, press the **UQ3** button to activate and deactivate.

**Tip:** The system has been tuned to a balanced acoustic profile. You can use the EQ settings on your playback device to customize the EQ balance to suit your personal preference. **Note:** Some custom EQ settings when combined with UQ3 enhancement may cause distortion.

**Tip:** The output volume is set by both the volume setting on the system and the source device. Both may be adjusted to set your preferred listening volume. Typically, sound quality is best when the volume of the source device is between 70-90%. **Note:** As with any speaker system, if the volume on both your source device and the speaker are at maximum output, it may cause distortion. When using an iOS device or other device that offers a "volume limit" feature, turn this setting off for higher volume listening.

**Tip:** Using high quality digital music files with low compression will improve acoustic performance.

# Troubleshooting

Check this list for a possible troubleshooting solution before calling for service.

In These Cases	Check the following points
Power does not come on.	<ul style="list-style-type: none"> <li>• AC adaptor is not inserted securely. Plug in securely.</li> </ul>
Hard to listen to broadcasts because of noise.	<ul style="list-style-type: none"> <li>• The antenna is not properly extended or positioned.</li> <li>• Tune to the correct radio channel/frequency.</li> <li>• Making sure the antenna is further away from any equipment that may be causing the noise or interference.</li> </ul>
Unable to operate the System from the remote control.	<ul style="list-style-type: none"> <li>• The path between the remote control and the sensor on the unit is blocked.</li> <li>• The battery of remote control is exhausted.</li> </ul>
No sound output.	<ul style="list-style-type: none"> <li>• Check if the volume level is set to the minimum.</li> <li>• Check if the volume level of your Bluetooth device connected to the system is set to the minimum.</li> <li>• Check to make sure your Bluetooth device is not muted.</li> </ul>
The system does not react when the buttons are pressed.	<ul style="list-style-type: none"> <li>• Remove and reconnect the AC power plug and turn on the system again.</li> </ul>
Bluetooth connection cannot be established.	<ul style="list-style-type: none"> <li>• When creating a Bluetooth connection between the unit and your device for the first time, if the connection is fail, you need to power off your device and power on again to clear the device name, and make the connection again.</li> </ul>
No sound output is via Bluetooth or Bluetooth connection cannot be restored automatically.	<ul style="list-style-type: none"> <li>• The unit may be powered off and powered on when playing back a track via Bluetooth connection. You need to make the connection again.</li> </ul>
If you find USB charging cannot perform after connecting your device to the USB jack on the unit.	<ul style="list-style-type: none"> <li>• Maybe your USB cable is not supported by the system, please try to use another USB cable.</li> </ul>



# Technical Specifications

Model	SFQ-06	
Name	Sound Platform 2	
Support Bluetooth	Bluetooth 1.2, 2.0 and 2.1 compliant	
Support Profile	A2DP	
Input Sensitivity	AUX Input	1200mV
Tuner	Band	FM
	Tuning Range	87.5 ~ 108.0MHz
	Frequency Step	100kHz
	Preset Stations	20
Input Terminal	External DC IN (for AC adaptor), AUX IN	
Power Source	DC 18V $\pm$ 3.3A (External DC IN)	
AC Adaptor	Input: AC 100-240V, 50/60Hz	
	Output: DC 18V $\pm$ 3.3A	
Dimensions (Approx.)	329mm(W) * 176.5mm(H) * 125mm(D)	
Weight	1.97Kg	

Design and specifications are subject to change without notice.



## Consignes de sécurité

Version Canada

	<b>ATTENTION</b> NE PAS OUVRIER - RISQUE D'ÉLECTROCUTION	
	Le symbole de l'éclair dans un triangle est destiné à mettre en garde l'utilisateur contre la présence de tensions dangereuses à l'intérieur du boîtier du produit, d'une puissance suffisante pour constituer un risque de choc électrique.	
	Le symbole du point d'exclamation dans un triangle est destiné à avertir l'utilisateur de la présence d'importantes instructions d'utilisation et d'entretien dans la documentation jointe à l'appareil.	
<b>AVERTISSEMENTS :</b> POUR RÉDUIRE LE RISQUE D'INCENDIE OU D'ÉLECTROCUTION, NE PAS EXPOSER CET APPAREIL À LA PLUIE OU À L'HUMIDITÉ. N'ENLEVEZ PAS LE COUVERCLE ET N'OUVREZ PAS LE BOÎTIER. Des tensions élevées dangereuses sont présentes à l'intérieur. Non réparable par l'utilisateur. Toutes les réparations doivent être effectuées par un personnel qualifié.		

**IMPORTANTES INSTRUCTIONS DE SÉCURITÉ**

1. Lisez attentivement ces instructions.
2. Conservez ces instructions.
3. Respectez tous les avertissements.
4. Suivez toutes les instructions.
5. N'utilisez pas cet appareil près de l'eau.
6. Nettoyez-le avec un linge sec uniquement.
7. Ne bloquez pas les fentes d'aération. Installez l'appareil conformément aux instructions du fabricant.
8. N'installez pas l'appareil près de sources de chaleur telles que radiateurs, registres de chaleur, poêles ou autres appareils (y compris les amplificateurs) produisant de la chaleur.
9. Ne détruisez pas la fonction de sécurité de la prise polarisée ou avec mise à la terre. Une prise polarisée comporte deux broches, l'une étant plus large que l'autre. Une prise avec mise à la terre comporte trois broches, la troisième étant la broche de terre. La broche plus large, ou la broche de terre, sont là pour votre sécurité. Si la prise fournie ne correspond pas à vos prises secteur, demandez à un électricien de la remplacer.
10. Protégez le cordon d'alimentation pour qu'il ne soit pas écrasé ou pincé, particulièrement au niveau de la prise de courant et au point où il sort de l'appareil.

11. Utilisez uniquement les accessoires spécifiés par le fabricant.
12. Utilisez uniquement avec le chariot, le pied, le trépied, le support ou la table spécifiés par le fabricant ou vendus avec l'appareil. Quand vous utilisez un chariot, soyez prudent lorsque vous déplacez l'ensemble chariot / appareil pour éviter les blessures en cas de renversement.
13. Débranchez l'appareil en cas d'orage ou si vous ne l'utilisez pas pendant une période prolongée.
14. Toutes les réparations doivent être effectuées par un personnel qualifié. Un entretien est requis lorsque l'appareil a été endommagé de quelque manière que ce soit, par exemple cordon d'alimentation ou prise de courant endommagés, liquide renversé sur l'appareil, objets tombés dans l'appareil, exposition de l'appareil à la pluie ou à l'humidité, ou si l'appareil ne fonctionne pas normalement ou est tombé.
15. L'appareil ne doit pas être exposé aux éclaboussures et aucun objet rempli de liquide ne doit être posé sur l'appareil.
16. La prise secteur est utilisée comme dispositif de déconnexion et doit rester facilement accessible pendant l'utilisation. Pour couper l'alimentation électrique de l'appareil, débranchez la fiche de la prise murale.
17. Les piles ne doivent pas être exposées à une chaleur excessive (soleil, feu, etc.).
18. Ne placez aucune source de flamme nue, telle que des bougies allumées, sur l'appareil.
19. La pile utilisée dans ce produit doit être correctement recyclée ou éliminée. Veuillez vous adresser à votre centre local de recyclage pour des instructions concernant la manipulation correcte et l'élimination de la pile.



AVERTISSEMENT RELATIF AU CHARIOT DE TRANSPORT (Symbole fourni par RETAC)

Pour assurer la compatibilité entre le système l'appareil et un autre appareil avec la technologie Bluetooth, consultez la documentation de l'appareil et renseignez-vous auprès du concessionnaire. Certains pays peuvent imposer des restrictions sur l'utilisation des appareils Bluetooth. Veuillez vous renseigner auprès des autorités locales.

**Bluetooth** est une marque déposée de Bluetooth SIG, Inc.

Veuillez lire l'étiquette apposée sous le système pour la tension d'entrée et d'autres informations de sécurité.

**Avvertissement :** Tout changement ou modification apportés à cet appareil sans l'approbation expresse de l'entité responsable de la conformité pourrait annuler le droit de l'utilisateur à se servir l'appareil.

**Informations FCC (Commission fédérale des communications U.S.) et IC (Industrie Canada) :**

Cet appareil est conforme à l'article 15 du règlement de la FCC. Son utilisation est soumise aux deux conditions suivantes : (1) cet appareil ne doit pas provoquer d'interférences préjudiciables, et (2) il doit accepter toute interférence reçue, y compris celles risquant d'engendrer un fonctionnement indésirable.

**Déclaration de la FCC et d'IC sur l'exposition aux irradiations :**

Cet équipement est conforme aux limitations prévues par la FCC pour l'exposition aux irradiations dans le cadre d'un environnement d'accès libre et est en conformité avec l'exemption d'évaluation de routine des limitations de la section 2.5 de la CNR-210.

1. Cet émetteur ne doit pas être situé à proximité ou fonctionner simultanément avec une autre antenne ou émetteur.
2. Cet équipement est conforme aux limitations prévues par la FCC pour l'exposition aux irradiations RF dans le cadre d'un environnement d'accès libre. Cet équipement doit être installé et mis en fonctionnement à une distance minimale de 20 cm de l'utilisateur et des personnes qui l'entourent.

**Remarque :** ce matériel a été testé et trouvé conforme aux limites de l'article 15 de la réglementation FCC pour les appareils numériques de classe B. Ces limites sont conçues pour fournir une protection raisonnable contre les interférences nuisibles dans une installation résidentielle. Ce matériel génère, utilise et peut émettre des fréquences radio et, s'il n'est pas installé et utilisé conformément aux instructions, peut causer des interférences nuisibles aux communications radio. Toutefois, il n'existe aucune garantie que des interférences ne se produiront pas dans une installation particulière. Si ce matériel cause des interférences nuisibles à la réception radio ou télévision, ce qui peut être déterminé en éteignant l'appareil, l'utilisateur est encouragé à essayer de corriger l'interférence par une ou plusieurs des mesures suivantes :

- Réorienter ou déplacer l'antenne de réception.
- Augmenter la distance entre l'appareil et le récepteur.
- Brancher l'appareil à une prise de courant sur un circuit différent de celui auquel le récepteur est branché.
- Consulter le revendeur ou un technicien radio/ télévision expérimenté.

**Avvertissements :** L'appareil répond à l'exemption de l'évaluation de routine des limites de la section 2.5 de la norme CNR-102 et les utilisateurs peuvent obtenir des informations canadiennes sur l'exposition aux radiofréquences et la conformité auprès du représentant canadien Burnport Holdings Ltd 72MT Belcher, East, Calgary, Alberta, T2Z 2G1, CANADA. Téléphone : 403-257-4961

**ATTENTION - Installation correcte**

- Installez le système sur une surface horizontale, dans un endroit sec et ni trop chaud ni trop froid. La température d'utilisation se situe entre 5°C et 35°C.
- Installez le système dans un lieu bien aéré pour éviter qu'il ne surchauffe.
- Laissez une distance suffisante entre le système et le téléviseur.
- Éloignez le système du téléviseur afin d'éviter les interférences avec ce dernier.

**ATTENTION - Ventilation correcte**

Pour prévenir tout risque de choc électrique, d'incendie, ou tout autre dommage, placez l'appareil comme suit :

Face avant : pas d'obstructions et un espace libre.

Côtés / dessus / arrière : aucun obstacle dans les zones indiquées ci-dessous.

Dessous : posez l'appareil sur une surface horizontale. Maintenez une circulation d'air suffisante pour la ventilation en plaçant l'appareil sur un support de 10 cm (3-15/16") de haut ou plus.

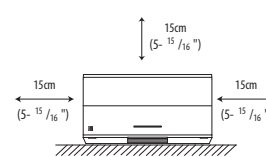
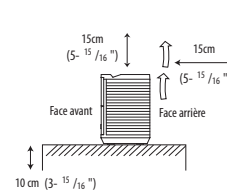
**Vue de face :****Vue de côté :**

QDID:

Save this manual