



9001ARF

Wireless Keyboard & Mouse Kit

User's Guide

Version 1.1





The information in this document is subject to change without notice and does not represent a commitment on the part of the vendor.

No warranty of representation, either expressed or implied, is made with respect to the quality, accuracy or fitness for any particular purpose of this document. The manufacturer reserves the right to make changes to the content of this document and/or the products associated with it at any time without obligation to notify any person or organisation of such changes.

In no event will the manufacturer be liable for direct, indirect, special, incidental or consequential damages arising out of the use or inability to use this product or documentation, even if advised of the possibility of such damages.

Copyright © 2001. All rights reserved

IBM, PC/AT and PS/2 are registered trademarks of International Business Machines Corporation.

Microsoft, Windows, and Windows NT are registered trademarks of Microsoft Corporation in the United States of America and/or other countries.

All other trademarks are trademarks of their respective holders.





Table of Contents

1	Introduction	1
	What's in this package.....	1
2	System Requirements.....	2
3	Hardware Installation.....	4
4	Software Installation.....	9
	4.1 Keyboard Driver Installation	9
	4.2 Mouse Driver Installation.....	9
5	Using the Keyboard and Mouse	11
	5.1 Using the Keyboard.....	11
	5.2 Using the Mouse Driver.....	13
6	Troubleshooting	18





1 Introduction

Congratulations on your purchase of this wireless RF keyboard and mouse! This keyboard and mouse will finally free you of the constraints of your desktop by providing a wireless connection between your keyboard/mouse and your PC. Pass around the keyboard or mouse during meetings without having to bother about a cable blocking your way or write e-mails and surf the Internet from the comfort of your living room couch!

This keyboard and mouse kit consists of a keyboard, a mouse and a receiver. The receiver is connected to your PC through a cable with both a keyboard and mouse connector. The keyboard and mouse can operate freely within a radius of at least 3.28 feet (1meter) from the receiver, which itself has a maximum range from your PC of around 3.28 feet (1 meter). Because the keyboard and mouse use radio frequencies to transmit the wireless signal it has no constrictions on viewing angles such as with infrared devices like your TV's remote control, etc.

Besides providing unprecedented freedom of movement when operating the keyboard or mouse, the kit also offers more extra functionality by introducing dedicated buttons for often used Internet browser functions as well as Sleep functions. (**Please note:** The Internet keys work only under Microsoft® Internet Explorer 5.0 or later version!). And last but not least, this package also provides a special driver, which provides unique shortcut functions.

In order to enjoy your keyboard and mouse to their full potential we recommended you read this manual carefully prior to installation.

What's in this package

- A wireless keyboard with palmrest
- A wireless mouse
- A receiver
- A driver CD
- Batteries (2 pcs of AA; 2 pcs of AAA)

2 System Requirements

- Microsoft® Windows NT® 4.0, Windows® 95, Windows® 98, Windows® ME, Windows® 2000 or Windows XP operating system
- Microsoft® Internet Explorer 5.0 or later version (for the Internet keys)
- CD-ROM drive (for CD and Video operation)
- Standard sound card (for CD and Video operation)
- The system supporting ACPI or APM II (for power management buttons)
- ATX mother board and ATX power supply (for power management buttons)

Please refer to table below for the other system requirements for the features.

Function Description	Operating System	
	Windows NT 4.0 / Windows 95 / Windows 98	Windows ME / Windows 2000 / Windows XP
Wireless Functionality	Available immediately after hardware installation	Available immediately after hardware installation
Keyboard Extra Multimedia Buttons	Requires keyboard driver installation (see driver CD for details)	Requires keyboard driver installation (see driver CD for details)
Keyboard Extra ACPI Keys	Requires enabling of system ACPI (Power Management) function	Available immediately after hardware installation
Mouse Driver Shortcut Function	Requires installation of mouse driver (see driver CD for details)	Requires installation of mouse driver (see driver CD for details.)
Keyboard Battery Low Function	Requires installation of keyboard driver (see driver CD for details)	Requires installation of keyboard driver (see driver CD for details)
Keyboard LED Light	Requires installation of	Requires installation of



Function	keyboard driver (see driver CD for details)	keyboard driver (see driver CD for details)
-----------------	---	---



3 Hardware Installation

Slide Switch Setting

Step 1: Make sure your PC is switched off.

Step 2: Take the **receiver** and select channel CH1 or CH2 by using the slide switch on the side of the receiver. (**Remember your selection.**)

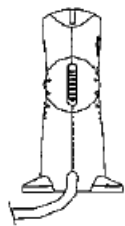

Back View of Receiver

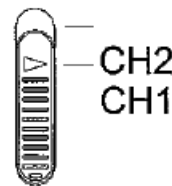

Channel Switch of Receiver

Step 3: Connect the **receiver** to your PC by plugging in the receiver's PS/2 mouse connector into the mouse port of your PC and the PS/2 keyboard connector into the keyboard port.

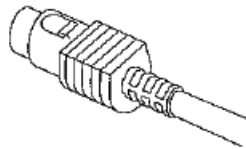

Mouse Connector

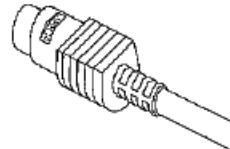

Keyboard Connector

Step 4: Take the **keyboard** and make sure the batteries on the back are installed correctly. (Follow the polarity signs in the battery compartment.)



Bottom View of Keyboard

Step 5: Use the slide switch on the back of the **keyboard** to select the same channel as the one selected in step 2 on the receiver.

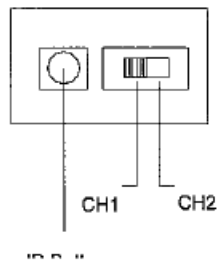

Channel Switch & ID Setting of keyboard

Step 6: Take the **mouse** and make sure the batteries on the back are installed correctly. (Follow the polarity signs in the battery compartment.)

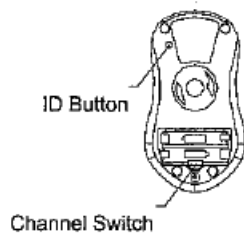

Bottom View of Mouse

Step 7: Use the slide switch in the battery compartment of the **mouse** to select the same channel as the one selected in step 2 and 5. (Open the battery cover to find the switch channel setting)

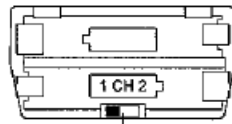

Channel Switch

Channel Switch of Mouse

Remarks:

1. The keyboard uses 2pcs standard UM-3 (AA) 1.5V batteries, and the mouse uses 2pcs UM-4 (AAA) 1.5V batteries.
2. Battery life is approximately 3-4 months, depending on the intensity of usage.
3. Make sure the receiver is placed in a location relatively free of strong electromagnetic or transmission sources in order to ensure optimal reception of the keyboard and mouse signal.

ID Setting

Each channel contains 256 sets ID. This extra ID-recognition function helps to protect against interference from other RF keyboards in the same environment.

After completing the hardware installation you must set the ID of the receiver, mouse and keyboard.

Step 1: Press the ID button on the top of the receiver once.



ID Button of Receiver

Step 2: Press the ID button on the bottom of the mouse once.

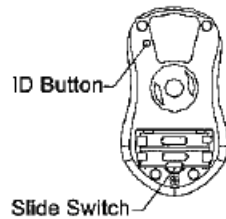

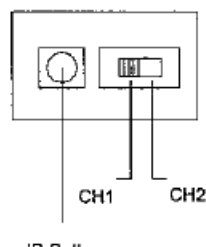

ID Button of Mouse

Step 3: Press the ID button on the bottom of the keyboard once.



ID Button of Keyboard

Remarks:

1. You must follow the procedure above to set the ID of receiver, mouse and keyboard. Once the receiver ID button is pressed you have 35 seconds to complete the entire process, or you will need to begin again.
2. Once the keyboard and receiver are plugged in, the yellow receiver light will flash. Once the ID is set, it will remain steadily lit.
3. When changing the batteries of keyboard or mouse, there is no need to reset all the ID's. Simply reset one of them.
4. When the keyboard batteries are low, a battery low icon  will show on the right-bottom corner of the Windows task bar instead of the KeyMaestro driver icon .

Detachable Palmrest

At your discretion, you may choose to connect the palmrest with keyboard.

To connect the palmrest with the keyboard please follow figure 1 & figure 2.

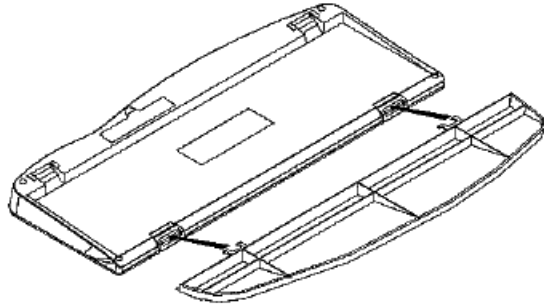

Figure 1

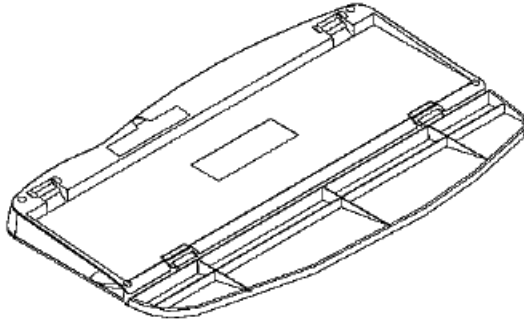

Figure 2





4 Software Installation

After finishing the hardware installation as described in this manual and starting up your PC, you should be able to immediately take advantage of the wireless function of the wireless keyboard and mouse. If the keyboard and mouse are not working properly, see Chapter 6 Troubleshooting for tips on how to solve your problem.

4.1 Keyboard Driver Installation

 If your operating system is Windows ME, Windows 2000 or Windows XP, you can immediately take advantage of the extra function buttons on the keyboard (except 'Battery Low' and 'LED Light' functions). But, if your operating system is Windows NT 4.0, Windows 95 or Windows 98, you will have to install the keyboard driver software to take advantage of these functions. The keyboard driver program is located on the driver CD included in the box.

1. Insert the driver CD into your computers CD-ROM drive.
2. Run the setup.exe in the keyboard-driver directory of the driver CD.
3. Follow the onscreen instructions to finish the installation procedure.
4. For detailed information on how to install the driver, please refer to the readme.htm file.

4.2 Mouse Driver Installation

 In order to take advantage of the special shortcut button functionality of the mouse you will have to install the mouse driver which is located on the driver CD included in the box.

1. Make sure the driver CD is in your computers CD-ROM drive.
2. Run the setup.exe in the mouse-driver directory of the driver disk.
3. Follow the on screen instructions to finish the installation procedure.



4. For detailed information, please refer to the `readme.htm` file.



5 Using the Keyboard and Mouse

5.1 Using the Keyboard



Besides the usual keys, this keyboard also has extra dedicated keys, which provide the following ACPI, multimedia and Internet functionality:

- **ACPI Keys:**

Your keyboard has the power management keys that are Power off, Sleep, and Wake up three keys. They are also can be called ACPI (Advanced Configuration and Power Interface) keys.









As these ACPI keys are performed not completely under Windows NT 4.0, Windows 95 and Windows 98; the KeyMaestro driver provides an option to enable the ACPI keys. When the option is enabled, the driver will take Windows' place to process these keys.





Note: For detailed information, please read the online help by right clicking the mouse on the KeyMaestro Keyboard icon  in the Windows task bar and selecting Help.

	Power Off	Closes the operating system and powers down the system. P.S: Although this key is a standard key under Windows 98, Windows 98 processes it as a Sleep key.
	Sleep	Puts your system to sleep (power-saving) mode. Any key will wake up your system and return to the previous working status. P.S: Windows NT 4.0 does not support Sleep function. This key will be processed as Power Off by KeyMaestro driver if the option is enabled.
	Wake Up	Wakes up your system and returns to the previous working status.

● **Multimedia Keys:**

There is a row of multimedia keys on the top of keyboard. The functions are described as below.

	Help	Display the help file on the screen.
	Shortcut	Provide you to create an easy access to the documents and programs you use most often. The default setting for Shortcut button is to launch Windows accessory program 'Notepad'.
	WWW Search	Launches to your Internet Browser application and go to the Search Engine web site.
	Favorites Folder	Opens My Favorite folder for you to select your favorite web site.
	WWW Home	Launches to your Internet Browser application which should be pre-installed. If you have installed two browsers in your system, the system default one will be opened. Mostly the system default is the later installed one.
	Volume Control	Controls the volume to up or down of your audio output to the speakers. Note: All these keys are not reprogrammable.
	Mute	Mutes the sound output. Repress this button to resume.
	Previous/ Fast Backward	Skips backward to the previous file/track or play backward fast when pressing once quickly. But, if you are using "Vendor Player", you have to press and hold the button and then the file/track will play backward fast (The "Vendor Player" is only for

		Windows 95, Windows 98 or Windows NT4.0 users).
	Next/ Fast Forward	Skips forward to the next file/track or play forward fast when pressing once quickly. But, if you are using 'Vendor Player', you have to press and hold the button and then the file/track will play forward fast (The "Vendor Player" is only for Windows 95, Windows 98 or Windows NT4.0 users).
	Eject	Ejects/ loads the CD tray.
	Play/Pause	When the CD or Video is playing, press this button to pause it, and press the button again to resume it from the current position.
	Stop	Stops the playing.

5.2 Using the Mouse Driver

After installing the mouse driver as described in Chapter 4 you will be able to startup the Mouse Control Panel by right clicking on the  KeyMaestro Mouse icon in the Windows task bar. This should appear after restarting your machine.

The Mouse Control Panel (KeyMaestro Mouse Properties) window consist of the following folders:

- ◆ **Buttons folder:**
allows you to change Button Configuration and Double Click Speed.
- ◆ **Pointers folder:**
allows you to change your favorite cursor shape.

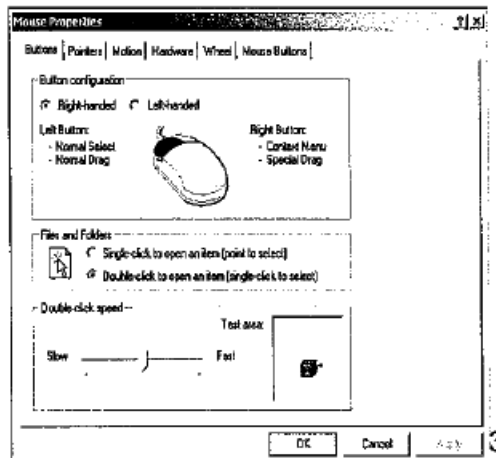



- ◆ **Wheel folder:**
allows you to change the speed of scroll wheel.



◆ **Mouse folder:**









allows you to change the scroll wheel function. There are 7 functions can be chose, including Quick Jump, Double Click, Window Zoom, Switch AP, Auto Panning, WWW Back and WWW Forward. The default of the scroll wheel is "Quick Jump".



The Definition of Mouse Extra Function:

Function	Definition
Quick Jump	Let you to open 8 special functions quickly. For the detailed, please refer to the " Quick Jump Function Introduction " in next section.
Double Click	Replace the "double click" movement to activate an application or function, it can save the valuable mouse-clicks.
Window Zoom	To magnify or de-magnify the data view of a document in an application that supports it. (this function is workable when the application you used is with the ctrl + wheel scrolling function, ie Word, Excel, PowerPoint and FrontPage ...)
Switch AP	Switch quickly from one opened application to the other applications without extra cursor move. Press the "Switch AP" button you set and scroll the wheel button to switch the applications.
Auto Panning	Move the cursor and then the document will scroll slowly in the direction you just moved.
WWW Back	Return to the last page you viewed.
WWW Forward	View the next page you viewed before.

Quick Jump Function Introduction

 Also, after installing the mouse driver and invoking the KeyMaestro mouse driver program you will have access to 9 special function icons by pressing the scroll wheel once. These 9 functions are:

	Mouse Control Panel	Activate the Mouse Control Panel Menu.
	Control Panel	Activate the "Control Panel" window.
	Horizontal Scroll Bar	Set the cursor to the horizontal scroll bar to scroll the document horizontally. (the function does not support Windows XP)
	Vertical Scroll Bar	Set the cursor to the vertical scroll bar to scroll the document vertically. (the function does not support Windows XP)
	Windows Explorer	Activate the 'Windows Explorer' window.
	Size Grip	Adjust the frame size of the windows you opened (the function does not support full screen. The function is also not performed when the frame of applications are not adjustable).
	Minimize All Windows	Allow you to minimize all the current opened applications immediately (this function is only performed when the applications are with the minimize function)
	Recall the Last Active Window	Recall the last active window.
	Exit	Exit the quick jump function panel.



6 Troubleshooting

If you are experiencing problems with your keyboard or mouse please check the following:

1. Take out the receiver's connector and check both the receiver's mouse and keyboard plug for possible broken pins. If the plugs appear normal then reinsert the plugs into their respective connectors on your PC.
2. Make sure the mouse plug is inserted in the mouse connector on your PC and the keyboard plug is inserted into the keyboard connector on your PC. Compare the icons on both the cable and backside of your PC if necessary.
3. Check to see if the batteries in the keyboard and mouse are installed correctly. Make sure the polarity of the batteries corresponds with the polarity signs in the battery compartment.
4. Replace the batteries to make sure the batteries are not low in power.
5. Check to see if the channel switch for the receiver, keyboard and mouse are set to the same channel. Try the alternate channel for the receiver, keyboard and mouse in case the initially selected channel appears to work improperly, other devices in the vicinity of the receiver may cause interference.
6. It is strongly recommended to place the receiver in front of the monitor in order to prevent signal disturbance from the monitor.
7. If your PC system's BIOS setup has options for the keyboard or mouse - make sure they are set to default settings. If you are not familiar with the BIOS, refer to your PC's manual for more information.
8. If you have problems using the sleep button - make sure that the power management in your PC has been enabled both in the BIOS and in Windows. For more information on your PC's BIOS settings - refer to your PC's manual. For more information on how to enable the power management features in Windows, refer to your Windows manual.
9. If you have problems using the extra browser buttons and/or the



special mouse functions - make sure you have installed the keyboard and mouse driver correctly as described in this manual's Chapter 4: Software Installation. Also check your hardware requirements meet those listed in this manual





10. Use the mouse only on a clean, flat, non-slippery surface in order to ensure smooth and accurate cursor action.
11. Keep all items away from direct sunlight, moisture, dirt, extreme heat and abrasive chemical (cleaning) solutions.
12. Should the receiver, the keyboard or mouse become accidentally immersed or splashed by liquids, switch off your PC immediately, unplug all items and refer to your dealer for further assistance. In these cases please refrain from using any of the items before consulting with your dealer!



FCC GUIDELINES

This equipment has been tested and found to comply with the limits for a Class B digital device, pursuant to Part 15 of the FCC Rules. These limits are designed to provide reasonable protection against harmful interference in a residential installation. This equipment generates, uses and can radiate radio frequency energy and, if not installed and used in accordance with the instructions may cause harmful interference to radio communications. However, there is no guarantee that interference will not occur in a particular installation. If this equipment does cause harmful interference to radio or television reception, which can be determined by turning the equipment off and on, the user is encouraged to try to correct the interference by one or more of the following measures:

- Reorient or relocate the receiving antenna
- Increase the separation between the equipment and receiver
- Connect the equipment into an outlet on a circuit different from that to which the receiver is connected.
- Consult the dealer or an experienced radio/TV technician for help.

The Class B digital apparatus meets all requirements of the Canadian Interference-Causing Equipment Regulation.

Cet appareil numérique de la class B respecte toutes les exigences du Règlement sur le matériel brouilleur du Canada.

Caution:

Any changes or modifications not expressly approved by the party responsible for compliance could void the user's authority to operate this equipment. Shielded interface cable, if any, must be used in order to comply with emission limits.

封底



3100504750
Version 1.1
December 2001
Printed in China





Clicking once more on the scroll wheel will close these icons.

Note: For more detailed information please read the online help by right clicking on the KeyMaestro  Mouse icon in the Windows task bar and select Help.

