

自助式移动支付机具

Hands-free Mobile Payment Devices

意锐小盒加强版使用说明书

InsPos S Scanning Device

Operation Instruction

INSPIRY 意锐

北京意锐新创科技有限公司

Beijing Inspiry Technology Co., Ltd.

版权所有

All rights reserved

郑重声明 Notice

意锐小盒加强版移动支付机具已在中国专利局和商标局注册。

InsPos S Mobile Payment Device has been registered in Patent Office and Trademark Office of People' s Republic of China.

本说明使用的商标、商号及图标均属于北京意锐新创科技有限公司或其授权人，并受中华人民共和国法律及国际条约保护。

All the trademarks and trade names used in this Instruction belong to Beijing Inspiry Technology Co., Ltd or its authorized persons, and are protected by the laws of People' s Republic of China and international treaties.

本说明书仅适用于书中所介绍的意锐小盒加强版移动支付机具的使用和使用条件及环境要求的说明。

This instruction applies only to the application, operation environment and environmental requirement of InsPos S.

本说明书的资料的正确性已经认真审核,但北京意锐新创科技有限公司对内容的解释有保留权。

The correctness of the information in this instruction has been carefully reviewed, but Beijing Inspiry Technology Co., Ltd retains the right of the interpretation of the contents.

本说明书的所有权属于北京意锐新创科技有限公司。

Inspiry claims the copyright of all material and information produced originally by our company.

本说明书未经北京意锐新创科技有限公司明确的书面许可，任何人不得作为任何其它的目的、以任何的形式或手段使用、复制或传播本说明书的其他部分。

No person, organization and/or company shall use, reproduce, disseminate or broadcast the content in any manner whatsoever without the written permission of Beijing Inspiry Technology Co., Ltd.

本说明书的内容，如有变动，恕不另行通知。如果您对本说明书未提出书面异议，则表明您接受了上述的条件。

The contents of this instruction are subject to change without notice. Without written objection, it is deemed that you have accepted and agreed to all the contents.

安全警告 Caution!

使用**意锐小盒加强版**设备时：

- 请勿把设备窗口对准在直射日光及高温物体的附近。
- 请勿设置在高温多湿的地方，及冷藏库等温度过低的地方，以避免读取器的电路、光学元件发生故障。
- 请勿设置在会碰到水的地方，以避免出现故障。
- 请勿在会产生电磁辐射的区域附近进行操作，避免影响读取器的正确识读。
- 请勿将读取器跌落或振动。
- 请勿随意拆卸。
- 请勿连接不适当的配件。

When you use InsPos S:

Do not expose the window of module to direct sunlight and high temperature

Do not install the module in a place subjected to high temperature, high humidity, or low temperature such as in cold store, to prevent the malfunction of the reader's circuitry and optical components.

Do not operate near the area where electromagnetic radiation is generated, to avoid the inaccuracy of reading.

Do not drop or vibrate the module

Do not disassemble or reassemble internal components

注意

- 本手册版权属于北京意锐新创科技有限公司所有。
- 随机所附赠软件之版权均属于本公司所有。
- *Inspiry claims the copyright of this instruction and software coming with the device.
- 本手册所涉及的其它商标均属于本公司之注册商标。
- *The trademarks involved in this instruction belong to Inspiry.
- 本公司保留对产品和手册之修改权利，恕不另行通知。
- *The contents of this instruction are subject to change without notice.



FCC ID: 2A0I3S-001

This device complies with Part 15 of the FCC Rules. Operation is subject to the following two conditions: (1) this device may not cause harmful interference, and (2) this device must accept any interference received, including interference that may cause undesired operation.

changes or modifications not expressly approved by the party responsible for compliance could void the user's authority to operate the equipment.

This equipment has been tested and found to comply with the limits for a Class B digital device, pursuant to Part 15 of the FCC Rules. These limits are designed to provide reasonable protection against harmful interference in a residential installation. This equipment generates, uses and can radiate radio frequency energy and, if not installed and used in accordance with the instructions, may cause harmful interference to radio communications. However, there is no guarantee that interference will not occur in a particular installation.

If this equipment does cause harmful interference to radio or television reception, which can be determined by turning the equipment off and on, the user is encouraged to try to correct the interference by one or more of the following measures:

- Reorient or relocate the receiving antenna.
- Increase the separation between the equipment and receiver.
- Connect the equipment into an outlet on a circuit different from that to which the receiver is connected.
- Consult the dealer or an experienced radio/TV technician for help.

Other information:

Hereby, [Beijing Inspiry Technology Co., Ltd.], declares that this InsPos S Scanning Device] is in compliance with the essential requirements and other relevant provisions of Directive 2014/53/EU.

目录 Contents

1. 产品介绍 Introduction.....	6
2. 意锐小盒加强版介绍 Introduction to InsPos S.....	8
2.1 意锐小盒加强版移动支付机具 Brief Introduction.....	8
2.2 意锐小盒加强版移动支付机具特点 Distinguishing features.....	8
2.3 意锐小盒加强版参数 Parameters.....	9
3. 意锐小盒加强版使用说明 InsPos S Instruction.....	10
3.1 设备连接 Device Connection.....	10
3.1.1 型号 PPS7200-5L 设备连接方式 Device Connection of PPS7200-5L.....	10
3.2 设备配置 Wi-Fi 及打印机 Configuration method of Connecting Wi-Fi and Printer.....	11
4. 搬运储藏信息 Handling and storage.....	12
4.1 储藏环境要求: Storage environment requirements:.....	12
4.2 搬运要求: Handling requirements:.....	12
5. 维护说明 Maintenance instruction.....	13
6. 常见问题介绍 Comment problem introduction.....	13
6.1. 设备如何安装 Device installation.....	13
6.2. 打印机问题 Printer problems.....	14
6.3. 联网问题 Networking problems.....	14
6.4. LED 灯光指示 Led light indication.....	15
6.5. 程序升级 device update.....	15
7. 机器的报废处理 Device disposal.....	15
8. 售后服务 After-sales service.....	15
9. 意锐小盒加强版参数 Parameters.....	17

1. 产品介绍 Introduction

“意锐小盒”是自助式二维码支付机具，支持 WiFi 上网及有线网络连接的移动支付智能硬件，一站式布署，即插即用，无需更改原收银系统。

“Inspiry Box” (hereinafter referred to as the InsPos) is hands-free mobile payment device, supporting Wi-Fi and wired network connection, which is easy to deploy, plug-and-play, and compatible with the original cash register system

移动支付及卡券核销于一体。Mobile payment and card verification are in one device.

强大的主扫、被扫两种支付方式适用于商场、超市、餐厅、医院、公交等各场景，兼容各种收银设备。

Two powerful payment methods--scan-with-phone camera and scan-phone-screen, apply to many scenarios such as shopping mall, supermarket, restaurant, hospital and public transportation. InsPos compatible with a variety of POS devices.

— 智慧收银 —

老式收银机，轻松升级



— 智慧收银 —

独立使用，轻巧便捷



充值——支付、转账 Recharge—Payment, transfer of account

就医——挂号、门诊、付费 Healthcare—Registration, outpatient service, payment

签到——展会会议、企业办公考勤 Registration—Exhibition or Conference registration, staff attendance

卡券——扫码核销优惠券、抵用券、积分 Card&Coupon—Scanning verification code of vouchers, coupons and loyal cards

交通——出租、高速、加油、停车场付费 Transportation—Taxi, vehicle tolls, gas station and parking fee

超市——便利店或大型超市，电子小票、商品选择行为 Supermarket—convenient store or hypermarket, recording shopping list and buying behavior

收银台——餐饮+影院+酒吧等，支付前后有选择行为 Cash register—Restaurant, cinema and bar

产品推广——优惠与促销、连锁折扣、电子小票 Product promotion—discount and promotion, chain discount, e-ticket

身份识别——社区、办公楼宇、工业园区、入口闸机等处门禁 Identification—Community, office building, industrial park, entrance gate, and other access controls.

共享经济产业——打印、车锁、机柜等自动售卖机 Sharing economy industry—printing industry, electronic lock of vehicle, vending machines, etc.

可提供 SDK 及 API 给合作伙伴用于各种解决方案开发。SDK and API can be provided to

partners for various solutions development.

2. 意锐小盒加强版介绍 Introduction to InsPos S

2.1 意锐小盒加强版移动支付机具 Brief Introduction

意锐小盒自助式移动支付机具用于清晰图像采集并解析，快速传送和反馈识读信息等，外观精致小巧，具超大识读窗口，读码性能强大，可快速读取微信、支付宝、银联付款码，并实现 360 度二维条码读取。本产品已通过 CE、FCC 和 ROHS 认证。

InsPos S is CE, FCC, ROHS certified hands-free mobile payment device, which is used for image acquisition, decoding, rapid information transmission and feedback, etc. With exquisite appearance and big scan window, it has powerful reading performance which is used to decode payment codes of WeChat Pay, Alipay, UnionPay, and is used for 360° 2D-code reading.

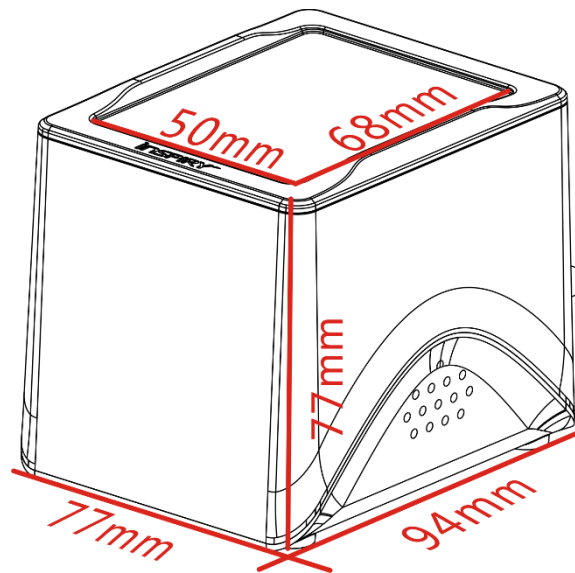

2.2 意锐小盒加强版移动支付机具特点 Distinguishing features

- 性能优良的识读平台和自主研发的软硬件集成设备。
- Excellent performed reading platform and independently developed integration equipment of software and hardware
- 可以兼容读取纸上或相同类载体上的二维码、电脑屏幕或者手机屏幕上的二维码
- Compatible with existing major 1D barcode/2D code on printed materials and electronic screens
- 能够读取微小的二维码符号及 LCD 显示器上显示出的二维码符号。

- Good skill in reading tiny 2D-code symbols and 2D-code on LCD displays
- 读码速度快，可提高工作效率。
- High decoding speed, increasing working efficiency
- 首读率达到 95%以上，超强的纠错能力。
- Over 95% first reading rate, strong error-correction ability.
- 固定距离读取识别，方便操作简单，省去学习使用设备的过程。
- Reading and identification in fixed distance, easy to operate and quick to learn to use
- 辅助光照，可适应不同光线下识别，适用性强，易用性高。
- Ancillary light, strong applicability and usability
- 可实现 360 度读取二维条码。
- 360 degree 2D-code reading

2.3 意锐小盒加强版参数 Parameters

型号 Models	PPS7200-5L
操作系统 Operation System	无操作系统限制
接口类型 Interfaces	支持串口，USB 口 Serial interface and USB interface
Wi-Fi 联网 Wi-Fi Connectivity	支持 Support
有线网络 Wired Connectivity	支持 Support
语音提示 Voice Prompt	支持 Support
解码能力 Data Capture	退款码 银联付款码 微信付款码 支付宝付款码 Refund code UnionPay payment code WeChat payment code Alipay payment code
识读方向 Reading direction	水平 360° 360° horizontally

识读速度 Reading speed	50ms, 连续识读 50ms, sequential reading
最大帧数 Max Frame rate	30FPS
工作温度 Operate Temperature	-20℃ - 60℃
工作电压 Operating Voltage	5V
额定电流 Rated Current	1A

3. 意锐小盒加强版使用说明 InsPos S Instruction

3.1 设备连接 Device Connection

3.1.1 型号 PPS7200-5L 设备连接方式 Device Connection of PPS7200-5L

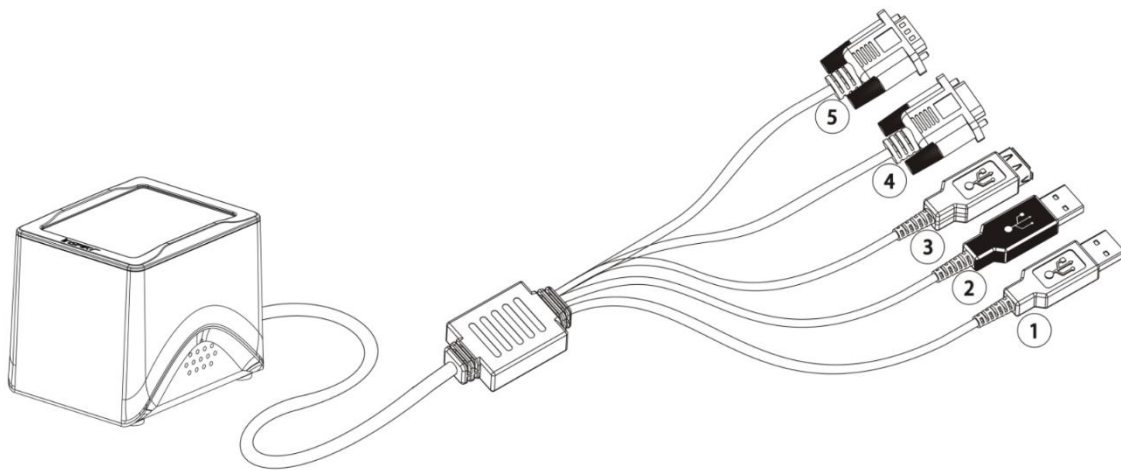

- ① USB 供电（白色）；USB cable for power supply (White)
- ② USB 供电（黑色）；USB cable for power supply (Black)
- ③ USB 母头 USB Female
- ④ 串口母头 Serial Interface Female
- ⑤ 串口公头 Serial Interface Male

A、接 USB 小键盘 Connecting the USB keyboard

③可以通过 USB hub 拓展 USB 打印机或以太网上网。扫码配置：详情见 3.2 设置配置 Wi-Fi 及打印机。It could be also extended through USB hubs to connect USB printers and to connect to Ethernet network. Configuration method by scanning code: for details, see the 3.2.

B、串口打印 Serial interface Printing

④连接收银台串口④Connecting the serial interface of Cash Register/POS;

⑤连接串口打印机⑤Connecting the serial interface of printer;

①连接电源适配器。①Connect the AC adapter.

扫码配置：详情见 3.2 设置配置 Wi-Fi 及打印机。Configuration method by scanning code: for details, see the 3.2.

C、USB 打印模式（有客显）USB interface printing(with client screen)

②连接收银台 USB ②Connecting the USB interface of Cash Register/POS;

⑤连接客户显示屏幕⑤Connecting the POS client screen ;

④连接收银台串口④Connecting the serial interface of Cash Register/POS;

③连接 USB 打印机③Connecting the USB interface of printer;

①连接电源适配器。①Connecting the AC adapter.

扫码配置：详情见 3.2 设置配置 Wi-Fi 及打印机。

Configuration method by scanning code: for details, see the 3.2.

3.2 设备配置 Wi-Fi 及打印机 Configuration method of Connecting Wi-Fi and Printer

A、用手机输入网址 <http://dm.2dupay.com/wifi-config/wifiConfig.html> 或扫描下方配置页面二维码，进入配置页面，在配置页面为 Wi-Fi，输入 Wi-Fi 名和密码，并选择打印机类型，例如：选择串口打印机，需设置正确的波特率，设置 IP 为 DHCP，点生成二维码，将生成的二维码置于设备识别窗口。此时设备会语音提示“设备配置中，请稍后”，紧接着设备自动重启。小票打印机会输出“welcome powered by Inspiry”。设备会由红光到绿光再到蓝光，最后设备白光绿光交替闪烁，此时您的设备已经联网成功。

A. Tap the URL <http://dm.2dupay.com/wifi-config/wifiConfig.html> or scan the QR-code of configuration, and enter the configuration webpage. Choose the “WIFI” from the dropdown menu, enter user name and password, and choose your printer type from the dropdown menu. For instance, if you choose serial interface printer, you need to set the right Baud rate, and set up the IP address using DHCP. Click the button “Generate QR-code” and aim the QR-code to scan window of the device. The device will prompt you “The device is under configuration, please wait a moment.”, then the device automatically will restart. The printer will print “Welcome powered by Inspiry”. The light of device will change from red to green, to blue, and finally white light and green light will blink. At this moment,

your device is connected to network successfully.



配置页面二维码 Configuration webpage

B、如何察看打印机波特率？串口打印机需要获取打印机的波特率信息，将打印机关机后，按住 feed 键不放然后开机，松开后打印机会打出自检内容，其中有波特率相关信息。

B. How to check the Baud rate of printer? The Baud rate of the parallel interface printer is needed. Power off the printer, long press the “feed” and restart the printer. The printer will print self-test information including the Baud rate.

C、如出现打印乱码，查看打印机波特率是否和服务器默认波特率、纸张大小、打印协议等是否一致，不一致登录客户系统修改，保证各项打印参数与服务器一致。

C. If the printer prints random codes, please check the consistency of Baud rate, paper size and printing protocol between the printer and server default. Make sure the print parameters are consistent with the server.

4. 搬运储藏信息 Handling and storage

4.1 储藏环境要求: Storage environment requirements:

4.1.1 环境温度 +5 摄氏度 至 +40 摄氏度

4.1.1 Environment Temperature: 5°C to 40°C

4.1.2 相对湿度 50%至 85%。保持在常温、无酸、无碱和无其他腐蚀性气体的条件下，杜绝阳光直接照射及雨水浸泡，防止重物压挤变形。

4.1.2 Relative humidity is from 50% to 85%. Keep it in normal temperature, free acid and alkali, no other corrosive gas. Prevent direct sunlight, rain water invasion, and extrusion deformation.

4.2 搬运要求: Handling requirements:

搬运或连接设备时，要轻拿、轻放、避免强烈的震动。要注意不要划伤、撞伤机壳与玻璃以免

影响美观与使用。

When handling or connecting devices, please handle it gently, avoid strong vibration. Please be careful not to scratch or collide the outer case or glass, so as not to affect the appearance and use.

5. 维护说明 Maintenance instruction

5.1、定期检查机器壳体光洁，无裂损，无变形，壳体表面无腐蚀。Please regularly check the outer case, no crack, no deformation, and no corrosion on the surface.

5.2、检查壳体固定所用的螺钉松紧度，要求无螺钉脱落。Check the tightness of the screws which are used for fixation. Make sure no screw to fall off.

5.3、检查设备的玻璃，要求表面光洁，无脏污。Check the glass of devices regularly, keep the glass clean and spotless.

5.4、设备固定的位置需避免阳光直射，且在使用时注意防磁。Prevent the fixed spots of the device from the direct sunlight, and use it in anti-magnetic environment.

5.5、设备长时间不使用时，需切断电源，且存放在干燥的环境中。When the device is not used for a long time, the power should be cut off and the device should be stored in a dry environment

6. 常见问题介绍 Comment problem introduction

6.1. 设备如何安装 Device installation

6.1.1 WiFi 网络的设备安装 Wifi network configuration

黑色 USB 口接收银台，白色 USB 口供电，黑色母头的 DB9 串口接收银机，白色公头的 DB9 串口接打印机（串口打印机），黑色 USB 母头接打印机（USB 口打印机）。

Connecting black USB interface to Cash Register/POS, connecting White USB interface to AC adapter, black DB9 female to Cash Register/POS, white DB9 male to printer (serial interface printer), black USB female to printer (USB printer).

6.1.2 有线网络的设备安装 Cable network configuration

黑色 USB 口接收银台，白色 USB 口供电，黑色母头的 DB9 串口接收银机，白色公头的 DB9 串口接打印机（串口打印机），黑色 USB 母头接 USB 以太网适配器公头端，网线接 USB 以太网适配器母头端。

Connecting black USB interface to Cash Register/POS, white USB interface to AC adapter, black DB9 female to Cash Register/POS, white DB9 male to printer (serial interface printer), black USB female to printer (USB printer), black USB female to USB male of Ethernet adapter, network cable to USB female of Ethernet adapter.

6.2. 打印机问题 Printer problems

串口打印机需要获取打印机的波特率信息，将打印机关机后，按住 feed 键不放然后开机，松开后打印机会打出自检内容，其中有波特率相关信息。

The serial interface printer needs to grab the baud rate of printer. Power off the printer, long press the “feed” and restart the printer. The printer will print self-test information including the baud rate.

打印机不出小票：检查收银系统与设备串口接线和打印机与设备串口接线。

Unable to print out tickets: Check the serial interface cable between cashier system and device or the serial interface cable between the printer and device.

无法启动：检查 USB 接线是否正常，或者更换 USB 电源接口。

Unable to start: check the USB cable or change the USB power interface.

打印乱码，查看打印机波特率是否和服务器默认波特率、纸张大小、打印协议等是否一致，不一致登录客户系统修改，保证各项打印参数与服务器一致。

If the printer prints random codes, please check the consistency of baud rate, paper size and printing protocol between the printer and server default. Make sure the print parameters are consistent with the server.

6.3. 联网问题 Networking problems

配置好 WIFI /有线网络后，设备联网成功时，会每隔两秒钟闪一次绿色。联网失败时，会每隔两秒闪一次红色。用户可一次判断联网情况。

After the configuration of Wi-Fi/cable network, if the device connects to server successfully, the green light of device will flash every two seconds. If the device connects to server unsuccessfully, the red light will flash every two seconds. Users could be easy to judge the situation of connection, according to the lights.

无法连接网络：检查无线网络或者网线连接是否正常。重新扫码配置设备网络，自动重启设备。

Unable to connect to network: check whether the wireless network or network connection is normal. Otherwise, re-scan the QR-code to configure the network and restart the device.

6.4. LED 灯光指示 Led light indication

白光：设备常态 White light: normal

闪烁红光：网络未连接 Flashing red light: device is disconnected to network

闪烁绿光：网络已连接 Flashing green light: device is connected to network

闪烁蓝光：串口有数据传输 Flashing blue light: serial spot has data transmission

常亮品红色：设备正在升级 Magenta light keeps on: the device is being updated

6.5. 程序升级 device update

设备程序升级时，灯的颜色会一直是品红色，此时注意一定不要拔掉电源，否则会升级失败，返厂才能进行修复。

When the program of device is being updated, the magenta light will be kept on. Don't turn off the device or cut the power, otherwise, the update will fail and the device will need to return to factory repair.

7. 机器的报废处理 Device disposal

报废处理：拆除外壳，卸下电路板。电路板的报废应符合当地电子产品的回收报废处理的法律规定

Device disposal: remove the outer case and circuit board. The disposal of circuit board scrap should comply with the local laws and regulations.

8. 售后服务 After-sales service

请保管好您购买的有效产品附件，在您需要帮助的时候请出示这些未经涂改的原始单据，否则保修承诺将失效。您的保修服务仅限于正常使用下有效。依据产品使用说明书使用，且勿自行拆装，连接不适当的配件，未经我公司许可的维修和改装；由于不正当操作等人为原因造成的外壳严重变形、破损；镜头破损、划痕的；CMOS 传感器烧毁或有明显划痕的；不正当操作造成的 PCB 板烧毁等一切人为损坏；以上将不在保修范围之内。

Please keep all your accessories of the product, and show the original document without alteration when you need the technical support, or your warranty will be voided. The warranty is only limited to the problems arising in the normal use condition. Please operate according to the instruction, do not disassemble, use inappropriate accessories. Without

our permission, any maintenance and modification; deformation, serious damage and breakage due to improper operation; lens scratches; CMOS sensor burned or obvious scratches; PCB board burned; and all the artificial damage are beyond guarantee range.

感谢您使用意锐小盒读取器，如果您对本指南内容有不明了或任何建议之处，可通过以下列方式与我们联络。我们会更用心地继续为您服务，也期待您一直与我们保持互动，鞭策我们走更远的路！

Thank you for using the hands-free code-reading devices. If you have any questions or suggestions about this instruction, please contact us in the following way. We will continue to serve you more diligently, and look forward to your continuous interaction with us and further encouragement.

若是技术或软件、硬件方面的问题，您可以进入 <http://www.inspiry.cn> 参考产品相关讯息。或电话至北京意锐新创科技有限公司的官方电话，由我们的客服工程师为您解答。

If you have any technical, software or hardware problem, you could refer to the related information on <https://www.inspiry.cn> or call the customer service number, our engineers are glad to answer your questions.

地址：北京市海淀区上地西路6号1幢D5

Address: 5th Floor, D Building, No.6, Shangdi West Road, Haidian District, Beijing, China

网址 Website: <http://www.inspiry.cn>







电话 Hotline: +86-400-670-4880

9. 意锐小盒加强版参数 Parameters

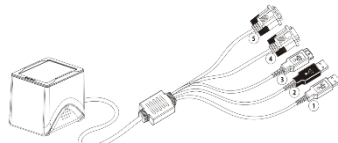
型号 Models	PPS7200-5L	PPS7200-4L	PPS7200-2L	PPS333 (同 PPS7200) PPS333 equals PPS7200 PPS333-5L(同 equals)PPS7200-5L PPS333-4L(同 equals) PPS7200-4L PPS333-2L(同 equals) PPS7200-2L	PPS331 (同 PPS7100) PPS331 equals PPS7100 PPS331-5L(同 equals)PPS7100-5L PPS331-4L(同 equals) PPS7100-4L PPS331-2L(同 equals) PPS7100-2L
操作系统 Operation System	无操作系统限制 No operating system restrictions	无操作系统限制 No operating system restrictions	无操作系统限制 No operating system restrictions	无操作系统限制 No operating system restrictions	无操作系统限制 No operating system restrictions
接口类型 Interfaces	支持串口, USB 口 Serial interface and USB interface	支持串口, USB 口 Serial interface and USB interface	支持 USB 口 USB interface	PPS333-5L(同 equals)PPS7200-5L PPS333-4L(同 equals) PPS7200-4L PPS333-2L(同 equals) PPS7200-2L	支持串口, USB 口 Serial interface and USB interface PPS331-5L: 支持串口, USB 口 Serial interface and USB interface PPS331-4L: 支持串口, USB 口 Serial interface and USB interface PPS331-2L: 支持 USB 口 USB interface

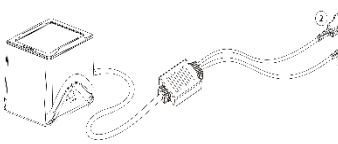
Wi-Fi 联网 Wi-Fi Connectivity	支持 Support	支持 Support	支持 Support	支持 Support	支持 Support
有线网络 Wired Connectivity	支持 Support	支持 Support	支持 Support	支持 Support	支持 Support
语音提示 Voice Prompt	支持 Support	支持 Support	支持 Support	支持 Support	支持 Support
解码能力 Data Capture	退款码 银联付款码 微信付款码 支付宝付款码 Refund code UnionPay payment code WeChat payment code Alipay payment code	退款码 银联付款码 微信付款码 支付宝付款码 Refund code UnionPay payment code WeChat payment code Alipay payment code	退款码 银联付款码 微信付款码 支付宝付款码 Refund code UnionPay payment code WeChat payment code Alipay payment code	退款码 银联付款码 微信付款码 支付宝付款码 Refund code UnionPay payment code WeChat payment code Alipay payment code	退款码 银联付款码 微信付款码 支付宝付款码 Refund code UnionPay payment code WeChat payment code Alipay payment code
识读方向 Reading direction	水平 360° 360° horizontally	水平 360° 360° horizontally	水平 360° 360° horizontally	水平 360° 360° horizontally	水平 360° 360° horizontally
识读速度 Reading speed	50ms, 连续识读 50ms, sequential reading	50ms, 连续识读 50ms, sequential reading	50ms, 连续识读 50ms, sequential reading	50ms, 连续识读 50ms, sequential reading	50ms, 连续识读 50ms, sequential reading
最大帧数 Max Frame rate	30FPS	30FPS	30FPS	30FPS	30FPS
工作温度 Operate Temperature	-20℃ - 60℃	-20℃ - 60℃	-20℃ - 60℃	-20℃ - 60℃	-20℃ - 60℃

工作电压 Operating voltage	5V	5V	5V	5V	5V
额定电流 Rated current	1A	1A	1A	1A	1A
外壳 Plastic shell	P02 	P02 	P02 	P02 	P01 
灯板 Light board	PCB:FPC 材质 PCB:FPC Material	PCB:FPC 材质 PCB:FPC Material	PCB:FPC 材质 PCB:FPC Material	PCB:FPC 材质 PCB:FPC Material	PCB: FR-4
数据线 Data cable	一拖五数据线 Five in One	一拖四数据线 Four in One	一拖二数据线 Two in One	5L(一拖五数据线 Five in One) 4L(一拖四数据线 Four in One) 2L(一拖二数据线 Two in One)	5L(一拖五数据线 Five in One) 4L(一拖四数据线 Four in One) 2L(一拖二数据线 Two in One)

<p>示图说明 Illustration description</p>	 <p>⑥ USB 供电（白色）； USB cable for power supply(White)</p> <p>⑦ USB 供电（黑色）； USB cable for power supply(Black)</p> <p>⑧ USB 母头 USB Female</p> <p>⑨ 串口母头 Serial Interface Female</p> <p>⑩ 串口公头 Serial Interface Male</p>	 <p>① USB 供电（白色）； USB cable for power supply(White)</p> <p>② USB 母头 USB Female</p> <p>③ 串口母头 Serial Interface Female</p> <p>④ 串口公头 Serial Interface Male</p>	 <p>① USB 供电；USB cable for power supply</p> <p>② USB 母头： USB Female,</p>	<p>PPS333-5L(同 equals)PPS7200-5L PPS333-4L(同 equals) PPS7200-4L PPS333-2L(同 equals) PPS7200-2L</p>	 <p>PPS331-2L</p> <p>① USB 供电；USB cable for power supply</p> <p>② USB 母头： USB Female,</p>  <p>PPS331-4L</p> <p>① USB 供电(白色);USB cable for power supply(White)</p> <p>② USB 母头 USB Female</p> <p>③ 串口母头 Serial Interface Female</p> <p>④ 串口公头 Serial Interface Male</p>  <p>PPS331-5L</p>
--	--	---	---	---	---

					<ul style="list-style-type: none">① USB 供电(白色);USB cable for power supply (White)② USB 供电(黑色);USB cable for power supply (Black)③ USB 母头 USB Female④ 串口母头 Serial Interface Female⑤ 串口公头 Serial Interface Male
--	--	--	--	--	---