

MODEL BE-900MHZ

40 CHANNEL CORDLESS HEADSET TELEPHONE

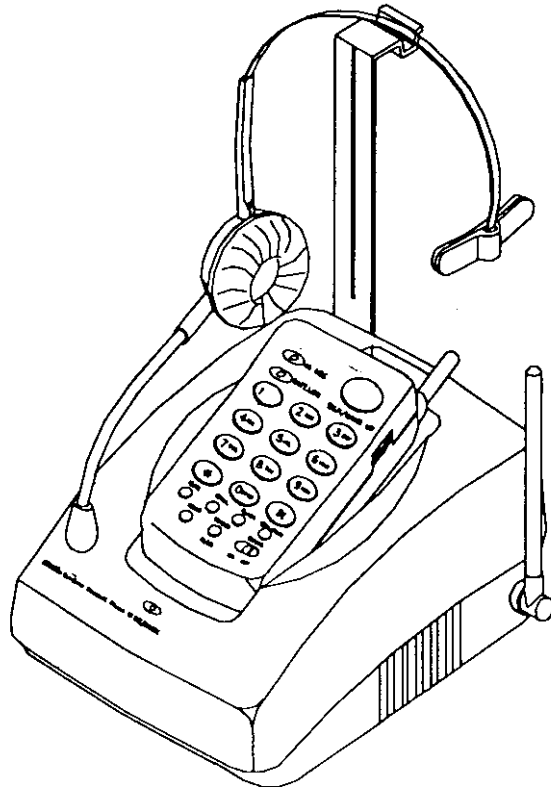

OWNER'S MANUAL

Please read this instruction manual carefully.

CONTENTS

Important Safety Information	4
Battery Cautionary Instructions	5
Features	6
Installation	7
Selecting a Location	7
Getting Started	7
Connecting the Telephone	7
Installing the Battery Pack.....	9
Connecting the Headset.....	10
Operation	11
Charging the Battery Pack	11
Adjusting the Headset	12
Setting the Tone/Pulse Switch.....	14
Using the Belt Clip.....	14
Making and Receiving Calls	15
Changing Channels.....	16
Setting the Volume	16
Setting the Ringer Hi/Lo Switch.....	17
Using the Redial/Pause Button	17
Using the Mute Button	18
Using the Flash button	18
Using Tone Services on a Pulse Line	19
Storing a Number in Memory.....	19
Entering a Pause in a Stored number	20
Dialing a Stored number.....	21
Chain Dialing numbers	21
Care and Maintenance	22
Replacing the Battery Pack.....	22
Service Information	24
Troubleshooting.....	24
FCC Requirements	25
Warranty Information	26

IMPORTANT SAFETY INSTRUCTIONS

When using your telephone equipment, basic safety precautions should always be followed to reduce the risk of fire, electrical shock, and injury to persons including the following:

1. Read and understand all instructions.
2. Follow all warnings and instructions marked on the product.
3. Unplug this product from the wall outlet before cleaning. Do not use liquid cleaners, or aerosol cleaners. Use a damp cloth for cleaning. If necessary, use a mild soap.
4. Do not use this product near water, for example near a bath tub, wash bowl, kitchen sink, or laundry tub, in a wet basement, or near a swimming pool.
5. Do not place this product on an unstable cart, stand or table. The product may fall, causing serious damage to the product.
6. This product should be operated only from the type of power source indicated on the marking label. If you are not sure of the type of power supply to your home, consult your dealer or local power company.
7. Do not allow anything to rest on the telephone line cord. Do not locate this product where the cord will be abused by persons walking on it.
8. Never push objects of any kind into this product through the cabinet slots as they may touch dangerous voltage points or short out parts that could result in a risk of fire or electric shock. Never spill liquid of any kind on the product.
9. To reduce the risk of electric shock, do not disassemble this product, but take it to a qualified serviceman when some service or repair work is required. Opening or removing covers may expose you to dangerous voltages or other risks. Incorrect re-assembly can cause electric shock when the appliance is subsequently used.
10. Unplug this product from the wall outlet and refer to qualified service personnel under the following conditions:
 - a. When the power supply cord or plug is damaged or frayed.
 - b. If liquid has been spilled into the product.
 - c. If the product has been exposed to rain or water.
 - d. If the product does not operate normally by following the operating instructions. Adjust only those controls, that are covered by the operating instructions. Improper adjustment of other controls may result in damage and will often require extensive work by a qualified technician to restore the product to normal operation.
 - e. If the product has been dropped or the cabinet has been damaged.
 - f. If the product exhibits a distinct change in performance.
11. Avoid using a telephone (other than a cordless type) during an electrical storm. There may be a remote risk of electrical shock from lightning.
12. Do not overload wall outlets and extension cords as this can result in the risk of fire or electrical shock.
13. Do not use the telephone to report a gas leak in the vicinity of the leak.

SAVE THESE INSTRUCTIONS

BATTERY CAUTIONARY INSTRUCTIONS

CAUTION: To Reduce the Risk of Fire or Injury to Persons, Read and Follow these Instructions.

1. Use only the replacement battery pack of the required size and type: 3.6 volt @ 600 mAh metal hydride battery.
2. Do not dispose of the batteries in a fire. The cell may explode. Check with local codes or possible special disposal instructions.
3. Do not open or mutilate the battery. Released electrolyte is corrosive and may cause damage to the eyes or skin. It may be toxic if swallowed.
4. Exercise care in handling batteries in order not to short the battery with conductors such as rings, bracelets, keys. The battery or conductor may overheat and cause burns.
5. Do not attempt to recharge the batteries provided with or identified for use with this product by heating them. The battery may leak corrosive electrolyte or may explode.
6. Do not attempt to rejuvenate the batteries provided with or identified for use with this product by heating them. Sudden release of the batteries electrolyte may occur causing burns or irritation to eyes or skin.
7. All batteries should be replaced at the same time. Mixing fresh and discharged batteries could increase internal cell pressure and rupture the discharged batteries.
8. When inserting batteries into this product, the proper polarity or direction must be observed. Reverse insertion of batteries can cause charging, and that may result in leakage or explosion.
9. Remove the battery from this product if the product will not be used for a long period of time (several months or more) since during this time the battery could leak in the product.
10. Discard dead batteries as soon as possible since dead batteries are more likely to leak in a product.
11. Do not store this product, or the battery provided with or identified for use with this product, in high temperature areas. Batteries that are stored in a freezer or refrigerator for the purpose of extending shelf life should be protected from condensation during storage and defrosting. Batteries should be stabilized at room temperature prior to use after cold storage.

CAUTION ▲ : Any changes or modifications in the construction of this device which is not expressly approved by the party responsible for compliance could void the user's authority to operate this equipment.

FEATURES

The BE-900MHZ cordless headset telephone is designed to provide the convenience of high quality portable telephone communication. The BE-900MHZ telephone consists of a cordless remote keypad unit and a base unit. The base's space saving, upright design makes it ideal in areas where space is limited.

The remote keypad allows the user to make or receive calls away from the base unit. A lightweight headset connected to the remote keypad provides hands free operation, permitting the user to do other things while talking. The BE-900MHZ cordless telephone offers the following features:

- Comfortable, lightweight headset with adjustable boom microphone.
- Advanced Super CCT circuitry provides sound clarity comparable to that of a corded phone.
- Security Access-Protection Code - prevents other cordless phone users from using your phone line while the remote keypad is off the cradle.
- Last Number Redial button redials the last phone number dialed.
- Auto Scan feature automatically selects a clear channel when you pick up the phone.
- Mute button turns off the headset microphone so the other party cannot hear you.
- Memory button allows user to store and access 10 telephone numbers in Speed-Dial memory for easy dialing.
- Channel button allows user to select one of 40 available channels.
- Flash button for use with special telephone company services.
- TONE/PULSE switch allows the user to select either type of service.
- Ringer HI/LO switch allows the user to select high or low ringer volume.
- Ringer ON/OFF switch allows user to turn off the ringer.
- Hinged Belt Clip allows the user to carry the remote keypad on belt for easy access.
- 200 foot range depending upon surroundings.
- Receive level Volume Control.
- Hearing-Aid Compatible.
- Supplied with a Class 2 power adapter rated at 9 VDC @ 200ma, center positive.

INSTALLATION

SELECTING A LOCATION

Install the BE-900MHZ base unit in a location that is near an AC power outlet and a modular telephone line jack. The base's location effects the phone's range. Try several locations to see which provides the best performance.

Select a location that is away from, electrical machinery, electrical appliances, metal walls, filing cabinets, wireless intercoms, security alarms, and room monitors.

GETTING STARTED

Unpack the unit and check to be sure you have all the items that come with your cordless telephone.

- Telephone base
- Remote keypad
- Headset
- 3.6 Volt battery
- Telephone line cord

CONNECTING THE TELEPHONE

Follow these steps to connect the BE-900MHZ base unit to a source of AC power and to the telephone line. (See Figure 1)

1. Plug one end of the supplied modular telephone line cord into the **TEL. LINE** jack in the rear of the base unit.
2. Plug the remaining end of the telephone line cord into an existing modular telephone line jack.
3. Place the base unit antenna in a vertical position.
4. Put the headset holder into the slot on the back of the base and slide it into place.
5. Insert the power adapter cord plug into the **DC 9V** jack located in the rear of the base unit.
6. Plug the adapter into an existing AC power outlet.

INSTALLATION - continued

Figure 1

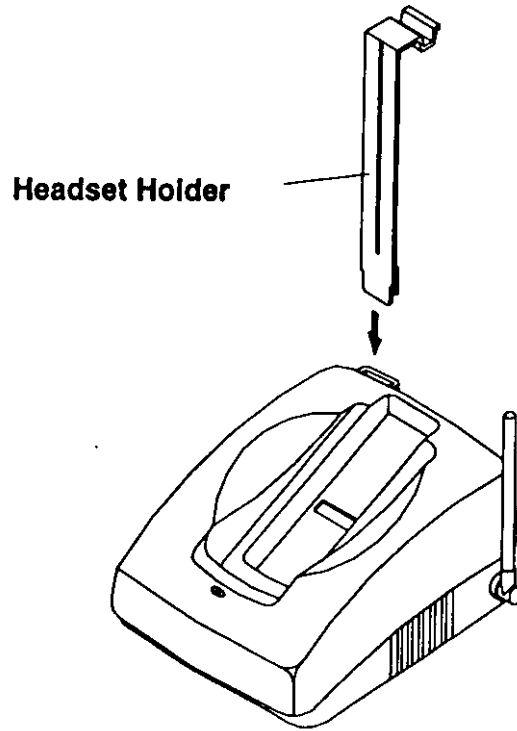
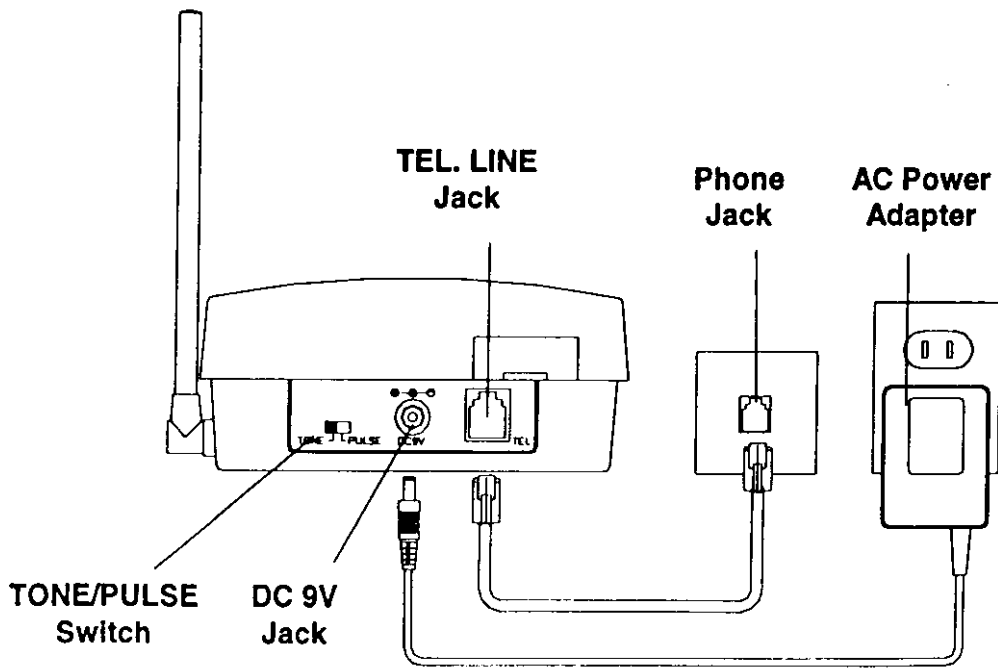

FIGURE 2



INSTALLATION - continued

INSTALLING THE BATTERY PACK

Your BE-900MHZ telephone comes with a rechargeable Metal Hydrogen 3.6V @600mA battery pack in the remote keypad unit. You must install and charge the battery pack for at least 15 hours before you use it. Follow these steps to install the battery pack.

FIGURE 3

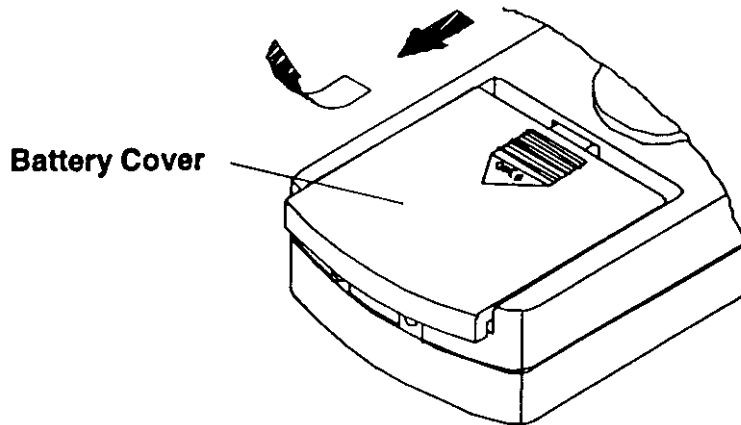

1. Remove the battery compartment cover on the remote keypad. Push the top of the battery cover in the direction of the arrow. (See Figure 3)
2. Gently push the battery pack connector onto the connector pins inside the battery compartment. (See Figure 4)
3. Place the battery pack into the battery compartment, and replace the battery cover.

FIGURE 4

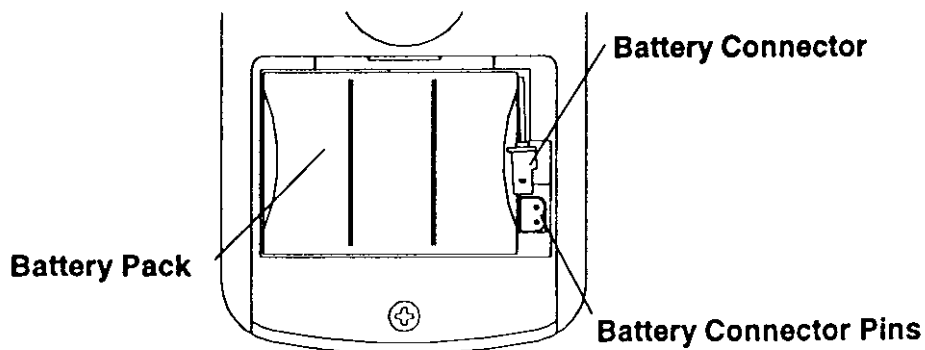

INSTALLATION - continued

CONNECTING THE HEADSET

Insert the mini stereo plug from the headset cord into the headphone jack on the top of the remote keypad.

1. Slip the headset cord under the strain relief clip located on the remote keypad. (See Figure 5)

Figure 5

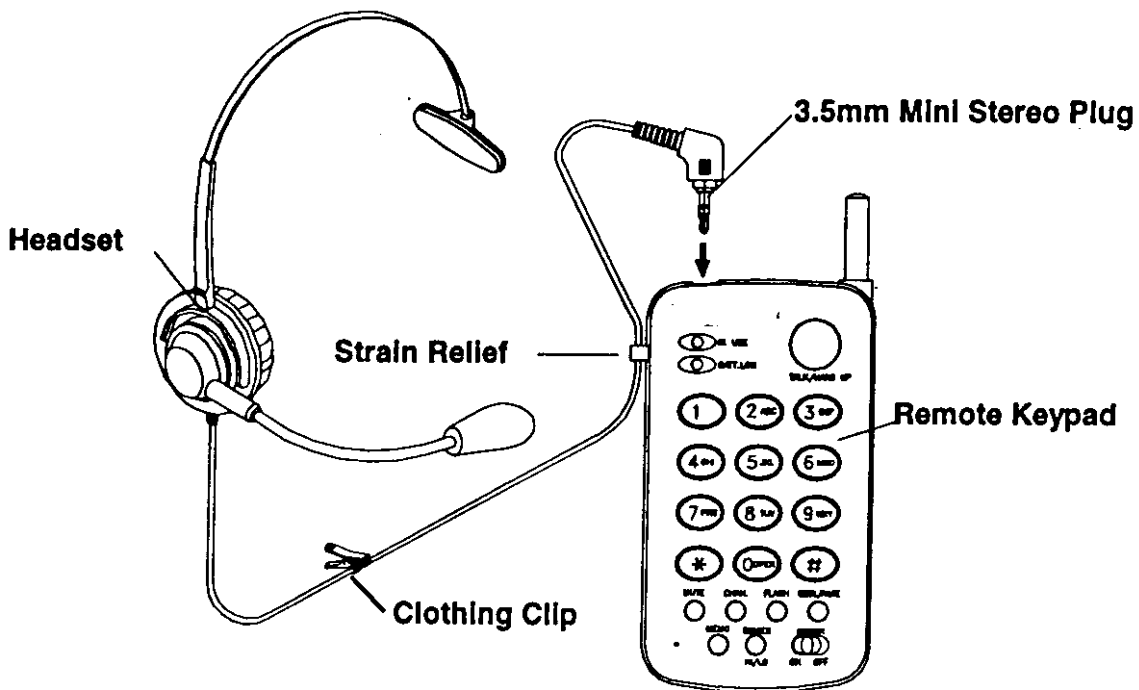

CHARGING THE BATTERY PACK

Place the remote keypad unit into the top of the base unit.

1. The **IN USE/CHARGE** indicator will light if the remote keypad is inserted in the base unit. (See Figure 6)
2. If the **IN USE/CHARGE** indicator does not light when the remote keypad is in the base, check that the battery pack and AC adapter are correctly connected.

OPERATION

Figure 6

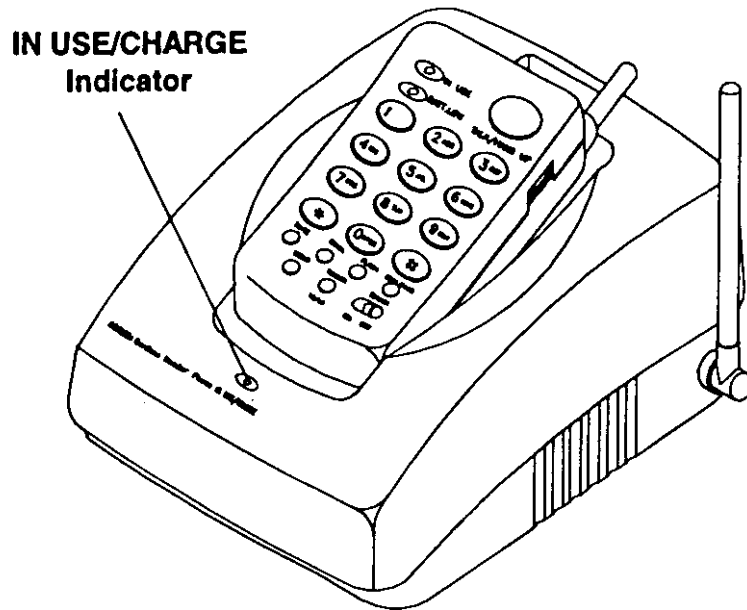
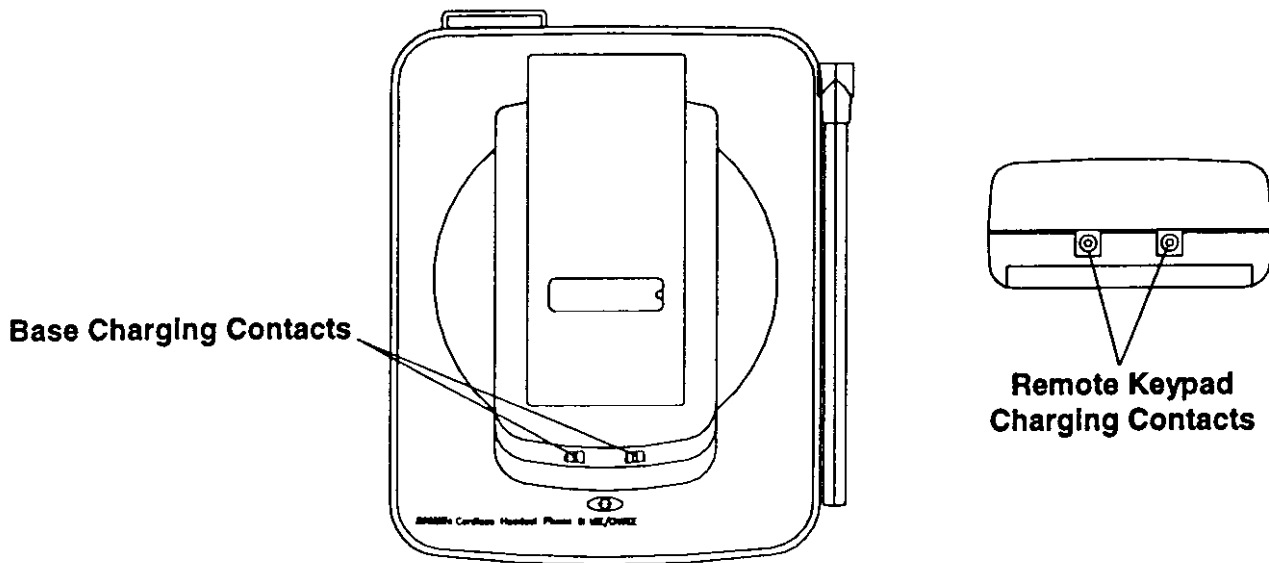

Figure 7



OPERATION - continued

When you first use the phone after charging or recharging the battery pack, the phone might not work and you might hear error tones.

- If you hear the error tones, return the remote keypad to the cradle for at least 5 seconds to reset the security access-protection code.
- Recharge the battery pack when the **BATT. LOW** indicator on the remote keypad lights.
- If the battery pack power is too low, the **BATT. LOW** indicator on the remote keypad will not light.
- If the **IN USE/CHARGE** indicator does not light when you place the keypad in the base unit, check the charging contacts on the remote keypad and base. If the contacts are dirty or tarnished, clean them with a pencil eraser. (See Figure 7)
- About once a month, fully discharge the battery pack by keeping the remote keypad off the base unit until the **BATT. LOW** indicator lights. This will maintain the battery pack's ability to fully recharge.

ADJUSTING THE HEADSET

Put on the headset, and adjust the band until it rests with almost no pressure on your ear and the top of your head. (See Figures 8 and 9)

1. If the headset is too loose, remove it and gently push the headset band inward slightly to tighten it. If the headset is tight, gently pull the headset band out to loosen it.
2. The microphone boom can be swiveled to position the headset on either your right or left ear.
3. Use one hand to hold the headset in place. Adjust the microphone boom until it is about 1 inch from your mouth. Do not twist the mic on the end of the boom as this may damage the internal wiring.
4. Use the clothing the clip to attach the headset cord to your lapel or collar and out of your way.
5. Leave enough slack in the headset cord so that you can move your head freely.
6. When you are not using the headset, always place it on the base unit headset holder.

OPERATION - continued

Figure 8

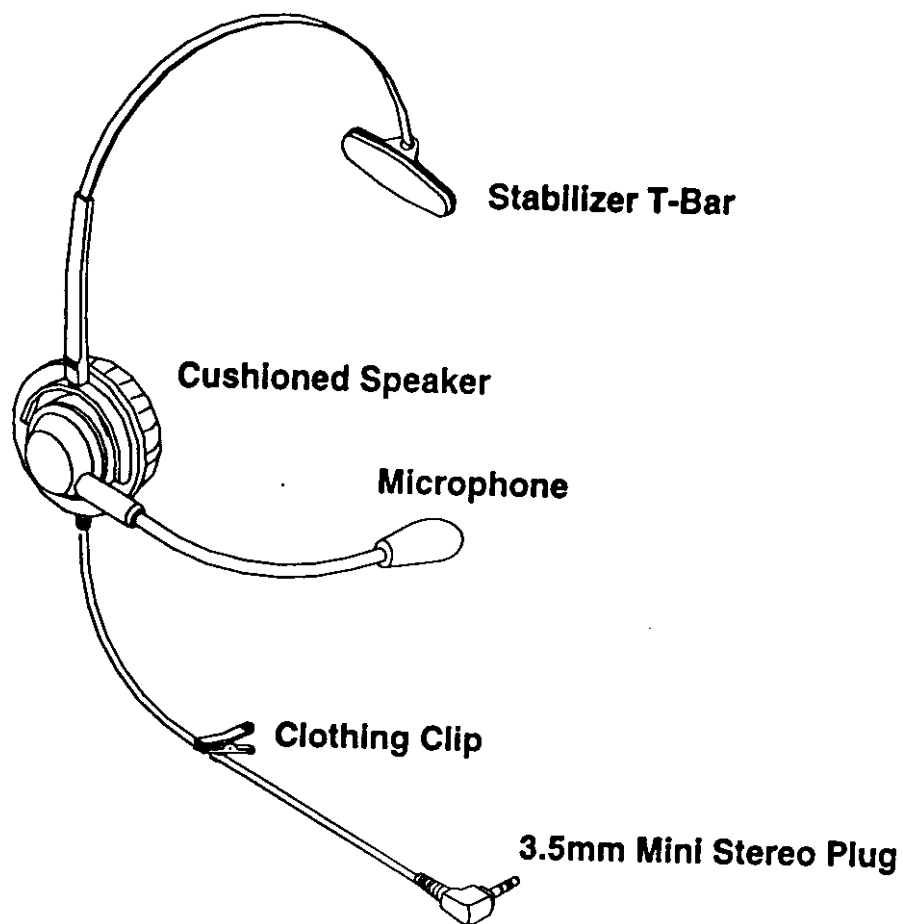
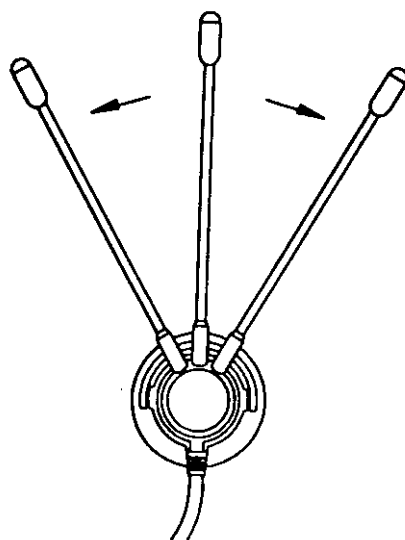

Figure 9



OPERATION - continued

SETTING THE TONE/PULSE SWITCH

Set the **TONE-PULSE** switch located at the rear of the base unit for the type of service you have. If you are not sure of which type service you have, do the following test after charging the battery. (See Figure 10)

FIGURE 10

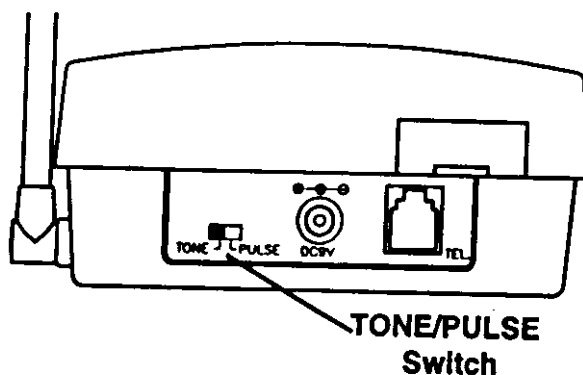

1. Set the **TONE-PULSE** switch to **TONE** position.
2. Remove the keypad from the base unit. Press the **TALK/HANG UP** button and listen for dial tone.
3. Press any dialing button other than 0. If dial tone stops, you have touch-tone service. Leave the **TONE-PULSE** switch set to **TONE** position.
4. If dial tone continues, you have pulse service. Set the **TONE-PULSE** switch to **PULSE** position.

USING THE BELT CLIP

Use the belt clip to hang the keypad on your belt or waistband for convenient hands free carrying.

1. The belt clip is designed to rotate 360° and can be used in an up or down position.
2. For hands free carrying, you can also put the compact remote keypad into your pocket.

OPERATION - continued

MAKING AND RECEIVING CALLS

Before using your cordless telephone, put the headset on and adjust it as needed.

1. Set the **RINGER** switch on the remote keypad to the **ON** position.
2. To make a call, press the **TALK/HANG UP** button, the **IN-USE** indicator will light.
3. When you hear dial tone, enter the number you want to call. (See Figure 11)

FIGURE 11

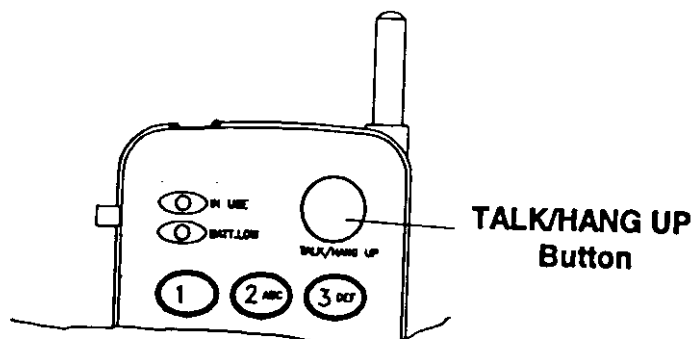

4. To disconnect a call, press the **TALK/HANG UP** button or place the remote keypad on the base.
5. To answer a call when the keypad is in the base, pick up the remote keypad. The **IN USE** indicator will light.
6. To answer a call when the keypad is not on the base, press the **TALK/HANG UP** button, the **IN USE** indicator will light.
7. To conserve battery power, set the **RINGER** switch to the **OFF** position when the remote keypad is away from the base. When you hear another phone on the same line ring, press the **TALK/HANG UP** button to answer the call.
8. When you press a button on the remote keypad, a short tone will be heard indicating that the base unit has accepted the command.
9. Three tones indicate that you have pressed a button in error, you are out of range, or there is too much interference.
10. If there is severe interference, move closer to the base before you press any key. If interference is severe, the keypad might lose communication with the base and the call might be disconnected. This does not happen often, but if it does, return the keypad to the cradle for a few seconds.

OPERATION - continued

CHANGING CHANNELS

Your cordless headset telephone has an auto scan feature that automatically selects a clear channel when you press the **TALK/HANG UP** button. If you experience interference during a call, press the **CHAN.** button to switch to another channel until you have good reception. (See Figure 12)

FIGURE 12

CHAN.
Button

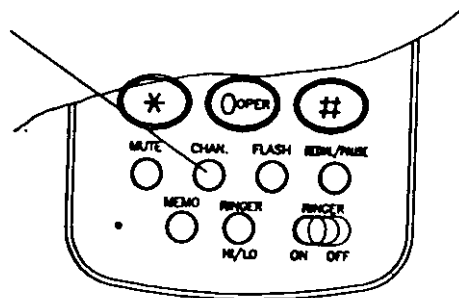

SETTING THE VOLUME

The **VOLUME** control allows you to adjust the sound level that you hear through the headset. This is especially useful for people who have trouble hearing, or are in an especially noisy area like a kitchen or workshop.

1. Set the **VOLUME** control on the side of the remote keypad to a comfortable listening level. (See Figure 13)

FIGURE 13

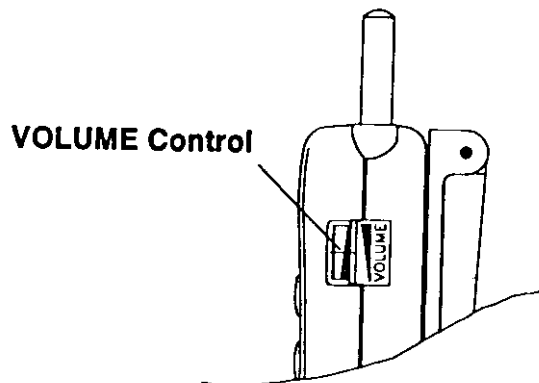

OPERATION - continued

SETTING THE RINGER HI/LO SWITCH

The **RINGER HI/LO** button lets you adjust the ringer volume that you hear through the remote keypad. (See Figure 14)

1. When you press and hold the **RINGER HI/LO** button for 1 second, the ringer volume will change from high to low or low to high when the **IN USE** indicator on remote keypad is off.
2. The **RINGER HI/LO** button does not work when you are talking or when the telephone line is ringing.

FIGURE 14

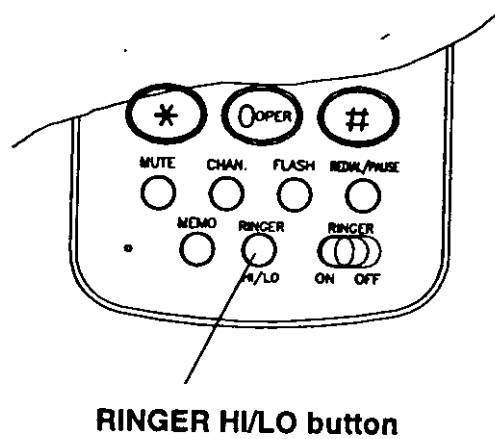

USING THE REDIAL/PAUSE BUTTON

To quickly redial the last number dialed, press the **TALK** button.

1. When dial tone is heard, press the **REDIAL/PAUSE** button. (See Figure 15)

Figure 15

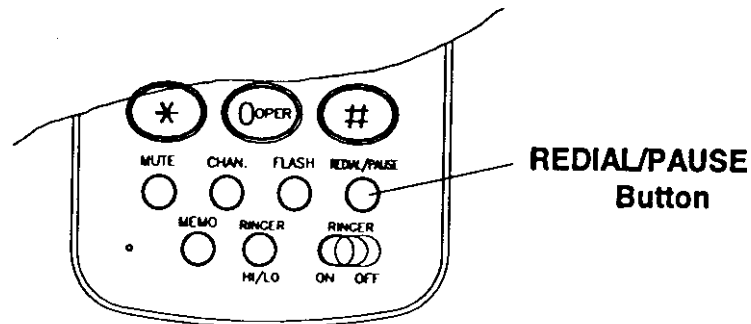

OPERATION - continued

2. The redial memory can also switch from pulse to tone dialing and can store **PAUSE** entries.

USING THE MUTE BUTTON

The **MUTE** button mutes the headset microphone so the other party cannot hear you when you are talking to someone else in the room.

1. Press and hold the **MUTE** button located on remote keypad. Release the **MUTE** button to resume your phone conversation. (See Figure 16)
2. When the **MUTE** button is engaged, you can still hear other party, this is normal.

FIGURE 16

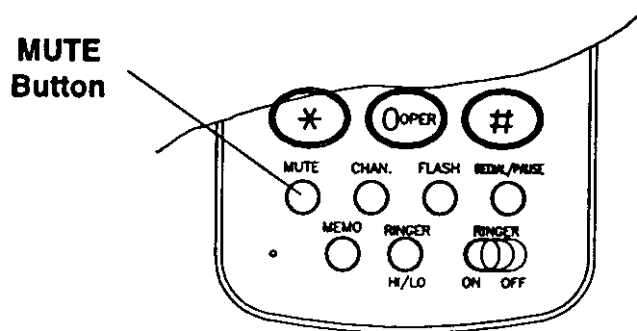

USING THE FLASH BUTTON

Pressing the **FLASH** button provides the electronic equivalent of momentarily pressing the hook switch which is used for special telephone services such as Call Waiting.

1. For example, if you have Call Waiting, you can put the present call on hold and answer a second call by pressing the **FLASH** button. (See Figure 17)
2. Press the **FLASH** button again to return to the original call.
3. If you do not have any special telephone services, pressing the **FLASH** button may disconnect your call.
4. The redial memory does not store the **FLASH** entry or the digits you press after pressing the **FLASH** button.

OPERATION - continued

Figure 17

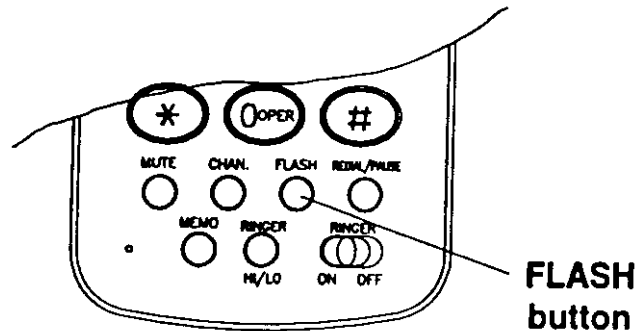

USING TONE SERVICES ON A PULSE LINE

Some special phone services, such as bank-by-phone, require tone signals. If you have pulse service, you can still use these special tone services.

1. Dial the service's main number.
2. Press the # (pound) button at the point that tone signals are required, then dial the additional digits of the number. The phone will send these numbers as tone signals.
3. The phone automatically resets to pulse mode when you hang up.

STORING A NUMBER IN MEMORY

The BE-900MHZ speed dial memory can store up to 10 phone numbers, containing a maximum of 16 digits. The 0 through 9 buttons on the keypad recall and dial the phone numbers stored in memory. When storing numbers for special services such as alternate long distance or bank-by-phone, store the service's main phone number in one memory location and numbers for additional information in other locations. Follow these steps to store phone numbers in memory.

1. With the **IN-USE** indicator off, press the **MEMO** button. (See Figure 18)
2. Enter the phone number you want to store, then press the **MEMO** button again.
3. Press the desired keypad dialing key (0-9). This will be the memory location number for the phone number you are storing.
4. A long beep will sound confirming that the phone number has been stored.
5. To change a number stored in memory, simply store a new number in that memory location.

OPERATION - continued

1. If you receive a call while you are storing a number in memory, press the **TALK/HANG UP** button to answer the call. After the call is finished, begin again at step 1.

Figure 18

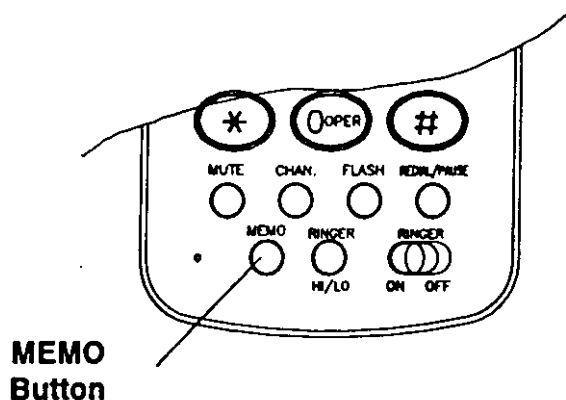

ENTERING A PAUSE IN A STORED NUMBER

In some telephone systems, you must dial an access code (9, for example) and wait for a second dial tone before you can dial an outside number.

1. To enter a 3-second pause, press the **REDIAL/PAUSE** button at the appropriate point that you want to store a number in memory. To enter another 3-second pause, press the **REDIAL/PAUSE** button again. (See Figure 19)

Figure 19

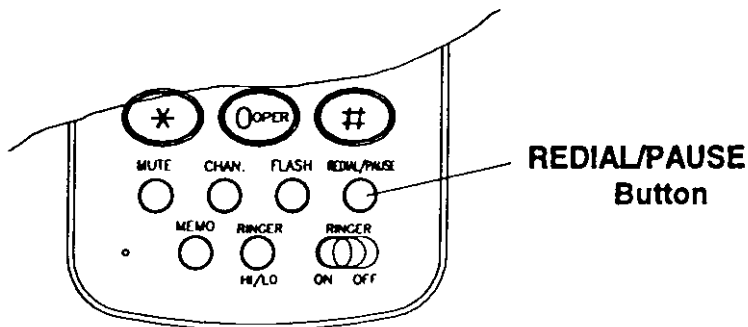

OPERATION - continued

DIALING A STORED NUMBER

Follow these steps to dial a stored number.

1. Press the **TALK/HANG UP** button.
2. When dial tone is heard, press the **MEMO** button, then press the desired (0-9) memory location button.
3. The stored number you have selected will be automatically dialed.

CHAIN DIALING NUMBERS

You can dial several telephone numbers stored in different memory locations during one phone call. This is useful when you must dial more than one number in memory to complete a call, such as frequent calls using an independent long distance service.

1. When you hear dial tone, press the **MEMO** button, then the memory location button that contains the service's main number.
2. When the service's main number answers, press the **MEMO** button, then the memory location button to dial the additional information.

CARE AND MAINTENANCE

REPLACING THE BATTERY PACK

Replace the remote keypad battery pack if it does not hold a charge for more than 2 hours after an overnight charge.

1. Replace the old battery pack with a new 3.6V @600mAh metal hydride battery pack.
2. The replacement battery pack must have a connector that fits the connector pins located in the remote keypad battery compartment.
3. An equivalent battery pack may be available at your local electronics store.
4. Replacement battery packs can be obtained directly from TT Systems Corporation. If you desire to purchase an exact replacement battery pack, an order form can be found on the rear cover of this manual.
5. **Caution:** Please refer to and read the **BATTERY CAUTIONARY INSTRUCTIONS** found on Page 5 of this manual prior to replacing the battery pack.
6. **Important:** Your telephone contains a rechargeable metal hydride battery pack. At the end of the battery pack's useful life, it must be recycled or disposed of properly. Contact your local, county, or state hazardous waste management authorities for information on recycling or disposal programs in your area.
7. Install the new battery pack as described in "Installing the Battery Pack" on Page 9 and "Charging the Battery Pack" on Page 10 of this manual.
8. **Important:** The new battery pack must be charged for about 15 hours before you use it the first time.
9. The maximum standby time for a freshly charged battery pack is approximately 7 days. The maximum talk time is approximately 6 hours.

CARE AND MAINTENANCE - continued

The BE-900MHZ has been designed to give years of trouble free service. To help insure its longevity, please read the following maintenance instructions:

- Keep the BE-900MHZ dry. If it gets wet, first unplug the AC adapter then wipe the unit dry immediately. Liquids can contain minerals that can corrode electronic circuits.
- Use and store the BE-900MHZ only in normal temperature environments. High temperatures can shorten the life of electronic components and distort or melt its plastic parts.
- Keep the BE-900MHZ away from dust and dirt, which can cause premature product failure.
- Handle the BE-900MHZ gently and carefully. Dropping it can cause serious damage to circuitry, or plastic case, which may result in causing it to malfunction.
- The BE-900MHZ has built-in surge protection circuits that meet or exceed FCC requirements. However, an incident such as a lightning strike at or near the telephone lines, could cause serious damage.
- If the BE-900MHZ is installed in an area with frequent / or severe electrical storm, it is suggested that the telephone be disconnected during these storms or that additional surge suppression equipment be added to the installation.
- It is the responsibility of users requiring service to report the need for service to TT Systems Corporation. They will make the necessary arrangements for repair or replacement.
- Should you have any questions about the operation of the BE-900MHZ, please call 1-914-968-2100, between the hours of 9:00 A.M. and 4:30 P.M. eastern time. Or you may contact TT Systems Corporation for technical assistance via our Internet Web-site: <http://www.tech@ttsystems.com>.

TROUBLESHOOTING

We do not expect you to have any problem with your phone, but if you do, the following suggestions may help.

SYMPTOM	SUGGESTION
The phone does not work.	Make sure that the RINGER ON/OFF switch is in the ON position.
	Ensure the phone's telephone cord and the AC adapter are installed correctly.
	Recharge the keypad's battery pack. If the battery power is too low, the BATT. LOW indicator will not light.
	Reset the security access-protection code by placing the remote keypad in the cradle. Disconnect the AC power and then reconnect the AC power.
	Move the remote keypad closer to the base.
Interference is severe	Move the remote keypad closer to the base.
	Keep the base and remote keypad away from interference sources such as computers, radio-controlled toys, wireless microphones, wireless alarm systems, wireless intercoms and room monitors, fluorescent lights, and electrical appliances.
	Turn off the interfering device.
	Hang up and redial the number.
The range decreases	Raise the base unit antenna to a vertical position.
	Recharge the remote keypad battery pack.
The volume level drops or you hear unusual sounds when someone picks up another phone on the same line.	Hang up the second phone.

FCC REQUIREMENTS

Equipment Notes

This equipment complies with Part 68 of the FCC Rules. On the bottom or back of this equipment is a label that contains, among other information, the FCC Registration Number and Ringer Equivalence Number (REN) for this equipment. Upon request, you must, provide this information to your telephone company.

The REN is useful to determine the quantity of devices you may connect to your telephone line and still have all of those devices ring when your telephone number is called. In most, but not all areas, the sum of the REN's of all devices connected to one line should not exceed five (5).

If your telephone equipment causes harm to the telephone network, the telephone company may discontinue your service temporarily. If possible, they will notify you in advance. If advanced notice isn't practical, you will be notified as soon as possible. You will be informed of your right to file a complaint with the FCC.

Your telephone company may make changes in its facilities, equipment, operations or procedures that could affect the proper functioning of your equipment. If they do, you will be notified in advance to give you an opportunity to maintain uninterrupted telephone service.

If you experience trouble with this telephone equipment, disconnect this equipment from the network until the problem has been corrected or until you are sure the equipment is not malfunctioning.

- This equipment may not be used on coin service provided by the telephone company.
- Connection to party lines is subject to state tariffs.

Interference Information

This equipment generates and uses radio frequency energy and if not installed and used properly in strict accordance with the manufacturer's instructions, may cause interference to radio and television reception. It has been tested and found to comply with the limits for a Class B computing device in accordance with the specifications in Part 15 of the FCC Rules, which are designed to provide reasonable protection against such interference in a residential installation.

However, there is no guarantee that interference will not occur in a particular installation. If this equipment does cause interference to radio or television reception, which can be determined by turning the equipment off and on, the user is encouraged to try to correct the interference by one or more of the following measures:

- Reorient the radio or TV receiving antenna. Relocate this device with respect to the receiver. Move this device away from the receiver.
- If necessary, the user should consult the dealer or an experienced radio/television technician for additional suggestions.
- The user may find the following booklet, prepared by the Federal Communications Commission, helpful:

"How to Identify and Resolve Radio-TV Interference Problems"

This booklet is available from the U.S. Government printing Office, Washington, DC 20402, Stock Number. 00-0000-00354-4. There may be a charge for this booklet.