



**SMARTTIRE®**

**Tire Pressure Monitoring  
System Owner's Manual**

017-1-0-000000



SmarTire Systems Inc. reserves the right to change the contents of this manual at any time and without notice. The information contained in this manual is proprietary and must not be reproduced without prior consent from SmarTire Systems Inc.  
 © 2003 SmarTire Systems Inc.

## TABLE OF CONTENTS

<b>Notices</b>	3
FCC Notice	3
European Regulations	4
System Scope of Use and Warnings	4
<i>The SmarTire® System and Tire Maintenance</i>	4
<i>System Installation and Usage</i>	4
<i>Reacting to Alerts</i>	4
<i>Use of Chemicals</i>	5
<i>Power Connection</i>	5
<b>Getting Started</b>	6
Receiver	7
<b>Operation</b>	8
How It Works	8
<b>Installation</b>	10
Transmitter Installation	10
Tools Required	10
Installing Transmitter on a Wheel	10
Mounting Tire with Transmitter on Wheel	12
De-mounting the Tire with Transmitter Installed	14
Receiver Installation	15
<b>Service and Warranty</b>	17
Component Part numbers	17
Troubleshooting	18
Factory Default Settings	18

ENGLISH

FRANÇAIS

DEUTSCH

1

Technical Specifications	19
<i>Strap Mount Transmitter</i>	19
<i>Basic Receiver</i>	20
US Warranty	20
Canadian Warranty	22
European Warranty	23
<b>Appendix</b>	<b>24</b>
Glossary	24
Optional Components	25

## Notices

### FCC NOTICE

This device complies with Part 15 of the FCC Rules. Operation is subject to the following two conditions: (1) this device may not cause harmful interference, and (2) this device must accept any interference received, including interference that may cause undesired operation.

This equipment has been tested and found to comply with the limits for a Class B digital device, pursuant to Part 15 of the FCC Rules. These limits are designed to provide reasonable protection against harmful interference in a residential installation. This equipment generates, uses and can radiate radio frequency energy and, if not installed and used in accordance with the instructions, may cause harmful interference to radio communications. However, there is no guarantee that interference will not occur in a particular installation.

If this equipment does cause harmful interference to radio or television reception, which can be determined by turning the equipment off and on, the user is encouraged to try to correct the interference by one or more of the following measures:

- Reorient or relocate the receiving antenna.
- Increase the separation between the equipment and Receiver.
- Connect the equipment into an outlet on a circuit different from that to which the Receiver is connected.
- Consult the dealer or an experienced radio/TV technician for help.

Changes or modifications to this device without the express approval of SmarTire Systems Inc. may void the user's authority to use this device.

## EUROPEAN REGULATIONS

This device complies with all European Electromagnetic compatibility regulations (95/54/EC and EN300 220-1). The equipment has been tested and found to comply with the above regulations, and in addition it meets the requirements for low powered transmitters/receivers as defined by the relevant radio approval authority. The regulations are designed to provide reasonable protection against harmful interference or susceptibility. Changes made to this device without the express approval of SmarTire Europe Ltd. may void the user's authority to use this device.

## SYSTEM SCOPE OF USE AND WARNINGS

### The SmarTire System and Tire Maintenance

This system is a sensing device designed to identify and display tire operating data and/or activate an alert or warning when pressure irregularities are detected. It is the responsibility of the driver to react promptly and with discretion to alerts and warnings. Abnormal tire inflation pressures should be corrected at the earliest opportunity.

### System Installation and Usage

Use of the SmarTire system requires that it has been properly installed and programmed by personnel according to SmarTire Systems Inc. documentation. This includes the Owner's Manual and any supplementary installation instructions included with system components.

4

This system is suitable for use in passenger and light truck tires up to maximum cold inflation pressure of 65 psi or 4.46 bar.

### Reacting to Alerts

When an alert or warning condition is detected, reduce vehicle speed to an appropriate safe level and proceed to a safe stopping location or facility where

the tire can be inspected and serviced. The *low pressure* alert or *warning* indicates that the air pressure has dropped to a selected minimum.

### Use of Chemicals

Temporary resealing or reinflation products containing internal sealers or propellants in any tire/wheel assembly may adversely affect the operation of the Sensor/Transmitters.

### Power Connection

If your Display is connected to an unkeyed cigarette lighter socket unplug it when you park the vehicle for extended periods (more than three days) to avoid draining the battery or triggering a false diagnostic alert.

## Getting Started

Congratulations! As the owner of this state-of-the-art wireless tire pressure monitoring system, you will enjoy the improved convenience and benefits of having tire pressure information automatically monitored while you are driving.

The SmarTire system consists of wheel mounted Sensor/Transmitters inside each tire which measure contained air pressure and temperature and transmit this data to a Receiver within view of the driver (the optional Full Function Display is required to display pressure and temperature).

Having carried out the correct installation procedure (see Installation section in this manual), the SmarTire system is ready to use.

**Transmitter**

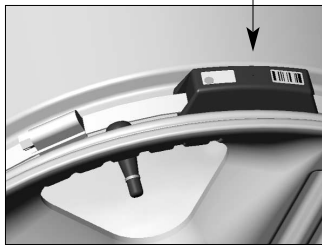

**Basic Receiver**



## RECEIVER

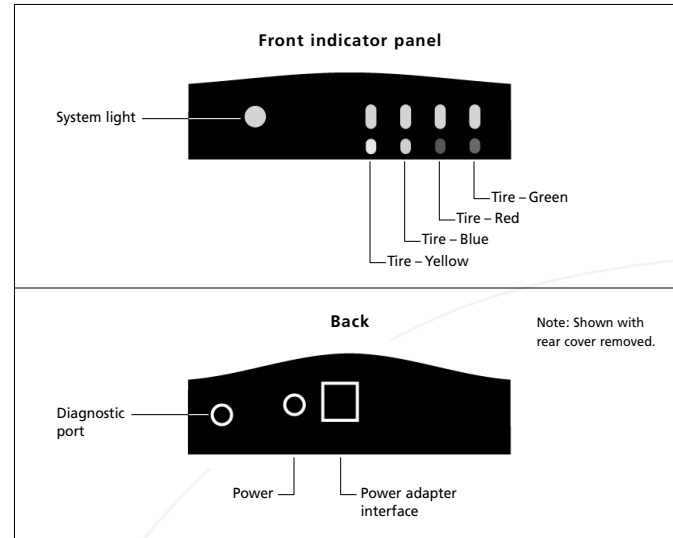

**Note:** Each color on front indicator panel refers to a Transmitter with a corresponding washer color. Color washer must stay with the corresponding color Transmitter during tire rotation.

## Operation

### HOW IT WORKS

The system operates continuously, transmitting air pressure and temperature data,

- At approximately 5 minute intervals when the vehicle is moving faster than 6 mph (10 kph), unless pressure changes, then data is transmitted within 7 seconds.
- Every 20 minutes when the vehicle is parked and pressure drops to 18 psi (1.25 bar) or lower.

**No data received**  
(amber lights flashing)

After the Receiver is turned on, the lights flash red, green, then amber, waiting for Transmitter data.



**All data received**  
(system light green, all others off)

**In Motion:** When transmissions are received amber tire lights turn off one at a time and the system light turns green.



**Low pressure alert**



A **Low Pressure Alert** (factory default 22 psi or 1.53 bar), is identified by an audible alarm and a red illuminated light for the affected tire.



**Alert when parked**



**Parked:** If the vehicle is parked, pressure is measured every 20 minutes and data transmitted if the pressure drops to 18 psi (1.25 bar) or lower. If the Receiver is on, it indicates this with a flashing red illuminated light for the affected tire. If your Receiver stays powered on when the vehicle is parked, all the lights will revert to amber within 40 minutes, except the system light which remains green.

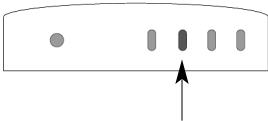

**Low pressure warning**



A **Low Pressure Warning** (factory default 18 psi or 1.25 bar), is identified by a repeated audible alert and a flashing red light, repeated every minute for the affected tire. This continues until tire condition is corrected after which the light turns off.

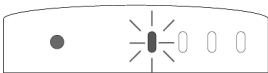

## Installation

### TRANSMITTER INSTALLATION

**Caution:** Qualified personnel must perform the following installation procedures that highlight the steps required to ensure that the Transmitters are properly installed and undamaged. It does not include any standard procedures normally required in the process of replacing a tire (i.e. lubrication, proper inflation and deflation procedures and any other procedures deemed necessary by the tire manufacturer or dealer).

The equipment and images in this manual use one manufacturer's tire changer and may not apply to you.

#### TOOLS REQUIRED

- Tire changing equipment
- Tire balancing equipment
- Hexagon socket and driver (5/16" or 7mm)
- Metal cutter
- Torque wrench

#### INSTALLING TRANSMITTER ON A WHEEL

Shorten the strap by cutting to the appropriate length for the wheel diameter used (see chart). Remove burrs from strap end.

Nominal wheel size (inches)	15	16	17	18	19	20	21	22	23
Cut-off length (inches)	28	25	22	19	15	12	9	6	3
Cut-off length (cm)	71	64	56	48	38	30	23	15	8

10

Below is the suggested installation sequence for use with optional Full Function Display.

Transmitter	Wheel Position
Green	Right front
Red	Left front
Blue	Right rear
Yellow	Left rear

FIG.1



The base of the drop centre well must be flat and wide enough to allow the Transmitter to contact the rim over its complete width. (see Fig.2)

FIG.2

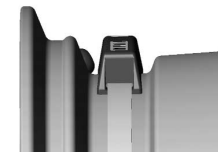

- Pass strap through Transmitter as shown.
- Position the Transmitter in the lowest area of the drop centre well near the valve. (see Fig.3)
- Attach the strap end to the clamp by advancing the wormgear with the socket driver. Tighten to 35 inch pounds (4 N-m).
- Cut off excess strap length to approximately one inch (25 mm) from the wormgear.

FIG.3

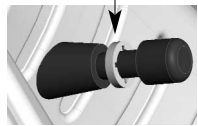

11

<p>Attach the corresponding color of washer on the valve stem as shown. (see Fig.4) Proceed to mount the tire on the wheel. <b>Note:</b> Color washer must stay with the corresponding color Transmitter during installation and tire rotation.</p>	<p>FIG.4</p> 
---	--

**MOUNTING TIRE WITH TRANSMITTER ON WHEEL**

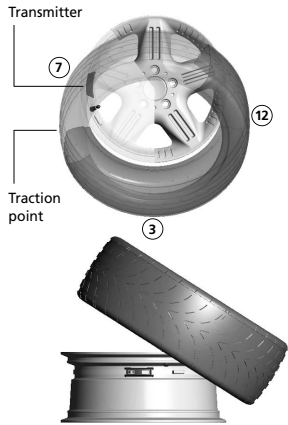
<p>To avoid damaging the Transmitter during tire mounting, position the wheel with the Transmitter located at 7 o'clock in relation to the mount head at 12 o'clock.</p>	
<p>Set the lubricated tire on the wheel with its traction point 3 in. (75 mm) before the Transmitter. Use the mount head to guide the rest of the bottom bead over the flange and onto the rim.</p>	
<p>With the bottom bead in place, you will be able to position the wheel with the Transmitter at 7 o'clock for most tires. Depress the bead into the drop centre so that the traction point is 3 in. (75 mm) before the Transmitter.</p>	

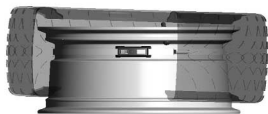
<p>Some stiff side wall tires (such as "run-flats") require setting the Transmitter between 3 o'clock and 6 o'clock. Start the top bead in front of the mount head assisting with the mounting bar to prevent slippage.</p> <p>Inflate the tire to seat the bead, deflate completely and then inflate the tire to manufacturer's recommended cold inflation pressure. Balance the wheel.</p>	
--	---

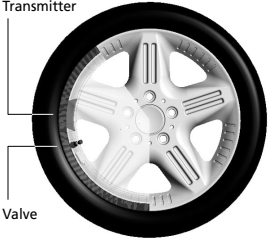

**DE-MOUNTING THE TIRE WITH TRANSMITTER INSTALLED**

<p>Remove the tire/wheel assembly from vehicle and deflate completely.</p>	 <p>Transmitter</p> <p>Valve</p>
<p>Loosen both beads with the bead loosener shoe opposite the valve stem (away from the Transmitter which is located near the valve stem). Verify the Transmitter location.</p>	
<p>Orient the wheel to place the Transmitter 3 in. (75 mm) to the left of the bead guiding shoe so that the mounting bar will clear the Transmitter. When lifting the top bead the tire must be clear of the Transmitter. Remove the top bead.</p>	
<p>Set the wheel once more with the Transmitter 3 in. (75 mm) to the left of the bead guiding shoe and remove the bottom bead. The Transmitter should be checked for correct positioning and fit prior to tire replacement.</p>	

**RECEIVER INSTALLATION**

The Receiver is installed:

1. By mounting in a convenient location
  - With bracket and suction cups to windshield
  - With bracket and screws (provided by user)
  - With Velcro strips to dash
2. Plug in power
  - With power cable
  - Using the power adapter (accessory)

RECEIVER ATTACHED TO WINDSHIELD WITH BRACKET AND SUCTION CUPS



RECEIVER ATTACHED TO SURFACE WITH VELCRO® STRIPS



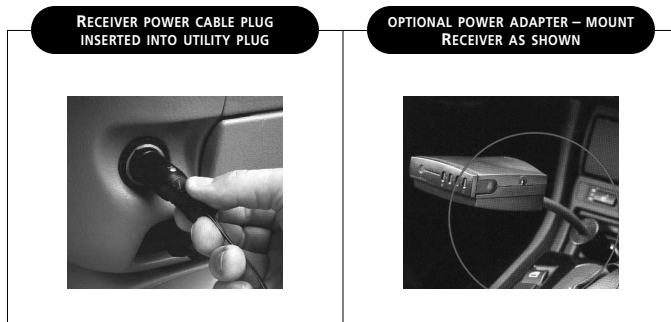

For universal vehicle installations, the Basic Receiver can be plugged into a utility power outlet or cigarette lighter socket using the supplied power cable. For permanent connection to vehicle's power supply, the Basic Receiver can be hardwired to a keyed power circuit. Only personnel trained in adapting wiring systems should attempt this installation.

## Service and Warranty

### COMPONENT PART NUMBERS



**TROUBLESHOOTING**

<b>Problem</b>	<b>Cause and actions</b>
Receiver lights do not turn on	No power to Receiver. Check power connection at receiver end and at utility plug. Check fuse in power plug. Reseat connectors if required. Ensure the lead is not plugged into the diagnostic port.
Tire indicator light stays amber	Data not received from Transmitter location. Relocate Receiver as interference may be the issue. If problem is not corrected contact your dealer.
Alert light turns on but air pressure is normal in tire	Verify that the alert and wheel color codes match. Confirm tire inflation pressure with accurate gauge. Contact your dealer.

**FACTORY DEFAULT SETTINGS**

Low Pressure Alert	22 psi	1.53 bar
Low Pressure Warning	18 psi	1.25 bar

**TECHNICAL SPECIFICATIONS****Strap Mount Transmitter**

Battery Life (Projected)	> 5 Years normal vehicle use
Operating temperature range	-40° F to 257° F (-40° C to 125° C)
Operating humidity	95% non condensing
Weight	40g (1.41 oz)
Size	3-1/4" x 1-1/8" x 1" (83 mm x 29 mm x 25 mm)
Frequency	433.92 MHz
Pressure Range	0 – 78 psi (5.38 bar)
Pressure accuracy	+/- 1.5 psi (0.1 bar)
Temperature accuracy	+/- 3° C (5° F)
Transmitter activation	Vehicle motion greater than 6mph (10 kph)

<b>Basic Receiver</b>	
Power Consumption	20 ma. nominal, 125 ma. maximum during alert
Operating Temperature Range	-40° F to 185° F (-40° C to 85° C)
Frequency	433.92 MHz ± 75 KHz
Size	2.85" W x 3.08" D x 0.87" H (72 mm W x 78 mm D x 22 mm H)
Weight	67 gm (2.4 oz)
Operating Humidity	100% non condensing

#### **US WARRANTY**

This Warranty covers substantial manufacturer's defects in workmanship and materials. It does not cover any unit that is damaged beyond normal usage, was not properly installed, was subjected to chemical contact, or other acts or omissions not sanctioned by the Owner's Manual.

All components are covered for one (1) year and unlimited mileage following the date of purchase.

20

The SmarTire® Warranty will be honored by any authorized SmarTire® dealer. The owner is required to provide dated proof of purchase. The authorized dealer will determine if there is a warrantable condition associated with materials and/or manufacturing workmanship. If a warrantable condition exists, the component will be replaced free of charge, shipping prepaid. The owner is responsible for any labor and installation charges.

Telephone 604-276-9884 to obtain a Return Material Authorization (RMA) number. Send the postage prepaid package with the defective unit and RMA number to: SmarTire USA Inc., PMB 309, 1700 W. Market Street, Akron, Ohio, USA, 44313.

The Warranty does not include any further obligation whatsoever, including but not limited to actual installation of the replacement unit on the customer's vehicle.

All other Warranties, express or implied, are disclaimed. All collateral agreements, which purport to modify this Limited Warranty are of no effect. The absolute limit of liability is the purchase price of the unit. SmarTire Systems Inc. is not liable for any direct, consequential, indirect or punitive damages of any kind.

SOME STATES DO NOT ALLOW LIMITATIONS ON THE VALIDITY OR LENGTH OF IMPLIED WARRANTIES, SO THE ABOVE LIMITATIONS MAY NOT APPLY TO YOU.

SOME STATES DO NOT ALLOW THE EXCLUSION OR LIMITATION OF INCIDENTAL OR CONSEQUENTIAL DAMAGES, SO THE ABOVE LIMITATION OR EXCLUSION MAY NOT APPLY TO YOU.

THIS WARRANTY GIVES YOU SPECIFIC LEGAL RIGHTS, AND YOU MAY HAVE OTHER RIGHTS WHICH VARY FROM STATE TO STATE.

21

**CANADIAN WARRANTY**

This Warranty covers substantial manufacturer's defects in workmanship and materials. It does not cover any unit that is damaged beyond normal usage, was not properly installed, was subjected to chemical contact, or other acts or omissions not sanctioned by the Owner's Manual.

All components are covered for one (1) year and unlimited mileage following the date of purchase.

The SmarTire® Warranty will be honoured by any authorized SmarTire® dealer. The owner is required to provide dated proof of purchase. The authorized dealer will determine if there is a warrantable condition associated with materials and/or manufacturing workmanship. If a warrantable condition exists, the component will be replaced free of charge, shipping prepaid, if within the applicable warranty period. The owner is responsible for any labour and installation charges.

Telephone 604-276-9884 to obtain a Return Material Authorization (RMA) number. Send the postage prepaid package with the defective unit and RMA number to: SmarTire Systems Inc., 13151 Vanier Place, Suite 150, Richmond, British Columbia, Canada, V6V 2J1.

The Warranty does not include any further obligation whatsoever, including but not limited to actual installation of the replacement unit on the customer's vehicle.

- 22 ALL OTHER WARRANTIES AND CONDITIONS, EXPRESS OR IMPLIED, INCLUDING WARRANTIES AND CONDITIONS FOR MERCHANTABILITY, DURABILITY OR FITNESS FOR PURPOSE, ARE DISCLAIMED. ALL COLLATERAL AGREEMENTS, WHICH MODIFY THIS SOLE WARRANTY ARE OF NO EFFECT. SMARTIRE SYSTEMS INC. IS NOT LIABLE FOR ANY DIRECT, CONSEQUENTIAL, INDIRECT OR PUNITIVE DAMAGES. THE ABSOLUTE LIMIT TO LIABILITY IS THE PURCHASE PRICE OF THE UNIT.

**EUROPEAN WARRANTY**

SmarTire Europe Limited ("SmarTire") hereby warrants that this SmarTire wireless tyre pressure monitoring system shall be free from material defects in workmanship and/or materials until the expiry of 24 months from its purchase by the end user and unlimited mileage, EXCEPT WHERE any such defect has been caused by:

1. Improper installation;
2. Improper or non-normal use;
3. Contact with any corrosive or otherwise harmful substance; or
4. Any other act or omission not sanctioned by the Owner's Manual or any failure to follow any other reasonable instructions given by SmarTire in relation to the system.

The above warranty will be honoured by the retailer from which it was purchased, provided that the owner can provide dated proof of purchase.

The retailer shall at their own cost return any unit suspected to be defective. If the unit is subsequently found to be defective then the carriage costs shall be refunded in full. Send the postage prepaid package with the defective unit to: SmarTire, Park 34, Didcot, Oxfordshire OX11 7WB, England.

In the event that any defect in the unit is covered by the above warranty, SmarTire will replace the affected components free of charge, shipping prepaid. The owner shall be responsible for any labour and installation costs incurred in removing the defective parts and/or installing the replacements.

SAVE AS SET OUT HEREIN SMARTIRE SHALL HAVE NO FURTHER LIABILITY OR OBLIGATION UNDER THE ABOVE WARRANTY. THIS WARRANTY SHALL BE GOVERNED AND CONSTRUED IN ACCORDANCE WITH ENGLISH LAW.

YOUR STATUTORY RIGHTS ARE NOT AFFECTED.

## Appendix

### GLOSSARY

<i>Cold Pressure</i>	The vehicle manufacturers recommended inflation pressure of a tire at ambient temperature (64° F or 18° C).
<i>Low Pressure Alert</i>	The audible and visual alert activated when the tire's Actual Pressure drops to the programmed value.
<i>Low Pressure Warning</i>	The audible and visual alert activated when the tire's Actual Pressure drops to the programmed value. This value is lower than the Low Pressure Alert.
<i>Receiver</i>	The electronic module that receives data from the Transmitter and displays tire pressure alerts.
<i>Transmitter</i>	The wheel mounted electronic module that measures contained air pressure and transmits this data to the Receiver.

### OPTIONAL COMPONENTS

#### Full Function Display (two versions)

See Full Function Display manual for details on installation and operation.

