

Bendix® SR-1™ Spring Brake Valve

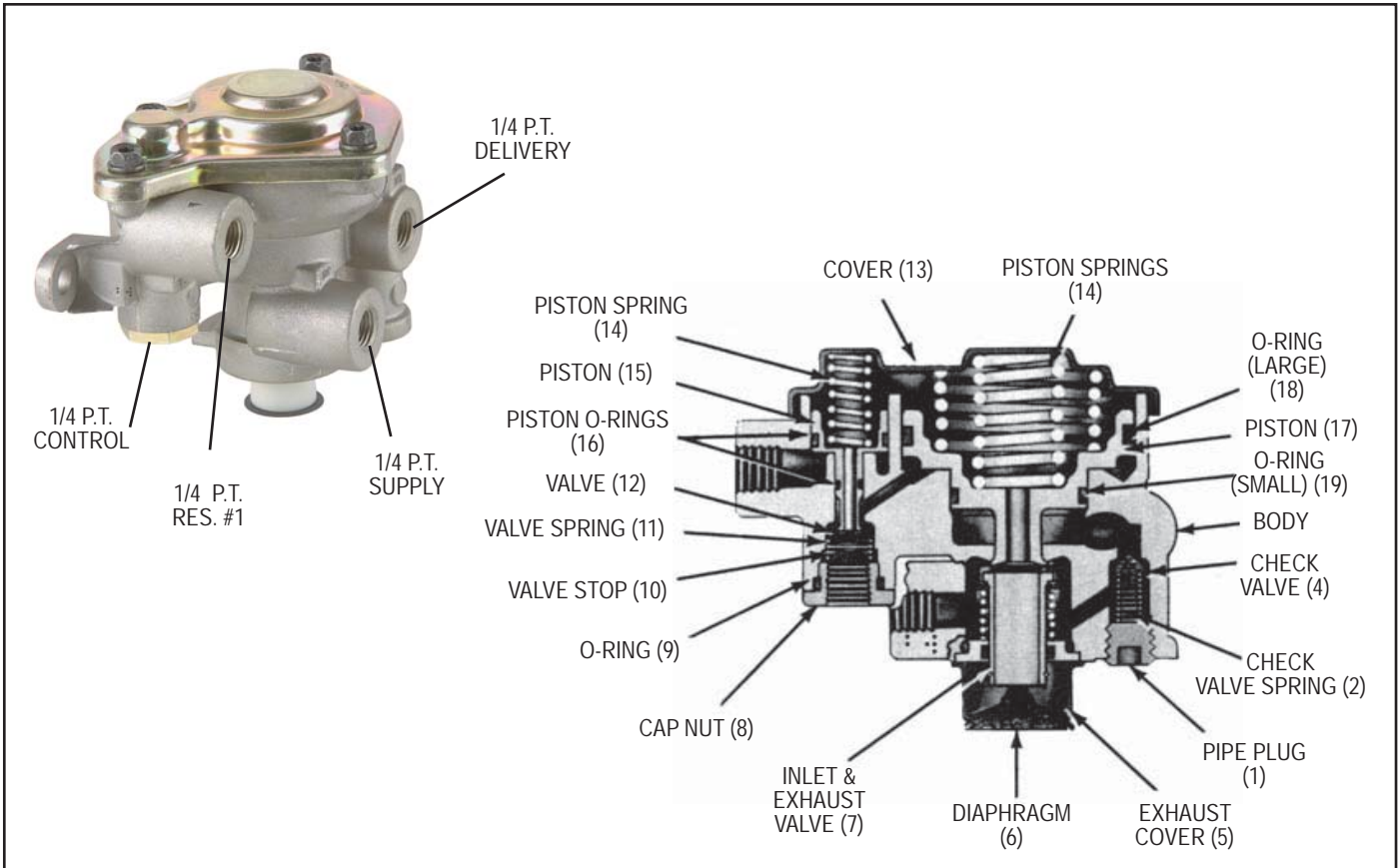

FIGURE 1 - BENDIX® SR-1™ VALVE EXTERIOR AND SECTIONAL VIEW

DESCRIPTION:

The Bendix® SR-1™ spring brake valve is used in dual or “split” air brake systems equipped with spring brake actuators. The function of the SR-1 valve is to supply a specific, limited hold-off pressure to the spring brakes, and in the event of the loss of No. 1 service air pressure, to modulate the spring brakes through the use of the service brake valve.

The valve has four identified 1/4" N.P.T.F. ports and a diaphragm protected exhaust port. Two 5/16" diameter holes are provided in the integral mounting bracket of the valve body. The SR-1 valve must be mounted with the exhaust port down toward the road surface.

OPERATION - INITIAL AIR SYSTEM CHARGE

Air flowing from the No. 1 reservoir only enters the reservoir port of the SR-1 valve. This air remains under piston A as system pressure builds. With No. 1 reservoir pressure below approximately 55 P.S.I. the spring above piston A forces it into contact with inlet and exhaust valve A causing the exhaust to seal and the inlet to open. Refer to Figure 3.

With air system pressure above approximately 55 P.S.I. in No. 1 & 2 service reservoirs, piston A has moved against the force of the spring above it, allowing the inlet of valve A to close and opening the hollow exhaust passage through piston A. Refer to Figure 4.

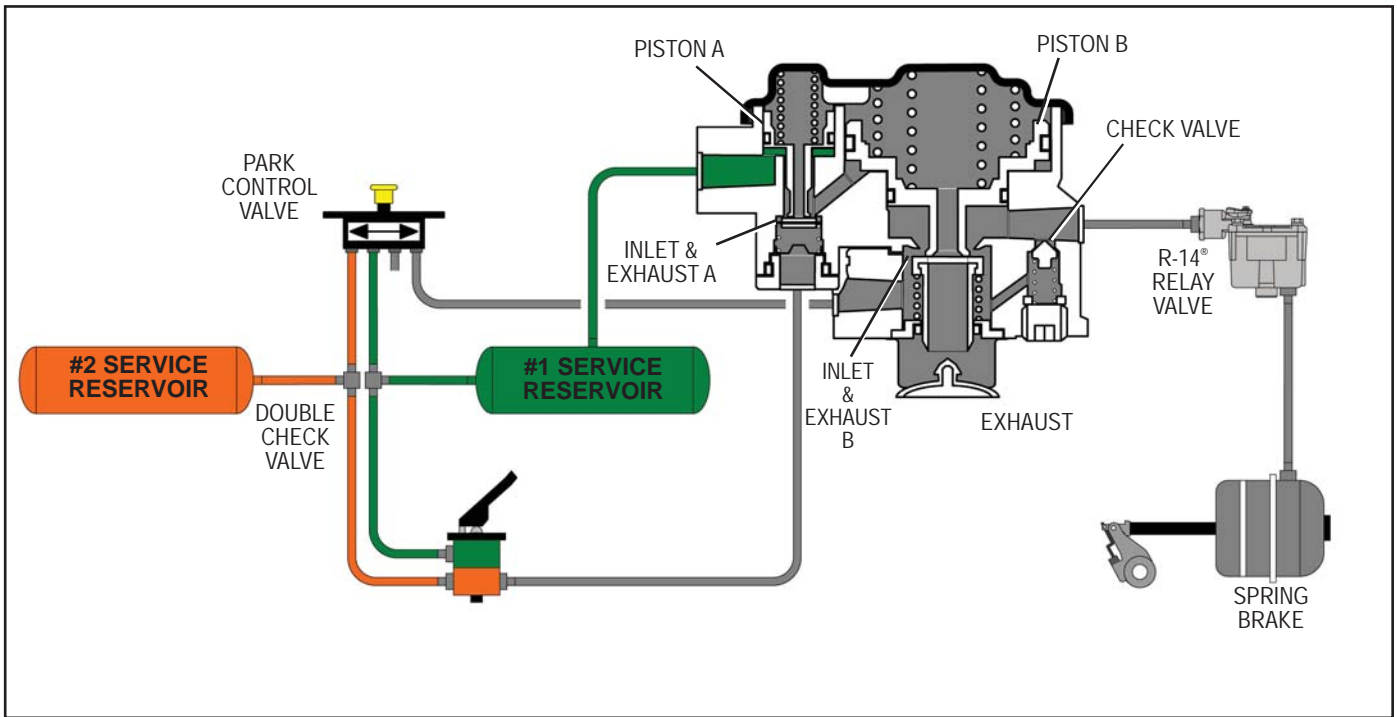

FIGURE 4 - RESERVOIRS CHARGING - ABOVE 55 P.S.I.

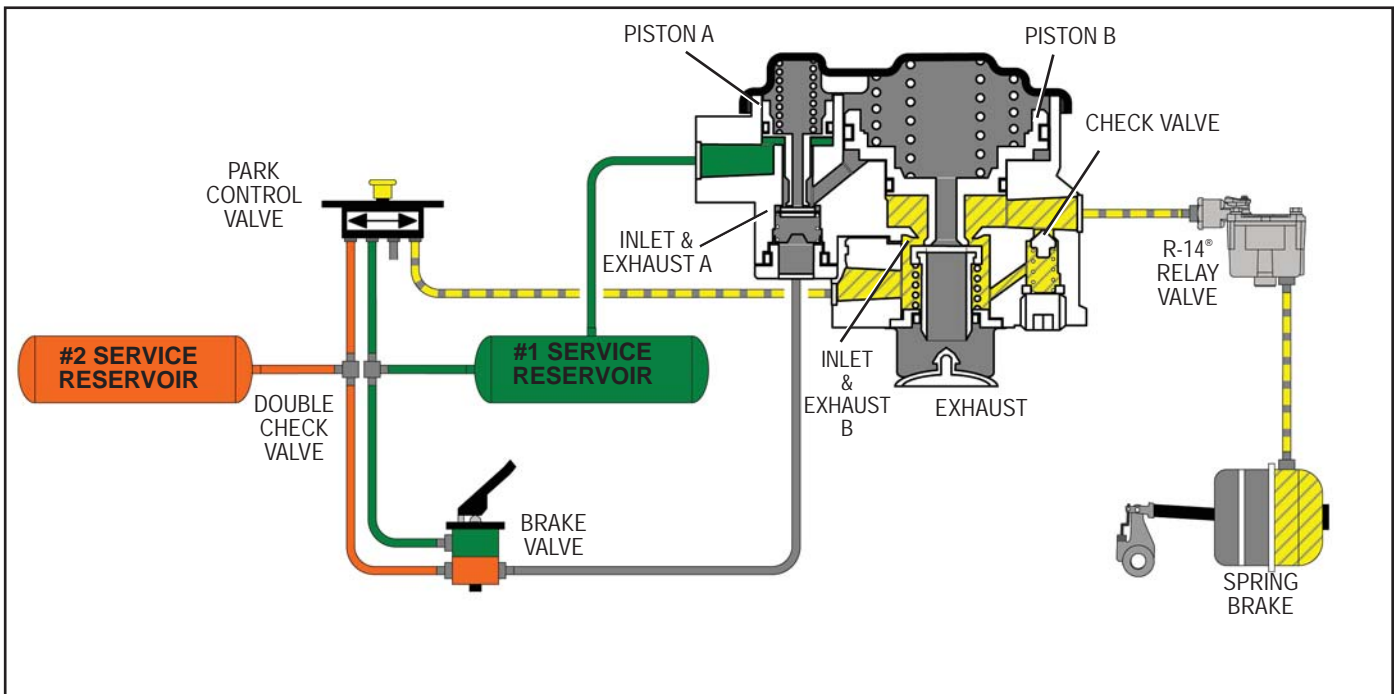

FIGURE 5 - PARKING BRAKE SUPPLY DELIVERY LESS THAN 95 P.S.I.

OPERATION - CHARGING SPRING BRAKE ACTUATORS LESS THAN 95 PSI

With the air brake system charged and the dash valve pushed in, air enters the Bendix® SR-1™ valve supply port. Air entering the supply port flows past inlet and exhaust valve B to the underside of piston B and out the delivery port of the SR-1 valve to the Bendix® R-14® parking relay valve then to the emergency air connection at the spring brake actuator. Note that the springs above piston B force it into contact with inlet and exhaust valve B. In the position shown the exhaust is closed and the inlet is open.

OPERATION - CHARGING SPRING BRAKE ACTUATORS ABOVE 95 PSI

When air pressure beneath piston B is approximately 95* P.S.I., piston B rises slightly, against the force of the springs above it, allowing the inlet of valve B to close. The exhaust through valve B remains closed. The closing of the inlet portion of valve B retains approximately 95* P.S.I. in the hold- off cavity of the spring brake actuators while allowing full air system pressure to build elsewhere. Refer to Figures 5 and 6.

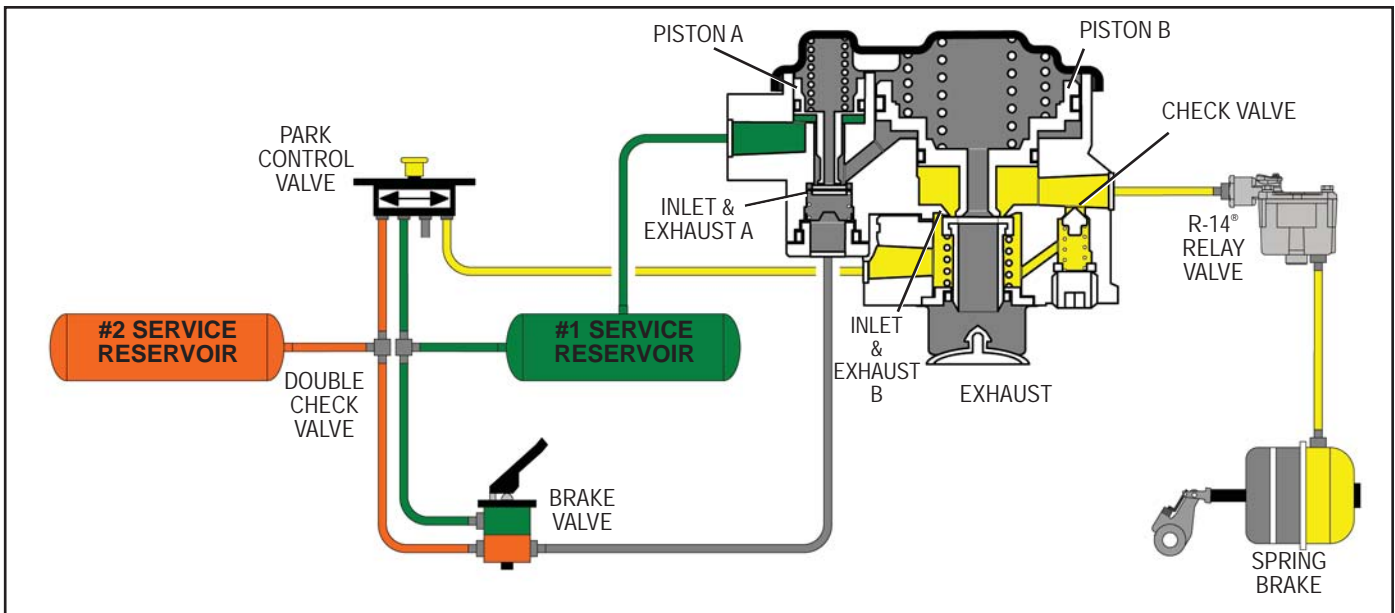

FIGURE 6 - PARKING BRAKE SUPPLY DELIVERY EQUAL TO OR GREATER THAN 95 P.S.I.

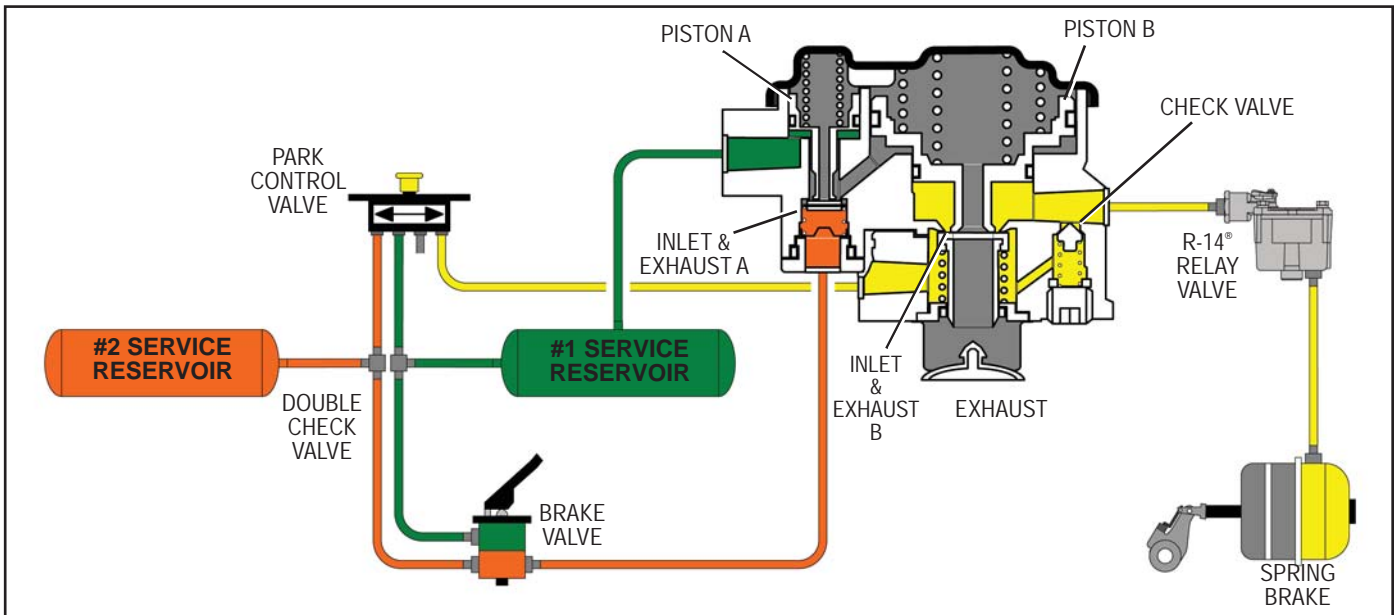

FIGURE 7 - NORMAL SERVICE APPLICATION

*Note: Other spring brake hold-off pressures are supplied according to the vehicle manufacturer's specifications. 95 P.S.I. was chosen only for the purpose of explanation.

OPERATION - NORMAL SERVICE RESERVOIRS 1 & 2 CHARGED

When a service application is made by actuating the dual brake valve, air from the No. 2 delivery circuit is delivered from the brake valve to the control port, and is stopped at the closed inlet of valve A. No movement of the internal components of the Bendix® SR-1™ valve takes place. Air from the No. 1 delivery circuit of the dual brake valve actuates the service section of the spring brake actuators. Refer to Figure 7.

OPERATION - SERVICE APPLICATION WITH LOSS OF NO. 2 RESERVOIR PRESSURE

In the event air pressure is lost in the No. 2 reservoir, the No. 1 reservoir and the parking control valve will be protected via the double and single check valves in the air system. A service application of the foot brake valve in this situation results in little or no air being delivered from the No. 2 delivery circuit to the control port of the SR-1 valve. No movement of the SR-1 valve internal components takes place. Braking is assured because the No. 1 service reservoir is protected by a check valve and the No. 1 delivery circuit of the dual brake valve will apply the service section of the spring brake actuators.

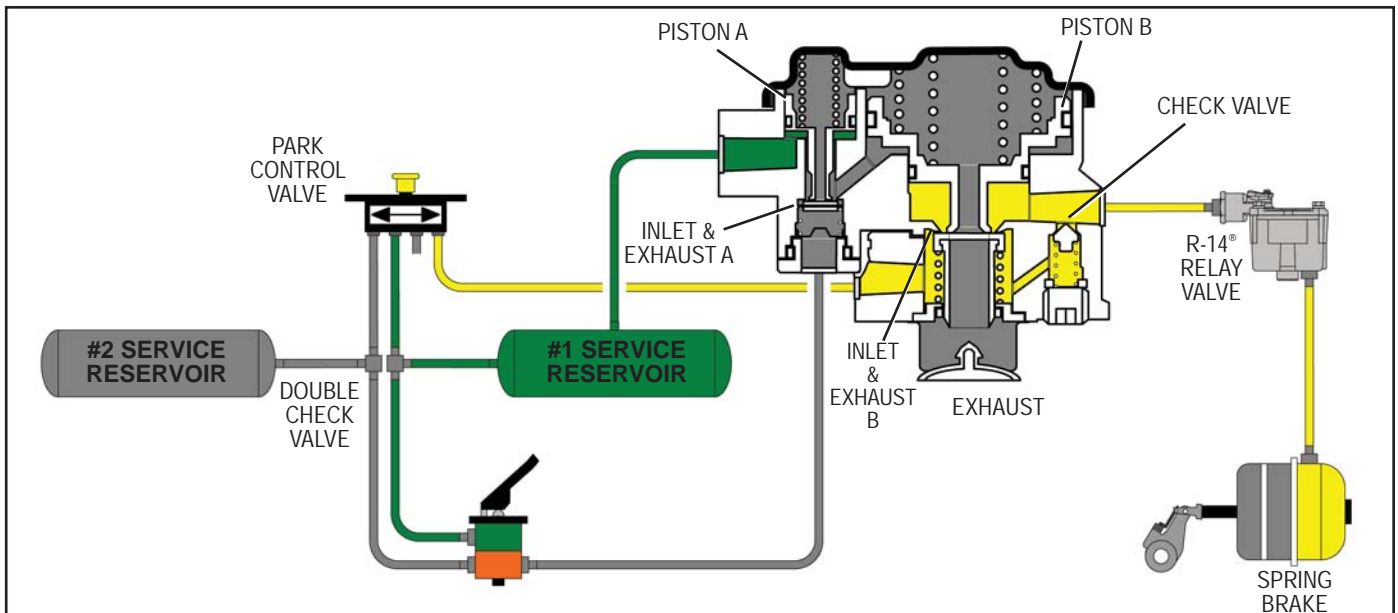

FIGURE 8 - SERVICE APPLICATION - LOSS OF #2 RESERVOIR

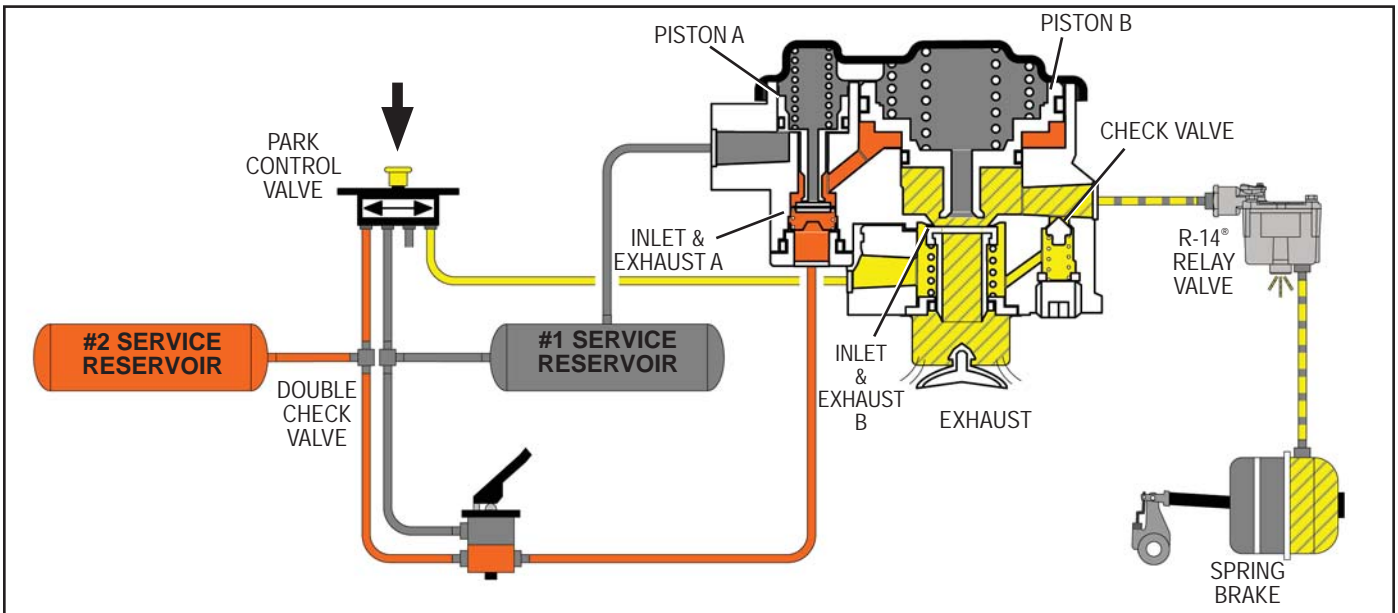

FIGURE 9 - SERVICE APPLICATION - LOSS OF #1 RESERVOIR

OPERATION - SERVICE APPLICATION WITH LOSS OF NO. 1 RESERVOIR PRESSURE

If air pressure in the No. 1 service reservoir falls below approximately 55 P.S.I., the pressure beneath piston A is insufficient to resist the spring force above and piston A moves into contact with valve A. Initial contact between piston A and valve A closes the hollow exhaust passage of piston A. Continued movement of the piston opens the inlet of valve A.

The No. 2 service reservoir and the park control valve are protected from pressure loss by the action of the double check valve.

When a service application of the dual brake valve is made, air delivered from the No. 2 delivery circuit of the dual brake valve enters the Bendix® SR-1™ valve control port. Air entering the control port moves past the inlet of valve A and is conducted through a passage in the body to the underside of piston B. The air pressure moves piston B up, opening the exhaust of valve B. When the exhaust of valve B opens, air pressure trapped in the emergency section of the spring brake actuator is allowed to escape, resulting in an emergency brake application. The air pressure released from the spring brake is proportional to the air pressure delivered to the control port of the SR-1 valve by the No. 2 delivery of the dual brake valve.

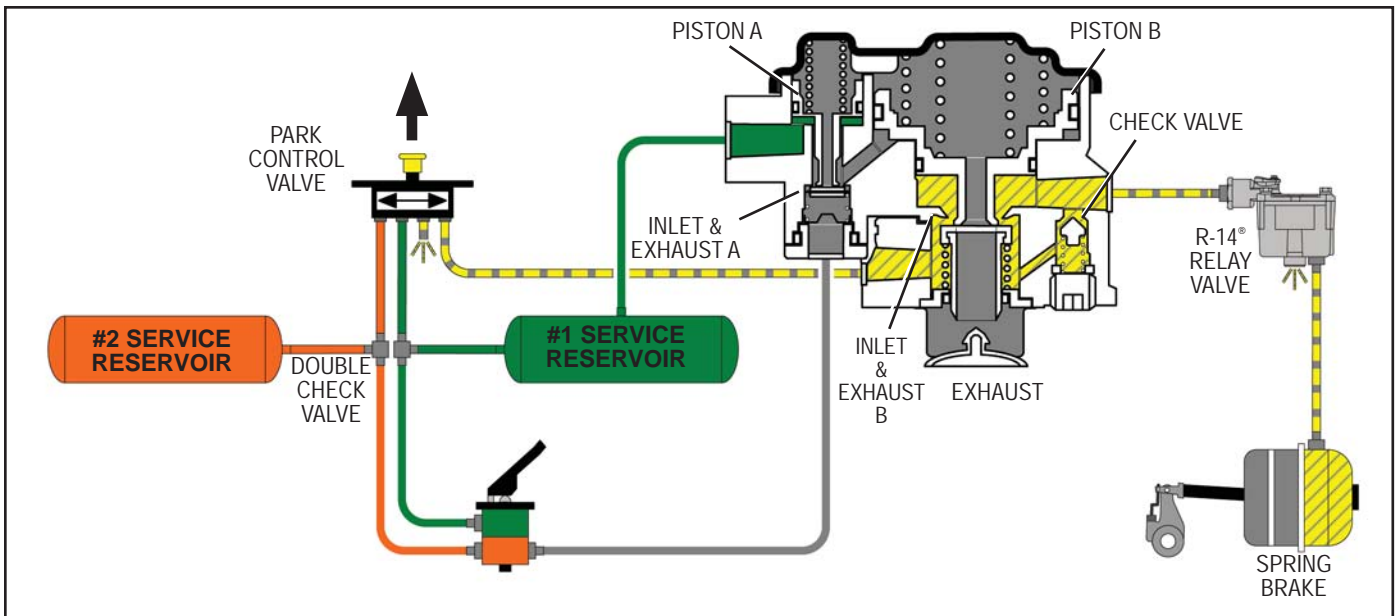

FIGURE 10 - PARK APPLICATION

OPERATION - PARKING

If both systems #1 and #2 are intact and the park control valve is placed in the “park” or exhaust position, the Bendix® SR-1™ valve supply of air pressure and the air pressure in the spring brake actuator cavities is exhausted. The single check valve in the SR-1 valve assists this exhaust of air pressure by allowing the air below piston B to flow back out the open exhaust of the park control valve. When air pressure below piston B has dropped sufficiently, piston B moves down, opening the inlet of valve B and providing an additional exhaust passage for air exhausting through the SR-1 valve from the spring brakes.

PREVENTIVE MAINTENANCE

Important: Review the Bendix Warranty Policy before performing any intrusive maintenance procedures. A warranty may be voided if intrusive maintenance is performed during the warranty period.

No two vehicles operate under identical conditions, as a result, maintenance intervals may vary. Experience is a valuable guide in determining the best maintenance interval for air brake system components. At a minimum, the SR-1 valve should be inspected every 6 months or 1500 operating hours, whichever comes first, for proper operation. Should the SR-1 valve not meet the elements of the operational tests noted in this document, further investigation and service of the valve may be required.

SERVICE CHECKS

OPERATING CHECKS

Block all wheels and hold by means other than vehicle brakes. Charge air brake system to governor cut-out pressure.

1. Place parking control valve in the “park” position. Observe that the spring brake actuators apply promptly. In the delivery port of the valve install a test gauge known to be accurate. Place the parking control valve in the “release” position. Observe that the spring brake actuators release fully.
2. With the parking control valve in the “release” position, note the gauge pressure reading. (Check the vehicle manual for the correct spring brake actuator hold-off pressure.) If the pressure reading is incorrect, the valve must be repaired or replaced.
3. Place the parking control valve in the “park” position, the gauge reading should drop to zero promptly. A slow release of pressure may indicate faulty operation of the single check valve (within the modulating valve.)
4. Place the parking control valve in the “release” position. Locate the number one service reservoir and drain it completely.

Apply the foot brake valve several times and note that the pressure reading on the gauge decreases each time the foot brake valve is applied. After several applications, pressure on the gauge will drop to the point where release of the spring brake actuators will no longer occur.

LEAKAGE CHECK

With the air system fully charged and the parking control valve in the “release” position, coat the exhaust port and around the valve corner with a soap solution. Slight leakage is permitted.

If the Bendix® SR-1™ spring brake valve does not function as described previously, or leakage is excessive, it is recommended that it be repaired or replaced with a genuine Bendix service replacement valve.

Note: A maintenance kit for the SR-1 spring brake valve is available from any authorized Bendix outlet. All parts necessary for minor repair are included.

REMOVAL

1. Prior to removing the SR-1 valve, apply the parking brakes and drain all the vehicle reservoirs.
2. Identify all air lines before disconnecting.
3. Remove the two mounting bolts from the SR-1 valve and remove the valve.

DISASSEMBLY (REFER TO FIGURE 1)

1. Remove the socket head pipe plug (1).
2. Remove the check valve spring (2) and the check valve (4).
3. Remove the two phillips head screws and remove the exhaust cover (5).
4. Separate the exhaust diaphragm (6) from the cover.
5. Remove the inlet and exhaust valve assembly (7).
6. Remove the inlet and exhaust valve cap nut (8) and separate the cap nut o-ring (9).
7. Remove the valve stop (10) valve spring (11) and inlet and exhaust valve (12).
8. Remove the four phillips head screws and lockwashers that secure the cover to the body. Caution: the cover is under a spring load, and should be held while removing the screws.
9. Remove the cover (13) and the three piston springs (14). Note: Some SR-1 valve piece numbers have one large piston spring.
10. Remove the small piston (15) and the small and large o-rings (16).
11. Remove the large piston (17). Remove piston o-rings (18) & (19).

CLEANING & INSPECTION

1. Inspect all parts for excessive wear or deterioration.
2. Inspect the valve seats for nicks or burrs.
3. Check the springs for cracks or corrosion.
4. Replace all rubber parts and any part not found to be serviceable during inspection. Use only genuine Bendix replacement parts.

ASSEMBLY (REFER TO FIGURE 2)

Prior to assembly of the SR-1 spring brake valve, lubricate all o-rings, o-ring grooves, and piston bores with Bendix silicone lubricant BW-650-M piece number 291126.

Note: All torques specified in this manual are assembly torques and can be expected to fall off, after assembly is accomplished. Do not retorque after initial assembly torques fall.

1. Assemble the check valve (4), and valve spring (2) and install in body.
2. Apply pipe sealant to the socket head pipe plug (1) and install in the body. Tighten to 130-170 inch pounds torque.
3. Install inlet and exhaust valve assembly (7) in valve body.
4. Secure the exhaust cover (5) with two 10-24 phillips head screws and lockwashers. Tighten to 20-30 inch pounds torque.
5. Install exhaust diaphragm (6) into the exhaust cover.
6. Place inlet exhaust valve (12) in the body. Install the valve spring (11) and valve stop (10).
7. Install o-ring (9) on cap nut and install cap nut (8) in body. Tighten to 100-125 inch pounds torque.
8. Install the small and large o-rings (16) on the small diameter piston (15) and install piston in the body.
9. Install large o-ring (18) and small o-ring (19) on the large diameter piston and install piston in the body.
10. Install the piston springs (14) in their respective pistons.
11. Secure the cover to body using four 1/4"-20 phillips head screws and lockwashers. Tighten to 50-80 inch pounds torque.

TESTING THE REBUILT BENDIX® SR-1™ SPRING BRAKE VALVE

Test the rebuilt SR-1 spring brake valve by performing the operation and leakage test outlined in the “Service Checks” section of this manual.

GENERAL SAFETY GUIDELINES

WARNING! PLEASE READ AND FOLLOW THESE INSTRUCTIONS TO AVOID PERSONAL INJURY OR DEATH:

When working on or around a vehicle, the following general precautions should be observed at all times.

1. Park the vehicle on a level surface, apply the parking brakes, and always block the wheels. Always wear safety glasses.
2. Stop the engine and remove ignition key when working under or around the vehicle. When working in the engine compartment, the engine should be shut off and the ignition key should be removed. Where circumstances require that the engine be in operation, **EXTREME CAUTION** should be used to prevent personal injury resulting from contact with moving, rotating, leaking, heated or electrically charged components.
3. Do not attempt to install, remove, disassemble or assemble a component until you have read and thoroughly understand the recommended procedures. Use only the proper tools and observe all precautions pertaining to use of those tools.
4. If the work is being performed on the vehicle's air brake system, or any auxiliary pressurized air systems, make certain to drain the air pressure from all reservoirs before beginning ANY work on the vehicle. If the vehicle is equipped with a Bendix® AD-IS® air dryer system or a dryer reservoir module, be sure to drain the purge reservoir.
5. Following the vehicle manufacturer's recommended procedures, deactivate the electrical system in a manner that safely removes all electrical power from the vehicle.
6. Never exceed manufacturer's recommended pressures.
7. Never connect or disconnect a hose or line containing pressure; it may whip. Never remove a component or plug unless you are certain all system pressure has been depleted.
8. Use only genuine Bendix® brand replacement parts, components and kits. Replacement hardware, tubing, hose, fittings, etc. must be of equivalent size, type and strength as original equipment and be designed specifically for such applications and systems.
9. Components with stripped threads or damaged parts should be replaced rather than repaired. Do not attempt repairs requiring machining or welding unless specifically stated and approved by the vehicle and component manufacturer.
10. Prior to returning the vehicle to service, make certain all components and systems are restored to their proper operating condition.
11. For vehicles with Automatic Traction Control (ATC), the ATC function must be disabled (ATC indicator lamp should be ON) prior to performing any vehicle maintenance where one or more wheels on a drive axle are lifted off the ground and moving.

