

## Bendix® SR-7® Spring Brake Modulating Valve

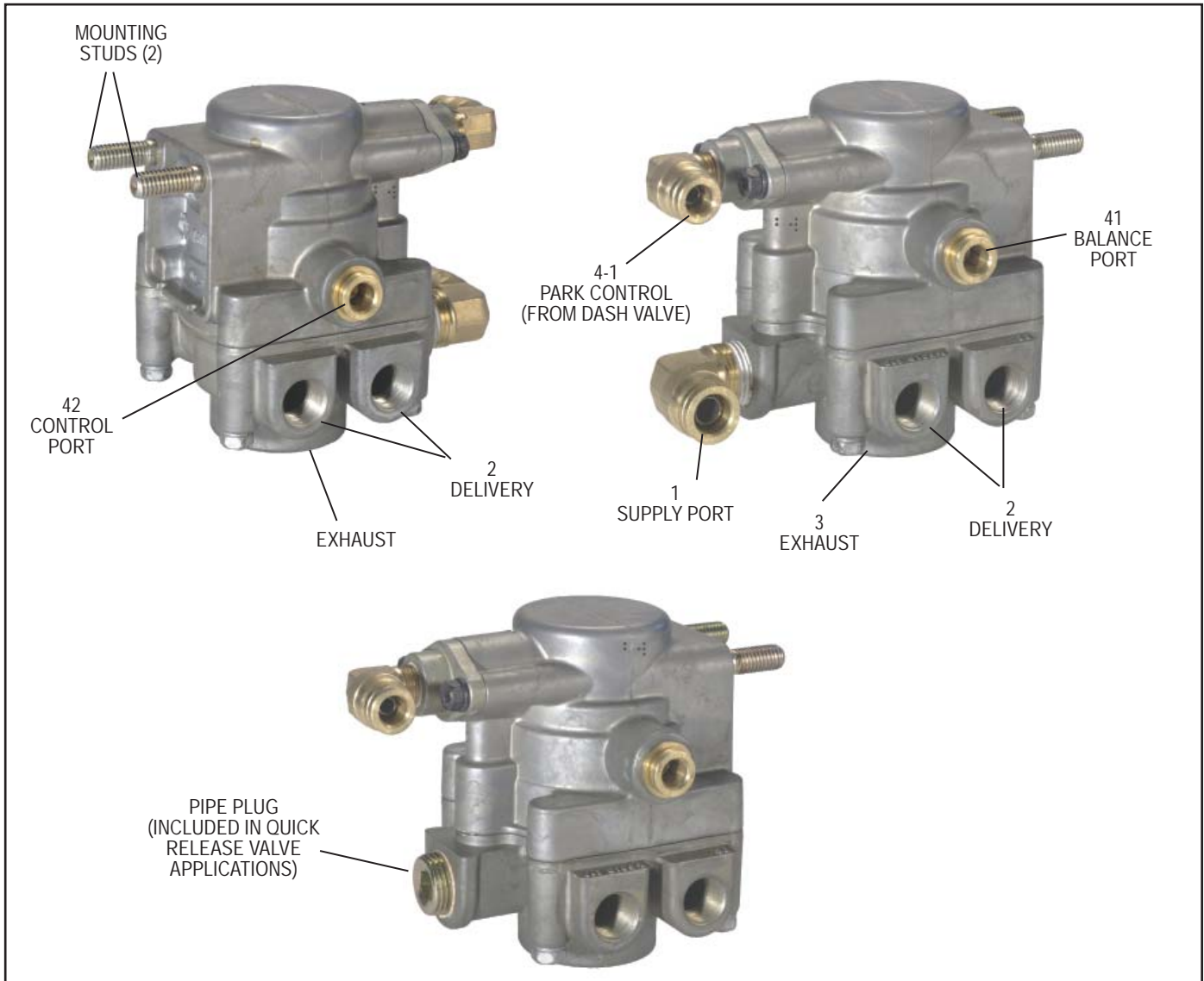

FIGURE 1 - EXTERIOR VIEW

### DESCRIPTION

The Bendix® SR-7® spring brake modulating valve is used in conjunction with a dual air brake system and spring brake actuator and performs the following functions:

1. Provides a rapid application of the spring brake actuator when parking.
2. Modulates the spring brake actuator application using the dual brake valve should a primary failure occur in the service brake system.

3. Prevents compounding of service and spring forces.
- The valve has one park control, one service control, one supply, one balance, four delivery NPTF ports, and an exhaust port protected by an exhaust diaphragm. The valve incorporates two mounting studs for mounting the valve to the frame rail or cross member (where applicable).

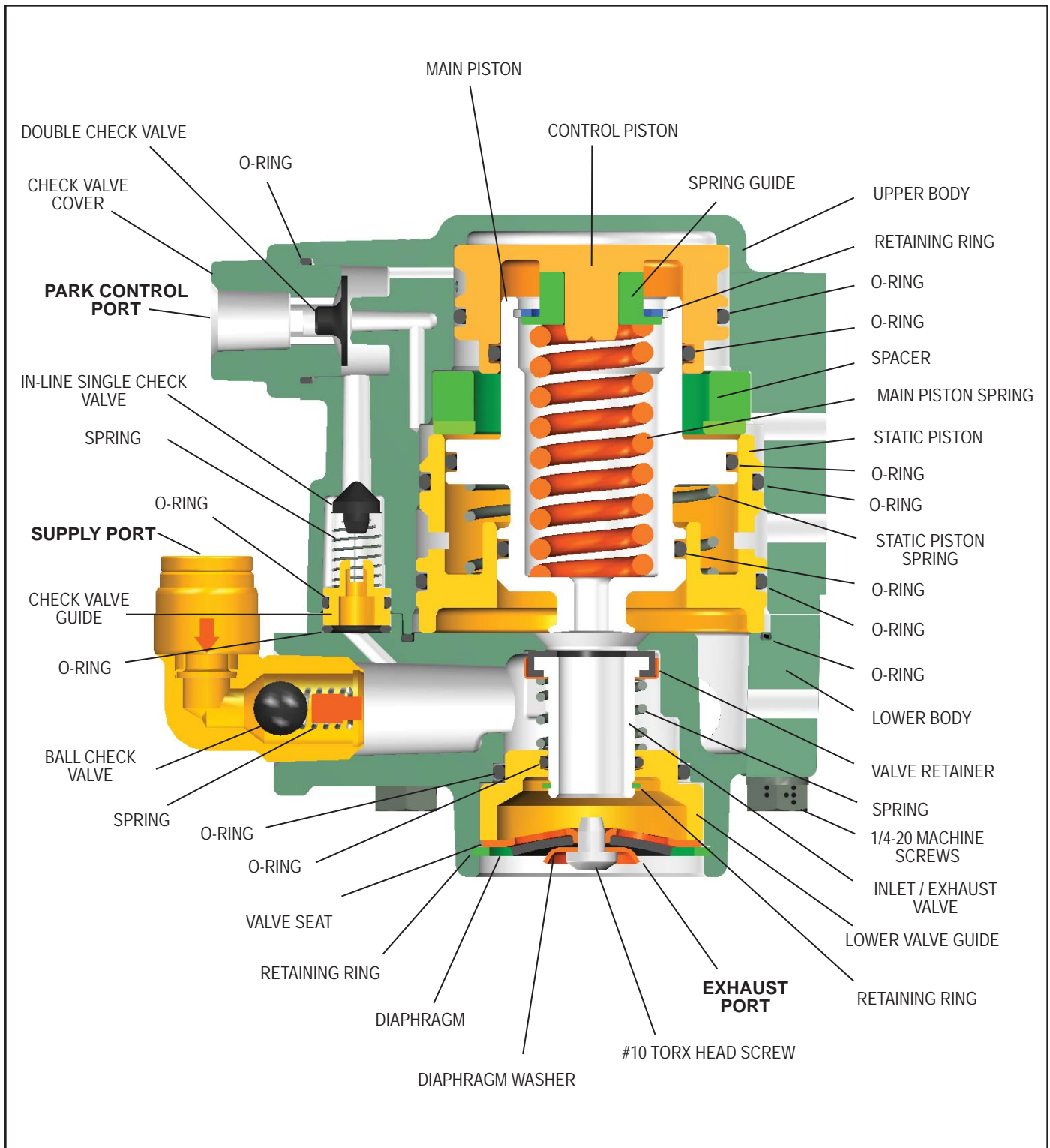

FIGURE 2 - SECTIONAL VIEW OF SR-7® SPRING BRAKE MODULATING VALVE USED IN RELAY VALVE APPLICATIONS

## OPERATION

The operation guidelines shown in this manual represent the relay valve based Bendix® SR-7® (refer to system schematic shown in figure 3). A quick release based valve functions similarly to the relay valve based version with

the exception that all air delivered to spring brakes passes through the park control port through the in-line single check valve. The SR-7® quick release style can be easily identified by the pipe plug in the supply port of the valve.

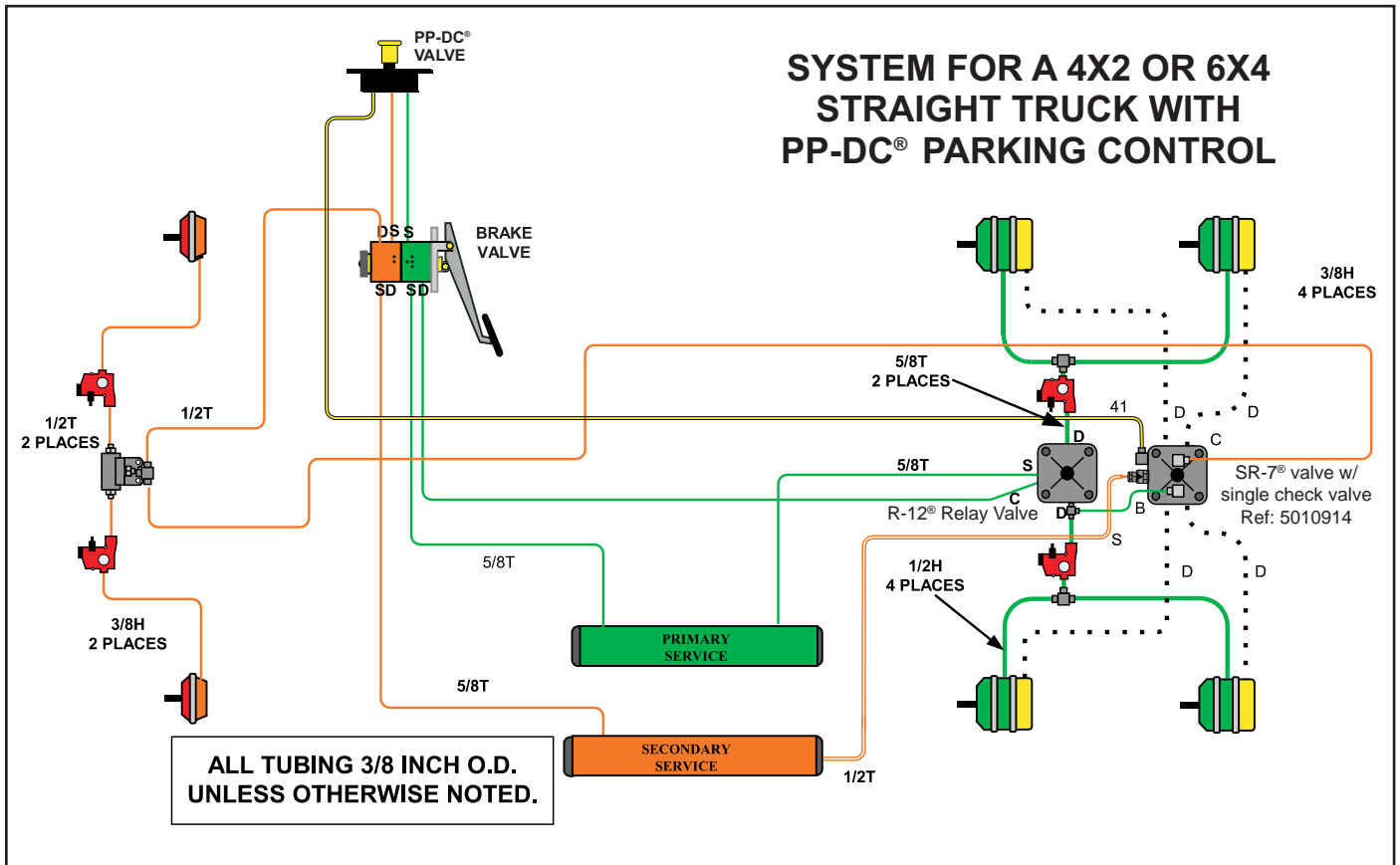

FIGURE 3 - SYSTEM SCHEMATIC WITH PP-DC® PARK CONTROL

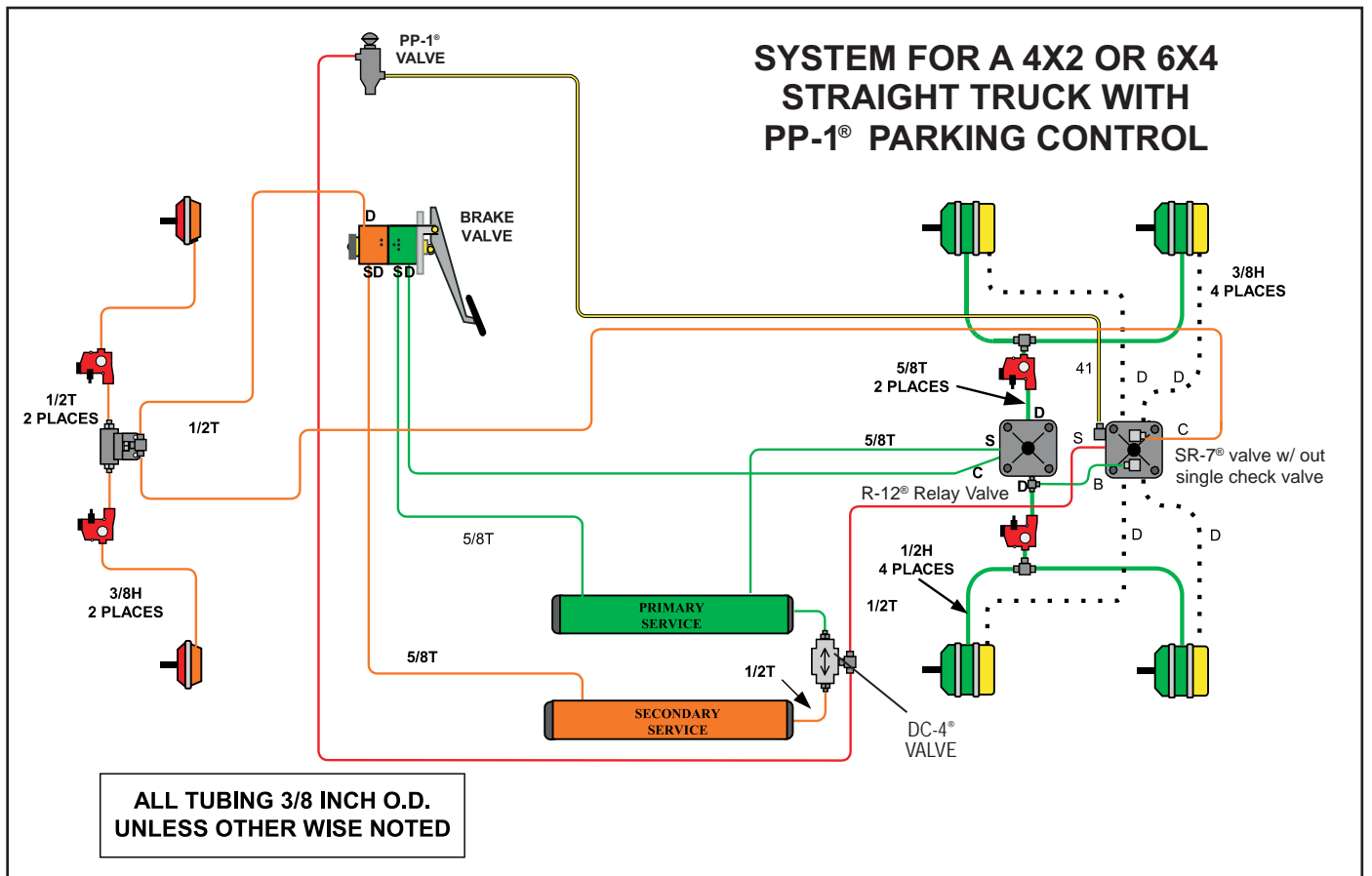

FIGURE 4 - SYSTEM SCHEMATIC WITH PP-1® PARK CONTROL AND DC-4® DOUBLE CHECK VALVE

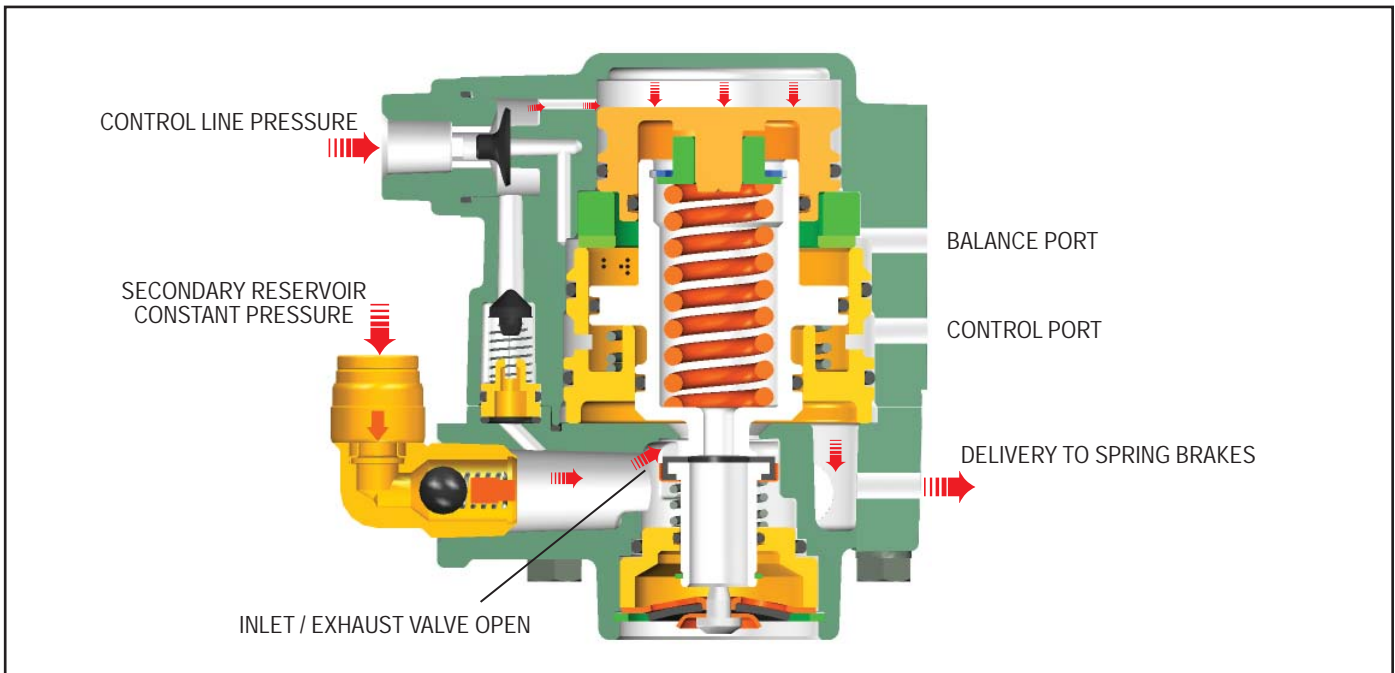

FIGURE 5 - CHARGING LESS THAN 107 PSI

**CHARGING SPRING BRAKE ACTUATORS BELOW 107 PSI (FIGURE 5)**

With the air brake system charged and the parking brakes released (by pushing the dash valve button in), air enters the park control port. This opens the Bendix® SR-7® valve to supply air pressure to the spring brake chambers. As illustrated, air pressure in the chambers is below 107 psi (nominally).

**CHARGING SPRING BRAKE ACTUATORS ABOVE 107 PSI (FIGURE 6)**

Once the SR-7® valve delivery pressure reaches 107 psi (nominal), the inlet and exhaust are closed (valve lap position). This maintains the spring brake hold-off pressure at 107 psi (nominal).

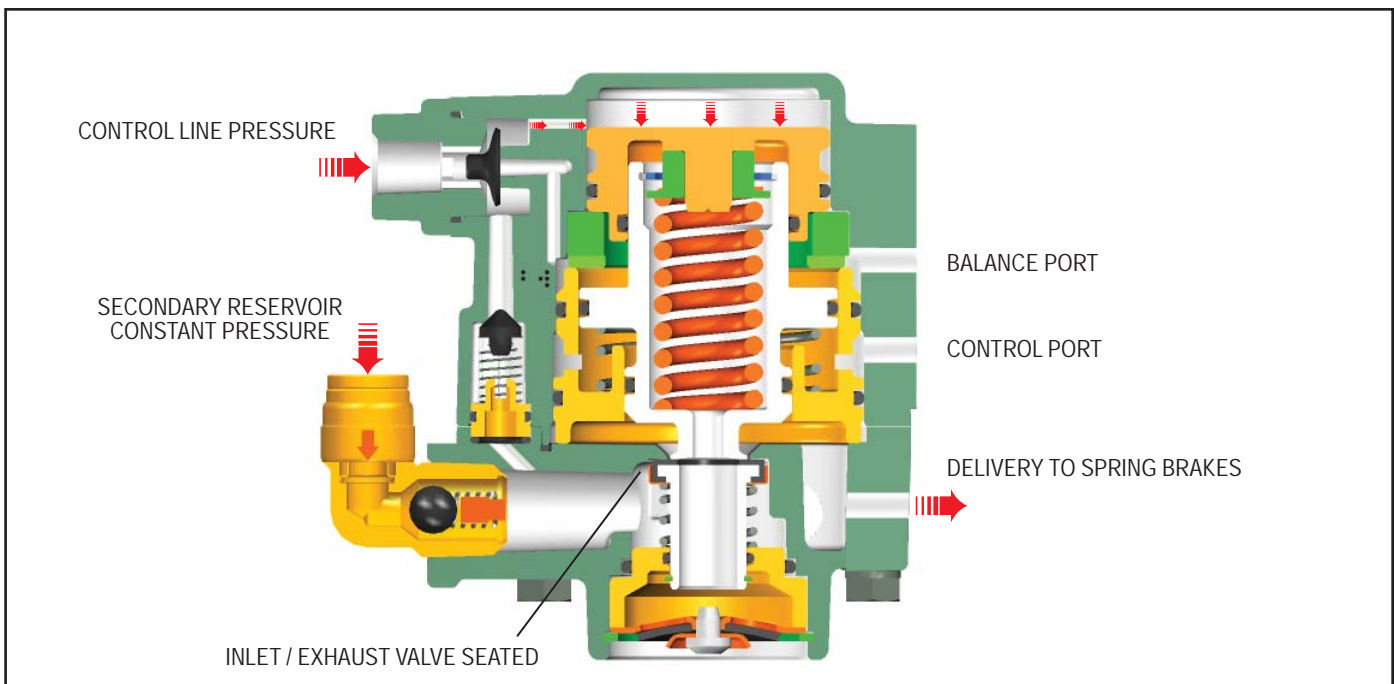

FIGURE 6 - CHARGING GREATER THAN 107 PSI

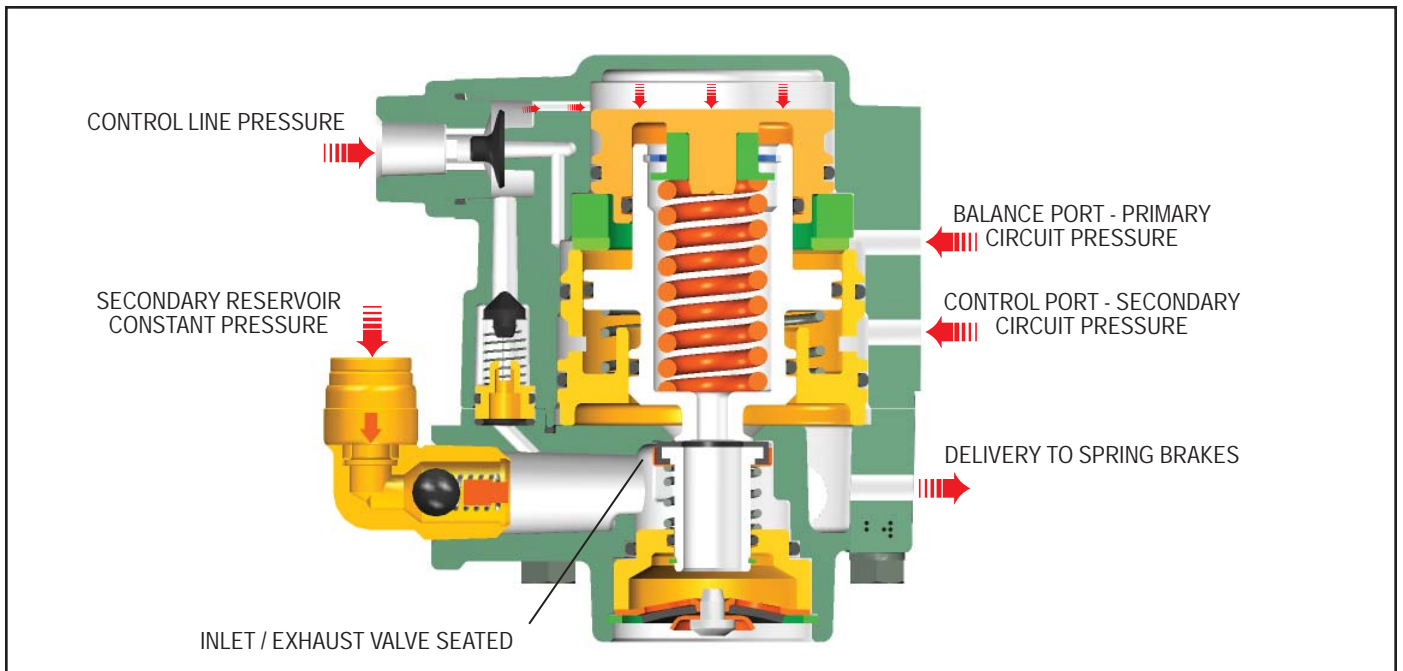

FIGURE 7 - NORMAL SERVICE APPLICATION

**NORMAL SERVICE APPLICATION (FIGURE 7)**

During a service brake application, the valve remains in the lap position. The Bendix® SR-7® valve monitors the presence of air pressure in both primary and secondary delivery circuits.

**PARKING (FIGURE 8)**

Actuating the park brakes (by pulling the dash valve button out) exhausts spring brake air pressure through the SR-7® valve exhaust port.

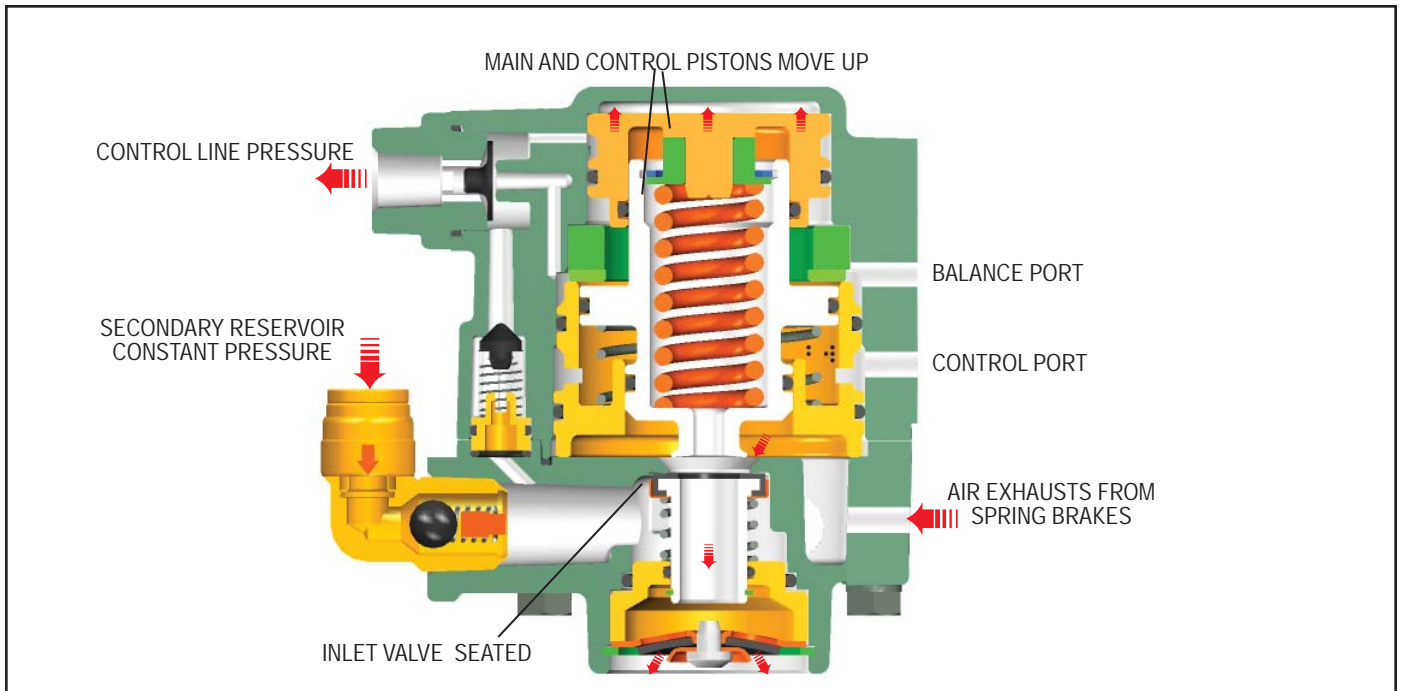

FIGURE 8 - PARKING

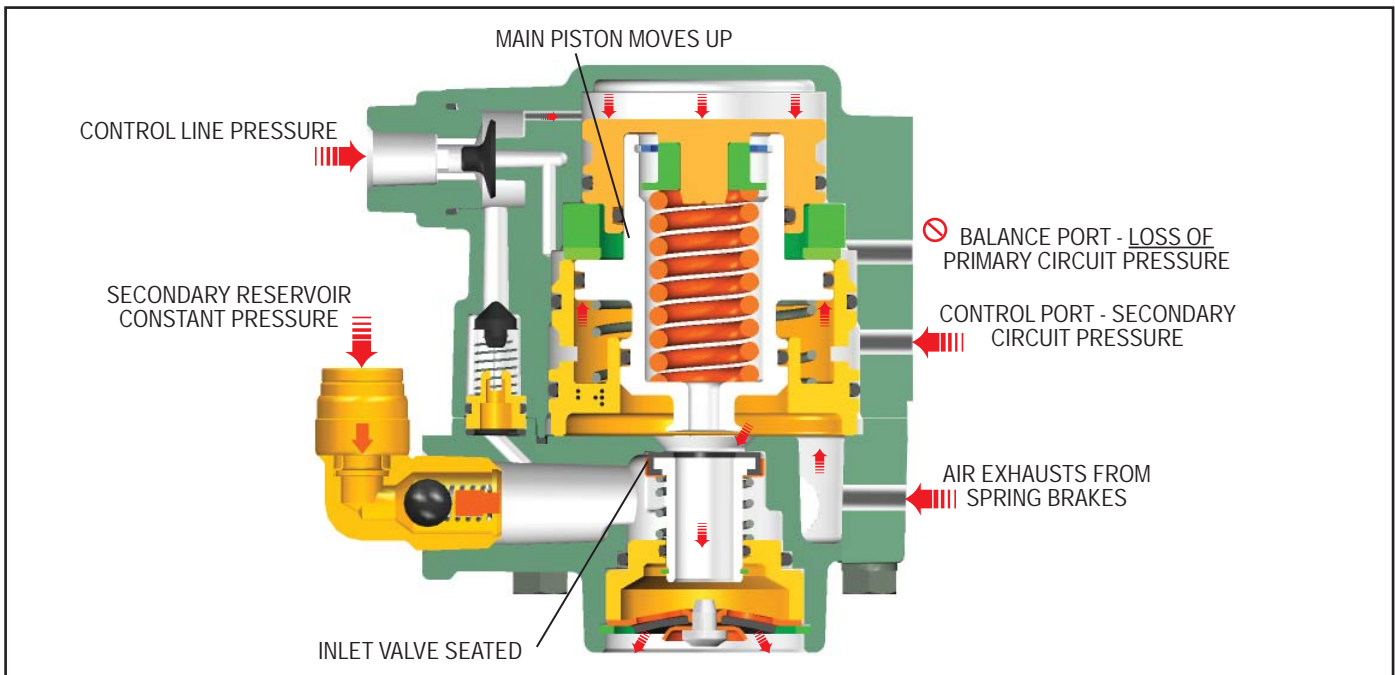

FIGURE 9 - SERVICE APPLICATION LOSS OF PRIMARY CIRCUIT

**SERVICE APPLICATION WITH LOSS OF AIR IN PRIMARY CIRCUIT (FIGURE 9)**

With the parking brakes released (dash valve button in) and the absence of air in the primary circuit delivery, a service brake application from the secondary circuit causes the pressure in the spring brakes to be exhausted proportionally to this application. This is known as spring brake modulation. A 30 psi service brake application will exhaust the spring brake pressure to approximately 60 psi.

**SERVICE APPLICATION WITH LOSS OF AIR IN SECONDARY CIRCUIT (FIGURE 10)**

With the parking brakes released (dash valve button in) and the absence of air in the secondary circuit reservoir, the external single check valve in the supply port seals to prevent air leakage to atmosphere from the Bendix® SR-7® valve. The dash valve delivery air flows through the in-line single check valve and becomes SR-7® valve supply air. This air is delivered to maintain at least 107 psi (nominal) in the spring brake chambers.

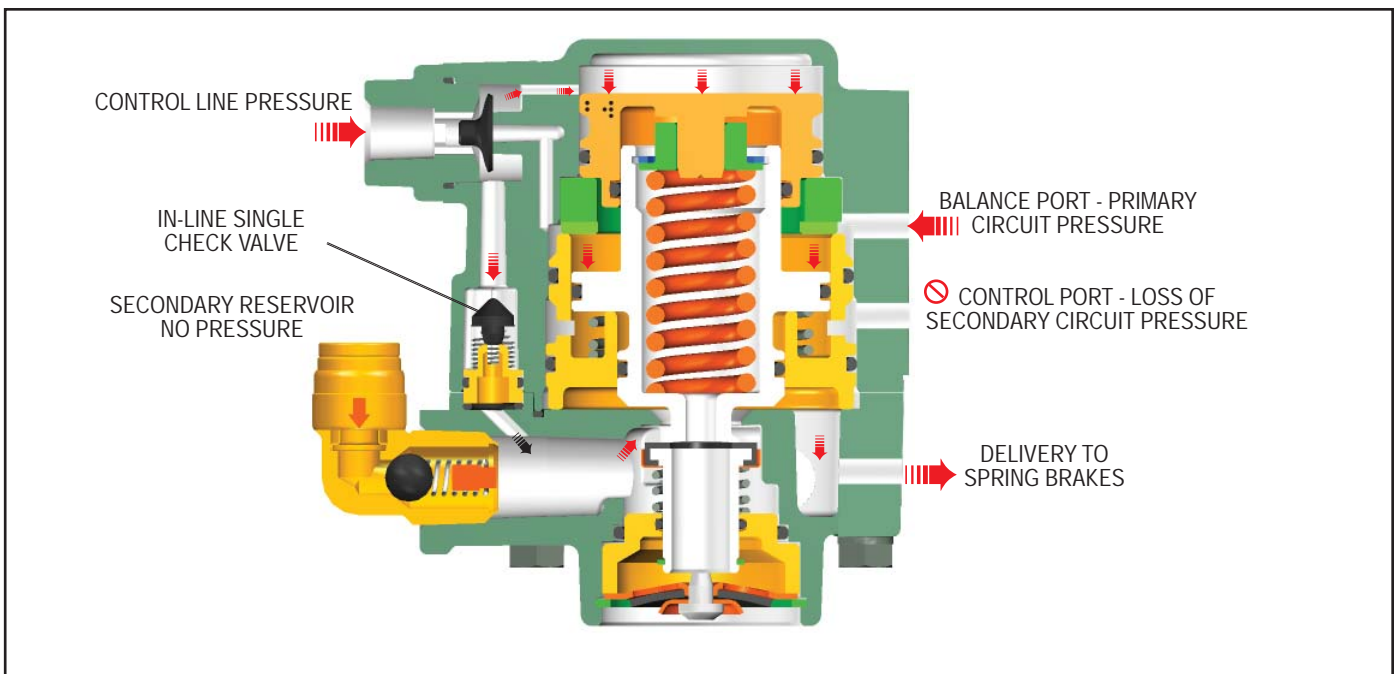

FIGURE 10 - SERVICE APPLICATION LOSS OF SECONDARY CIRCUIT

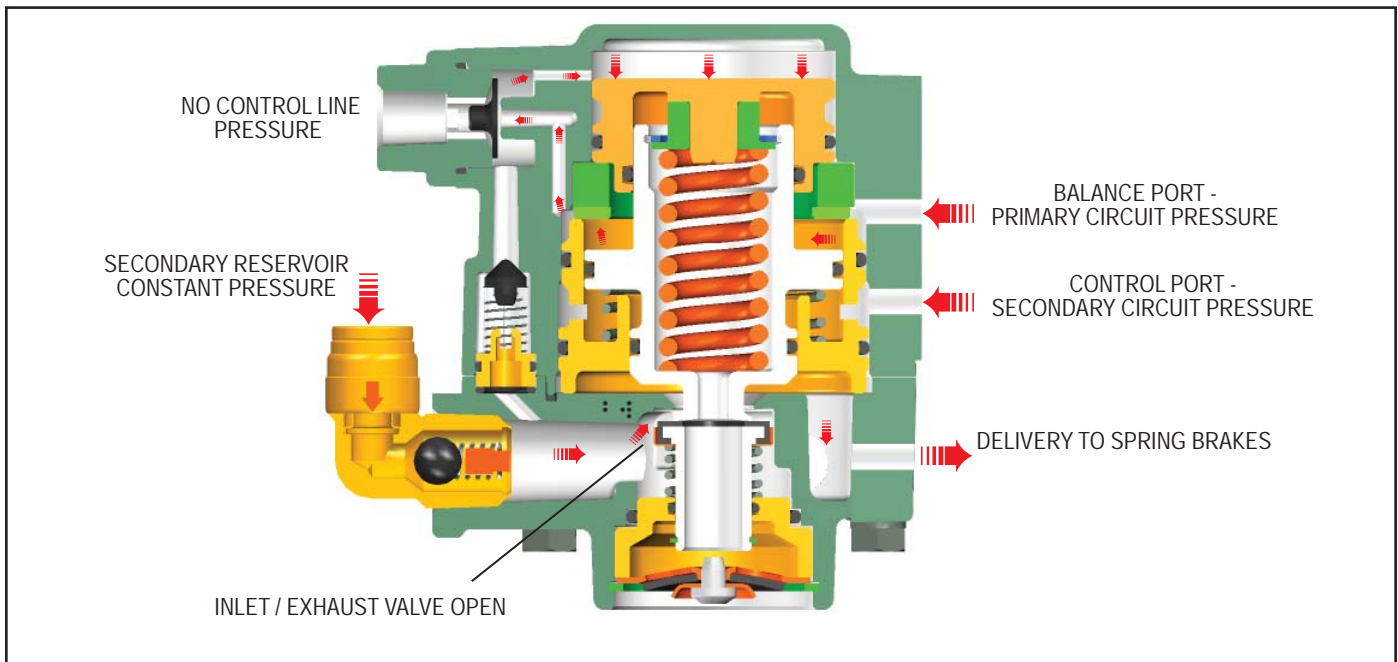

FIGURE 11 - ANTI-COMPOUNDING

### ANTI-COMPOUNDING (FIGURE 11)

The Bendix® SR-7® valve provides anti-compounding of the service and spring brake forces. When the park brakes are actuated (by pulling the dash valve button out), a service brake application will cause the SR-7® valve to deliver air pressure to the spring brake chambers. Thus the vehicle is held stationary using a service brake application. When the service brake application is released, the delivery pressure is exhausted from the spring brake chambers and the vehicle remains parked using the spring brake actuators.

### PREVENTIVE MAINTENANCE

Important: Review the Bendix Warranty Policy before performing any intrusive maintenance procedures. A warranty may be voided if intrusive maintenance is performed during the warranty period.

No two vehicles operate under identical conditions; as a result, maintenance intervals may vary. Experience is a valuable guide in determining the best maintenance interval for air brake system components. At a minimum, the SR-7® valve should be inspected every 6 months or 1500 operating hours, whichever comes first, for proper operation. Should the SR-7® valve not meet the elements of the operational tests noted in this document, further investigation and service of the valve may be required.

### OPERATING TEST

Block vehicle and hold by means other than vehicle brakes. Charge air brake system to governor cut-out pressure.

1. Place parking control valve in “park” position. Observe that spring brake actuators apply promptly. Remove one line from delivery port of the SR-7® valve and install test gauge known to be accurate. Place parking control valve in “release” position. Observe that spring brake actuators release fully.
2. With parking control valve in “release” position, note gauge pressure reading. (Correct spring brake actuator hold-off pressure is 107 psi nominally.)
3. Place parking control valve in “park” position - gauge reading should drop to zero promptly. A lag (more than 3 seconds) in drop of pressure would indicate faulty operation.
4. With the parking control valve in the “park” position, gradually apply foot brake valve and note a pressure reading increase on the gauge installed in the SR-7® valve delivery port.
5. Place parking control valve in “release” position.
6. Drain the reservoir, which supplies the rear service brake circuit, apply the foot brake valve several times and note that pressure reading on gauge decreases each time foot brake valve is applied (spring brake modulation). After the foot brake valve has been applied several times, pressure on gauge will drop to the point where release of the spring brake actuators will no longer occur.

## LEAKAGE TEST

Place the park control valve in the “release” position; using a soap solution, coat all ports including the exhaust port. A 1" bubble in 3 seconds is permitted (175 SCCM).

If the valve does not function as described, or if leakage is excessive, it is recommended that it be replaced with a new or remanufactured unit available from a Bendix parts outlet. **DO NOT ATTEMPT TO DISASSEMBLE THE SR-7® VALVE. THE VALVE CONTAINS HIGH SPRING FORCES THAT COULD RESULT IN PERSONAL INJURY IF DISASSEMBLY IS ATTEMPTED!**

## SERVICING THE SR-7® VALVE

### GENERAL SAFETY GUIDELINES

#### **WARNING! PLEASE READ AND FOLLOW THESE INSTRUCTIONS TO AVOID PERSONAL INJURY OR DEATH:**

**WHEN WORKING ON OR AROUND A VEHICLE, THE FOLLOWING GENERAL PRECAUTIONS SHOULD BE OBSERVED AT ALL TIMES.**

1. Park the vehicle on a level surface, apply the parking brakes, and always block the wheels. Always wear safety glasses.
2. Stop the engine and remove ignition key when working under or around the vehicle. When working in the engine compartment, the engine should be shut off and the ignition key should be removed. Where circumstances require that the engine be in operation, **EXTREME CAUTION** should be used to prevent personal injury resulting from contact with moving, rotating, leaking, heated or electrically charged components.
3. Do not attempt to install, remove, disassemble or assemble a component until you have read and thoroughly understand the recommended procedures. Use only the proper tools and observe all precautions pertaining to use of those tools.
4. If the work is being performed on the vehicle's air brake system, or any auxiliary pressurized air systems, make certain to drain the air pressure from all reservoirs before beginning **ANY** work on the vehicle. If the vehicle is equipped with a Bendix® AD-IS® air dryer system or a dryer reservoir module, be sure to drain the purge reservoir.
5. Following the vehicle manufacturer's recommended procedures, deactivate the electrical system in a manner that safely removes all electrical power from the vehicle.

6. Never exceed manufacturer's recommended pressures.
7. Never connect or disconnect a hose or line containing pressure; it may whip. Never remove a component or plug unless you are certain all system pressure has been depleted.
8. Use only genuine Bendix® brand replacement parts, components and kits. Replacement hardware, tubing, hose, fittings, etc. must be of equivalent size, type and strength as original equipment and be designed specifically for such applications and systems.
9. Components with stripped threads or damaged parts should be replaced rather than repaired. Do not attempt repairs requiring machining or welding unless specifically stated and approved by the vehicle and component manufacturer.
10. Prior to returning the vehicle to service, make certain all components and systems are restored to their proper operating condition.
11. For vehicles with Automatic Traction Control (ATC), the ATC function must be disabled (ATC indicator lamp should be ON) prior to performing any vehicle maintenance where one or more wheels on a drive axle are lifted off the ground and moving.

### VALVE REMOVAL

1. Prior to removing the SR-7® valve, apply the parking brakes and drain all the vehicle reservoirs.
2. Identify all air lines before disconnecting.
3. Remove the two mounting nuts that secure the valve to the frame rail and remove the valve.

### VALVE INSTALLATION

1. Align the mounting studs with the mounting holes on the vehicle frame rail. Tighten the mounting nuts to 180-220 in. lbs.
2. Install the valve onto the vehicle ensuring all ports are connected as marked during disassembly.

### TESTING THE REPLACEMENT SR-7® SPRING BRAKE MODULATING VALVE

Perform operating and leakage tests as outlined in “Operating Tests” section.