



RP700+
Interactive Flat Panel
User Manual



Disclaimer

BenQ Corporation makes no representations or warranties, either expressed or implied, with respect to the contents of this document. BenQ Corporation reserves the right to revise this publication and to make changes from time to time in the contents thereof without obligation to notify any person of such revision or changes.

Copyright

Copyright 2014 BenQ Corporation. All rights reserved. No part of this publication may be reproduced, transmitted, transcribed, stored in a retrieval system or translated into any language or computer language, in any form or by any means, electronic, mechanical, magnetic, optical, chemical, manual or otherwise, without the prior written permission of BenQ Corporation.

Table of Contents

Safety warnings and precautions	1
Important safety instructions	2
Notes on the LCD panel of this display	2
Safety notice for remote control	3
Battery safety notice	3
BenQ ecoFACTS	4
Package contents	5
Setting up the display	6
Mounting the display	6
Parts of the display and their functions	9
Front/Rear panel	9
Input/output terminals	11
Remote control	13
Using the remote control	14
Connection	15
Connecting audio/video signals	15
Connecting the touch module	20
Connecting power	21
Using the touch screen	22
Important instructions for using the touch screen	26
Basic operations	27
Turning the display on or off	27
Switching input signals	28
Adjusting audio volume level	28
The OSD (On-Screen Display) menu	29
OSD menu overview	29
Operations in the OSD menu	30
Picture menu	31
Sound menu	32
Default menu	33
Clock menu	34
Multimedia OSD operation	35
Multimedia buttons on the remote control	35

Viewing files.....	36
Product information.....	41
Specifications.....	41
Dimensions.....	43
Supported input signal resolution	44
Troubleshooting.....	46

Safety warnings and precautions



The lightning flash with arrowhead symbol, within an equilateral triangle, is intended to alert the user to the presence of uninsulated "dangerous voltage" within the product's enclosure that may be of sufficient magnitude to constitute a risk of electric shock to persons.



The exclamation point within an equilateral triangle is intended to alert the user to the presence of important operating and maintenance (servicing) instructions in the literature accompanying the appliance.

THIS EQUIPMENT MUST BE GROUNDED

To ensure safe operation, the three-pin plug must be inserted only into a standard three-pin power outlet which is effectively grounded through normal household wiring. Extension cords used with the equipment must have three cores and be correctly wired to provide connection to the ground. Wrongly wired extension cords are a major cause of fatalities.

The fact that the equipment operates satisfactorily does not imply that the power outlet is grounded or that the installation is completely safe. For your safety, if you are in any doubt about the effective grounding of the power outlet, please consult a qualified electrician.

- The mains plug of the power supply cord shall remain readily operable. The AC receptacle (mains socket outlet) shall be installed near the equipment and shall be easily accessible. To completely disconnect this equipment from the AC mains, disconnect the power cord plug from the AC receptacle.
- Do not place this display on an uneven, sloping or unstable surface (such as a trolley) where it may fall and cause damage to itself or others.
- Do not place this display near water, like a spa or pool, or in a position which will allow the splashing or spraying of water onto the display, like in front of an open window where rain water may enter.
- Do not install this display in a confined space without proper ventilation and air circulation, such as in a closed cabinet. Allow proper space around the display for dissipating heat inside. Do not block any openings and vents on the display. Overheating may result in hazards and electric shock.
- Installation of this display should only be performed by a qualified technician. Failure to install this display properly may cause injuries and damages to the personnels and the display itself. Check the installation regularly and maintain the display periodically to ensure the best working condition.
- Use only the accessories approved or recommended by the manufacturer to mount this display. Using wrong or unsuitable accessories may cause the display to fall and result in serious personal injuries. Make sure that the surface and fixing points are strong enough to sustain the weight of the display.
- To reduce the risk of electric shock, do not remove covers. No user serviceable parts inside. Refer servicing to qualified service personnel.
- To prevent personal injuries, mounting the display or installing desktop stands is required before use.

Important safety instructions

1. Read these instructions.
2. Keep these instructions.
3. Heed all warnings.
4. Follow all instructions.
5. Do not use this apparatus near water.
6. Clean only with dry cloth.
7. Do not block any ventilation openings. Install in accordance with the manufacturer's instructions.
8. Do not install near any heat sources such as radiators, heat registers, stoves, or other apparatus (including amplifiers) that produce heat.
9. Do not defeat the safety purpose of the polarized or grounding-type plug. A polarized plug has two blades with one wider than the other. A grounding-type plug has two blades and a third grounding prong. The wide blade or the third prong are provided for your safety. If the provided plug does not fit into your outlet, consult an electrician for replacement of the obsolete outlet.
10. Protect the power cord from being walked on or pinched particularly at plugs, convenience receptacles, and the point where they exit from the apparatus.
11. Only use attachments/accessories specified by the manufacturer.
12. Use only with the cart, stand, tripod, bracket, or table specified by the manufacturer, or sold with the apparatus. When a cart is used, use caution when moving the cart/apparatus combination to avoid injury from tip-over.
13. Unplug this apparatus during lightning storms or when unused for long periods of time.
14. Refer all servicing to qualified service personnel. Servicing is required when the apparatus has been damaged in any way, such as power-supply cord or plug is damaged, liquid has been spilled or objects have fallen into the apparatus, the apparatus has been exposed to rain or moisture, does not operate normally, or has been dropped.



Notes on the LCD panel of this display

- The Liquid Crystal Display (LCD) panel of this display has a very thin protective layer of glass which is liable to marking or scratching, and cracking if struck or pressured. The liquid crystal substrate is also liable to damage under excessive force or extreme temperatures. Please handle with care.
- The response time and brightness of the LCD panel may vary with the ambient temperature.
- Avoid placing the display in direct sun or where direct sun or spot lighting will shine onto the LCD panel, as the heat may damage the panel and the external casing of the display, and the bright light will make viewing the display more difficult than necessary.
- The LCD panel consists of individual pixels to display images and is manufactured according to the design specifications. While 99.9% of these pixels work normally, 0.01% of the pixels may remain constantly lit (in red, blue or green) or unlit. This is a technical limitation of the LCD technology and is not a defect.
- LCD screens, like plasma (PDP) and conventional CRT (Cathode Ray Tube) screens, are also susceptible to 'screen burn-in' or 'image retention' which can be found on the

screen as visible fixed lines and shades. To avoid such damage to the screen, avoid displaying still images (like On-Screen Display menus, TV station logos, fixed/inactive text or icons) for more than two hours. Change the aspect ratio from time to time. Fill the entire screen with the image and eliminate the black bars whenever possible. Avoid displaying images in 4:3 aspect ratio over a long period of time, otherwise there may be visible burn marks on the screen as two vertical lines.

Note: Under certain circumstances, condensation may occur on the inner side of the cover glass, it's a natural phenomenon and will not affect the operation of the display. This condensation will usually disappear after around 2 hours of normal operation.

Safety notice for remote control

- Do not put the remote control in the direct heat, humidity, and avoid fire.
- Do not drop the remote control.
- Do not expose the remote control to water or moisture. Failure to do so could result in malfunction.
- Confirm there is no object between the remote control and the remote sensor of the product.
- When the remote control will not be used for an extended period, remove the batteries.

Battery safety notice

The use of the wrong type of batteries may cause chemical leaks or explosion. Please note the following:

- Always ensure that the batteries are inserted with the positive and negative terminals in the correct direction as shown in the battery compartment.
- Different types of batteries have different characteristics. Do not mix different types.
- Do not mix old and new batteries. Mixing old and new batteries will shorten battery life or cause chemical leaks from the old batteries.
- When batteries fail to function, replace them immediately.
- Chemicals which leak from batteries may cause skin irritation. If any chemical matter seeps out of the batteries, wipe it up immediately using a dry cloth, and replace the batteries as soon as possible.
- Due to varying storage conditions, the battery life for the batteries included with your product may be shortened. Replace them within 3 months or as soon as you can after initial use.
- There may be local restrictions on the disposal or recycling of batteries. Consult your local regulations or waste disposal provider.

BenQ ecoFACTS

BenQ has been dedicated to the design and development of greener product as part of its aspiration to realize the ideal of the "Bringing Enjoyment 'N Quality to Life" corporate vision with the ultimate goal to achieve a low-carbon society. Besides meeting international regulatory requirement and standards pertaining to environmental management, BenQ has spared no efforts in pushing our initiatives further to incorporate life cycle design in the aspects of material selection, manufacturing, packaging, transportation, using and disposal of the products. BenQ ecoFACTS label lists key eco-friendly design highlights of each product, hoping to ensure that consumers make informed green choices at purchase. Check out BenQ's CSR Website at <http://csr.BenQ.com/> for more details on BenQ's environmental commitments and achievements.



Package contents

Open the sales package and check the contents. If any item is missing or damaged, please contact your dealer immediately.



LCD display

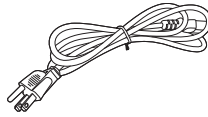

Power cord x4

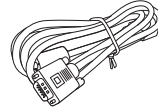

D-Sub (15-pin)
cable x1 with
two ferrite cores



Audio cable x2

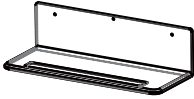

Pen tray

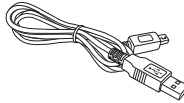

USB cable x1

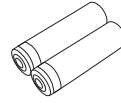

AAA battery x 2

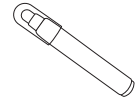

Touch pen x 2



Speaker cable x2



Remote control



Quick start guide



- The type of power cord supplied may differ from that illustrated depending on your region of purchase.
- Before discarding the package, check that you haven't left any accessories inside the box.
- Dispose of packaging materials wisely. You can recycle the cardboard carton. Consider storing the package (if possible) for future transport of the display.
- Do not leave plastic bags within reach of young children or babies.

Setting up the display

Mounting the display

You can install the display on a vertical surface with a suitable wall mounting bracket or on a horizontal surface with the optional desktop stands. Please pay attention to the following notes during installation:

- This display should be installed by at least two adult persons. Attempting to install this display by only one person may result in danger and injuries.
- Refer the installation to qualified technicians. Improper installation may cause the display to fall or malfunction.

Installing the display on a wall

1. Place a clean, dry and lint-free cloth on a flat, horizontal and object-free surface. Make sure that the size of the cloth is larger than the display.
2. Gently lay the display on the cloth with the LCD screen facing down.
3. Remove the desktop stands from the display if installed.

4. Identify the wall mounting screw holes on the back of the display as shown in the illustration.

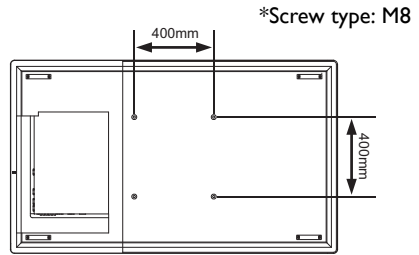

5. Install the wall mounting bracket on the display and attach the display to the wall according to the mounting bracket's instructions. The length of the screw should exceed the thickness of the wall mounting bracket by at least 10 mm. Make sure that all screws are tightened and secured properly. (Recommended torque: 470 - 635N•cm). The mounting means should be strong enough to bear the weight of the display.

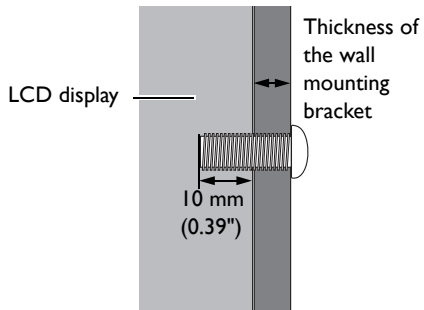



- To maintain proper ventilation, keep at least 10 mm of clear space from the back cover of the display to the wall.
- Please consult a professional technician for wall mount installations. The manufacturer accepts no liability for installations not performed by a professional technician.

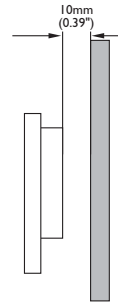

- The AC IN/OUT socket should be on top of connectors when rotating your display.

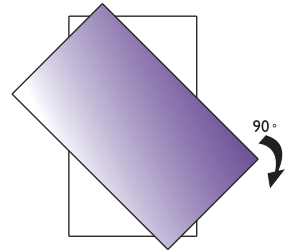

Installing the pen tray

1. Place a clean, dry and lint-free cloth on a flat, horizontal and object-free surface. Make sure that the size of the cloth is larger than the display.
2. Gently lay the display on the cloth with the LCD screen facing down.

3. Identify the wall mounting screw holes on the back of the display as shown in the illustration and remove the 3 screws on the display.

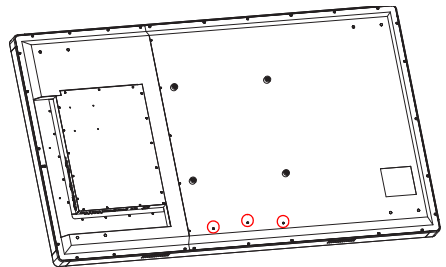

4. Place the pen tray on the back of the display as shown, and fasten the 3 screws back to the respective holes.

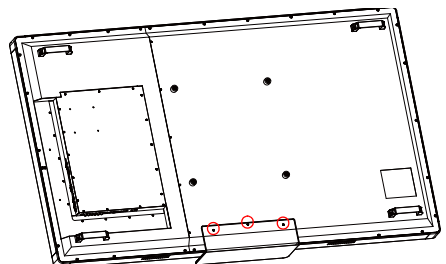

5. Lay the display straight and the pen tray is at the bottom edge of the display.

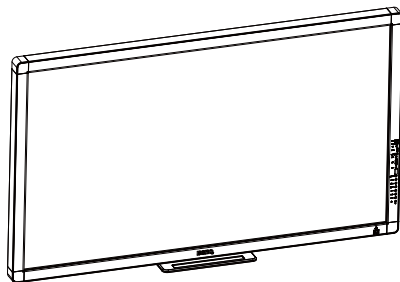

Parts of the display and their functions

Front/Rear panel

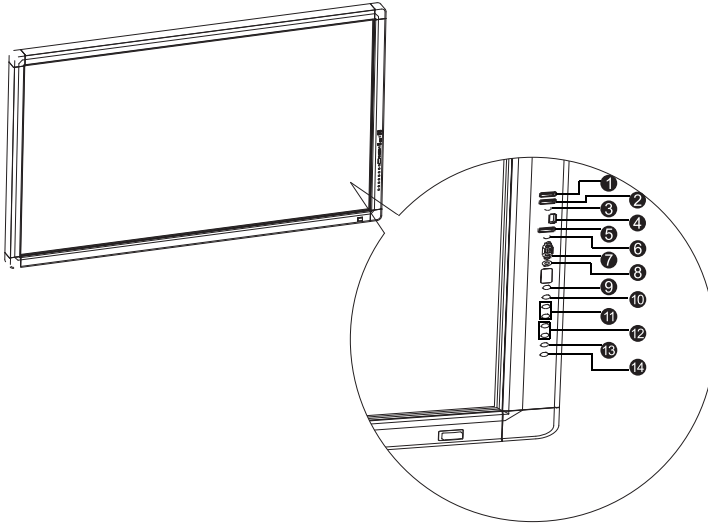

No.	Name	Description
1	PC USB	Connects to the extended USB port of computer from PC USB at back.
2	M USB	Accesses multimedia files on USB drives directly.
3	MIC	Connects to a microphone.
4	HDMI 3	Receives HDMI signals from an external device.
5	TOUCH 3	Connects the USB cable from the display to a computer to use the touch module.
6	AUDIO	Receives audio signals from an external device.
7	VGA 3	Receives analog RGB signals from an external device.
8	AV 2	Receives composite video signals from an external device.
9	INPUT/ENTER	<ul style="list-style-type: none"> • Selects/confirms options in On-Screen Display (OSD) menu. • Selects input sources.
10	MENU	<p>Opens or closes the OSD menu.</p> <ul style="list-style-type: none"> • Freezes/vacates the screen. • Scrolls through settings and options in the OSD menu.
11	FREEZE ▲/BLANK ▼	<ul style="list-style-type: none"> • Freezes the image when the OSD menu is off/Hides the image (the screen becomes blank) when the OSD menu is off.
12	◀ /-, ▶ /+	<ul style="list-style-type: none"> • Scrolls through settings and options in the OSD menu. • ◀ /-, ▶ /+: Hot keys for audio volume adjustment.

13 **MUTE** Turns off sound or restores.

14  **ON/OFF** Turns the display on or off.



TOUCH 3 must be used with HDMI 3 or VGA 3.

Input/output terminals

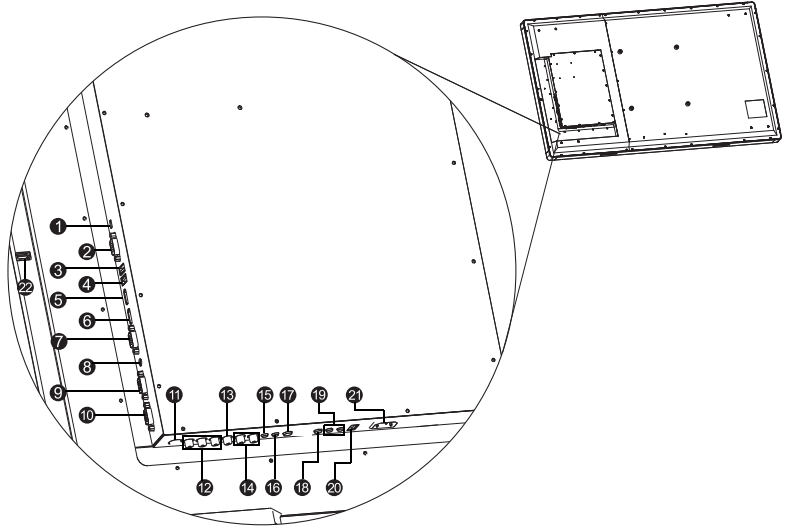

No.	Name	Description
1	PC SERVER PORT	Connects to the USB port of computer for service.
2	RS232	Receives control signals from a computer.
3	TOUCH 1	Connects the USB cable from the display to a computer to use the touch module.
4	TOUCH 2	Connects the USB cable from the display to a computer to use the touch module.
5	HDMI 1	Receives HDMI signals from an external device.
6	HDMI 2	Receives HDMI signals from an external device.
7	VGA 1	Receives analog RGB signals from an external device (such as a computer).
8	AUDIO	Receives audio signals from an external device.
9	VGA 2	Receives analog RGB signals from an external device (such as a computer).
10	VGA OUT	Outputs analog RGB signals from the VGA IN input to another display.
11	S-VIDEO	Receives S-Video signals from an external device (such as a VCR or DVD player).
12	YPbPr 1	Receives component video (YPbPr) signals from an external device (such as a DVD player, HDTV device or Laser disc player).
13	AV 1	Receives composite video signals from an external device (such as a VCR or DVD player).
14	L R	Receives audio signals from an external device that outputs video to YPbPr 1 or AV 1 .

15	YPbPr 2	Receives component video (YPbPr) signals from an external device via 3.5mm RGB component video cable.
16	AV OUT	Outputs composite video signals from the AV IN input to another display with a 3-in-1 3.5mm RCA cable.
17	SPDIF Out	Outputs digital audio signals via a coaxial cable to an external device.
18	Earphone	Connects to a headphone or an earphone.
19	Sound Box L R	Connects to external stereo speakers.
20	M USB	Accesses multimedia files on USB drives directly.
21	Power	Connects to a power outlet via the supplied power cord.
22	PC USB	Extends the USB port of computer to PC USB at front.



- TOUCH 1 must be used with HDMI 1 or VGA 1, and TOUCH 2 must be used with HDMI 2 or VGA 2.
 - Either front or back **PC USB** has to be adopted for the other functioning as a USB extender.
-

Remote control



1 POWER

Turns the display on or off.

2 INPUT

Selects an input source.

3 EXIT

Returns to the previous menu or closes the OSD menu when the OSD menu is on.

4 ◀ / VOL- / ▶ / VOL+

- Scrolls through settings and options in the OSD menu.
- Turns down/up the volume.

5 ENTER

Confirms your selection or save changes.

6 FREEZE

Freezes the image when the OSD menu is off. Not applicable to files on USB drives.

7 MUTE

Turns on or off the mute function.

8 INFO

Shows the current input source and resolution.

9 Numeric buttons (0-9) / Input source buttons

- Performs as numeric buttons when the OSD menu is on.
- Performs as input source buttons when the OSD menu is off. To select an input source as printed on top of the button, press **INPUT** and press a desired source such as **VGA**, **HDMI**, and etc.

10 MENU

Opens or closes the OSD menu.

11 ▲ CH+ / ▼ CH-

Scrolls through settings and options in the OSD menu when the OSD menu is on.

12 BLANK

Hides the image (the screen becomes blank) when the OSD menu is off. Press again to resume normal display.

13 MULTI-MEDIA buttons

See [Multimedia OSD operation on page 37](#) for details.

Using the remote control

Installing remote control batteries

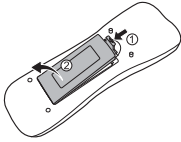

1. Open the remote control battery compartment cover.

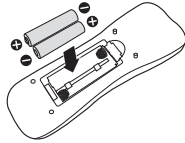

2. Insert the supplied batteries ensuring that the positive and negative marked battery terminals match the (+) and (-) marks in the battery compartment.



The supplied batteries are provided for your convenience so that you can operate the display straight away. You should replace them as soon as possible.

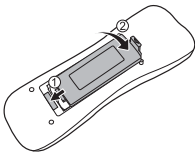

3. Refit the battery compartment cover.

Remote control usage tips

- Point and aim the top front of the remote control directly at the display's remote control sensor window when you press the buttons.
- Do not let the remote control become wet or place it in humid environments (like bathrooms).
- If the display's remote control sensor window is exposed to direct sunlight or strong light, the remote control may not operate properly. In this situation, change the light source, readjust the angle of the display or operate the remote control from a location closer to display's remote control sensor window.

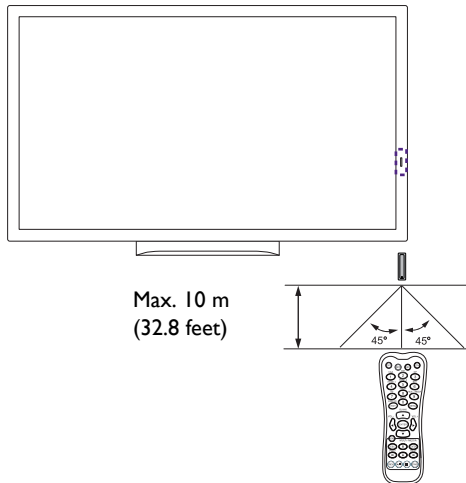

Connection

Connecting audio/video signals

Pay attention to the following notes when you connect cables:

- Please turn off all devices.
- Familiarize yourself with the audio/video ports on the display and the devices you want to use. Be aware that incorrect connections may adversely affect picture quality.
- Do not remove cables from the ports by pulling the cable itself. Always grasp and pull the connectors at the end of the cable.
- Ensure that all cables are fully inserted and firmly seated.

Connecting the VGA input

1. Connect the **VGA 1** jack on the display to the VGA output jack on a computer using a D-Sub (15-pin) cable.
2. Connect the computer's audio output jack to the **AUDIO** jack on the display using a suitable audio cable.
3. To view images from this input, press the **INPUT** button and press the **VGA** button on the remote control.

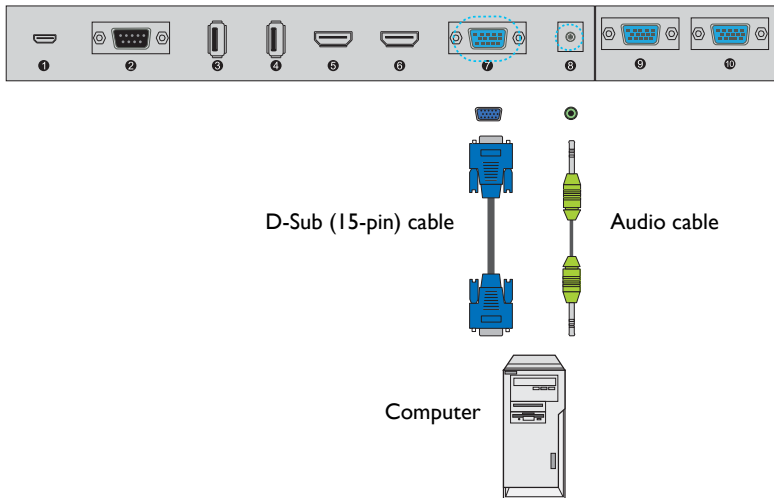

The audio cable is not supplied and should be purchased separately.

Connecting the digital inputs

1. Connect the **HDMI** output jack of a computer or A/V device (such as a VCR or DVD player) to the **HDMI 1** input jack on the display using an HDMI cable.
2. To view video image from this input, press the **INPUT** button and press the **HDMI** button on the remote control.

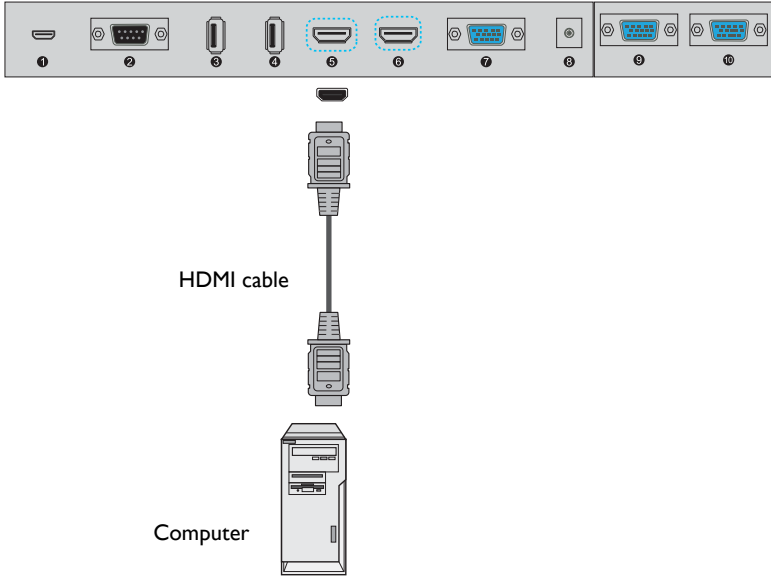

The cables are not supplied and should be purchased separately.

Connecting the YPbPr component video input

1. Connect the **YPbPr 1** jacks on the display to the component output jacks on an A/V device (such as a VCR or DVD player) using a component video cable.
2. Connect the DVD player's audio output jacks to the **L R** jacks on the display using a suitable audio cable.
3. To view video image from this input, press the **INPUT** button and press the **YPbPr** button on the remote control.

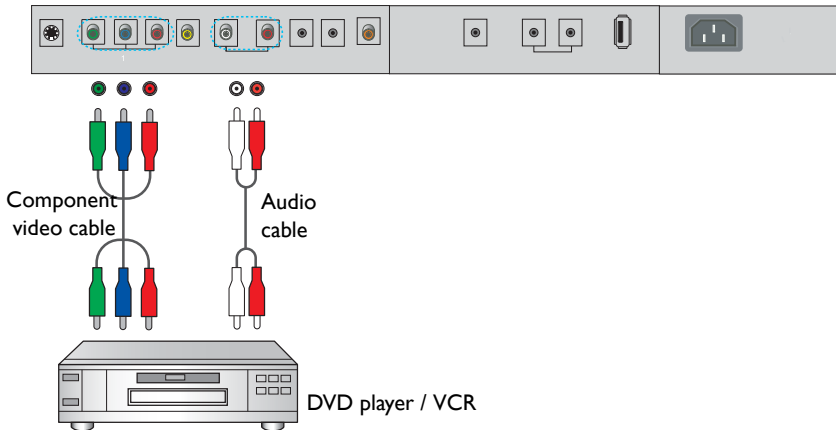

The cables are not supplied and should be purchased separately.

Connecting the AV and S-Video inputs

1. Connect the **S-VIDEO** or **AV 1** jack on the display to the output jack on an A/V device (such as a VCR) using an appropriate video cable.
2. Connect the VCR's audio output jacks to the **AV 1** jacks on the display using a suitable audio cable.
3. To view video image from this input, press the **INPUT** button and press the **AV** button on the remote control for the AV signal, or press the **INPUT** button repeatedly for the S-Video signal.

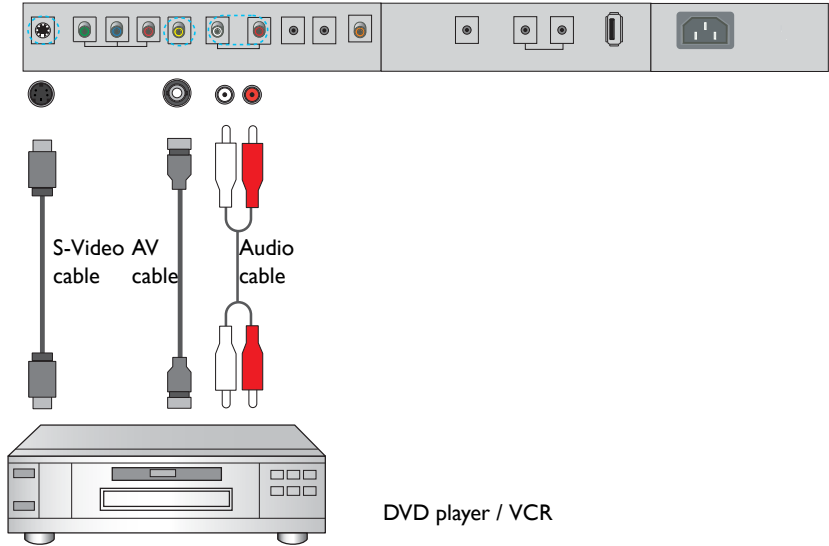

The cables are not supplied and should be purchased separately.

Connecting the multimedia inputs

To view multimedia files on the USB flash drive:

1. Plug the USB flash drive in the **M USB** port.
2. Press **INPUT** and **MULTI-MEDIA** on the remote control or select **Media** to access the multimedia OSD system. See the [Multimedia OSD operation on page 37](#) for details.

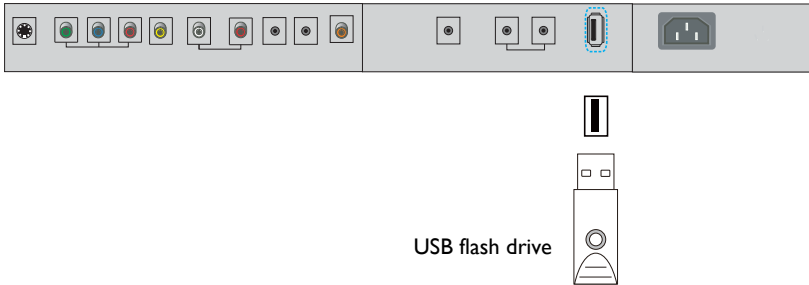

USB flash drive



The cables are not supplied and should be purchased separately.

Connecting the touch module

Connect the USB TYPE A FOR TOUCH (type A) jack (TOUCH 1, TOUCH 2, or TOUCH 3) on the display to the USB port of a computer using the supplied USB cable. The touch module of the display supports easy Plug-and-Play operation. There is no need to install additional drivers on the computer.

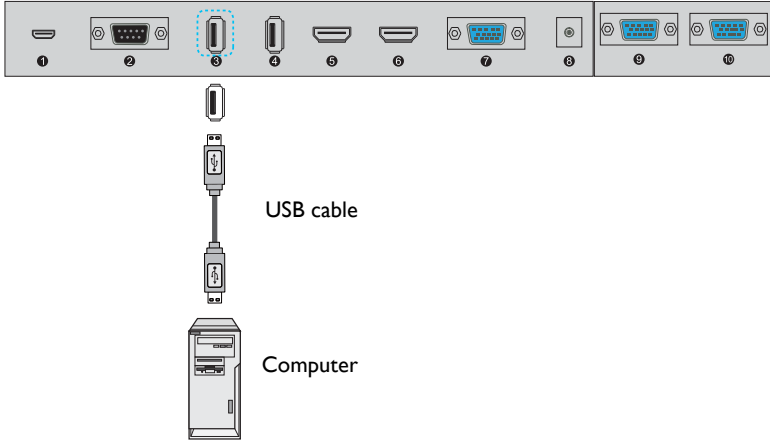

- Avoid blocking the touch screen frame (where sensors are located) when initiating the touch module.
- It is highly recommended that you connect the display to the PC or laptop directly. Avoid connecting the display to a face plate device which may cause failures in touch operations.
- If any ghost image occurs, please try to un-plug and then re-plug all USB cables. If the failure image still exists, use another USB type A to A cable.
- TOUCH 1 must be used with HDMI 1 or VGA 1, TOUCH 2 must be used with HDMI 2 or VGA 2, and TOUCH 3 must be used with HDMI 3 or VGA 3.

Connecting power

Plug one end of the power cord into the **Power** jack on the display and the other end into an appropriate power outlet (if the outlet is switched, turn on the switch).

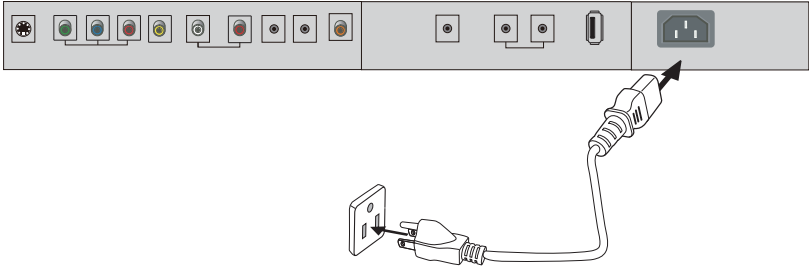

- The supplied power cord is suitable for use with 110-240V AC power only.
- The power cord and outlet illustrated may differ from the ones used in your region.
- Only use an appropriate power cord for your region. Never use a power cord which appears damaged or frayed, or change the plug type on the power cord.
- Be aware of the power loading when you use extension cords or multiple outlet power boards.
- There are no user serviceable parts in this display. Never unscrew or remove any covers. There are dangerous voltages inside the display. Turn off the power and unplug the power cord if you intend to move the display.



Using the touch screen

You can use the optical touch screen to control your operating system. The touch screen can emulate basic mouse functions and supports multi-touch functions for Windows 7/8*. The following table shows a list of gestures you can use on the touch screen.

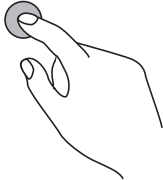
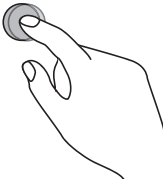
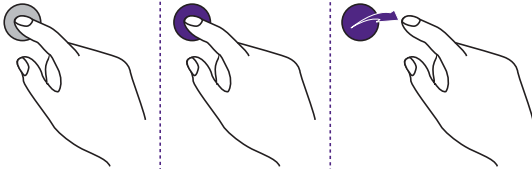
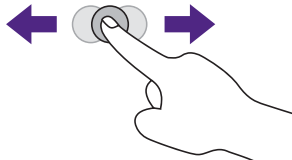

- Ensure that you have installed the USB cable on the display to a computer.
- *Multi-touch functions are only supported by Windows 8, Windows 7 - Home Premium, Professional, Enterprise and Ultimate versions. For Windows XP, Windows Vista and Windows 7 - Starter and Home Basic versions, multi-touch is not supported.
- Windows is a registered trademark of Microsoft Corporation in the United States and other countries.

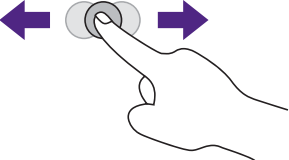
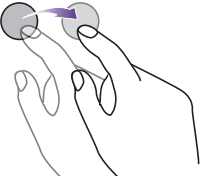
OS functions	Gesture actions
For Windows XP, Windows Vista and Windows 7	
Click	Tap the screen once. 
Double-click	Tap the screen twice. 
Right-click	<ol style="list-style-type: none"> 1. Press on the target. 2. Hold and wait for a blue ring to appear. 3. Release your finger. 
Drag	Drag one finger left or right. 

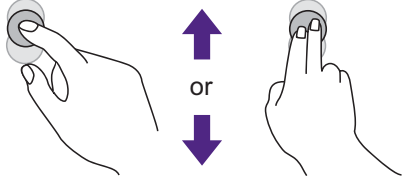
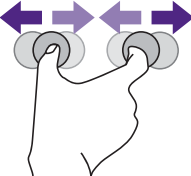
OS functions	Gesture actions
For Windows Vista and Windows 7	
Selection	<p>Drag one finger left or right.</p> 
Pan up / Pan down / Back / Forward	<p>Quickly drag your finger (Flick) in a desired direction.</p> 
Multi-touch functions	
For Windows 7 - Home Premium, Professional, Enterprise and Ultimate versions	
Right-click	<ol style="list-style-type: none"> 1. Press on the target. 2. Tap the screen with another finger. 3. Release the second finger. 
Scrolling	<p>Drag one or two fingers up or down.</p> 
Zoom	<p>Move two fingers apart or toward each other.</p> 

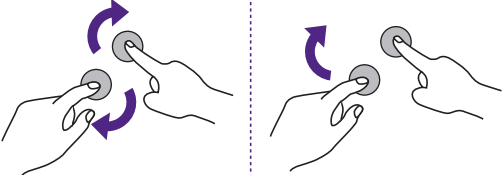
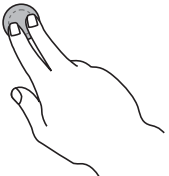
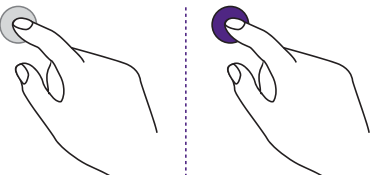
OS functions	Gesture actions
Supported by specific applications	<ul style="list-style-type: none"> • Move two fingers in opposing directions. • Use one finger to pivot around another. 
Supported by specific applications	<p>Tap two fingers simultaneously. The target should be the midpoint between the fingers.</p> 
For Windows XP, Windows Vista and Windows 7	
Wakeup from Windows sleep mode (S3)	<p>Press and hold for 4 seconds.</p> 

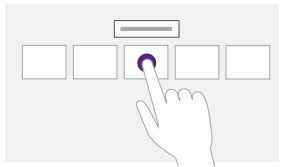
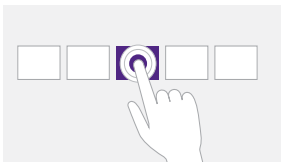
Gesture	Description
For Windows 8	
	<p>Press and hold to learn</p> <p>This touch interaction causes detailed information or teaching visuals (for example, a tooltip or context menu) to be displayed without a commitment to an action. Anything displayed this way should not prevent users from panning if they begin sliding their finger.</p>
	<p>Tap for primary action</p> <p>Tapping on an element invokes its primary action, for instance launching an application or executing a command.</p>

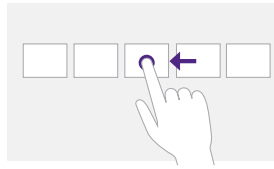
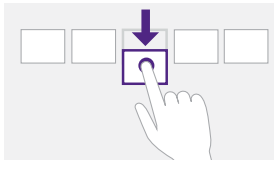
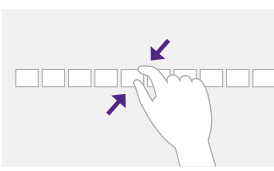
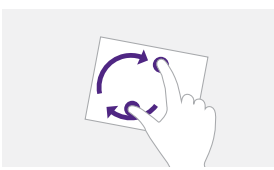
Gesture	Description
 A hand is shown sliding its index finger from right to left across a row of five square buttons. A purple arrow points to the left, indicating the direction of the slide.	<p>Slide to pan</p> <p>Slide is primarily used for panning interactions but can also be used for moving, drawing or writing. Slide can also be used to target small, densely packed elements by scrubbing (sliding the finger over related objects such as radio buttons).</p>
 A hand is shown swiping its index finger downwards over a square button. A purple arrow points downwards, indicating the direction of the swipe.	<p>Swipe to select, command, and move</p> <p>Sliding the finger a short distance, perpendicular to the panning direction, selects objects in a list or grid (ListView and GridLayout controls). Display the AppBar with relevant commands when objects are selected.</p>
 A hand is shown pinching its index and middle fingers together over a row of eight square buttons. Purple arrows point towards each other, indicating the inward movement of the fingers.	<p>Pinch and stretch to zoom</p> <p>While the pinch and stretch gestures are commonly used for resizing, they also enable jumping to the beginning, end, or anywhere within content with Semantic Zoom. A SemanticZoom control provides a zoomed out view for showing groups of items and quick ways to dive back into them.</p>
 A hand is shown turning its index and middle fingers around a square button. Purple curved arrows indicate the circular motion of the fingers.	<p>Turn to rotate</p> <p>Rotating with two or more fingers causes an object to rotate.</p>