

Connecting the AV inputs

1. Connect the **AV IN** jack on the display to the output jack on an A/V device (such as a VCR) using an appropriate video cable.
2. Connect the VCR's audio output jacks to the **AV IN** jacks on the display using a suitable audio cable.
3. To view images from this input, press the **INPUT** button on the remote control to switch to respective input source.

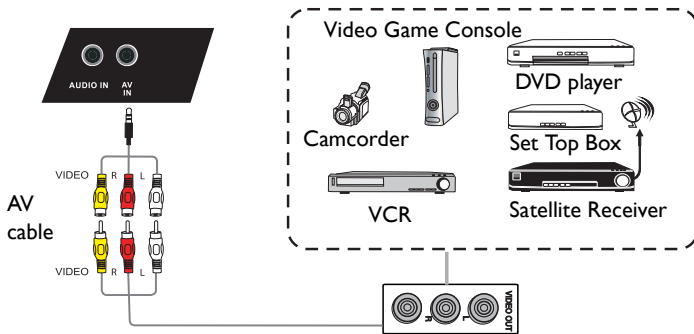

The applicable cable is not supplied and should be purchased separately.

Connecting the coaxial output

To use coaxial out for acoustic applications:

1. Use coaxial cable to connect via **COAX OUT** to your audio equipment.
2. Plug in power cord, and switch power on.

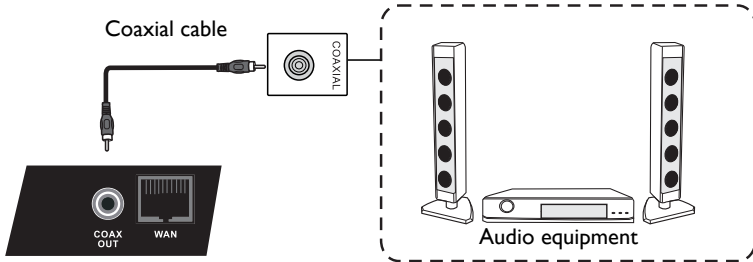

The applicable cable is not supplied and should be purchased separately.

Connecting the video output

For computer:

1. Use D-Sub cable and audio cable to connect from **VGA OUT** and **EARPHONE** to the respective jacks of the devices.
2. Plug in power cord, and switch power on.
3. Press  on the remote control to turn on the display. Press **INPUT** to switch to PC port. Set internal computer as VGA output or multi-screen display..

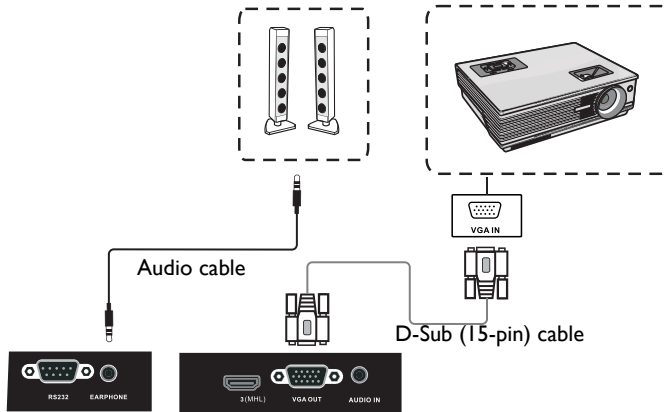

Connecting to serial port

Directly connect the computer to **RS232** ports on the input/output terminals.

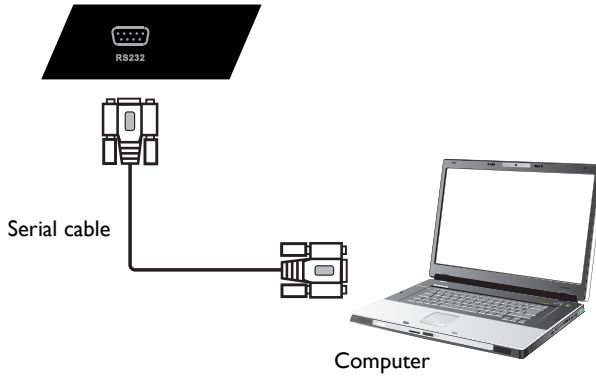

- The applicable cable is not supplied and should be purchased separately.
 - This connection is applicable to straight-through serial cables only.
 - After using serial port line to connect central control equipment and machine, certain function of the machine can be controlled via central control equipment, such as: machine on/off, and adjustment of sound volume, etc.
-

Connecting power

Plug one end of the power cord into the **Power** jack on the display and the other end into an appropriate power outlet (if the outlet is switched, turn on the switch).

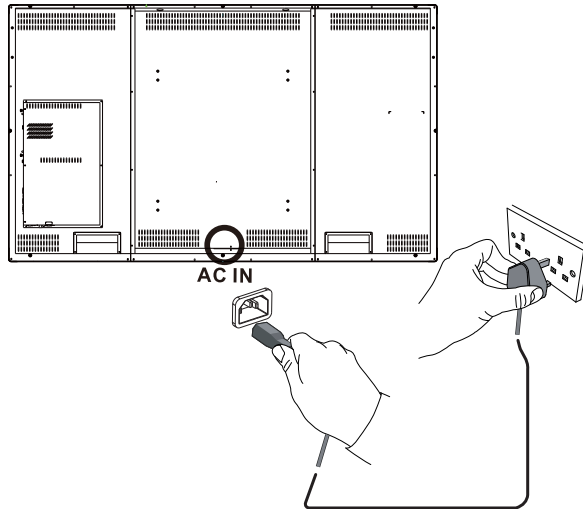

- The supplied power cord is suitable for use with 100-240V AC power only.
- The power cord and outlet illustrated may differ from the ones used in your region.
- Only use an appropriate power cord for your region. Never use a power cord which appears damaged or frayed, or change the plug type on the power cord.
- Be aware of the power loading when you use extension cords or multiple outlet power boards.
- There are no user serviceable parts in this display. Never unscrew or remove any covers. There are dangerous voltages inside the display. Turn off the power and unplug the power cord if you intend to move the display.



Using the touch screen

You can use the optical touch screen to control your operating system. The touch screen can emulate basic mouse functions and supports multi-touch functions for Windows 7/ 8*. The following table shows a list of gestures you can use on the touch screen.

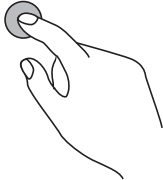
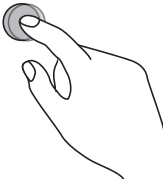
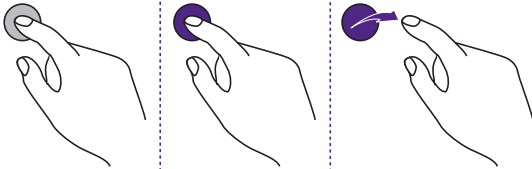
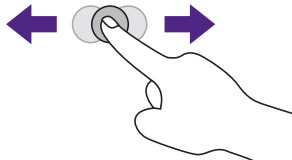

- Ensure that you have installed the USB cable on the display to a computer.
- *Multi-touch functions are only supported by Windows 8, Windows 7 - Home Premium, Professional, Enterprise and Ultimate versions. For Windows XP, Windows Vista and Windows 7 - Starter and Home Basic versions, multi-touch is not supported.
- Windows is a registered trademark of Microsoft Corporation in the United States and other countries.

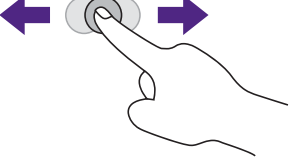
| OS functions | Gesture actions |
|---|---|
| For Windows XP, Windows Vista and Windows 7 | |
| Click | Tap the screen once.  |
| Double-click | Tap the screen twice.  |
| Right-click | <ol style="list-style-type: none"> 1. Press on the target. 2. Hold and wait for a blue ring to appear. 3. Release your finger.  |
| Drag | Drag one finger left or right.  |

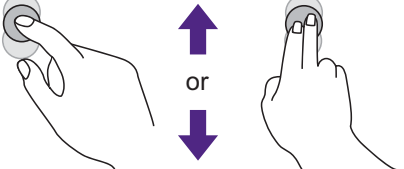
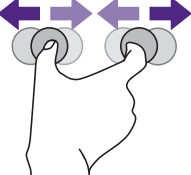
| OS functions | Gesture actions |
|--|--|
| For Windows Vista and Windows 7 | |
| Selection | <p>Drag one finger left or right.</p>  |
| Pan up / Pan down / Back / Forward | <p>Quickly drag your finger (Flick) in a desired direction.</p>  |
| Multi-touch functions | |
| For Windows 7 - Home Premium, Professional, Enterprise and Ultimate versions | |
| Right-click | <ol style="list-style-type: none"> 1. Press on the target. 2. Tap the screen with another finger. 3. Release the second finger.  |
| Scrolling | <p>Drag one or two fingers up or down.</p>  |
| Zoom | <p>Move two fingers apart or toward each other.</p>  |

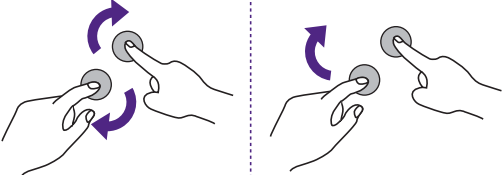
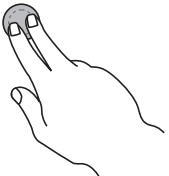
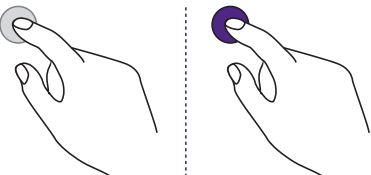
| OS functions | Gesture actions |
|---|---|
| Supported by specific applications | <ul style="list-style-type: none"> • Move two fingers in opposing directions. • Use one finger to pivot around another.  |
| Supported by specific applications | <p>Tap two fingers simultaneously. The target should be the midpoint between the fingers.</p>  |
| For Windows XP, Windows Vista and Windows 7 | |
| Wakeup from Windows sleep mode (S3) | <p>Press and hold for 4 seconds.</p>  |

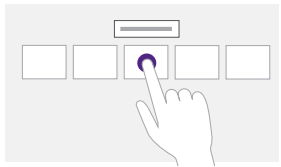
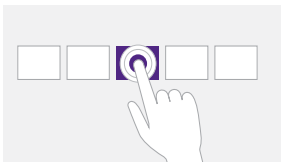
| Gesture | Description |
|--|--|
| For Windows 8 | |
|  | <p>Press and hold to learn</p> <p>This touch interaction causes detailed information or teaching visuals (for example, a tooltip or context menu) to be displayed without a commitment to an action. Anything displayed this way should not prevent users from panning if they begin sliding their finger.</p> |
|  | <p>Tap for primary action</p> <p>Tapping on an element invokes its primary action, for instance launching an application or executing a command.</p> |

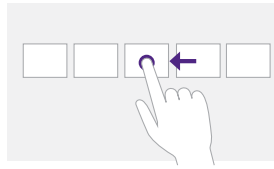
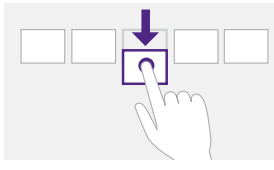
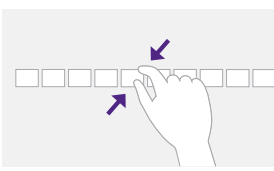
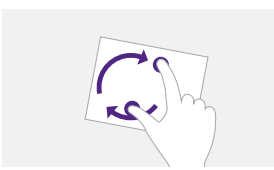
| Gesture | Description |
|---|---|
|  A hand is shown sliding its index finger from right to left across a row of five square buttons. A purple arrow above the finger points to the left, indicating the direction of the slide. | <p>Slide to pan</p> <p>Slide is primarily used for panning interactions but can also be used for moving, drawing or writing. Slide can also be used to target small, densely packed elements by scrubbing (sliding the finger over related objects such as radio buttons).</p> |
|  A hand is shown with its index finger touching the middle button of a row of five square buttons. A purple arrow points downwards from the finger, indicating the direction of the swipe. | <p>Swipe to select, command, and move</p> <p>Sliding the finger a short distance, perpendicular to the panning direction, selects objects in a list or grid (ListView and GridLayout controls). Display the AppBar with relevant commands when objects are selected.</p> |
|  A hand is shown with two fingers (index and middle) touching a row of eight square buttons. Two purple arrows point outwards from the fingers, indicating the stretching motion. | <p>Pinch and stretch to zoom</p> <p>While the pinch and stretch gestures are commonly used for resizing, they also enable jumping to the beginning, end, or anywhere within content with Semantic Zoom. A SemanticZoom control provides a zoomed out view for showing groups of items and quick ways to dive back into them.</p> |
|  A hand is shown with two fingers touching a square object. Two purple curved arrows around the object indicate a clockwise rotation. | <p>Turn to rotate</p> <p>Rotating with two or more fingers causes an object to rotate.</p> |

Important instructions for using the touch screen

Please clean the frame when there is sign of malfunction on the touch screen.

- Before you clean the screen, make sure the display is turned off, and unplug the power cord.
- Remove dust or dirt from the screen and the infrared plastic filter periodically. It is suggested using a small amount of alcohol to clean the infrared plastic filter.
- To avoid damage to the screen, never use any type of abrasive materials to wipe the screen.
- Use a neutral detergent to clean the touch screen. Avoid using detergents with erosive substance, such as banana oil or ammonia.
- Moisten a clean soft, lint-free cloth with a neutral detergent and then clean the touch screen.
- Do not spray a detergent on the screen surface or the body directly. It may result in a short circuit to the touch screen.
- Keep the touch screen out of direct sunlight or spotlights.

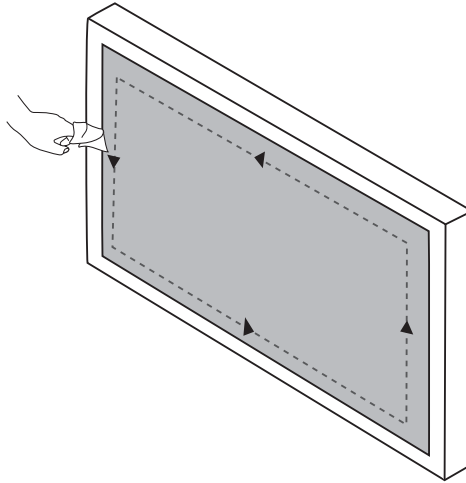

Menu operations

One touch menu operation

At the bottom middle position of the screen as the starting point, use a touch pen to drag toward center position of the screen, as shown below, to bring up the menu.

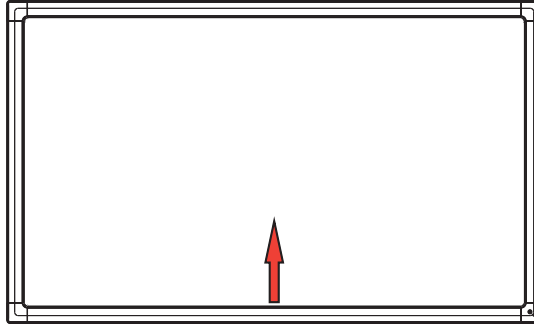

Setting menu

Input setting

Press **INPUT** on the remote control or use a touch pen dragging from the bottom middle to the center of the screen to bring the setting menu.

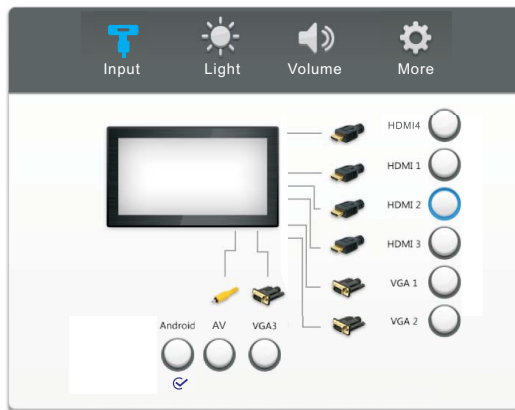

- Press **▲/▼/◀/▶** on the remote control or use a touch pen to select a desired input source and press **ENTER** on the remote control or directly click with the touch pen to confirm.
- Press **BACK** on the remote control or click blank area outside menu with the touch pen to exit menu.

Brightness setting

Press **INPUT** on the remote control or use a touch pen dragging from the bottom middle to the center of the screen to bring the setting menu.

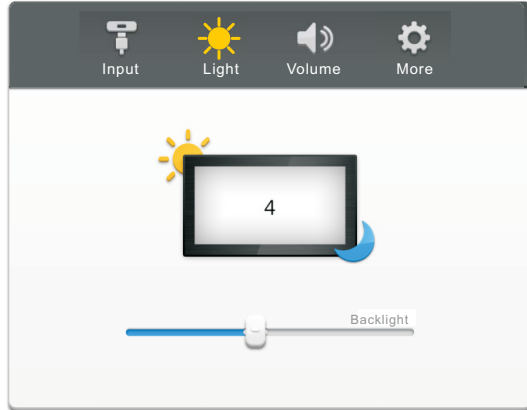

- Press **▶** on the remote control or directly click **Light** icon with touch pen to enter brightness setting menu.
- Press **◀ / ▶** on the remote control or drag brightness adjustment progress bar with the touch pen to adjust brightness.
- Press **BACK** button on the remote control or click blank area outside menu with the touch pen to exit menu.

Volume setting

Press **INPUT** button on the remote control or use a touch pen dragging from the bottom middle to the center of the screen to bring the setting menu.

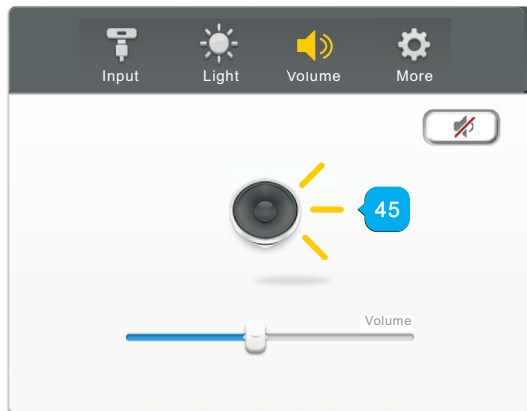

- Press **▶** on the remote control or directly click **Volume** icon with touch pen to enter volume setting menu.
- Press **◀ / ▶** on the remote control or drag volume adjustment progress bar with the touch pen to adjust volume.

- Press **MUTE** on the remote control or directly click  with the touch pen to enable or disable mute.
- Press **BACK** on the remote control or click blank area outside menu with the touch pen to exit menu.

More settings

Press **▶** on the remote control or directly click **More** icon with touch pen to enter more settings.

Android settings

When the input source is set to Android, press **INPUT** on the remote control or use a touch pen dragging from the bottom middle to the center of the screen to bring the setting menu.

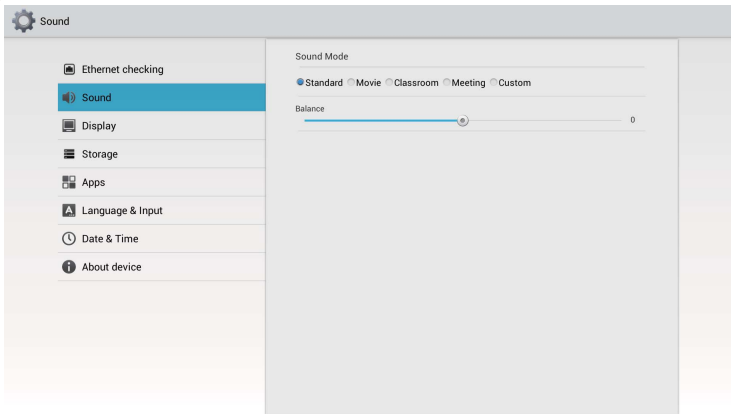

- Press **▲/▼/◀/▶** on the remote control or use a touch pen to select each option and press **ENTER** on the remote control or directly click with the touch pen to confirm.
- Press **BACK** on the remote control or click blank area outside menu with the touch pen to exit menu.

| Options | Description |
|-------------------|---|
| Ethernet Checking | To view current network status and network preferences of the display |
| Sound | To set acoustic preferences. Sound mode options are Standard, Movie, Classroom, Meeting, and Custom . Balance of sound output can be adjusted here. |
| Display | To set visual preferences on Font size and Wallpaper . |
| Apps | To view memory consumption of apps in Android. |
| Language&input | To set Language and Keyboard & Input Methods in Android. |
| Backup&reset | To restore factory settings to system in Android. |
| Date&time | To set date, time, and their formats in Android. |
| About device | To view system information in Android. |



The user applicable storage space varies from pre-installed apps and images occupancies at the total memory space.

VGA settings

When the input source is set to VGA, press **MENU** on the remote control or use a touch pen dragging from the bottom middle to the center of the screen to bring the setting menu.



- Press **▲/▼/◀/▶** on the remote control or use a touch pen to select each option and press **ENTER** on the remote control or directly click with the touch pen to confirm.
- Press **BACK** on the remote control or click blank area outside menu with the touch pen to exit menu.

| Options | Description |
|-------------|--|
| H Position | Press ◀ / ▶ on the remote control or use a touch pen to drag icon to adjust horizontal position of image. |
| V Position | Press ◀ / ▶ on the remote control or use a touch pen to drag icon to adjust vertical position of image. |
| Phase | Press ◀ / ▶ on the remote control or use a touch pen to drag icon to adjust phase position of image. |
| Clock | Press ◀ / ▶ on the remote control or use a touch pen to drag icon to adjust clock frequency of image. |
| Zoom | Press ◀ / ▶ on the remote control and press ENTER or use a touch pen to click icon to adjust display ratio of image. |
| Auto Adjust | Press ◀ / ▶ on the remote control and press ENTER or use a touch pen to click icon to automatically adjust image. |

Screen settings

When the input source is not set to Andriod, Press **MENU** on the remote control or use a touch pen dragging from the bottom middle to the center of the screen to bring the setting menu.

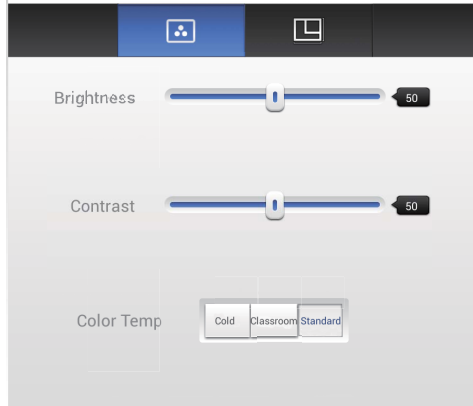

- Press **▲/▼/◀/▶** on the remote control or use a touch pen to select each option and press **ENTER** on the remote control or directly click with the touch pen to confirm.
- Press **BACK** on the remote control or click blank area outside menu with the touch pen to exit menu.

| Options | Description |
|-------------|--|
| Brightness | Press ◀ / ▶ on the remote control or use a touch pen to drag icon to adjust brightness of image. |
| Contrast | Press ◀ / ▶ on the remote control or use a touch pen to drag icon to adjust contrast of image. |
| Color Temp. | Press ◀ / ▶ on the remote control or use a touch pen to adjust color temperature of image. Options are Cold , Classroom , and Standard . |

Annotation menu

Under any input source, place two fingers with about 20~50 mm spacing on the screen for more than two seconds to bring the annotation menu as below.



The remote control is not capable of notation operations.

| Icon | Function | Description |
|------|------------------|---|
| | Annotation menu | Pop up sub-menu. |
| | Return | Click to return to previous operation interface. |
| | Main interface | Click to return to main interface of Android system. |
| | Annotation brush | Click to make annotation in the picture. Click again to change brush color. |
| | EZWrite | Click to enter writing application (EZWrite). This application supports up to 6 points simultaneous writing. Screen image will be saved automatically when exiting whiteboard software. Storage location: resource browse/blackboard writing. |
| | Resource browse | Click to open resources browse menu. |
| | Screenshot | Click for screenshot of current annotation image. Screenshot storage location: resource browse/blackboard writing. |
| | Close | Click to close annotation menu. |

Android system interface

Main interface

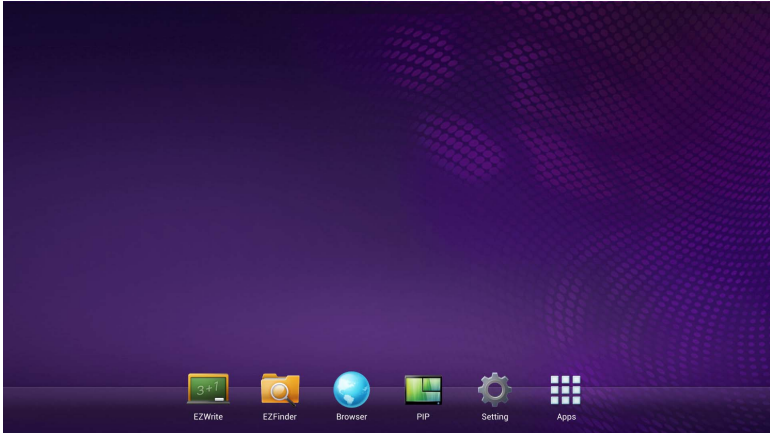







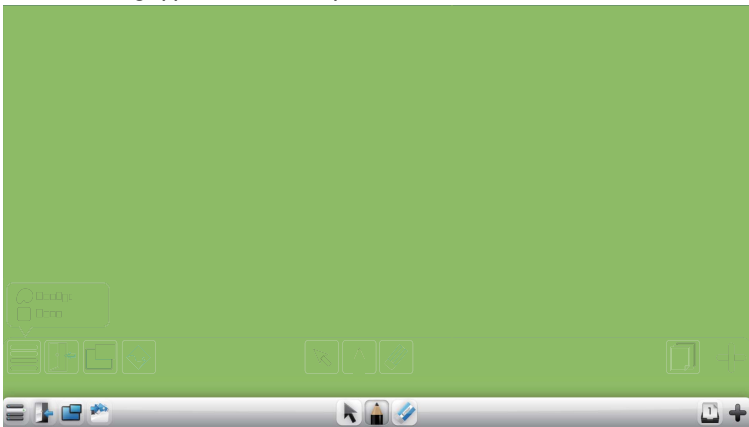



- Press ◀ / ▶ on the remote control to select icons at the bottom and press **ENTER** to execute the program, or directly tap the icon with a touch pen.
- Press **HOME** on the remote control or Home button at the bottom of front panel to return to the main interface.

EZWrite

EZWrite is a writing application for flat panels.



| Icon | Function | Description |
|---|----------|---|
|  | Menu | Click to pop up submenu (background change/save). |
|  | Exit | Click to exit the writing application. |

| | | |
|---|--------------------|---|
|  | Picture in picture | Click to pop up picture in picture interface. |
|  | Image import | Click to import required images. |
|  | Select | Click to select writing symbols. |
|  | Brush | Click to write. Press 3 seconds or more to enter setting screen to set brush color and thickness. |
|  | Eraser | Click to erase writing symbols or drag a box selection to erase. |
|  | Cancel | Click to cancel the previous operation. |
|  | Restore | Click to restore the cancelled operation. |
|  | Page | Reveal page number of the current picture. |
|  | Add page | click to add a new page of writing image. |