

Mastering Your **BERNINA®** Sergers

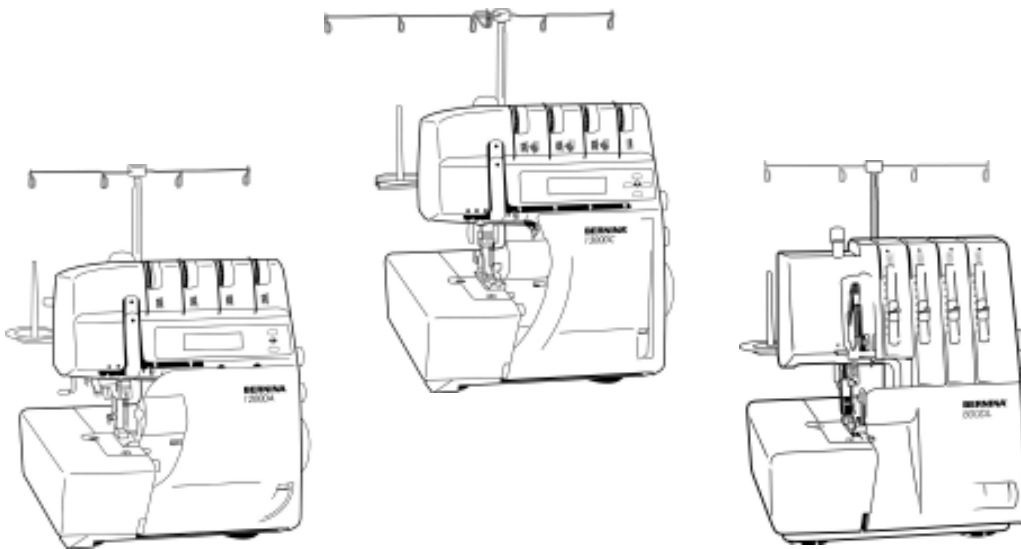

Owner's Workbook

Table of Contents

Class 1 - General Information	3
Introduction	4
Presser Feet & Accessories	5
Needles	6
Thread	8
Balanced 4-Thread Overlock	10
Adjusting Tensions	12
Stitch Length	18
Cutting Width	20
Differential Feed	22
Securing Ends	28
Serging a Tube	30
Product Reference List	32
Class 2 - Four Thread Techniques	33
Serge Seams	34
Seaming Knits	36
Serge Piecing	44
Elasticator	48
Gathering Attachment	50
Product Reference List	56
Class 3 - Three-Thread Techniques	57
3-Thread Overlock	58
3-Thread Flatlock	72
Blindstitch Foot	74
3-Thread Rolled Hem	82
Cording Foot	84
Product Reference List	88
Class 4 - Miscellaneous Techniques	89
3-Thread Super Stretch Stitch	90
2-Thread Flatlock	94
2-Thread Rolled Hem	98
2-Thread Wrapped Edge	100
Multi-Purpose Foot with Guide	102
Product Reference List	110
Class 5 - Cover & Chain	111
Coverstitch	112
Chain Stitch	124
Combination Stitches (1300 only)	130
Product Reference List	134

Class 1

General Information

Class Overview

Machine Overview

- Parts of the serger
- Setting up the serger

Serger Accessories

- Tweezers
- Lower Looper Threader (700D only)
- Needle Threader
(optional for 700D & 800DL)
- Brush/Needle Insertion Tool
- Spool Caps
- Spool Cones
- Thread Nets

Thread

- Good quality vs. poor quality
- Construction/All-Purpose Thread
- Decorative Thread

Needles

- Types of Needles
- Sizes of Needles
- Parts of Needles
- Matching Needle & Thread

Threading for Overlock Serging

- The Threading Path
- Threading Order
 - First – Upper Looper (Blue)
 - Second – Lower Looper (Red)
 - Third – Right Needle (Green)
 - Fourth – Left Needle (Yellow)
- Test Serging

Basic Serging Samples

- 1 Balanced 4-Thread Overlock
- 2 Adjusting Tensions - Loopers
- 3 Adjusting Tensions - Loopers
- 4 Adjusting Tensions - Needles
- 5 Stitch Length Adjustment
- 6 Cutting Width Adjustment
- 7 Differential Feed - Stretch
- 8 Differential Feed - Pucker
- 9 Differential Feed - Gathering & Easing
- 10 Securing Serged Seams
- 11 Serging a Tubular Project

Care & Cleaning

- Removing Lint from Inside Serger
- Oiling
- Replacing the Cutting Knives
- Yearly “Tune Up”
by Authorized BERNINA® technician

This class is formatted for owners of the following models of BERNINA® overlock machines:

- 700 D
- 800 DL
- 1100D
- 1100DA
- 1200DA
- 1300DC
- 2500DCET



Introduction

Congratulations on your purchase of a BERNINA® serger!

This workbook is designed to be used in conjunction with the Owners Classes you will take at your BERNINA® dealership, and contains a series of exercises intended to familiarize you with the features of your new BERNINA® overlock machine. In addition, you will learn about needles, threads, presser feet and accessories, all of which will increase your knowledge of serging and assist you in achieving success in all of your serging endeavors.

Once you have completed the exercises designated for your BERNINA® overlock machine, attach the sewn samples to the indicated pages and insert the pages into plastic page protectors and store them in a 3-ring binder. They can then be used as a reference tool in the future as you use your machine and explore the creative possibilities it affords you.

BERNINA® of America, Inc. strives to provide its customers not just with quality sewing and overlock machines, but with informative publications and classes. Along with providing Owners Classes, your local BERNINA® dealer stocks BERNINA® books and magazines, such as *Features*, *Serger Technique Reference Guide*, and *Through the Needle*. Plus, BERNINA® of America, Inc. has a website – www.berninausa.com – offering free projects, basic sewing and serging information, a glossary of sewing terms, inspirational stories, interviews with creative stitchers, and a variety of articles and postings that appeal to all types of stitchers, no matter which machines are their favorites.

Learn to use your BERNINA® serger to its full extent and enjoy being creative with fabric and thread!

My BERNINA® overlock machine model is: _____

I purchased it on: _____

at _____

Presser Feet & Accessories

BERNINA® Presser Feet:

- are precision engineered for specific functions
- are, in some cases, modeled after commercial feet used in factories to increase speed and production with professional looking results
- do the job intended in relation to all types of sewing (ex. garment-making, quilting, home dec, etc.)
- are supported by the best and most complete educational materials in the industry, such as the *Serging Technique Reference Guide*, *Feetures*, and the BERNINA® website at www.berninausa.com

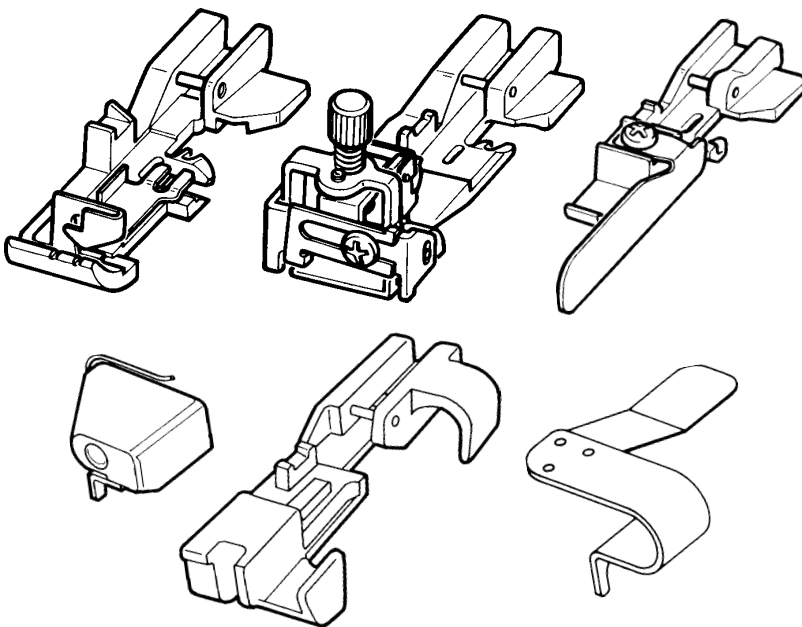

Additional Presser Feet & Accessories Available for BERNINA® Sergers:

- Blindhem Foot
- Cording Foot
- Elasticator
- Gathering Attachment
- Multi-Purpose Foot with Guide
- Standard Foot with Tape Guide
- Attachment Base
- Deco Thread Guide
- Looper/Needle Threader
- Left Seam Guide
- Right Seam Guide
- Upper Looper Converter
- Waste Collector
- *Serger Technique Reference Book*
- *Serging Made Easy!*
- *Feet-ures* Volume 2 (Unit M)
- Sophie Serges for Kids

Needles

Along with thread, needles are very important to stitch formation. Many “mechanical” problems and damage to fabrics can be traced to a bent, damaged, or incorrect size or type needle. Approximately 60% of all needles made are discarded at some stage of production. When selecting the correct needle for any serging project, three things must be considered:

Needle system – 130/705H

Needle point – to assure stitch formation and avoid fabric damage

Needle size – smaller for lightweight fabrics; larger for heavier ones

If the needle is:

Too small – the thread can't stay in the groove to form a loop to be picked up by the looper

Bent – thread loop forms too far away from looper, which can't enter loop to form stitch

Blunt – needle won't pierce fabric so no thread loop forms to make a stitch

Need To Know

- **Never use a needle bigger than size 90/14** in your serger; larger needles can interfere with looper movement and cause damage.
- Needle should be changed every 4-6 hours of sewing. The needle is the most inexpensive part in your serger but is one of the most crucial for getting good results and keeping your machine running well. Don't let false economy keep you from doing what is best for your sewing projects and your machine.
- European needles are chrome-plated to glide through fabric easily.
- The selected thread should fit in the groove on the front of the needle. If it isn't protected by the groove, a needle with a larger groove should be used.
- Always make sure needles are fully inserted as high as possible, with the flat side to the back.

Needle Size Conversion

European vs. Domestic

60 = 8	90 = 14	Regardless of the system, the greater
70 = 10	100 = 16	the number, the larger the diameter
75 = 11	110 = 18	of the needle. Never use a needle
80 = 12	120 = 19	larger than size 90/14 in your serger!

Notes

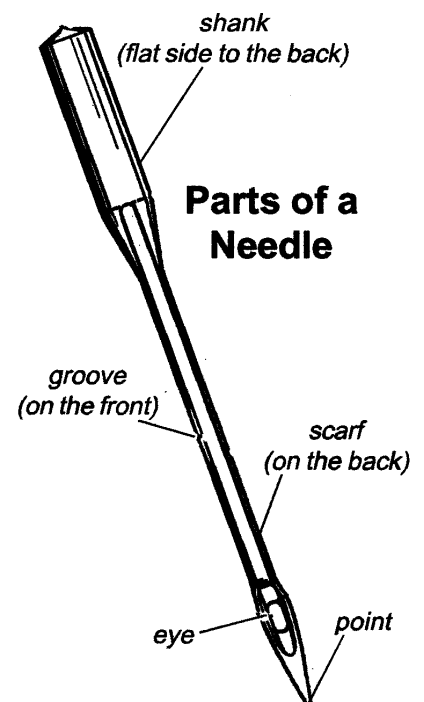

Needle Chart

Never use a needle bigger than size 90/14 in your serger;
larger needles can interfere with looper movement and cause damage.

Ball Point	70-90	Has a rounded point. 70 for lingerie, nylon, jersey; 80 for T-shirt; 90 for sweatshirt fleece.
Stretch	70-90	A stretch needle has a more rounded point and a blue anti-cling coating which helps to prevent skipped stitches in knits and elastic. Sometimes used on Ultrasuede®, vinyl, and plastic.
Universal	60-90	A compromise between a sharp and a ballpoint needle; can be used on both wovens and knits. 60 – very fine batiste 70 – broadcloth 80 – trigger and gabardine 90 – denim and twill
Jeans	70-90	Has a sharp point and a shaft that is less prone to flex. The sharpness of the needles makes it better for use on denim and woven fabrics where a clean stitch is desired.
Microtex Sharp (Schmetz)	60-90	A sharp point with a thin shaft. 60-90 corresponds to the weight of the fabric; as the fabric gets heavier or denser, the number is higher. Specially designed for microfiber fabrics.
Microfiber (Lammertz) Quilting	assort'd (75 & 90)	The thin, tapered point of this needle causes less damage to fabric when seaming and cross seaming.
Topstitch	80-90	A sharp point with a large eye and deep groove. Use with heavier fabrics – the large groove cradles heavy threads.
Embroidery (Schmetz) Metafil (Lammertz)	75-90	Sharp needle with a large eye and groove; also has a coating and a larger scarf. For use with embroidery thread – prevents shredding of rayon or metallic threads. Two threads may be used through the eye of an 80 or 90 needle.
Leather	80-90	Point is a sharp cutting wedge. <i>Used for leather only.</i> Not for vinyl or simulated leathers.

Thread

Poor quality or the wrong type of thread can cause poor stitches on any machine. Thread passes through the eye of the needle approximately 37 times in a “seesaw” action before it forms a single stitch. Poor quality thread results in crooked and looped stitches, puckered seams, frayed thread, and/or needle breakage. To achieve quality stitches, an overlock machine needs three things: correct thread, correct size needle, and properly adjusted settings.

Several factors such as the fiber, twist, ply, finish, and size of thread must be considered for use with today’s fabrics for fine stitches.

Staple – refers to the length of fibers used to twist together to form a single ply. Domestic thread fiber lengths are usually 1½” to 2½” long while European threads use 5½” to 6½” lengths.

Ply – number of strands twisted together to make a single thread.

Roll – the tendency of thread to roll to the right or left during stitching, causing the stitch to appear slightly crooked. Poor quality threads are more likely to roll.

Twist – the crimping of fibers which causes them to interlock firmly into a single ply. Thread should not untwist during stitching. This will cause skipped stitches, thread breakage, crooked stitches, and weak spots in seams.

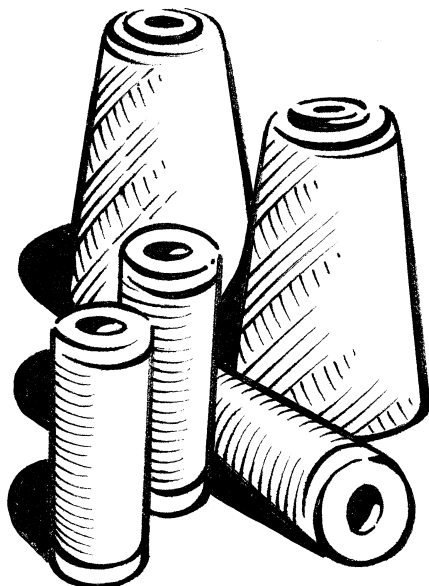

Right twist – most American threads are twisted to the right, causing some rolling. This gives average stitch quality.

Left twist – Most commercial and imported threads are twisted to the left, giving better than average stitch quality. Left twist resists rolling and makes a larger loop for the hook point to enter, reducing skipped stitches.

Notes

Thread

Wearable art embellishment has necessitated the creation and marketing of many new thread types, such as rayons and metallics. Threads made in West Germany are left twist threads; Mettler and Isacord threads are also left twist. To test the twist of a thread: while holding the spool in the left hand, roll the strand of thread towards you with one thumb. Left twist will tighten, right twist will loosen.

Fiber – refers to the type of material used to produce the thread. Some commonly used threads:

- *Polyester Overlock Thread* – such as Mettler Metrocor Thinner than regular sewing thread, eliminating bulk in serger stitch formations. An excellent all-purpose serger thread.
- *Texturized Nylon Thread* – such as YLI Woolly Nylon and Mettler Metroflock. A very elastic thread with excellent coverage; perfect for rolled edges and knit seams. Available in solid and variegated colors, and metallics.
- *Polyester Topstitching Thread* – such as YLI Jeans Stitch & Mettler Cordonnet – this heavy thread is used for decorative stitching, such as flatlocked seams and overcast edges. Also nice for cover and chain stitching. Available in solid and variegated colors.
- *Rayon Decorative Threads* – such as YLI Pearl Crown Rayon & YLI Designer 6 – shiny threads for decorative applications. Pearl Crown Rayon is twisted, while Designer 6 is untwisted. Available in solid and variegated colors.
- *Metallic Decorative Threads* – such as YLI Candlelight – adds a bit of glitz to seams and edgings.
- *Decorative Sewing Threads* – sewing machine threads can also be used in the serger, and are particularly effective when several are used together as one thread.

Storage of Thread

Thread does wear out and should be stored with care to keep it usable as long as possible. Extreme moisture may cause thread to swell while very dry conditions can leave it dry and brittle as it ages. Store thread in a covered container (thread box with a lid, cabinet with doors, or drawers that close) if possible to keep it dust-free.

Be wary of old spools of thread recovered from Grandma's sewing box. The fibers may be so weak and brittle that even if it sews into a seam, it may be so unstable that the garment or project will not hold together and the life of the project may be considerably shortened.

Notes

Balanced 4-Thread Overlock

Fabric firm fabric, 6" x 6"
 Needle 80/12 Universal
 Thread 4 cones of serger thread
 (yellow, red, green, blue)
 Presser Foot standard
 Stitch 4-thread overlock

Notes

Thread the serger for a 4 thread overlock stitch using thread colors to match the color-coded threading path on the serger.

Adjust all thread tension settings as indicated.

Fold the fabric in half to 3" x 6".

To begin stitching, lift the front of the presser foot with your right thumb and slide the fabric under the presser foot. Release the tip of the presser foot and begin serging.

Serge to the end of the fabric. Continue stitching off the fabric until you have a 3"- 4" thread chain. Cut thread chain.

Examine the serger stitch formation and compare it to the balanced stitch graphic on page__ of your Owner's manual.

Read the information under *Adjusting the Thread Tension* on page__ of the Owner's manual for information about the stitch formation and correcting any stitch irregularities.

Make any necessary tension adjustments and serge another row of stitching.

Trim and mount the sample.

Record your serger's "personal" tension settings for a balanced overlock in the chart below:

Balanced 4-Thread Overlock

Upper Looper	Lower Looper	Left Needle	Right Needle

Balanced 4-Thread Overlock Sample

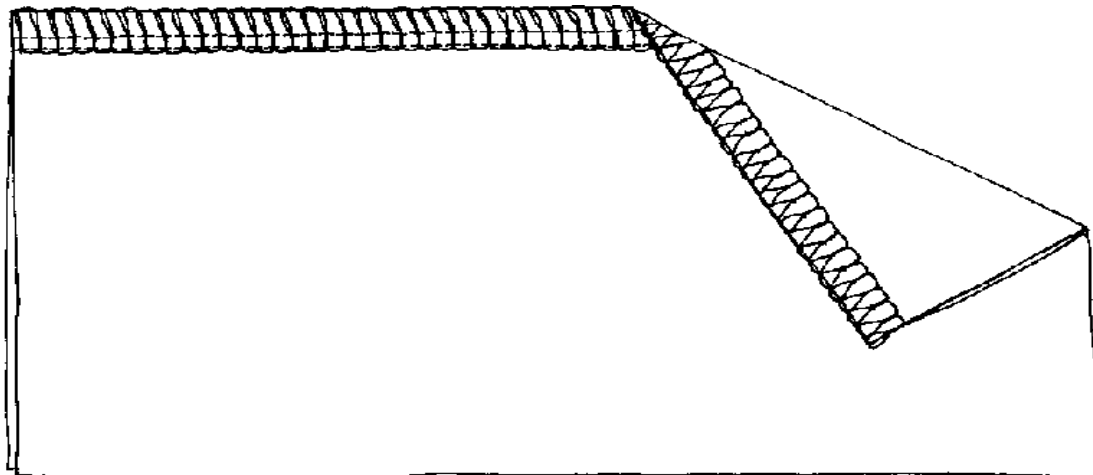

Balanced 4-Thread Overlock

Upper Loper	3-5	Cutting Width	2-3
Lower Loper	3-5	Stitch Length	2.5mm
Left Needle	3-5	Differential Feed	N
Right Needle	3-5	Rolled Edge Lever	in

Adjusting Tensions

Fabric	6 pieces firm fabric, each 3" x 6"
.....	1 piece of lightweight cotton, 3" x 4"
Needle	80/12 Universal
Thread	4 cones of serger thread
.....	(yellow, red, green, blue)
Presser Foot	standard
Stitch	4-thread overlock

Lower Looter - Increased Tension

Thread the serger for a 4-thread overlock stitch using thread colors to match the color-coded threading path on the serger.

Fold each piece of the firm fabric to 1½" x 4" and set aside.

Locate the thread tension levers on the front of the serger. From left to right, these levers adjust tension for the Left Needle, Right Needle, Upper Looter, and the Lower Looter.

Adjust the lower looper thread tension lever to 7 to increase the tension on the looper thread.

Place the first piece of folded fabric under the presser foot with the fold to the right and serge to the end of the fabric, cutting off the fold.

Examine the sample. The looper threads do not lock on the edge of the fabric. The upper looper thread is pulled tightly to the back of the stitch. The left needle thread may be pulled to the back of the stitch.

Trim, label, and mount the sample.

Lower Looter - Decreased Tension

Change the lower looper thread tension lever to 2 to decrease the tension on the looper thread.

Serge the second piece of folded fabric, cutting off the fold.

Examine the sample. The looper threads do not lock on the edge of the fabric. The lower looper thread is visible on the face of the fabric. The looper threads are very loose.

Label, trim, and mount the sample. Return the thread tension levers to normal.

Notes

Adjusting Tensions Samples

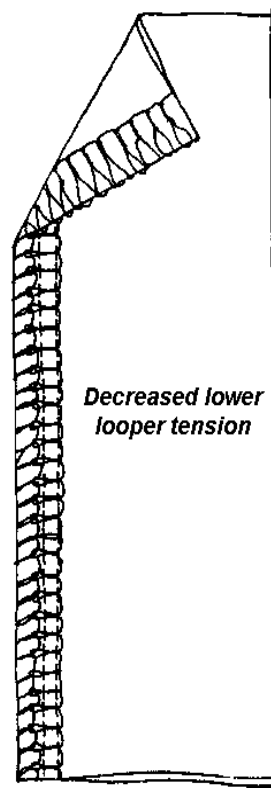
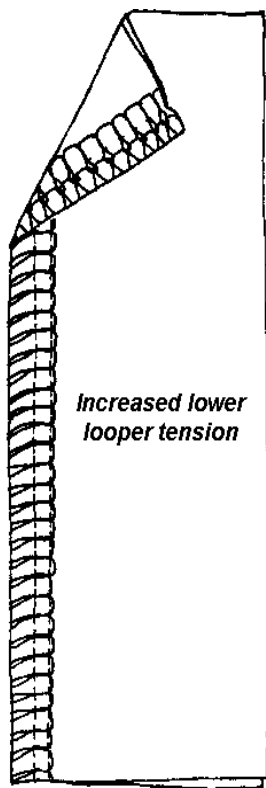

Balanced 4-Thread Overlock

Upper Looper 3-5
Lower Looper 3-5
Left Needle 3-5
Right Needle 3-5

Cutting Width 2-3
Stitch Length 2.5mm
Differential Feed N
Rolled Edge Lever in

Adjusting Tensions, continued

Upper Looper - Increased Tension

Adjust the upper looper thread tension lever to 7 to increase the tension on the looper thread.

Serge the third piece of folded fabric, cutting off the fold.

Examine the sample. The looper threads do not lock on the edge of the fabric. The lower looper thread is pulled tightly to the front of the stitch.

Label, trim, and mount the sample.

Upper Looper - Decreased Tension

Change the upper looper thread tension lever to 2 to decrease the tension on the looper thread.

Serge the fourth piece of folded fabric, cutting off the fold.

Examine the sample. The looper threads do not lock on the edge of the fabric. The upper looper thread is visible on the back of the fabric. The looper threads are very loose.

Label, trim, and mount the sample.

Return the thread tension levers to normal.

Notes

Adjusting Tensions Samples

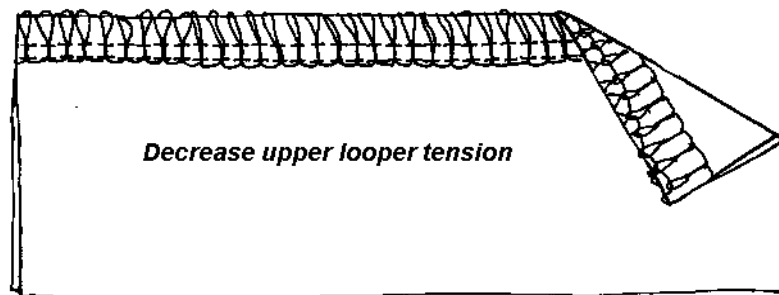
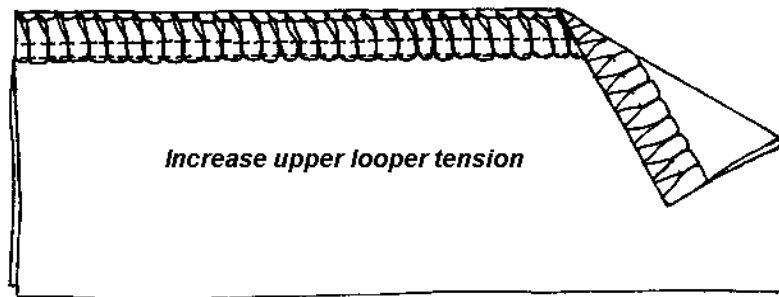

Balanced 4-Thread Overlock

Upper Looper	3-5	Cutting Width	2-3
Lower Looper	3-5	Stitch Length	2.5mm
Left Needle	3-5	Differential Feed	N
Right Needle	3-5	Rolled Edge Lever	in

Adjusting Tensions, continued

Right Needle - Decreased Tension

Adjust the right needle thread tension lever to 2 (down) to decrease the tension on the needle thread.

Serge the fifth piece of folded fabric, cutting off the fold.

Examine the sample. The needle thread forms large loops on the back of the fabric.

Label, trim, and mount the sample.

Left Needle - Decreased Tension

Adjust the left needle thread tension lever to 2 to decrease the tension on the needle thread.

Serge the sixth piece of folded fabric, cutting off the fold.

Examine the sample. The needle thread forms large loops on the back of the fabric.

Label, trim, and mount the sample.

Both Needles - Increased Tension

Adjust both the left and right needle thread tension levers to 7 to increase the tension on the needle threads.

Fold the piece of lightweight woven cotton fabric to 1½" x 4".

Serge the folded fabric, cutting off the fold.

Examine the sample. The lower looper thread is pulled to the front of the sample and the stitch is puckering the fabric.

Label, trim, and mount the sample.

Return both needle thread tension levers to normal.

Notes

Adjusting Tensions Samples

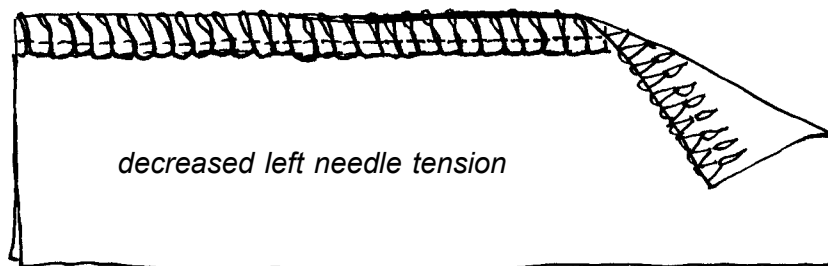
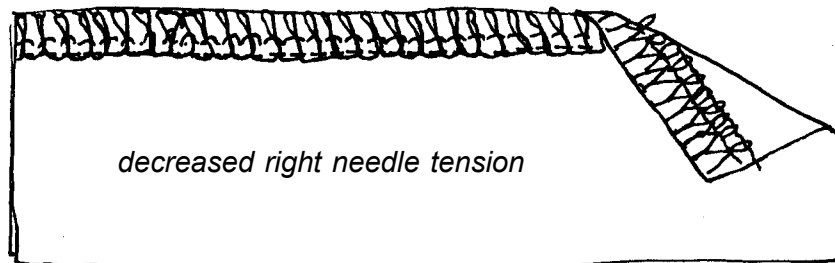
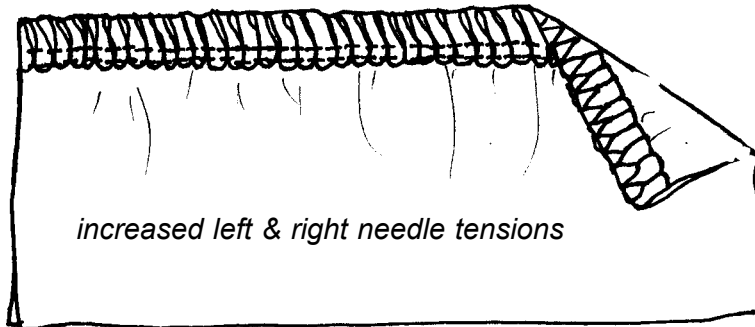

Balanced 4-Thread Overlock

Upper Loper 3-5
Lower Loper 3-5
Left Needle 3-5
Right Needle 3-5

Cutting Width 2-3
Stitch Length 2.5mm
Differential Feed N
Rolled Edge Lever in

Stitch Length Adjustment

Fabric firm fabric, 6" x 6"
Needle 80/12 Universal
Thread 4 cones of serger thread
..... (yellow, red, green, blue)
Presser Foot standard
Stitch 4-thread overlock

Fold fabric in half to 3" x 6".

Using a fabric marker, divide the fabric into four equal sections along the folded edge.

Thread the serger for a four thread overlock stitch. Fine tune the settings as needed. Set the cutting width and the differential at their normal settings.

Adjust the stitch length to 4mm. Serge to the first mark along the folded edge, trimming the fold slightly.

Adjust the stitch length to 3mm and serge to the second mark.

Adjust the stitch length to 2mm and serge to the third mark.

Adjust the stitch length to 1mm and serge to the end.

Mark the stitch length settings on the fabric sample.

Trim and mount the sample.

Return stitch length to its normal setting, 2.5mm.

Notes

Stitch Length Adjustment Sample

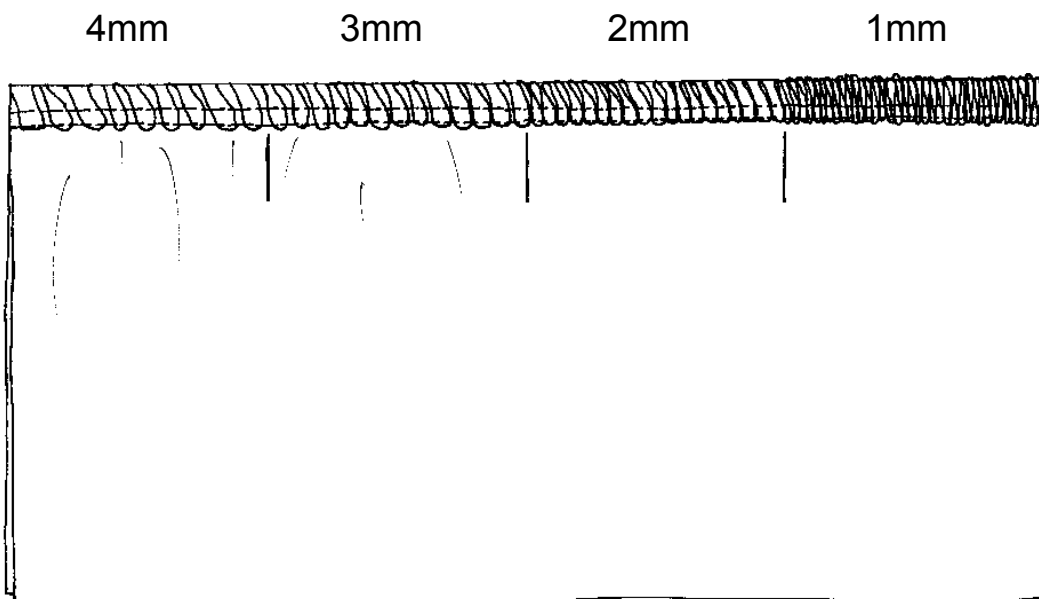

Balanced 4-Thread Overlock

Upper Loper	3-5	Cutting Width	2-3
Lower Loper	3-5	Stitch Length	2.5mm
Left Needle	3-5	Differential Feed	N
Right Needle	3-5	Rolled Edge Lever	in

Cutting Width Adjustment

Fabric firm fabric, 6" x 6"
Needle 80/12 Universal
Thread 4 cones of serger thread
..... (yellow, red, green, blue)
Presser Foot standard
Stitch 4-thread overlock

Fold the fabric in half to 3" x 6".

Divide and mark the fabric into three equal sections along the folded edge.

Thread the serger for a 4-thread overlock stitch. Fine tune the tensions for a balanced overlock stitch (3-5).

Rotate the upper knife up. Adjust cutting width to 3. Rotate the upper knife down into cutting position.

Serge to the first mark on the fabric, stopping when the knife edge is on the mark.

Adjust cutting width to 2mm and serge to the second mark.

Adjust the cutting width to 1mm and serge to the end of the fabric.

Mark the cutting width settings on the sample.

Rotate the upper knife up. Return the cutting width to its normal setting, 2mm. Rotate the upper knife down into cutting position.

Compare the cutting width sample to the balanced 4-thread sample to see how cutting width affects the balance of the overlock stitch.

Notes

Cutting Width Adjustment Sample

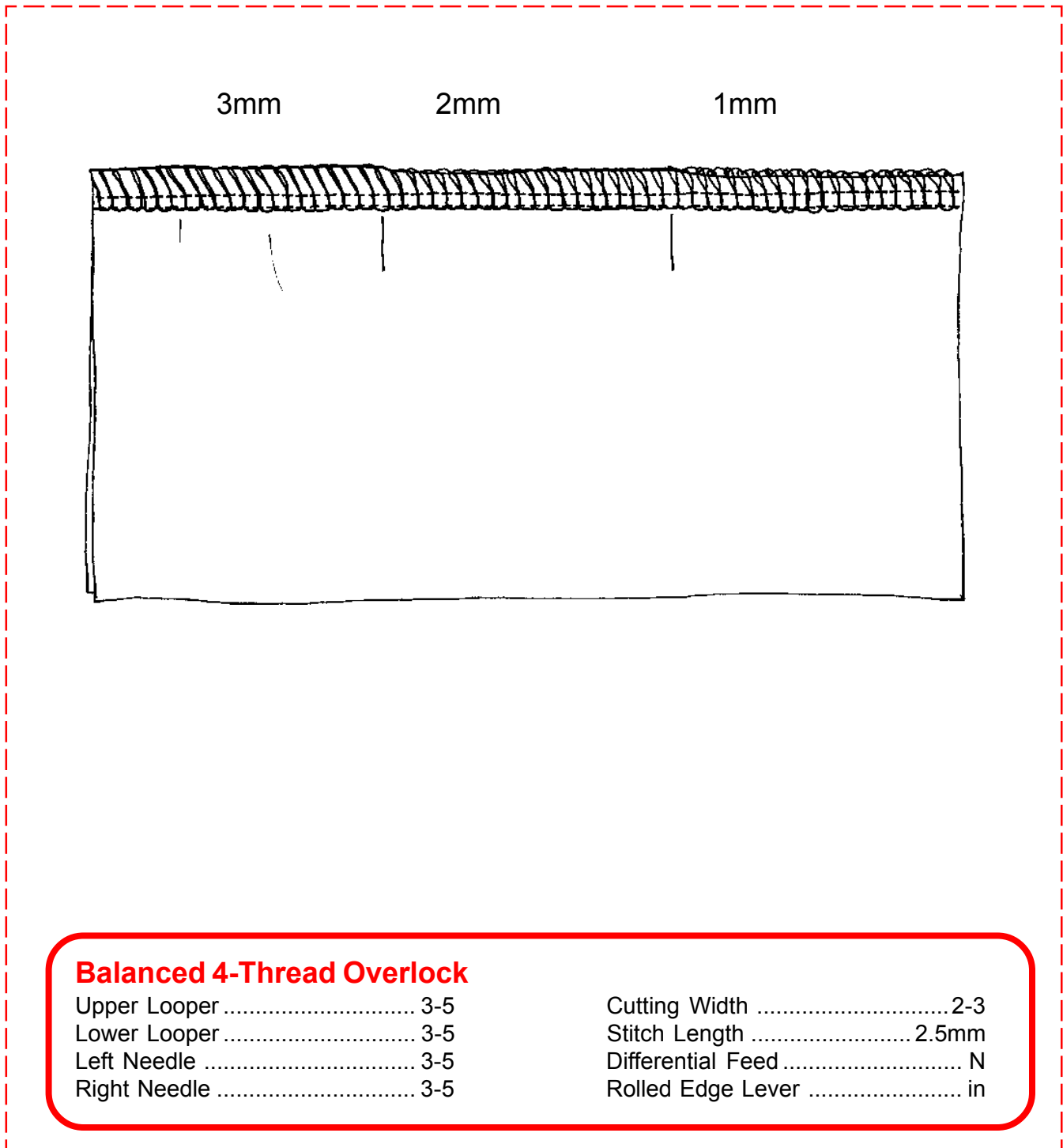

Balanced 4-Thread Overlock

Upper Loper	3-5	Cutting Width	2-3
Lower Loper	3-5	Stitch Length	2.5mm
Left Needle	3-5	Differential Feed	N
Right Needle	3-5	Rolled Edge Lever	in

Differential Feed: Fabrics that Stretch

Fabric 3 pieces of ribbing, each 5" wide x 2" long
Needle 80/12 Universal
Thread 4 cones of serger thread
..... (yellow, red, green, blue)
Presser Foot standard
Stitch 4-thread overlock

Thread the serger for a 4-thread overlock stitch. Fine tune the tensions for a balanced overlock stitch. Set the cutting width as needed and set the stitch length to 2.5mm.

With differential set at N, serge two of the ribbing pieces together along one 5" edge. If the fabric is stretchy enough you will have a wavy edge.

Adjust the differential to 2.0.

Stitching along the 5" side, serge the remaining ribbing to the other side of the piece, trimming slightly. With differential at a higher setting, the wavy edge should be eliminated.

Mark the differential settings on the fabric sample.

Compare the seams to see how the differential settings can affect stretching.

Trim and mount the sample.

Return the differential feed setting to N (normal).

Notes

Differential Feed: Fabrics that Stretch Sample

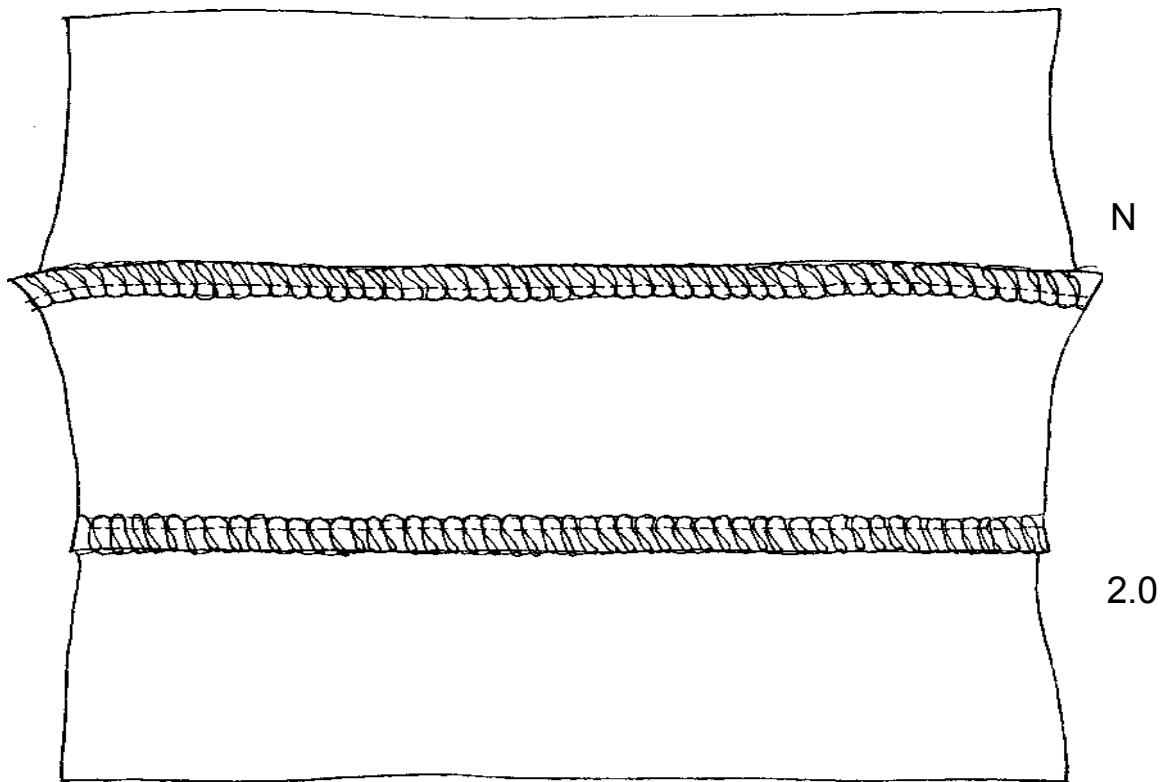

Balanced 4-Thread Overlock

Upper Loper	3-5	Cutting Width	2-3
Lower Loper	3-5	Stitch Length	2.5mm
Left Needle	3-5	Differential Feed	N
Right Needle	3-5	Rolled Edge Lever	in

Differential Feed: Fabrics that Pucker

Fabric 1 piece batiste, 3" x 6"
Needle 80/12 Universal
Thread 4 cones of serger thread
..... (yellow, red, green, blue)
Presser Foot standard
Stitch 4-thread overlock

Thread the serger for a four thread overlock stitch. Fine tune tensions for a balanced overlock stitch. Adjust the stitch length to 2.5mm.

With differential set at N, serge on one 6" edge. If fabric is lightweight enough you will have a puckered edge.

Adjust the differential to 0.7.

Serge along the other edge, trimming slightly. With a low differential setting, the puckered edge should be eliminated.

Mark the differential settings on the fabric sample.

Trim and mount the sample.

Return the differential feed setting to N (normal).

Notes

Differential Feed: Fabrics that Pucker Sample

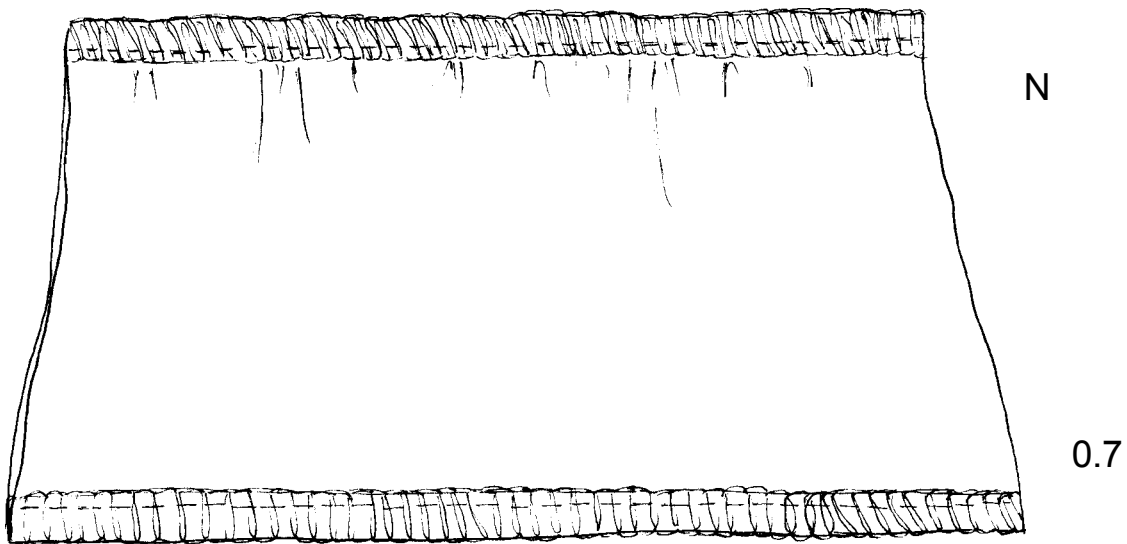

Balanced 4-Thread Overlock

Upper Loper	3-5	Cutting Width	2-3
Lower Loper	3-5	Stitch Length	2.5mm
Left Needle	3-5	Differential Feed	N
Right Needle	3-5	Rolled Edge Lever	in

Differential Feed: Gathering & Easing

Fabric medium weight cotton, 3" x 12"
Needle 80/12 Universal
Thread 4 cones of serger thread
..... (yellow, red, green, blue)
Presser Foot standard
Stitch 4-thread overlock

Using a fabric marker divide the fabric into 3 equal sections along the 12" side.

Thread the serger for a 4-thread overlock stitch. Fine tune the tensions for a balanced overlock stitch.

Turn the differential feed dial to 2. Serge to the first mark.

Adjust stitch length to 4mm and serge to the second mark.

Move the thread tension levers up to 8 to increase the needle thread tensions. Serge to the end of the fabric.

Return the differential feed to "N" (normal).

Return the stitch length to 2.5 (normal).

Move the thread tension levers to return tensions to normal (3-5).

Mark the sample:

Differential Feed 2

Differential Feed 2 & Stitch Length 4

Differential Feed 2 & stitch length 4 & increased needle tension.

Trim and mount the sample.

Notes

Differential Feed: Gathering & Easing Sample

Diff. Feed 2

SL 4mm
Diff. Feed 2

Increased needle tensions
SL 4mm
Diff. Feed 2

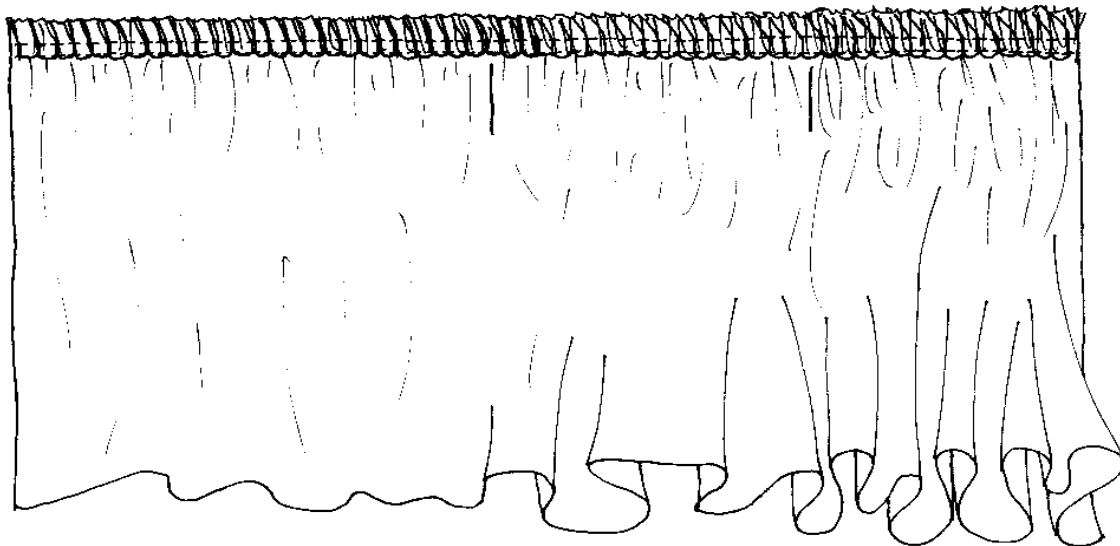

Balanced 4-Thread Overlock

Upper Loper 3-5
Lower Loper 3-5
Left Needle 3-5
Right Needle 3-5

Cutting Width 2-3
Stitch Length 2.5mm
Differential Feed N
Rolled Edge Lever in

Securing Serged Seams

Fabric medium weight cotton, 4" x 6"
Needle 80/12 Universal
Thread 4 cones of serger thread
..... (yellow, red, green, blue)
Presser Foot standard
Stitch 4-thread overlock

Thread the serger for a 4-thread overlock stitch. Fine tune the tensions for a balanced overlock stitch.

Fold fabric in half to 2" x "6" and place under the presser foot. *Note: If you are using a Wavy Rotary Cutter or Pinking Shears to trim the samples, do all trimming before beginning to sew this sample.*

Take 2-3 stitches on the fabric. Lower the needles into the fabric. Raise the presser foot and with your left hand gently pull the thread chain around the needles to the knife.

Lower the presser foot and continue serging (cutting off the excess thread chain) until you are one stitch off the end of the fabric.

Locate the rolled hem lever on the right side of the cloth plate; pull it towards you, releasing the thread chain from the stitch finger.

Raise the presser foot and carefully flip the fabric over so that the lower looper side of the previously serged seam will be overstitched.

Place the fabric under the presser foot so that the first stitch will enter the fabric when you begin stitching.

Slide the rolled hem lever towards the body of the serger.

Serge for about 1", overstitching the previous stitching. Guide the fabric so as not to cut the previous stitching. *Option: Rotate upper knife up.*

Raise the toe of the presser foot and rotate the fabric 90° clockwise.

Serge off the edge of the fabric.

If the upper knife is up, rotate it down into the cutting position.

Trim and mount the sample

Notes

Securing Serged Seams Sample

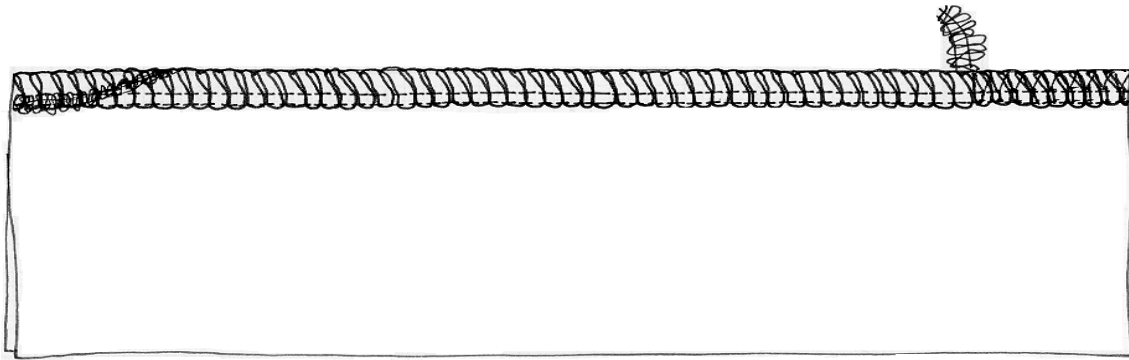

Balanced 4-Thread Overlock

Upper Loper 3-5
Lower Loper 3-5
Left Needle 3-5
Right Needle 3-5

Cutting Width 2-3
Stitch Length 2.5mm
Differential Feed N
Rolled Edge Lever in

Serging a Tube

Fabric medium weight cotton, 3" x 12"
Needle 80/12 Universal
Thread 4 cones of serger thread
..... (yellow, red, green, blue)
Presser Foot standard
Stitch 4-thread overlock

Thread the serger for a 4-thread overlock stitch.

With right sides together, seam the fabric into a tube along the 3" side.

Press the seam to one side. (The upper looper thread is the right side of the seam.)

On one 12" side of the tube, cut away a 2" x ¼" section of fabric.

Lower the presser foot and serge around the tube, cutting off ¼". Stop serging when the knife enters the cutout; rotate the knife up.

Continue serging to complete the circle, overlapping the previous stitching by 1".

Raise the presser foot and rotate the fabric clockwise.

Lower the presser foot and serge off the edge of the fabric.

Return the knife to the normal cutting position.

Trim and mount the sample.

Notes

Serging a Tube Sample

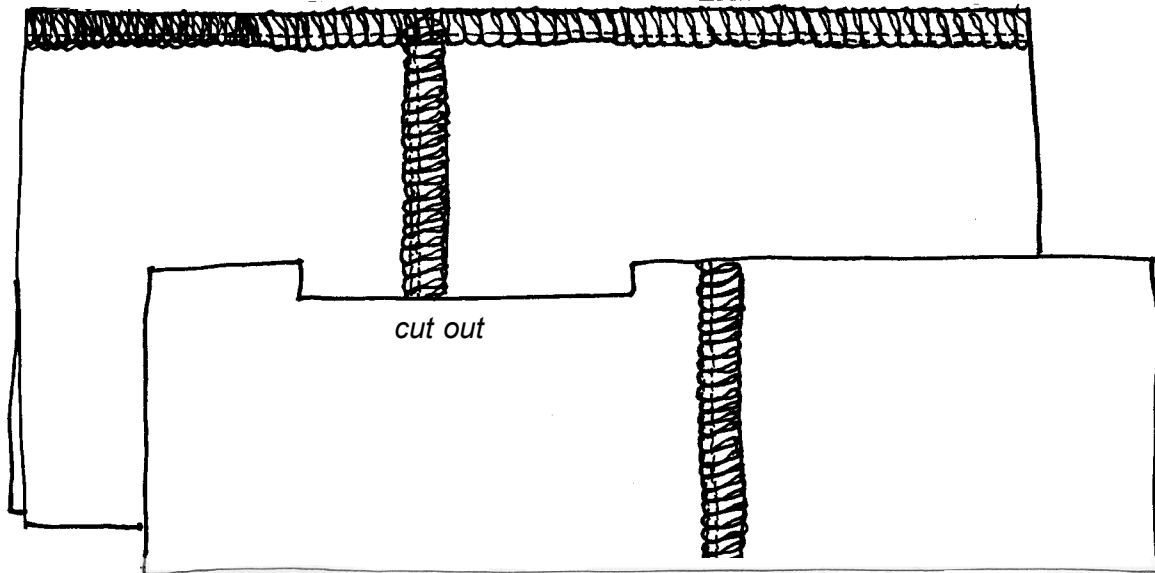

Balanced 4-Thread Overlock

Upper Loper 3-5
Lower Loper 3-5
Left Needle 3-5
Right Needle 3-5

Cutting Width 2-3
Stitch Length 2.5mm
Differential Feed N
Rolled Edge Lever in

Class 1

General Information

Product Reference List

- Feet-ures, Unit M
- Serger Technique Reference Book*
- Serging Made Easy!*
- Carrying Case

- Serger Cone Thread (Mettler Metrocor, YLI Success)
 - color _____
 - color _____
 - color _____
 - color _____

- Needles
 - size _____ and type _____
 - size _____ and type _____
 - size _____ and type _____
 - size _____ and type _____

- Seam Sealant
- Fabric Marking Pen
- Rotary Cutter
- Wavy Cutting Blade
- Clear Quilters' Ruler
- Cutting Mat
- Fabric Glue Stick
- Large Eye Tapestry/Darning Needles
- Vacuum Cleaner Attachment
- 1" Wide Cosmetic Brush or Mini-Duster
- BERNINA® Thread Storage Box (clear)
- BERNINA® Deluxe Accessory Box

- Standard Serger Foot with Tape Guide
- Scrap catcher
- Serger Needle/Looper Threader

Class 2

Four Thread Techniques

Class Overview

General Construction Seaming

- 1 4-Thread Overlock Seam

Serging Knits

- 2 Seaming Knit Fabrics: Presser Foot Pressure
- 3 Seaming Knit Fabrics: Differential Feed
- 4 Seaming Knit Fabrics: Presser Foot Tape Guide
- 5 Attaching Ribbing

Serging Wovens

- 6 Serger Piecing
- 7 Reversible Piecing

Using Optional Accessories: Elasticator & Gathering Attachment

- 8 Elasticator
- 9 Gathering Attachment: Gathering Fabric
- 10 Gathering Attachment: Gathering Fabric to Fabric
- 11 Gathering Attachment: with Elasticator

Optional Presser Feet & Accessories (used in this unit)*Standard Presser Foot with Tape Guide*

Holds narrow twill tape, elastic, and ribbon to be serged into seam

Elasticator

For attaching elastic from 5mm -12mm (¼" to ½") wide.

Attachment Base (700D and 800DL only)

Needed to attach some accessories to serger

Seam Guides

Right Seam Guide

Multi-Purpose Foot Guide

Gathering Attachment

For gathering one layer, or gathering to a flat piece

This class is formatted for owners of the following models of BERNINA® overlock machines:

- 700 D
- 800 DL
- 1100D
- 1100DA
- 1200DA
- 1300DC
- 2500DCET

4-Thread Overlock Seam

Fabric medium weight cotton, 5" x 6"
Needle 80/12 Universal
Thread 4 cones of serger thread
..... (yellow, red, green, blue)
Presser Foot standard
Stitch 4-thread overlock

Thread the serger for a 4-thread overlock stitch. Adjust settings as indicated. Fine tune as needed.

Locate the seam guide markings on the knife guard. Measurements shown are distances from the right needle. When using the left needle, add 1/8" to measurements. *Tip: Use a permanent marker to highlight the raised markings; this is particularly useful for those with "mature" eyesight.*

Fold fabric in half to 2½" x 6".

Align the fold of the fabric with the ½" mark on the knife guard (the left needle is being used). Serge the seam, cutting off exactly 3/8".

Trim and mount the sample.

Notes

4-Thread Overlock Seam Sample

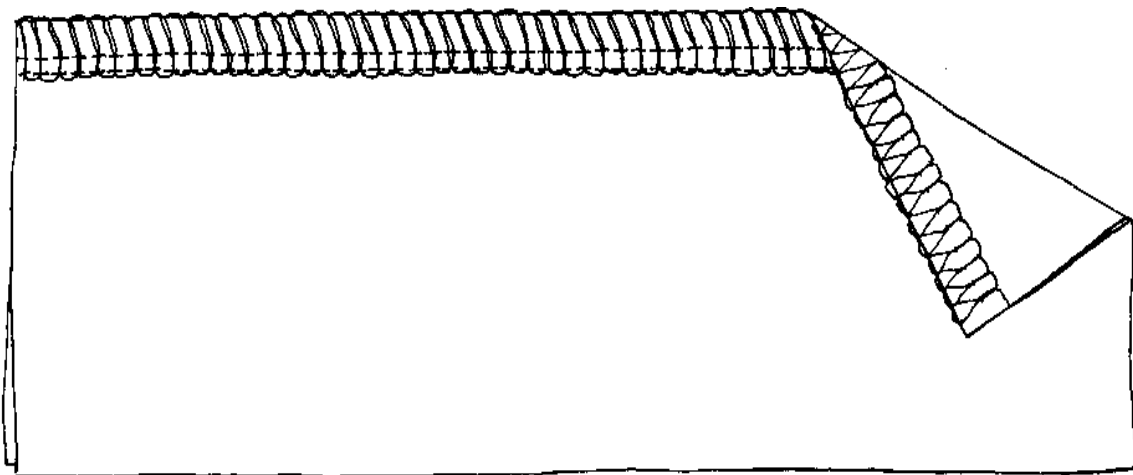

Balanced 4-Thread Overlock

Upper Loper	3-5	Cutting Width	2-3
Lower Loper	3-5	Stitch Length	2.5mm
Left Needle	3-5	Differential Feed	N
Right Needle	3-5	Rolled Edge Lever	in

Seaming Knit Fabrics: Presser Foot Pressure

Fabric 2 pieces cotton single knit jersey,
..... each 3" x 6" with stretch across 3" side
Needle 75/11 Stretch or Ballpoint
Thread 2 cones of serger thread (needles)
..... 2 cones YLI Woolly Nylon (loopers)
Presser Foot standard
Stitch 4-thread overlock

Thread the serger for a 4-thread overlock stitch, using regular serger thread in the needles and Woolly Nylon in the loopers.

Set all thread tensions at usual 4-thread overlock settings.

Using a fabric marker, divide the fabric in half along a 6" side.

With right sides together and a 1/4" seam allowance, serge to the mark on the fabric.

Without removing the fabric from under the presser foot, notice the "ripple" effect where the fabric has stretched.

Reduce the presser foot pressure to low.

Seam the jersey to the end of the fabric.

Remove the fabric from under the presser foot and observe the decreased "rippling".

Return the presser foot pressure adjusting lever its normal setting.

Trim and mount the sample.

Record settings in chart below:

Notes

Seaming Knits: Presser Foot Pressure Sample

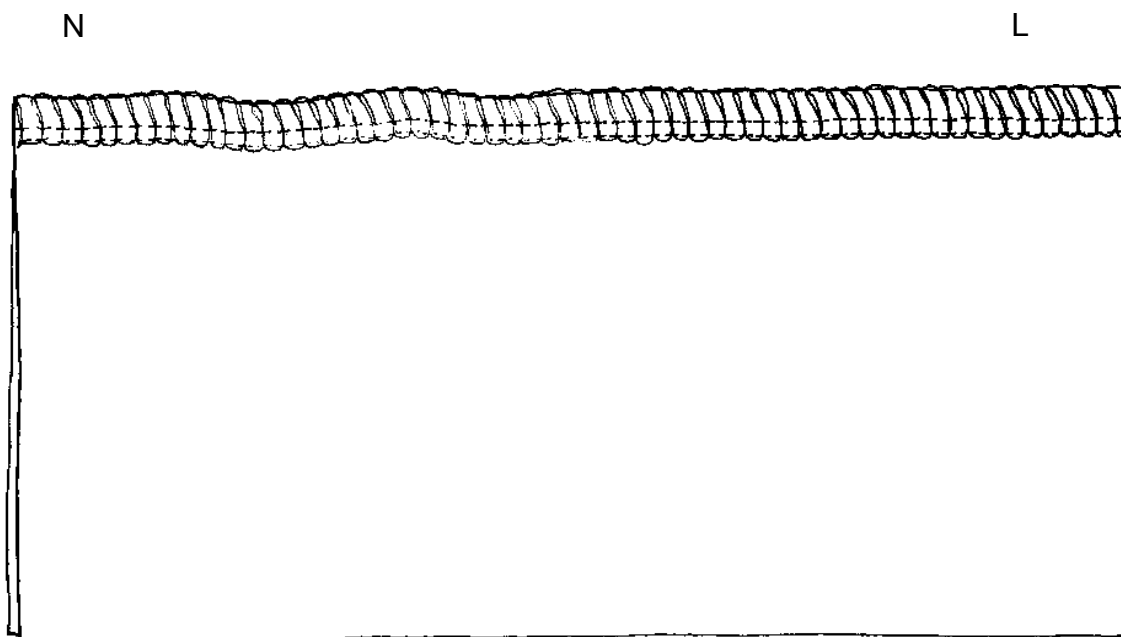

Balanced 4-Thread Overlock

Upper Looper	3-5	Cutting Width	2-3
Lower Looper	3-5	Stitch Length	2.5mm
Left Needle	3-5	Differential Feed	N
Right Needle	3-5	Rolled Edge Lever	in

Seaming Knit Fabrics: Differential Feed

Fabric 2 pieces cotton single knit jersey,
..... each 3" x 6" with stretch across 3" side
Needle 75/11 Stretch or Ballpoint
Thread 2 cones of serger thread
..... 2 cones YLI Woolly Nylon
Presser Foot standard
Stitch 4-thread overlock

Thread the serger for a 4-thread overlock stitch, using regular serger thread in the needles and Woolly Nylon in the loopers.

Set all thread tensions at usual 4-thread overlock settings.

Using a fabric marker, divide the fabric in half along a 6" side.

With right sides together and a ¼" seam allowance, serge to the mark on the fabric.

Without removing the fabric from under the presser foot, notice the "ripple" effect where the fabric has stretched.

Locate the differential feed dial on the serger. Adjust to 1.5.

Seam the jersey to the end of the fabric.

Remove the fabric from under the presser foot and observe the decreased "rippling".

Return the differential feed dial to normal setting (N).

Trim and mount the sample.

Notes

Seaming Knit Fabrics: Differential Feed Sample

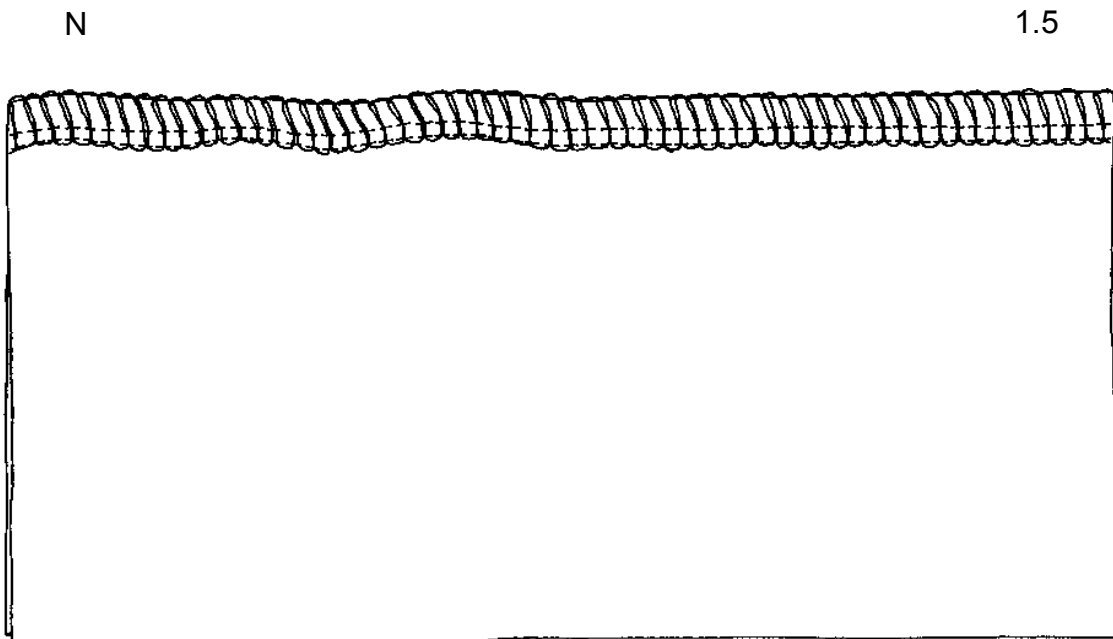

Balanced 4-Thread Overlock

Upper Looper	3-5	Cutting Width	2-3
Lower Looper	3-5	Stitch Length	2.5mm
Left Needle	3-5	Differential Feed	N
Right Needle	3-5	Rolled Edge Lever	in

Seaming Knit Fabrics: Presser Foot Tape Guide

Fabric	2 pieces cotton single knit jersey, each 3" x 6" with stretch across 3" side 8" length of ¼" twill tape or ribbon
Needle	75/11 Stretch or Ballpoint
Thread	2 cones of serger thread 2 cones YLI Woolly Nylon
Presser Foot	Standard Foot with Tape Guide
Stitch	4-thread overlock

Thread the serger for a 4-thread overlock stitch. Adjust tension settings for a balanced 4-thread overlock.

Locate the tape guide on the presser foot.

Using the small screwdriver from the accessory pouch, loosen the fixing screw and slide the tape guide all the way to the left. Snug the screw.

Slip the twill tape or ribbon into the slot on the presser foot.

Lower the presser foot and lower the needles into the tape or ribbon.

Loosen the fixing screw and adjust the tape guide to the width of the tape or ribbon. Retighten the screw.

Seam the jersey together along the 6" side, catching the tape or ribbon in the serged edge.

Remove the fabric from under the presser foot and examine the seam. It will not stretch. The tape or ribbon has stabilized the seam.

Trim and mount the sample.

Notes

Seaming Knits: Presser Foot Tape Guide Sample

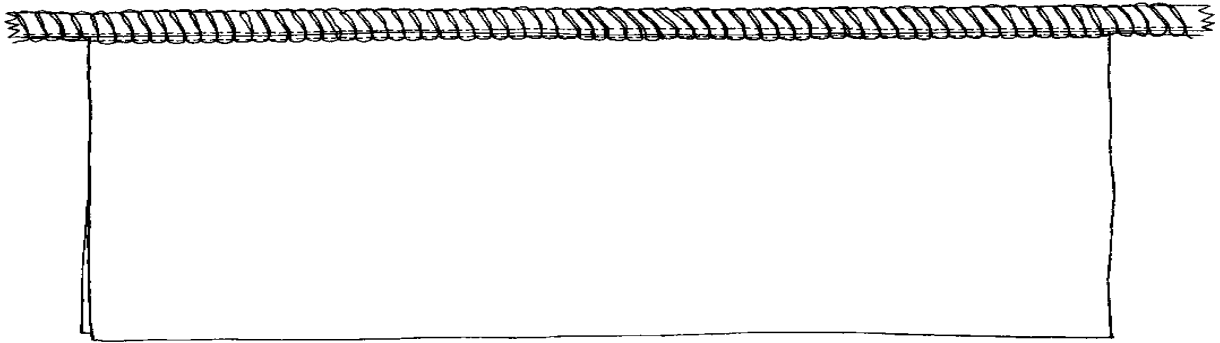

Balanced 4-Thread Overlock

Upper Looper	3-5	Cutting Width	2-3
Lower Looper	3-5	Stitch Length	2.5mm
Left Needle	3-5	Differential Feed	N
Right Needle	3-5	Rolled Edge Lever	in

Attaching Ribbing

Fabric sweatshirt fleece, 4" x 6"
..... ribbing, 6" wide x 2½" long
Needle 75/11 Stretch or Ballpoint
Thread 2 cones of serger thread
..... 2 cones YLI Woolly Nylon
Presser Foot Standard Foot with Tape Guide
Stitch 4-thread overlock

Thread the serger for a 4-thread overlock stitch using Woolly Nylon in both loopers. Set tensions for a balanced 4-thread overlock.

Cut a mock neckline on the corner of the fleece (quarter circle).

Fold the ribbing in half (wrong sides together) to 1¾" x 6".

Matching raw edges, place the ribbing to the neckline on the right side of the fleece.

Serge the ribbing to the fleece, stretching the ribbing to meet the fleece neckline.

Trim and mount the sample.

Notes

Attaching Ribbing Sample

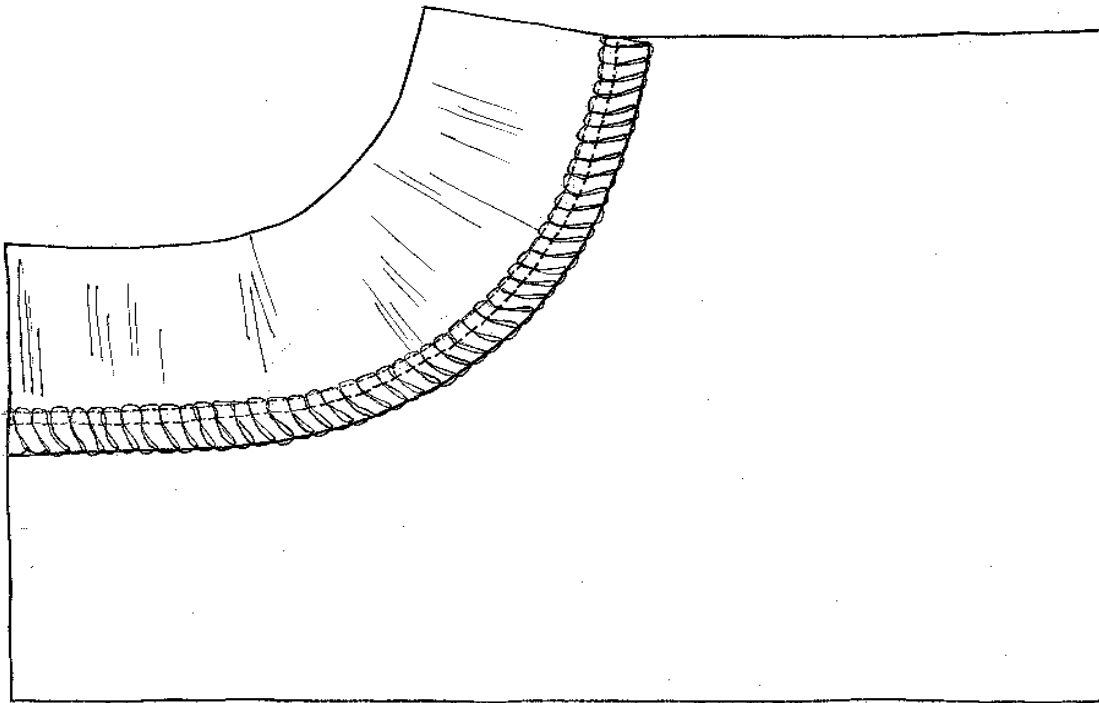

Balanced 4-Thread Overlock

Upper Loper	3-5	Cutting Width	2-3
Lower Loper	3-5	Stitch Length	2.5mm
Left Needle	3-5	Differential Feed	N
Right Needle	3-5	Rolled Edge Lever	in

Serger Piecing

Fabric 3 strips medium weight cotton 1 3/4" x 4" each
..... 3 strips contrasting cotton, 1 3/4" x 4" each
Needle 80/12 Universal, Sharp, or Microtex
Thread 4 cones serger thread
..... 2 cones YLI Woolly Nylon
Presser Foot standard
Stitch 4-thread overlock

Thread the serger for a 4-thread overlock stitch, with regular serger thread in the needles and the loopers. Set all tensions for a balanced 4-thread overlock.

Create two strip sets, each with three alternating strips of fabric. Strip #1 is light-dark-light; strip #2 is dark-light-dark. Serge strips together without trimming any fabric. Press seam allowances toward dark strips.

Using a rotary cutter, mat and ruler, cut the strip sets into 1 3/4" block sets.

Use 1 block set from the light/dark/light strip set and 2 block sets from the dark/light/dark strip set. Discard the excess fabric.

Serge 1 dark/light/dark strip to the light/dark/light strip, matching seam allowances. The opposing seams will "nest" into each other.

Serge the remaining dark/light/dark strip to the light/dark/light strip.

Press the seam allowances to the dark/light/dark strips.

Trim thread tails and mount the sample on the following page.

Notes

Serger Piecing Sample

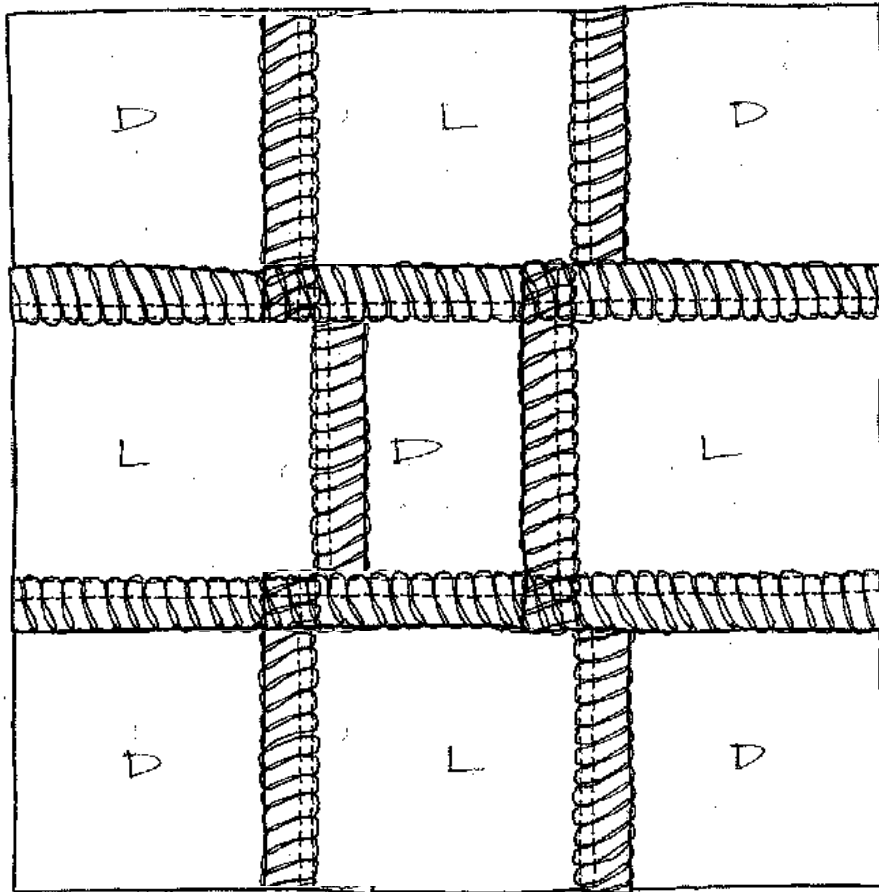

Balanced 4-Thread Overlock

Upper Loper	3-5	Cutting Width	2-3
Lower Loper	3-5	Stitch Length	2.5mm
Left Needle	3-5	Differential Feed	N
Right Needle	3-5	Rolled Edge Lever	in

Reversible Piecing

Fabric	3 pieces cotton prints, 2" x 4"
.....	1 piece cotton print, 2" x 5½"
.....	3 pieces muslin, 2" x 4"
.....	1 piece muslin, 2" x 5½"
.....	3 pieces batting, 2" x 4"
.....	1 piece batting, 2" x 5½"
Needle	80/12 Universal, Sharp, or Microtex
Thread	4 cones serger thread
Presser Foot	standard
Stitch	4-thread overlock

Notes

Thread the serger for a 4-thread overlock stitch. Set all tensions for a balanced 4-thread overlock.

Optional: Increase the presser foot pressure for thick fabrics.

Create a quilt sandwich, layering the 4" fabrics as follows: 2 layers of muslin (right sides together), one layer of batting, 2 layers of printed fabric (right sides together) and a layer of batting on top.

Raise the presser foot and position the fabrics under it with the right edges of the fabric and batting even with the left edge of the knife.

Serge the 6 layers together, stopping as necessary to keep the right edges of the fabrics even. Open the layers (1 muslin, 1 quilt top, 1 batting) to the right and left of the serged seam and press.

To serge the third section into place, layer the remaining 4" fabrics as follows: muslin to muslin, right sides together; print to print, right sides together; batting on top.

Serge through all 6 layers. Open the last 3 layers; press.

Add the last section to the *top edge* of the 3-paneled quilt. Layer the 5½" fabrics as follows: muslin to muslin, right sides together; print to print, right sides together; batting on top.

Serge, open the layers to the top of the square, and press.

Trim and mount the sample on the following page.

Reversible Piecing Sample

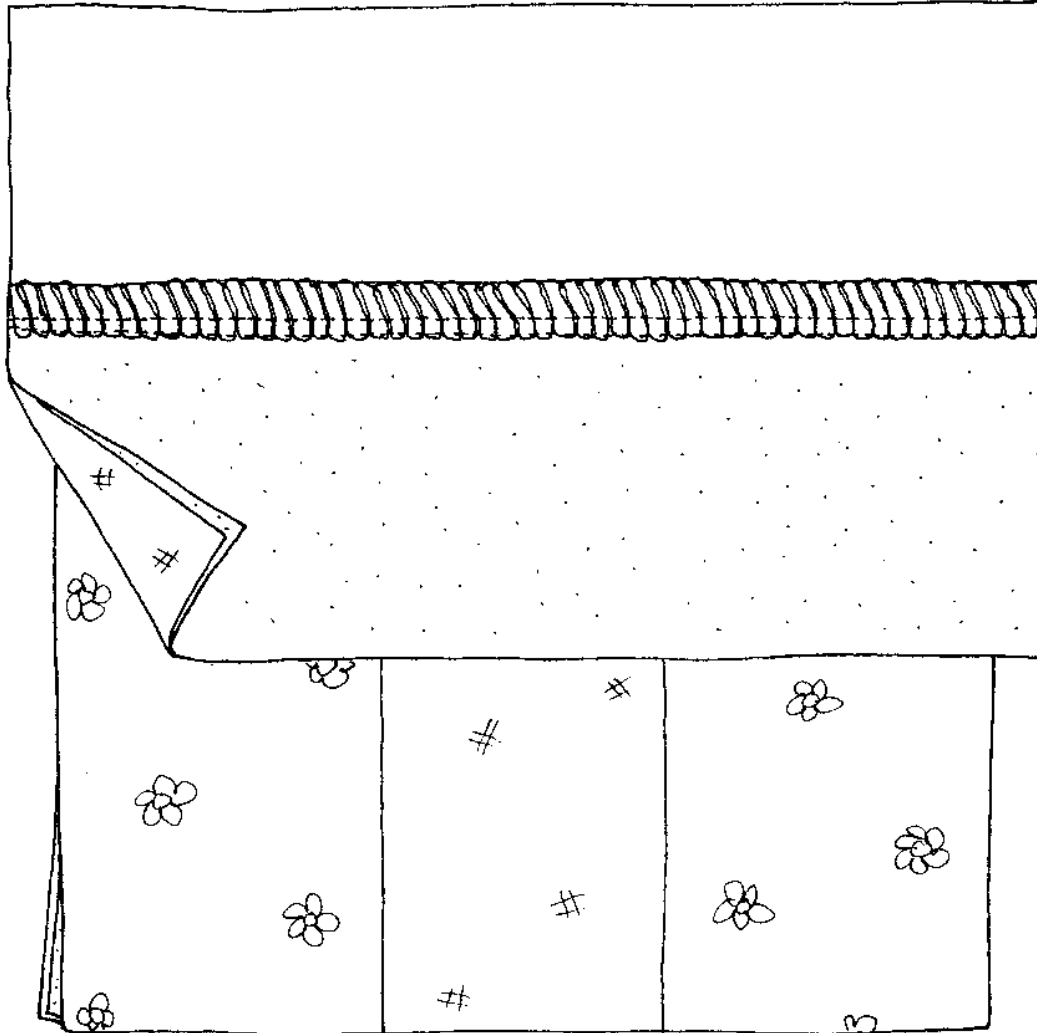

Balanced 4-Thread Overlock

Upper Loper	3-5	Cutting Width	2-3
Lower Loper	3-5	Stitch Length	2.5mm
Left Needle	3-5	Differential Feed	N
Right Needle	3-5	Rolled Edge Lever	in

Elasticator

Fabric	mediumweight cotton, 3" x 12"
.....	12" length of ½" nylon or cotton braid elastic
Needle	75/11 Stretch or Ballpoint
Thread	2 cones serger thread
.....	2 cones YLI Woolly Nylon
Presser Foot	Elasticator
Stitch	4-thread overlock

Thread the serger for a 4-thread overlock stitch. Set tensions for a balanced stitch. Attach the Elasticator to the serger.

Adjust stitch length to 4mm.

Increase the presser foot pressure.

Locate and raise the roller guide in the front of the presser foot. Turn the handwheel to lower the needles. (This also lowers the feed dog.) Raise the presser foot and insert the elastic through the slot and under the presser foot until it touches the needles.

Lower the presser foot and serge a few stitches to catch and straighten the elastic along the right edge of the slot. Turn the handwheel to lower the needles.

Lower the roller guide. Using the small screwdriver, adjust the guide plate on the presser foot to the width of the elastic.

Locate the pressure adjustment set screw (on the top of the roller guide) and turn the screw counterclockwise to completely loosen the pressure on the roller.

Place the fabric under the presser foot and begin serging. Slowly tighten the pressure adjustment set screw to increase the pressure on the roller and stretch the elastic. *Note: Do not over tighten the screw. Excessive pressure on the elastic will bind the fabric.* Serge the elastic onto the fabric letting the presser foot stretch the elastic for you.

Trim and mount the sample.

Return all settings to normal.

Notes

Elasticator Sample

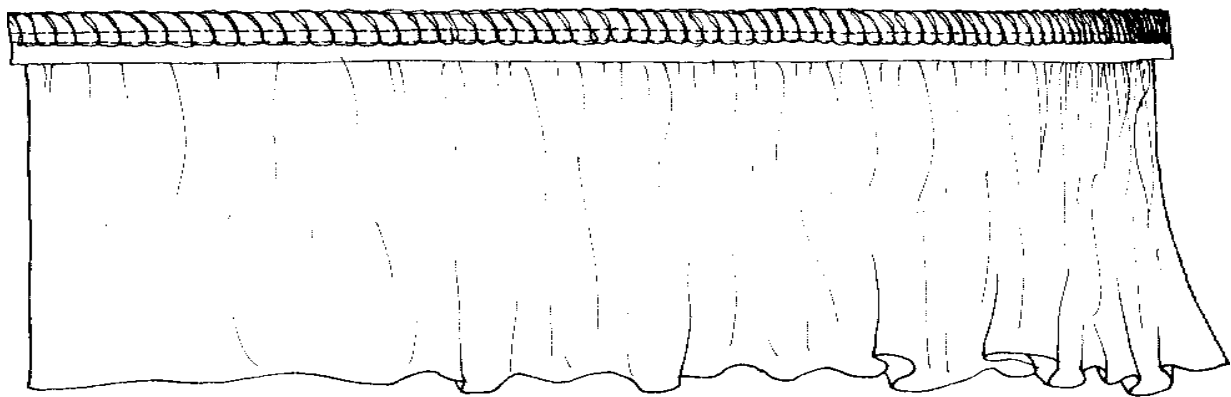

Balanced 4-Thread Overlock

Upper Looper	3-5	Cutting Width	2-3
Lower Looper	3-5	Stitch Length	2.5mm
Left Needle	3-5	Differential Feed	N
Right Needle	3-5	Rolled Edge Lever	in

Gathering Attachment: Gathering Fabric

Fabric mediumweight cotton, 3" x 12"
Needle 80/12 Universal
Thread 4 cones serger thread
Presser Foot standard
Other Gathering Attachment
Stitch 4-thread overlock

If necessary, install the attachment base on your serger (700D and 800DL only).

Raise the cutting knife and adjust cutting width to 3mm. Slip Gathering Attachment on to the fixing screw and metal post directly behind the fixing screw. *Hint: Place the horseshoe-shaped slot over the screw, then rotate the attachment to lock over the metal post.* Tighten fixing screw.

Set cutting width at 2mm (normal) and lower the upper knife into cutting position. Locate and adjust the differential feed dial to 2. Using a fabric marker, divide fabric into 3 sections along one 12" edge.

Turn the handwheel to lower the needles. (This also lowers the feed dog.) Raise the presser foot and insert the fabric under the Gathering Attachment, up against the needles. The fabric is lying against the stitch plate.

Lower the presser foot and serge to the first mark.

Adjust the stitch length to 4mm and serge to the second mark.

Increase the tension on both needles to 7. Serge to the end of the fabric.

Mark the sample: with Differential Feed; with Differential Feed & SL4; with Differential Feed, SL4 and tightened needle tensions.

Mount the sample on the following page.

Return all settings to normal.

The attachment base can remain on the machine.

Notes

Gathers Plus

For even more gathers, tighten needle tensions slightly and increase stitch length to 4mm.

Gathering Attachment: Gathering Fabric Sample

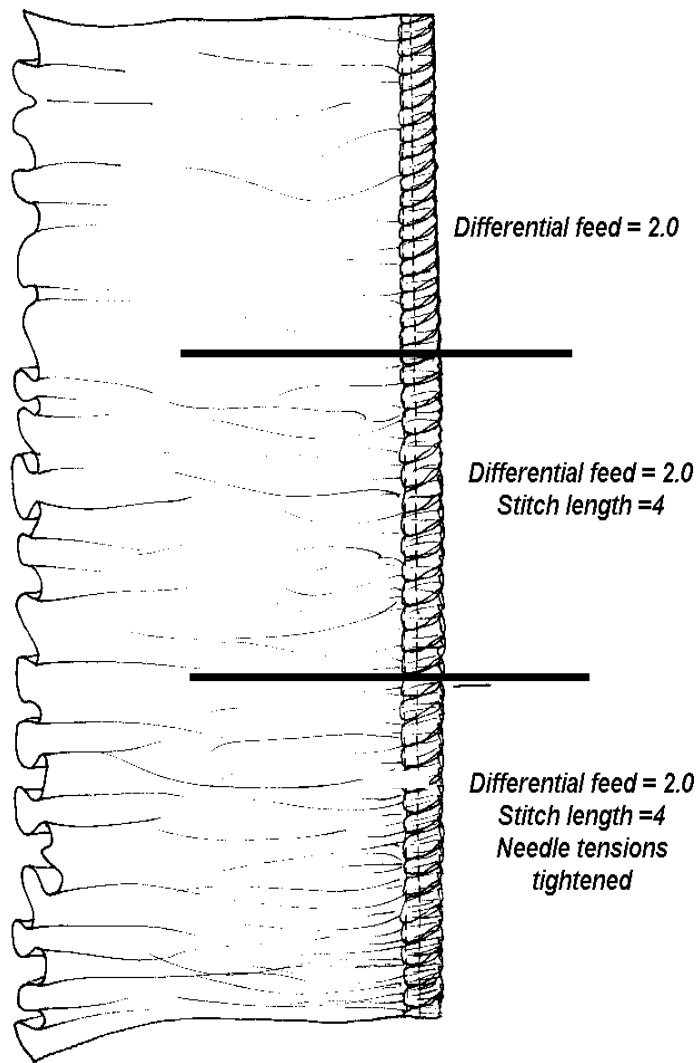

Balanced 4-Thread Overlock

Upper Looper	3-5	Cutting Width	2-3
Lower Looper	3-5	Stitch Length	2.5mm
Left Needle	3-5	Differential Feed	N
Right Needle	3-5	Rolled Edge Lever	in

Gathering Attachment: Gathering Fabric to Fabric

Fabric	mediumweight cotton, 3" x 14"
.....	mediumweight cotton, 3" x 8"
Needle	80/12 Universal
Thread	4 cones serger thread
Presser Foot	standard
Other	Gathering Attachment
Stitch	4-thread overlock

Thread the serger for a 4-thread overlock stitch. Set tensions for a balanced 4-thread overlock.

Raise cutting knife and adjust cutting width to 3mm. Slip the Gathering Attachment on to the fixing screw and metal post directly behind the fixing screw. *Hint: attach the horseshoe-shaped slot over the screw and then rotate the attachment to lock over the metal post.* Tighten the fixing screw.

Return cutting width to 2mm (normal) and lower the upper knife into cutting position.

Adjust the differential feed dial to 2.

Raise the presser foot and insert the 14" strip of fabric (*right side up*) under the Gathering Attachment. The fabric is lying next to the stitch plate. Lower presser foot. Sew several stitches until the fabric is under the needles.

Turn the handwheel to lower the needles. (This also lowers the feed dog.) Place the 8" strip of fabric (*right side down*) on top of the Gathering Attachment and under the presser foot with the end of the 8" strip touching the needles.

Serge the two strips together, the lower strip will gather as you sew.

Trim and mount the sample.

Return all settings to normal.

Notes

Gathers Plus

For even more gathers, tighten needle tensions slightly and increase stitch length to 4mm.

Gathering Attachment: Fabric to Fabric Sample

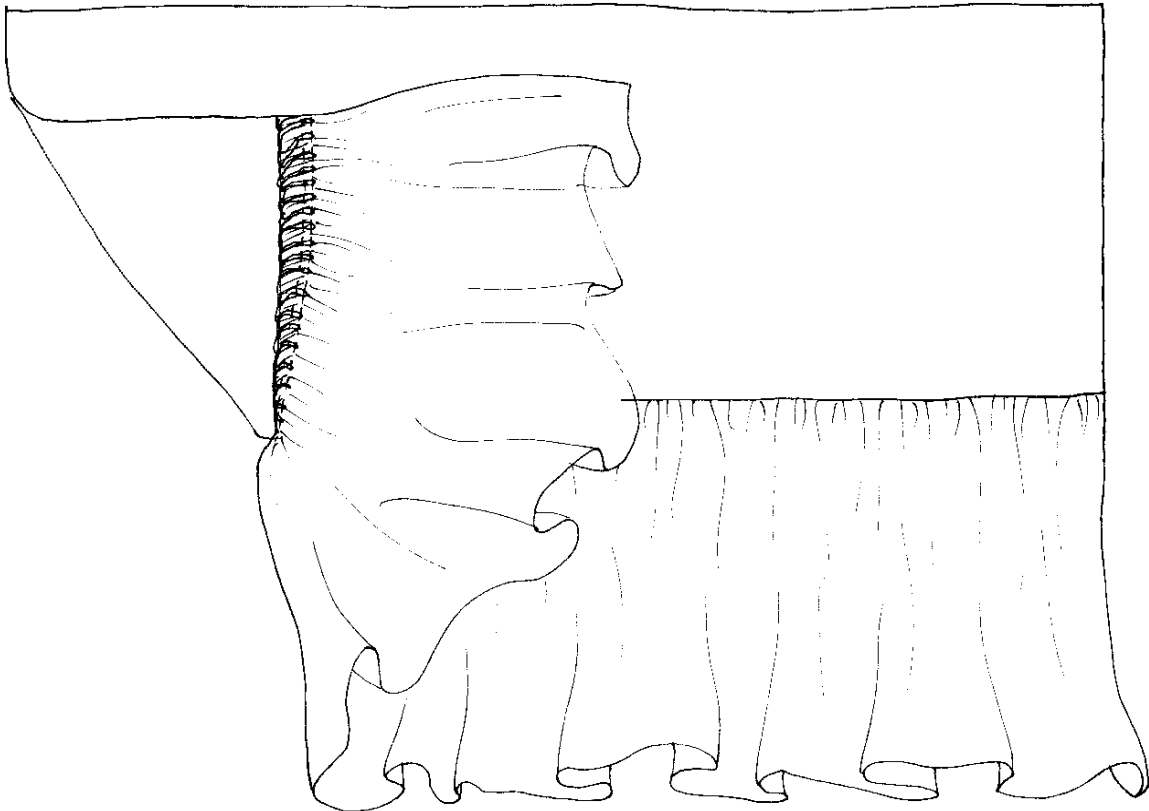

Balanced 4-Thread Overlock

Upper Loper 3-5
Lower Loper 3-5
Left Needle 3-5
Right Needle 3-5

Cutting Width 2-3
Stitch Length 2.5mm
Differential Feed N
Rolled Edge Lever in

Gathering Attachment: With Elasticator

Fabric	mediumweight cotton, 3" x 18"
.....	12" length of ½" nylon or cotton braid elastic
Needle	80/12 Universal
Thread	4 cones serger thread
Presser Foot	Elasticator
Other	Gathering Attachment
Stitch	4-thread overlock

Thread the serger for a 4-thread overlock stitch. Set tensions for a balanced 4-thread overlock.

Attach the Gathering Attachment to the serger.

Adjust the differential feed dial to 2.

Attach the Elasticator Foot. Raise the presser foot and insert the 18" strip of fabric under the Gathering Attachment. Sew several stitches until the fabric is under the needles.

Turn the handwheel to lower the needles. (This also lowers the feed dog.) Decrease the presser foot pressure.

Raise the roller guide and insert the elastic into the slot at the front of the presser foot.

Lower the presser foot and take a few stitches into the elastic.

As you serge, slowly tighten the pressure adjustment set screw to increase the pressure on the roller and stretch the elastic. *Note: Do not over tighten the screw. Excessive pressure on the elastic will bind the fabric.*

Serge the elastic onto the fabric letting the presser foot stretch the elastic.

Trim and mount the sample.

Return all settings to normal.

Notes

Gathering Attachment: With Elasticator Sample

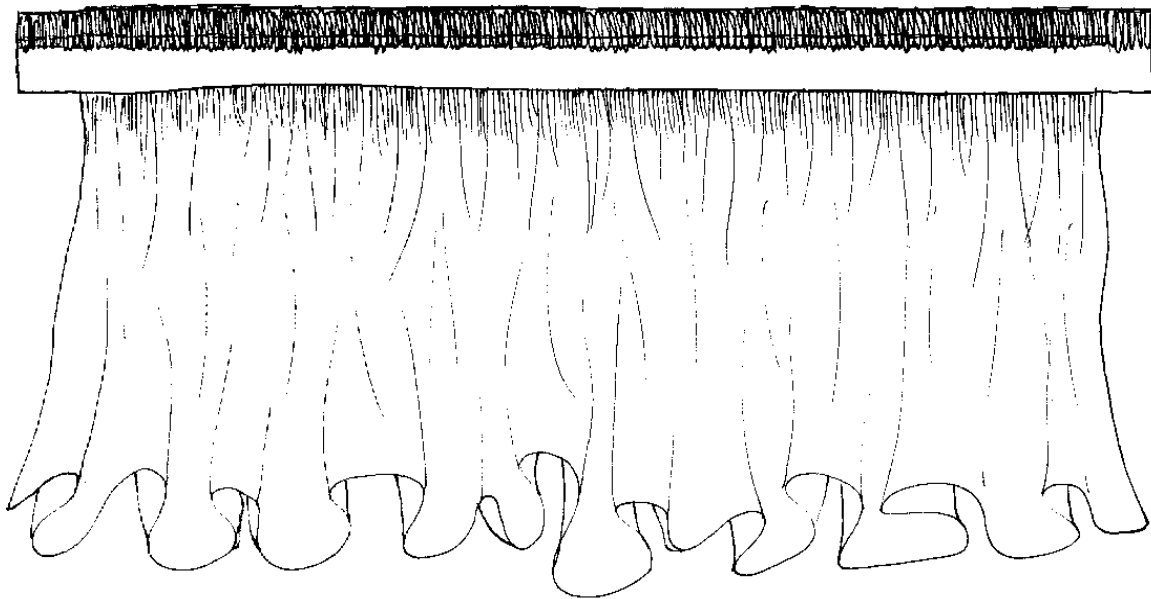

Balanced 4-Thread Overlock

Upper Loper 3-5
Lower Loper 3-5
Left Needle 3-5
Right Needle 3-5

Cutting Width 2-3
Stitch Length 2.5mm
Differential Feed N
Rolled Edge Lever in

Class 2

Four-Thread Overlock Techniques

Product Reference List

- Feet-ures, Unit M
- Serger Technique Reference Book*

- Carrying Case
- Standard Foot with Tape Guide
(700D and 800DL only)
- Elasticator
- Gathering Attachment
- Attachment Base (700D and 800DL only)

- ½" Nylon Elastic
- ½" Cotton Braid Elastic
- ½" Clear Elastic
- ¼" Twill Tape
- ¼" Ribbon

- Wavy Cutting Blade
- Clear Quilters' Ruler
- Cutting Mat
- Fabric Glue Stick
- Large Eye Tapestry/Darning Needles
- Vacuum Cleaner Attachment
- 1" Wide Cosmetic Brush or Mini-Duster
- BERNINA® Thread Storage Box (clear)
- BERNINA® Deluxe Accessory Box
- Scrap catcher
- Serger Needle/Looper Threader
- 6" Ruler/Gauge

- Serger thread (Mettler Metrocor, YLI Elite)
 - color _____
 - color _____
 - color _____
 - color _____

- Woolly Nylon texturized thread
 - color _____
 - color _____
 - color _____
 - variegated _____
 - variegated _____

- Needles
 - Stretch
 - size _____
 - size _____
 - Ballpoint
 - size _____
 - size _____
 - Sharp
 - size _____
 - size _____
 - Microtex
 - size _____
 - size _____
 - Universal
 - size _____
 - size _____

Class 3

Three-Thread Techniques

Class Overview

3-Thread Overlock

- 1 Wide 3-Thread Overlock
- 2 Wide Overlock Seam Finish
- 3 Outside Corners
- 4 Narrow 3-Thread Overlock
- 5 Narrow Overlock Seam Finish
- 6 Inside Corners
- 7 3-Thread Narrow Seam
- 8 Turning Tubes

3-Thread Flatlock

- 9 Narrow 3-Thread Flatlock
- 10 Blindstitch Foot - Blind Hem
- 11 Blindstitch Foot -
Hand-Picked or Drapery Blind Hem
- 12 Blindstitch Foot - Decorative Tucks
- 13 Blindstitch Foot - Joining Lace to Lace

3-Thread Rolled Hem

- 14 3-Thread Rolled Hem
- 15 Cording Foot - Bias Ruffle
- 16 Cording Foot - Wire-Edged Fabric

Optional Presser Feet & Accessories (used in this unit)

Blindstitch Foot

Adjustable guide for aligning stitches

Cording Foot

Guides for small cord, wire, fishline

This class is formatted for owners of the following models of BERNINA® overlock machines:

- 700 D
- 800 DL
- 1100D
- 1100DA
- 1200DA
- 1300DC
- 2500DCET

Wide Three-Thread Overlock Seam

Fabric mediumweight wool, 5" x 6"
Needle 80/12 Universal
Thread 3 cones serger thread
Presser Foot standard
Stitch wide 3-thread overlock

Notes

Using the small screwdriver and brush/needle insertion tool, remove the right needle. *Note: If necessary, insert left needle before removing right needle.*

Snug the needle set screw after removing the needle.

Following the diagrams in your owner's manual, thread the serger for a wide 3-thread overlock stitch.

Set all thread tensions as indicated for a balanced stitch.

Adjust cutting width to 2mm (normal).

Adjust stitch length to 2.5mm (normal).

Fold fabric in half to 2½" x 6".

Serge along the folded edge of the fabric.

Trim and mount the sample.

Wide Three-Thread Overlock Seam Sample

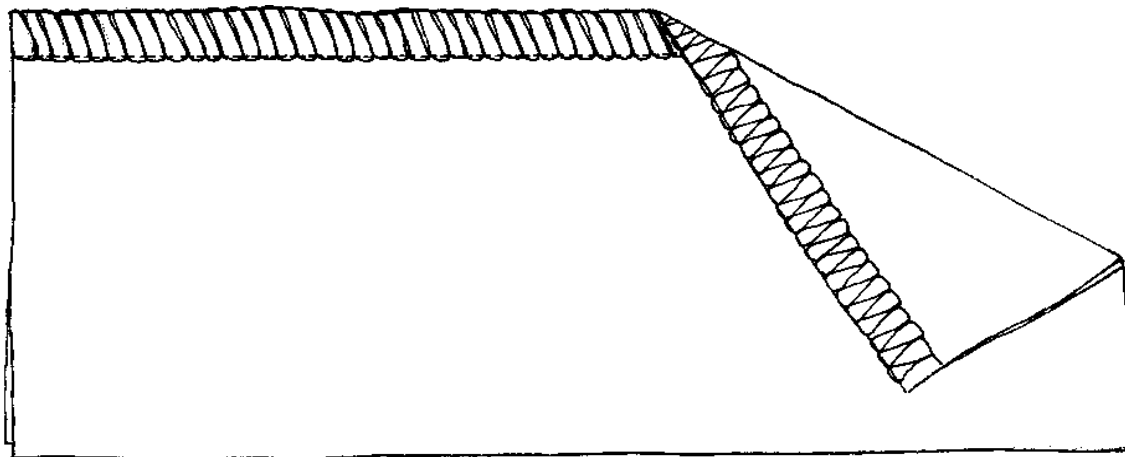

Balanced 3-Thread Overlock - Wide

Upper Looper	3-5	Cutting Width	2-3
Lower Looper	3-5	Stitch Length	2.5mm
Left Needle	3-5	Differential Feed	N
Right Needle	n/a	Rolled Edge Lever	in

Wide Overlock Seam Finish

Fabric 2 pieces medium weight wool, 2½" x 5" each
..... 2 strips bias cut tricot, ¾" x 5" (optional)
Needle 80/12 Universal
Thread 3 cones serger thread
Presser Foot standard
Stitch wide 3-thread overlock

Set serger for a wide 3-thread overlock stitch (left needle). Adjust all settings for a balanced stitch.

Serge one 5" raw edge on *each piece* of fabric. *Optional: For added support, wrap the fabric edge with strips of bias cut tricot or water soluble stabilizer before serging.*

Using your BERNINA® sewing machine and a ⅝" seam allowance, seam the two pieces of fabric together along the serged edges.

Press seam open.

Trim and mount the sample.

Notes

Wide Overlock Seam Finish Sample

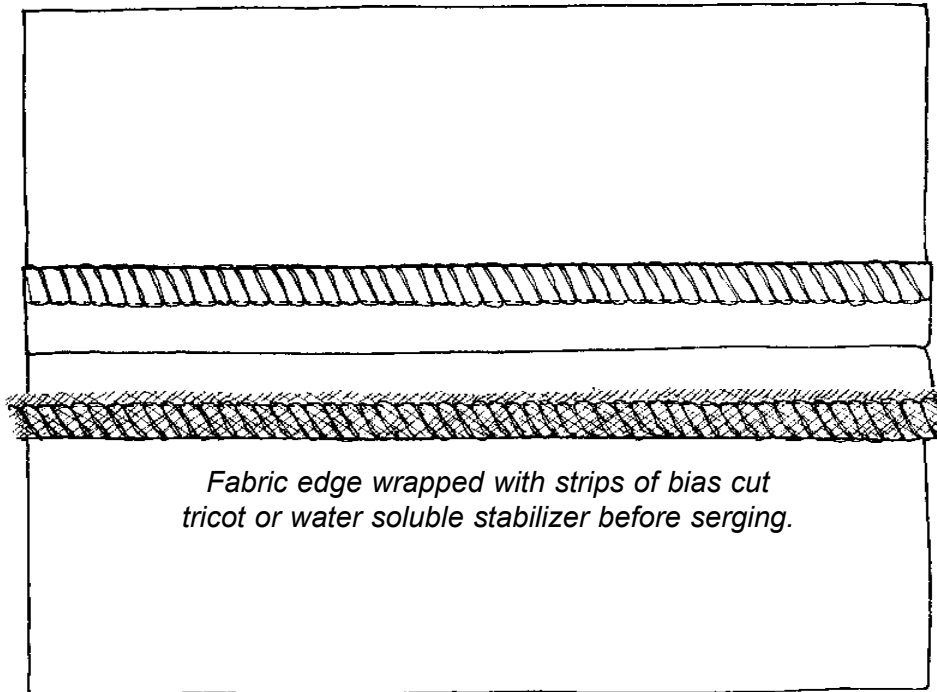

Balanced 3-Thread Overlock - Wide

Upper Loper	3-5	Cutting Width	2-3
Lower Loper	3-5	Stitch Length	2.5mm
Left Needle	3-5	Differential Feed	N
Right Needle	n/a	Rolled Edge Lever	in

Outside Corners

Fabric 2 pieces firm fabric, 4" x 5" each
Needle 80/12 Universal
Thread 3 cones serger thread
Presser Foot standard
Stitch wide 3-thread overlock

OPTION I

Serge one edge of the fabric, stitching off the end of the fabric. Trim the thread tail.

Continue serging around the square, crossing over previous stitching.

Use a seam sealant on the untrimmed thread tails (or use a tapestry needle to weave the thread tail back through the stitching). When the seam sealant is dry, trim the thread tails.

OPTION II

Before serging, trim away the seam allowance ($\frac{1}{4}$ ") for about 2" on each corner of the square.

Beginning at one trimmed corner, serge (cutting $\frac{1}{4}$ " as you sew) to the end of the fabric. Take one stitch off the end of the fabric.

Locate the rolled hem lever on the stitch plate and pull the white lever towards you. This will free the thread from the stitch finger.

Lift the presser foot and carefully pivot the fabric 90° clockwise.

Return the rolled hem lever to normal (away from you).

Place the needle one stitch into the fabric and lower the presser foot.

Continue serging until you are one stitch off the next corner.

Repeat the turning procedure and continue serging.

Trim and mount the samples.

Notes

Outside Corners Samples

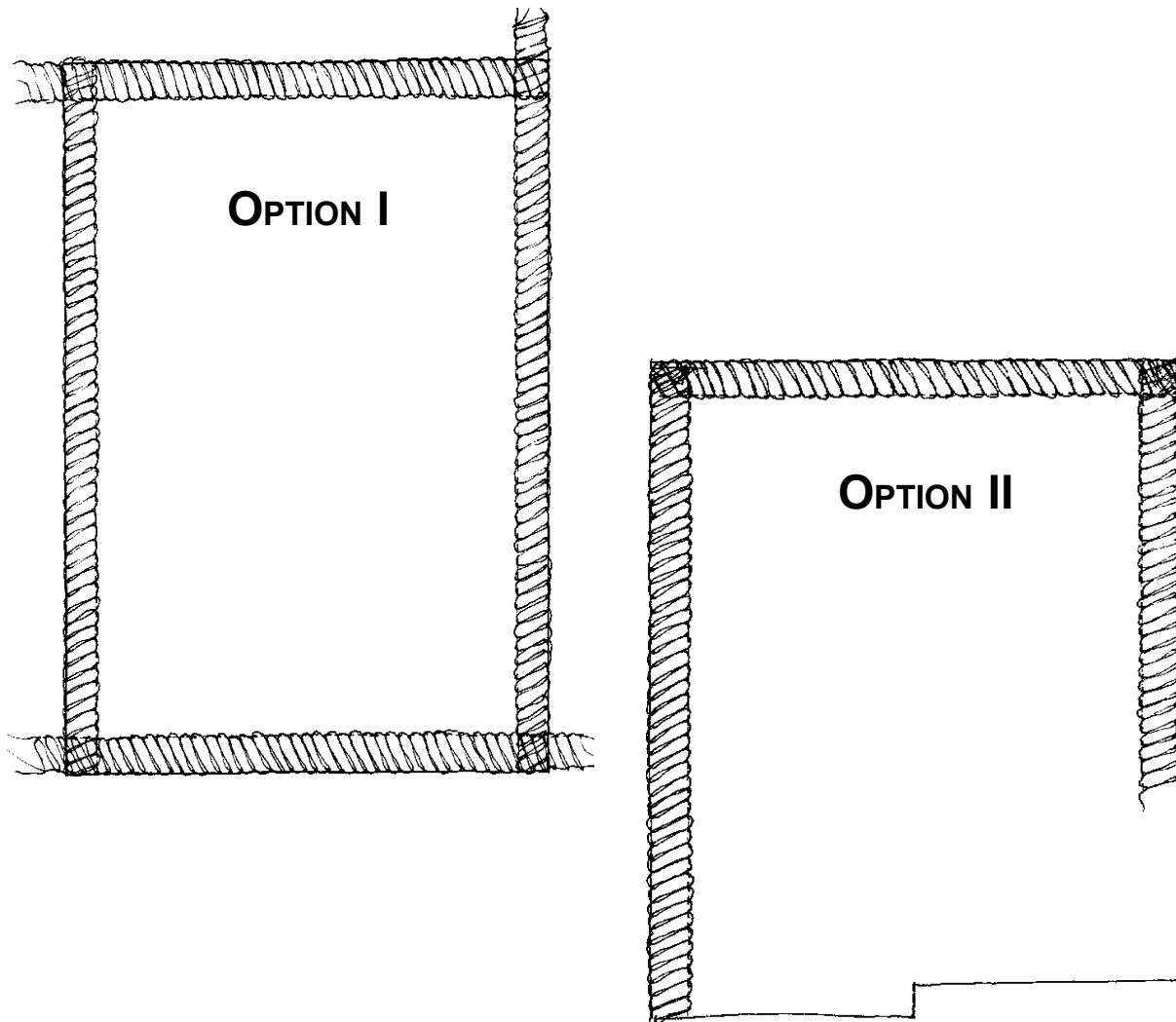

Balanced 3-Thread Overlock - Wide

Upper Loper	3-5	Cutting Width	2-3
Lower Loper	3-5	Stitch Length	2.5mm
Left Needle	3-5	Differential Feed	N
Right Needle	n/a	Rolled Edge Lever	in

Narrow Three-Thread Overlock

Fabric lightweight fabric, 5" x 6"
Needle 80/12 Universal
Thread 3 cones serger thread
Presser Foot standard
Stitch narrow 3-thread overlock

Using the small screwdriver and brush/needle insertion tool, loosen the right needle screw and insert the right needle. *Hint: Place the point of the needle directly above the right needle space of the presser foot, then lift the needle up to place the shank in the correct hole.* Snug right needle screw.

Remove the left needle. Snug the needle set screw after removing the left needle.

Following the diagrams in your owner's manual, thread the serger for a narrow 3-thread overlock stitch. Adjust all settings for a balanced stitch.

Adjust cutting width to 2mm (normal).

Adjust stitch length to 2.5mm (normal).

Fold the fabric in half to 2½" x 6".

Serge along the folded edge of the fabric.

Trim and mount the sample.

Notes

Narrow Three-Thread Overlock Sample

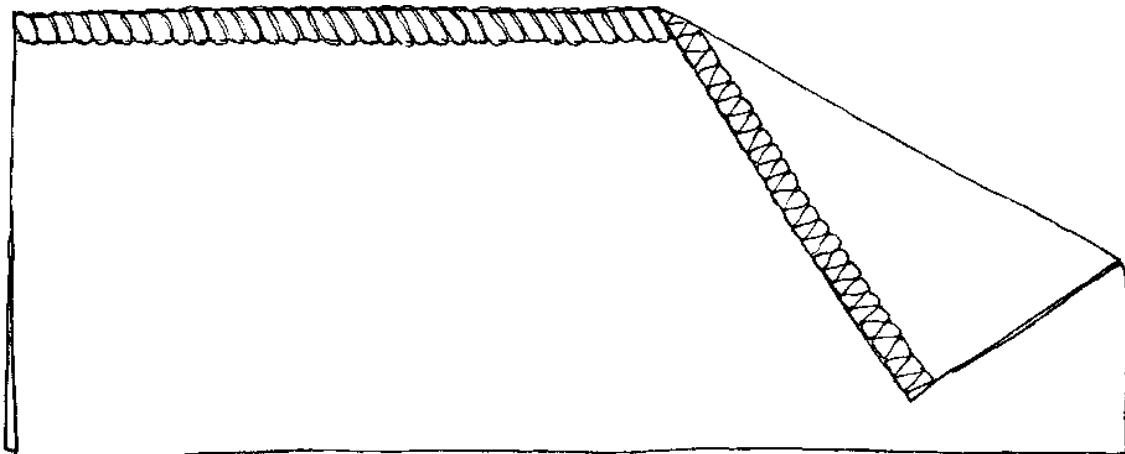

Balanced 3-Thread Overlock - Narrow

Upper Looper	3-5	Cutting Width	2-3
Lower Looper	3-5	Stitch Length	2.5mm
Left Needle	n/a	Differential Feed	N
Right Needle	3-5	Rolled Edge Lever	in

Inside Corners

Fabric 2 pieces firm fabric, 3" x 4" each
Needle 80/12 Universal
Thread 3 cones serger thread
Presser Foot standard
Stitch narrow 3-thread overlock

OPTION I

This technique works well for continuous plackets on sleeves and back neck openings.

Cut an inside corner into the fabric. Snip into the corner $\frac{1}{4}$ " (the width of the stitching). Serge until the knife reaches the end of the cut.

Use the handwheel to lower the needle into the fabric. Lift the presser foot and straighten the corner towards you. Lower the presser foot and continue serging.

OPTION II

Rotate the upper knife up.

Cut an inside corner into the fabric. Line up the left edge of the cut with the lower knife blade. Keep the edge of the fabric even with the lower knife blade as you stitch.

Serge for a few stitches. Turn the handwheel to lower the needle into the fabric. Fold the right side of the corner towards you at about a 45° angle. Serge one stitch beyond the cut edge. Turn the handwheel to lower the needle into the fabric.

Lift the presser foot. Fold the serged edge down and to the left, angling the serged edge about 45°. Pivot the fabric until the raw edge is even with the lower knife blade.

Lower the presser foot and continue stitching. Use the thread cutter to cut the thread chain at the end of the seam. (the upper knife is still disengaged).

Return the upper knife to cutting position.

Trim and mount samples.

Notes

Inside Corners Samples

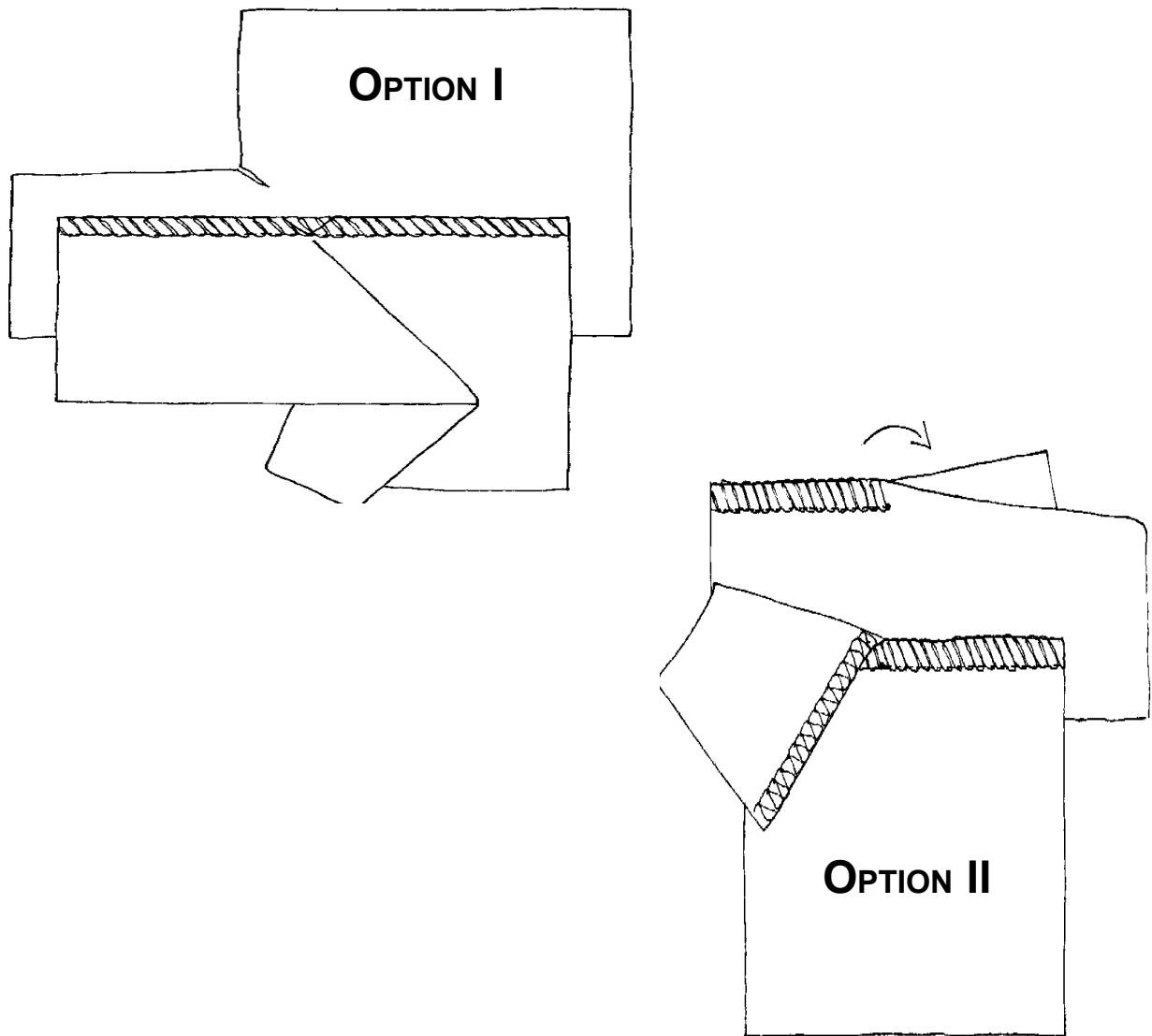

Balanced 3-Thread Overlock - Narrow

Upper Loper	3-5	Cutting Width	2-3
Lower Loper	3-5	Stitch Length	2.5mm
Left Needle	n/a	Differential Feed	N
Right Needle	3-5	Rolled Edge Lever	in

Three-Thread Narrow Seam

Fabric batiste, 5" x 6"
Needle 80/12 Universal
Thread 3 cones serger thread
Presser Foot standard
Stitch 3-thread narrow seam

Following the diagrams in your owner's manual, thread the serger for a 3-thread narrow seam (right needle). Adjust settings as indicated.

Adjust cutting width to 1.5mm.

Adjust stitch length to 1.75mm (normal).

Pull the rolled edge lever toward you (out from the machine).

Fold the fabric in half to 2½" x 6".

Serge along the folded edge of the fabric.

Trim and mount the sample.

Notes

Three-Thread Narrow Seam Sample

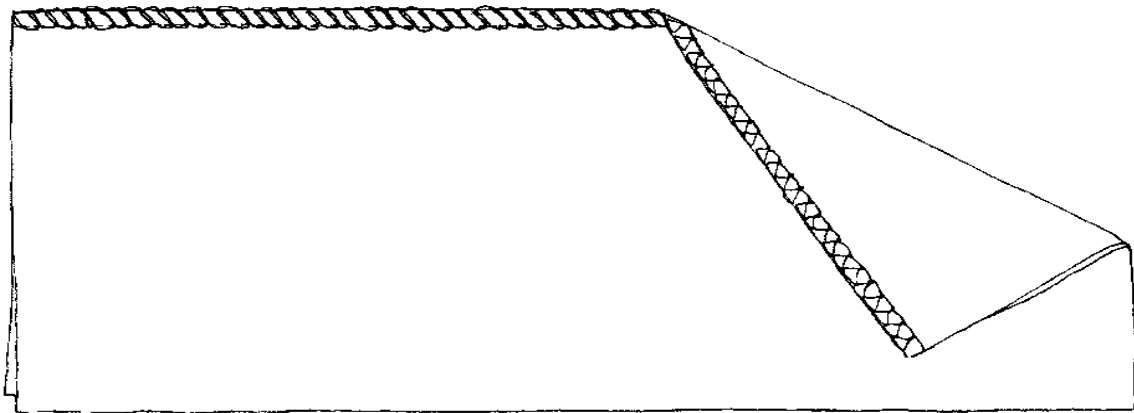

Balanced 3-Thread Narrow Seam

Upper Loper	4-6	Cutting Width	1.5
Lower Loper	4-6	Stitch Length	1.7mm
Left Needle	n/a	Differential Feed	N
Right Needle	3-5	Rolled Edge Lever	out

Turning Tubes

Fabric tricot, 2" x 6"
Needle 75/11 Stretch or Ballpoint
Thread 3 cones serger thread
Presser Foot standard
Stitch narrow 3-thread overlock

Set the serger for a narrow 3-thread overlock stitch (right needle).
Adjust settings as indicated for a balanced stitch.

Adjust stitch length to 1.5mm.

Serge a thread chain several inches longer than the fabric.

Fold the fabric, right sides together, to 1" x 6" encasing the thread chain
against the fold.

With the folded edge aligned with the left edge of the presser foot,
serge the tube. Be careful not to catch the thread chain in the stitching.

After stitching the tube, gently pull on the thread chain and turn the tube
right side out.

Mount the sample.

Notes

Turning Tubes Sample

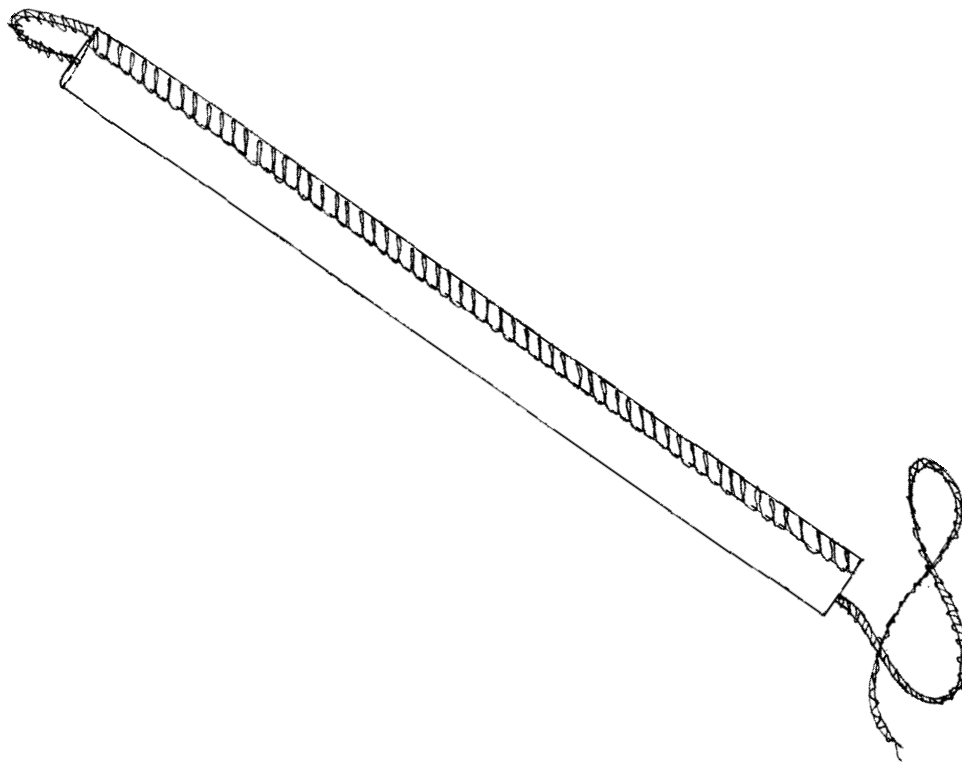

Balanced 3-Thread Overlock - Narrow

Upper Loper	4-6	Cutting Width	2-3
Lower Loper	4-6	Stitch Length	1.5mm
Left Needle	n/a	Differential Feed	N
Right Needle	3-5	Rolled Edge Lever	in

Narrow Three-Thread Flatlock

Fabric sweatshirt fleece, 4" x 6"
Needle 80/12 Universal
Thread 2 cones serger thread
..... 1 cone YLI Jeans Stitch
Presser Foot standard
Stitch narrow 3-thread flatlock

Set serger for a narrow 3-thread flatlock stitch with YLI Jeans Stitch in the upper looper. Set thread tensions as directed in your owner's manual.

Adjust stitch length to 3mm. (If necessary, you can shorten the stitch length slightly to fill in the stitch as you serge.)

Fold the fabric in half, wrong sides together, to 2" x 6".

Optional: Attach the Right Seam Guide to the serger (700D and 800DL will require the Attachment Base). Move the Right Seam Guide halfway between the needle and the stitch finger.

Place the fold under the presser foot. Guide the fabric halfway between the left needle and the right edge of the stitch finger (or against the Right Seam Guide).

Slowly serge the fabric. The looper threads will extend beyond the fabric on the right side of fold.

Gently pull the fabric flat

Return stitch length and thread tension levers to their normal settings.

Trim and mount the sample.

Notes

Narrow Three-Thread Flatlock Sample

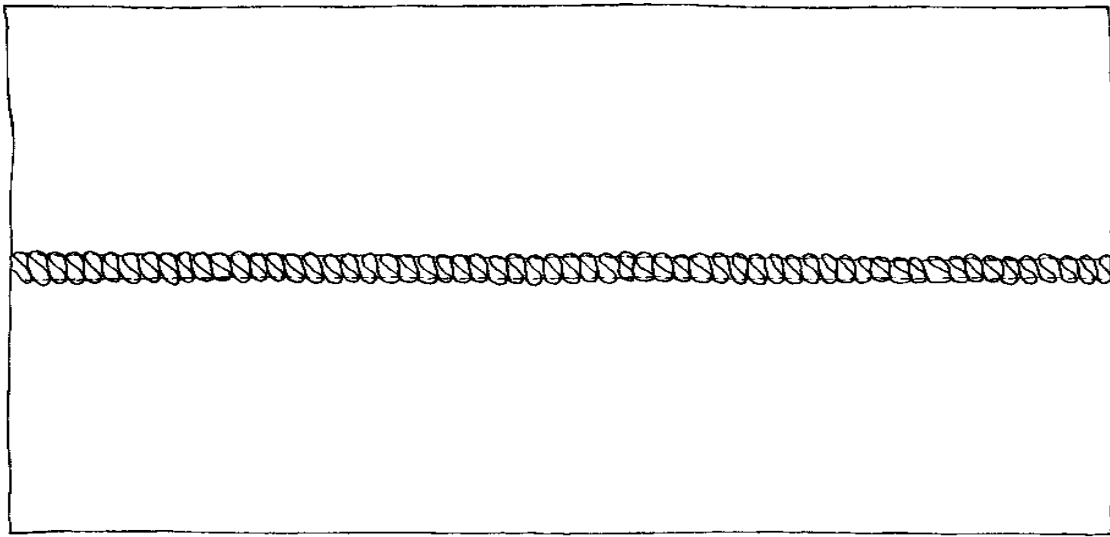

3-Thread Flatlock - Narrow

Upper Looper 3-5
Lower Looper 7-9
Left Needle n/a
Right Needle 1-2

Cutting Width 2-3
Stitch Length 3mm
Differential Feed N
Rolled Edge Lever in

Blindstitch Foot - Blind Hem

Fabric cotton jersey, 5" x 6"
Needle 80/12 Universal
Thread 3 cones serger thread
Presser Foot Blindstitch
Stitch narrow 3-thread flatlock

Notes

Set the serger for a narrow 3-thread flatlock stitch (right needle).

Set needle thread tensions as directed in the instruction leaflet for the Blindstitch Foot.

Adjust the stitch length to 4mm.

Attach the Blindstitch Foot.

Following the instructions in the leaflet for the Blindstitch Foot, fold the fabric for a 1½" blind hem and place the fabric under the foot. Adjust the fabric guide so that the needle just catches the fold in the stitching.

Serge the hem, keeping the fold of the fabric against the guide.

Press the hem.

Trim and mount the sample.

Blindstitch Foot - Blind Hem Sample

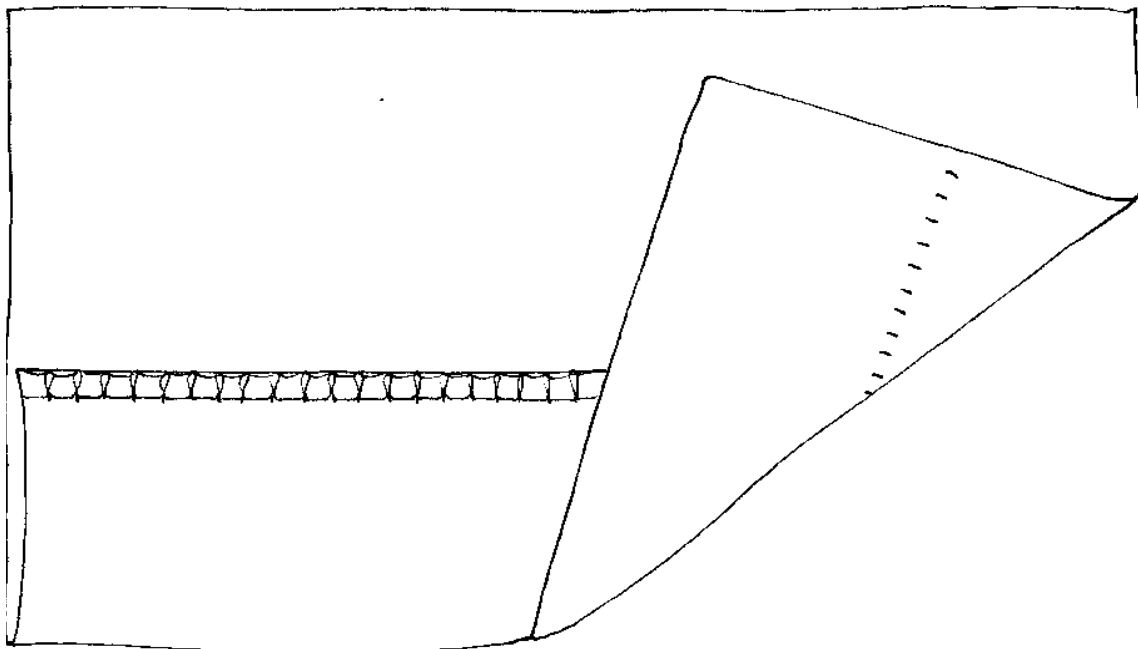

3-Thread Flatlock - Narrow

Upper Looper 3-5
Lower Looper 7-9
Left Needle n/a
Right Needle 1-2

Cutting Width 2-3
Stitch Length 3mm
Differential Feed N
Rolled Edge Lever in

Blindstitch Foot - Hand-Picked or Drapery Blind Hem

Fabric mediumweight fabric, 5" x 6"
Needle 80/12 Universal
Thread 3 cones serger thread
Presser Foot Blindstitch
Stitch narrow 3-thread flatlock

Set the serger for a narrow 3-thread flatlock stitch (right needle). Set needle thread tension levers as directed in the instruction leaflet for the Blindstitch Foot.

Adjust the stitch length to 3.5mm.

Attach the Blindstitch Foot.

Turn up a double folded 1" hem. Fold the remaining fabric under so that no fabric extends beyond the upper edge of the hem.

Place the fabric under the presser foot. The fold of the fabric should rest against the guide. Adjust the fabric guide so that the needle just catches the fold in the stitching.

Serge the hem, keeping the fold of the fabric against the guide.

Press the hem.

Trim and mount the sample.

Notes

Hand-Picked or Drapery Blind Hem Sample

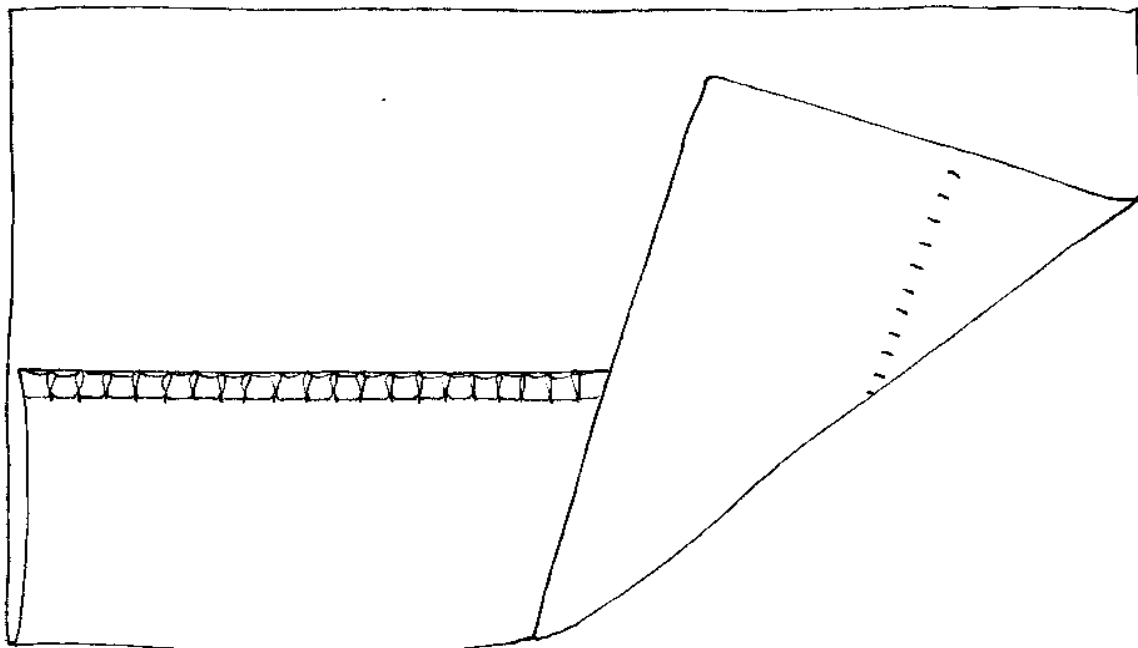

3-Thread Flatlock - Narrow

Upper Loper 3-5
Lower Loper 7-9
Left Needle n/a
Right Needle 1-2

Cutting Width 2-3
Stitch Length 3mm
Differential Feed N
Rolled Edge Lever in

Blindstitch Foot - Decorative Tucks

Fabric batiste, 5" x 6"
Needle 70/10 Sharp or Microtex
Thread 3 cones serger thread
Presser Foot Blindstitch
Stitch narrow 3-thread overlock

Set the serger for a narrow 3-thread overlock stitch (right needle).
Adjust settings as indicated.

Pull the rolled hem lever towards you.

Adjust the stitch length to 1.5mm.

Attach the Blindstitch Foot.

Move the fabric guide just to the left of the knife line on the stitch plate.

Stiffen the batiste with spray starch or fabric stiffener.

Mark three lines 1" apart across the fabric.

Fold the fabric wrong sides together along one marked line and place
the fabric under the presser foot with the fold against the guide.

Serge the tuck; repeat for the two remaining marked lines.

Return the rolled hem lever to the normal serging position.

Trim and mount the sample.

Notes

Blindstitch Foot - Decorative Tucks Sample

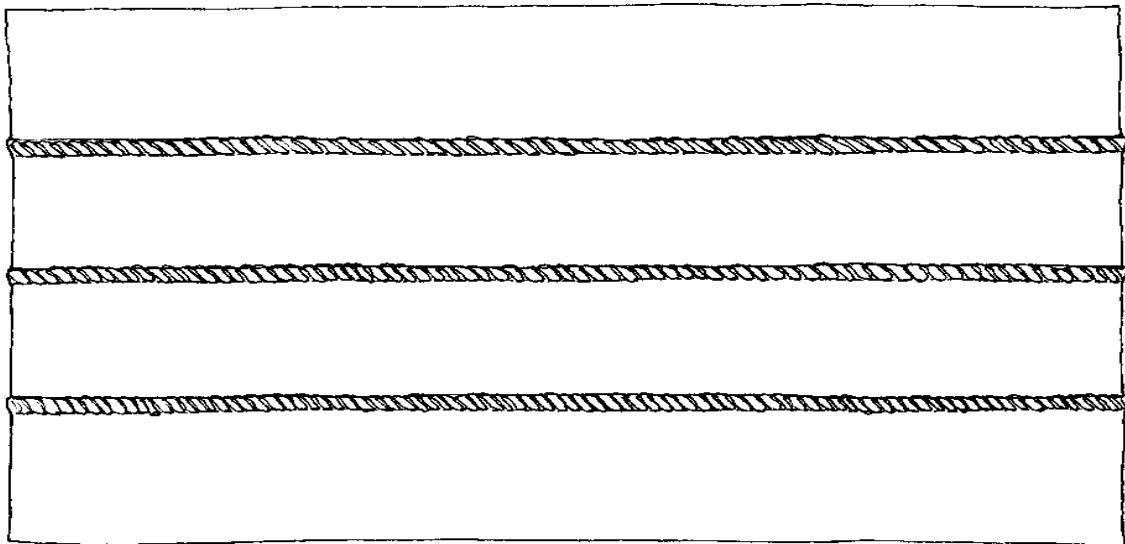

3-Thread Overlock - Narrow

Upper Loper 4-6
Lower Loper 4-6
Left Needle n/a
Right Needle 3-5

Cutting Width 2-3
Stitch Length 1.5mm
Differential Feed N
Rolled Edge Lever in

Blindstitch Foot - Joining Lace to Lace

Fabric 2 pieces of flat edging lace, 6" each
Needle 70/10 Sharp or Microtex
Thread 3 cones serger thread
Presser Foot Blindstitch
Stitch narrow 3-thread overlock

Set the serger for a narrow 3-thread overlock stitch (right needle).
Adjust settings as indicated.

Loosen the right needle tension slightly.

Pull the rolled hem lever towards you.

Adjust the stitch length to 1.5mm.

Attach the Blindstitch Foot.

Move the fabric guide just to the left of the knife line on the stitch plate.

Stiffen the lace with spray starch or fabric stiffener.

With right sides together, place the header of the laces under the
presser foot against the guide.

Serge the laces together.

Gently pull the lace flat and press.

Trim and mount the sample

Notes

Blindstitch Foot - Joining Lace to Lace Sample

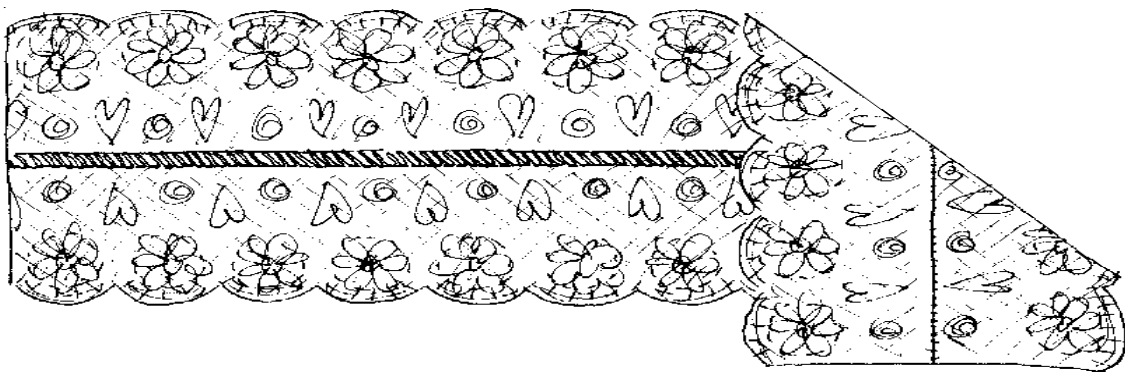

3-Thread Overlock - Narrow

Upper Loper 4-6
Lower Loper 4-6
Left Needle n/a
Right Needle 2-5

Cutting Width 2-3
Stitch Length 1.5mm
Differential Feed N
Rolled Edge Lever in

Three-Thread Rolled Hem

Fabric mediumweight fabric, 3" x 6"
Needle 80/12 Universal
Thread 2 cones serger thread
..... 1 cone YLI Woolly Nylon
Presser Foot standard
Stitch 3-thread rolled edge

Set the serger for a narrow 3-thread overlock stitch (right needle) with Woolly Nylon in the upper looper. Adjust settings as indicated in your owner's manual.

Pull the rolled hem lever towards you.

Adjust the stitch length to 1.75mm.

Set cutting width at 2 (normal).

Place the fabric under the presser foot and serge along one 6" edge.

Return stitch length and thread tension levers to normal.

Return the rolled hem lever to normal sewing position.

Trim and mount the sample.

Notes

Three-Thread Rolled Hem Sample

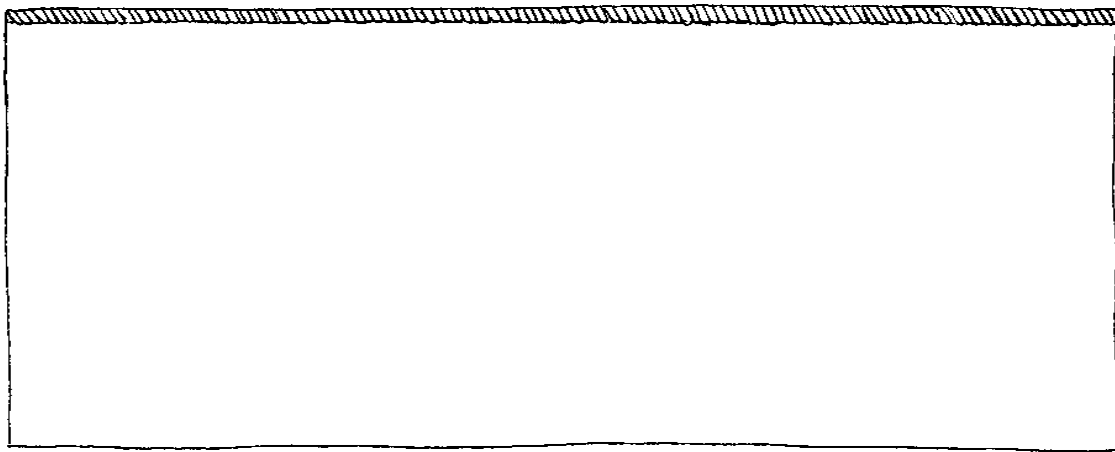

3-Thread Rolled Edge

Upper Looper 3-5
Lower Looper 7-9
Left Needle n/a
Right Needle 3-5

Cutting Width 2-3
Stitch Length 1.75mm
Differential Feed N
Rolled Edge Lever out

Cording Foot - Bias Ruffle

Fabric mediumweight fabric, 3" x 18", cut on bias
..... nylon fishing line, 15-20# test, 24"
Needle 80/12 Universal
Thread 2 cones serger thread
..... 1 cone YLI Woolly Nylon
Presser Foot Cording
Stitch 3-thread rolled edge

Set the serger for a 3-thread rolled edge (right needle) with Woolly Nylon in the upper looper. Adjust settings as directed in your owner's manual.

Pull the rolled hem lever towards you.

Adjust the stitch length to 1.75mm.

Set cutting width at 1.5.

Attach the Cording Foot.

Following the directions in the instruction leaflet for the Cording Foot, insert the nylon fishing line through the guide.

Place the fabric under the presser foot and serge along one 18" edge stretching the fabric edge as you sew.

Return stitch length and thread tension levers to normal.

Return the rolled hem lever to normal sewing position.

Trim and mount the sample.

Notes

Cording Foot - Bias Ruffle Sample

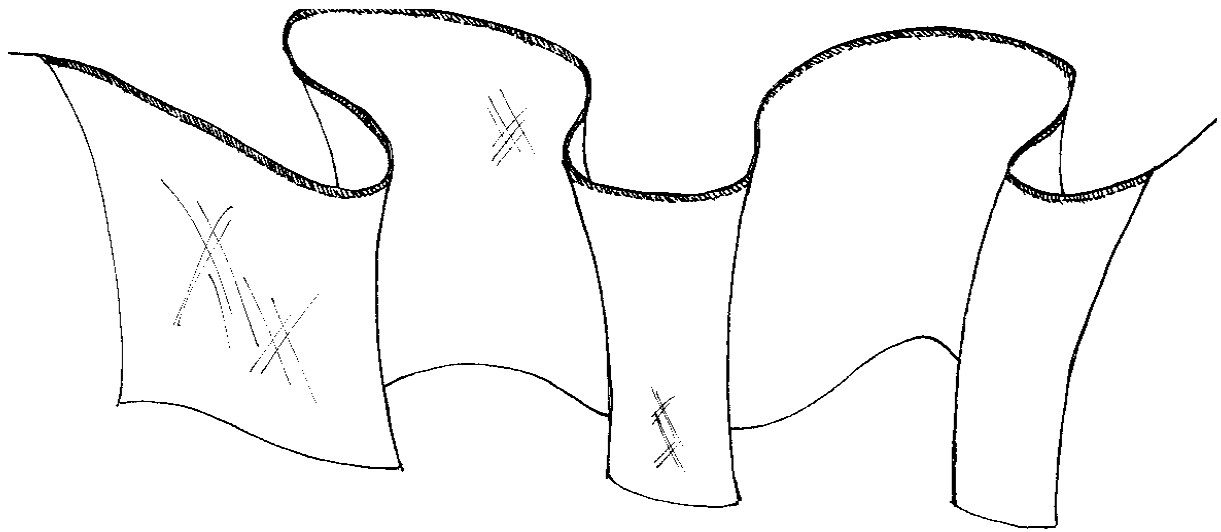

3-Thread Rolled Edge

Upper Loper 3-5
Lower Loper 7-9
Left Needle n/a
Right Needle 3-5

Cutting Width 2-3
Stitch Length 1.75mm
Differential Feed N
Rolled Edge Lever out

Cording Foot - Wire-Edged Fabric

Fabric mediumweight fabric, 3" x 18"
Other 28 gauge floral wire, two 24" lengths
Needle 80/12 Universal
Thread 2 cones serger thread
..... 1 cone YLI Woolly Nylon
Presser Foot Cording
Stitch 3-thread rolled edge

Set the serger for a 3-thread rolled edge (right needle) with Woolly Nylon in the upper looper. Adjust settings as indicated.

Pull the rolled hem lever towards you.

Adjust the stitch length to 1.75mm.

Set cutting width at 1.5.

Attach the Cording Foot. Following the direction in the instruction leaflet for the Cording Foot, insert the wire through the guides.

Place the fabric under the presser foot and serge along one 18" edge, feeding the wire through the foot as you serge.

Use wire cutters to cut the wire. **Do not use the serger knives.**

Repeat for the other 18" edge of the fabric.

Return stitch length and thread tension levers to normal.

Return the rolled hem lever to normal sewing position.

Secure the thread tails with a seam sealant. When the sealant is dry, cut the thread tails. Use wire cutters to trim the wire, if needed.

Tie the wired fabric into a bow.

Trim and mount the sample.

Notes

Cording Foot - Wire-Edged Fabric Sample

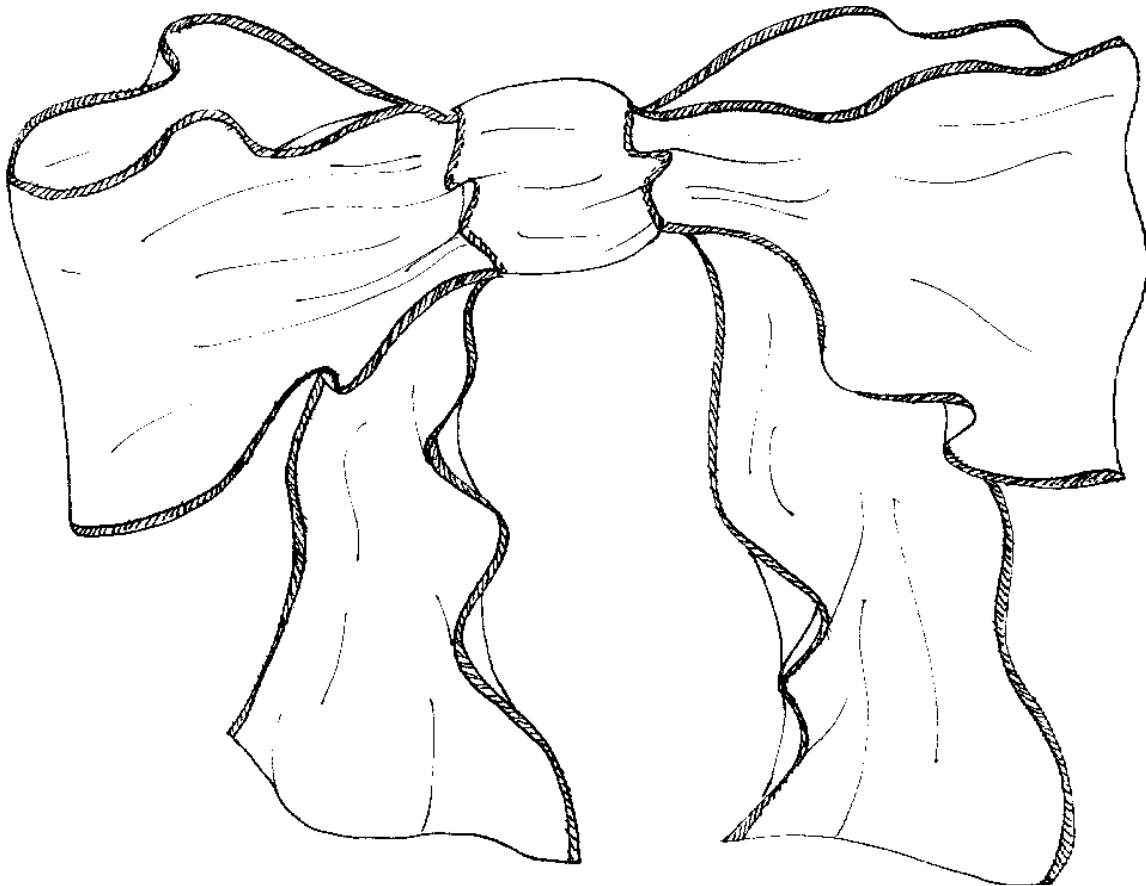

3-Thread Rolled Edge

Upper Loper 3-5
Lower Loper 7-9
Left Needle n/a
Right Needle 3-5

Cutting Width 2-3
Stitch Length 1.75mm
Differential Feed N
Rolled Edge Lever out

Class 3

Three-Thread Techniques

Product Reference List

- Feet-ures, Volume 2 (Unit M)
- Serger Technique Reference Book*
- Carrying Case
- Cording Foot
- Right Seam Guide
- Attachment Base (700D and 800DL only)
- Seams Great bias cut tricot
- ½" Cotton Braid Elastic
- ½" Clear Elastic
- ¼" Twill Tape
- ¼" Ribbon
- Wavy Cutting Blade
- Clear Quilters' Ruler
- Cutting Mat
- BERNINA® Ironing System
- Large Eye Tapestry/Darning Needles
- Vacuum Cleaner Attachment
- 1" Wide Cosmetic Brush or Mini-Duster
- BERNINA® Thread Storage Box (clear)
- BERNINA® Deluxe Accessory Box
- Scrap catcher
- Serger Needle/Looper Threader
- 6" Ruler/Gauge
- Serger thread (Mettler Metrocor, YLI Elite)
 - color _____
 - color _____
 - color _____
 - color _____
- Woolly Nylon texturized thread
 - color _____
 - color _____
 - color _____
 - variegated _____
- YLI Jeans Stitch thread
 - color _____
 - color _____
 - color _____
 - variegated _____
- Needles
 - Stretch
 - size _____
 - size _____
 - Ballpoint
 - size _____
 - size _____
 - Sharp
 - size _____
 - size _____
 - Microtex
 - size _____
 - size _____
 - Universal
 - size _____
 - size _____

Class 4

Miscellaneous Techniques

Class Overview

Installing the Upper Looper Converter (2-Thread Adapter)

Specialty Stitches using Upper Looper Converter

- 1 3-Thread Super Stretch Stitch
- 2 3-Thread Super Stretch Stitch - Attaching Elastic
- 3 Wide 2-Thread Flatlock
- 4 Serging with Heavy Decorative Threads
- 5 2-Thread Rolled Hem
- 6 2-Thread Wrapped Edge

Multi-Purpose Foot with Guide

- 7 Multi-Purpose Foot with Guide - Corded Piping
- 8 Multi-Purpose Foot with Guide - Creating & Attaching Corded Piping
- 9 Multi-Purpose Foot with the Gathering Attachment
- 10 Multi-Purpose Foot - Attaching Pre-Strung Beads

Optional Presser Feet & Accessories (used in this unit)

Multi-Purpose Foot with Guide

Two grooves for guiding cord, sequins, beads, etc.

Gathering Attachment

For gathering one layer, or gathering to a flat piece

Attachment Base (700D and 800DL only)

Needed to attach some accessories to serger

Seam Guides

Right Seam Guide

Multi-Purpose Foot Guide

This class is formatted for owners of the following models of BERNINA® overlock machines:

- 700 D
- 800 DL
- 1100D
- 1100DA
- 1200DA
- 1300DC
- 2500DCET

3-Thread Super Stretch Stitch

Fabric cotton or nylon Lycra, 5" x 6"
Needle 80/12 Stretch or 75/11 Ballpoint
Thread 2 cones serger thread
..... 1 cone YLI Woolly Nylon
Presser Foot standard
Stitch 3-thread super stretch

Attach the 2-thread adapter (upper looper converter) to the upper looper. *Note: This is an optional accessory for the 700D.*

Following the instructions in your owner's manual, thread the serger for a super stretch stitch using Woolly Nylon in the lower looper. Adjust settings as indicated.

Adjust the stitch length to 2.5mm (normal).

Fold the Lycra in half to 2½" x 6".

Place the fabric under the foot and serge, cutting off the fold.

Trim and mount the sample

Notes

3-Thread Super Stretch Stitch Sample

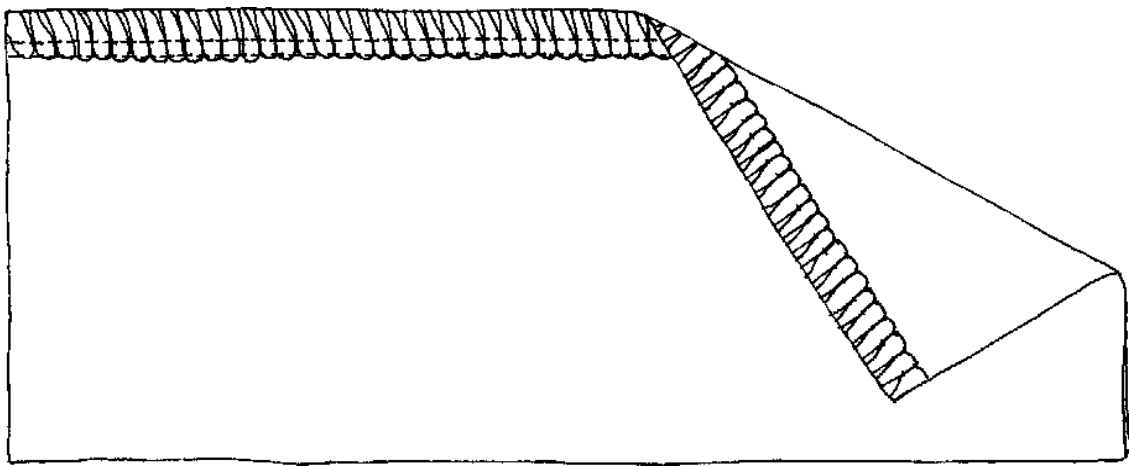

3-Thread Super Stretch Stitch

Upper Loper converter
Lower Loper 3-5
Left Needle 3-5
Right Needle 3-5

Cutting Width 2-3
Stitch Length 2.5mm
Differential Feed N
Rolled Edge Lever in

3-Thread Super Stretch Stitch - Attaching Elastic

Fabric cotton or nylon Lycra, 3" x 6"
Other 12" length of nylon or cotton elastic braid
Needle 80/12 Stretch or 75/11 Ballpoint
Thread 2 cones serger thread
..... 1 cone YLI Woolly Nylon
Presser Foot Elasticator
Stitch 3-thread super stretch

Attach the 2-thread adapter (upper looper converter) to the upper looper. *Note: This is an optional accessory for the 700D.*

Following the instructions in your owner's manual thread the serger for a Super Stretch Stitch using Woolly Nylon in the lower looper.

Adjust the stitch length to 4mm.

Increase the presser foot pressure.

Attach the Elasticator Foot. Turn the pressure adjustment screw (on the roller guide) clockwise to set pressure as desired.

Raise the roller guide and insert the elastic into the slot at the front of the presser foot.

Place the fabric under the foot and serge, cutting off the fold.

Trim and mount the sample.

Notes

Attaching Elastic Sample

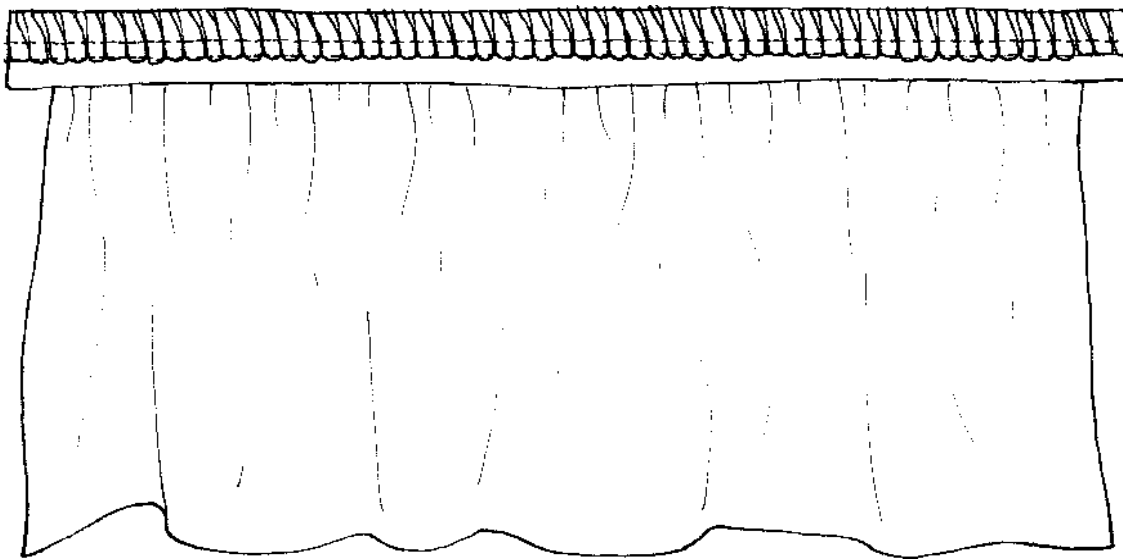

3-Thread Super Stretch Stitch

Upper Loper converter
Lower Loper 3-5
Left Needle 3-5
Right Needle 3-5

Cutting Width 2-3
Stitch Length 4mm
Differential Feed N
Rolled Edge Lever in

Wide Two-Thread Flatlock

Fabric mediumweight cotton, 4" x 6"
Needle 80/12 Universal
Thread 1 cone serger thread
..... 1 cone YLI Jeans Stitch
Presser Foot standard
Stitch wide 2-thread flatlock

Attach the 2-thread adapter (upper looper converter) to the upper looper. *Note: This is an optional accessory for the 700D.*

Following the instructions in your owner's manual, thread the serger for a 2-thread flatlock stitch using Jeans Stitch in the lower looper. Adjust settings as indicated.

Adjust the stitch length to 2.5mm.

Fold the fabric in half to 2" x 6" and position it halfway between the left needle and the stitch finger. *Optional: Attach the Right Seam Guide. Move the Right Seam Guide halfway between the needle and the stitch finger.*

Slowly serge the fabric. The looper threads will extend beyond the fabric on the right side of fold.

Gently pull the fabric flat

Return stitch length and thread tension levers to normal.

Trim and mount the sample.

Notes

Wide Two-Thread Flatlock Sample

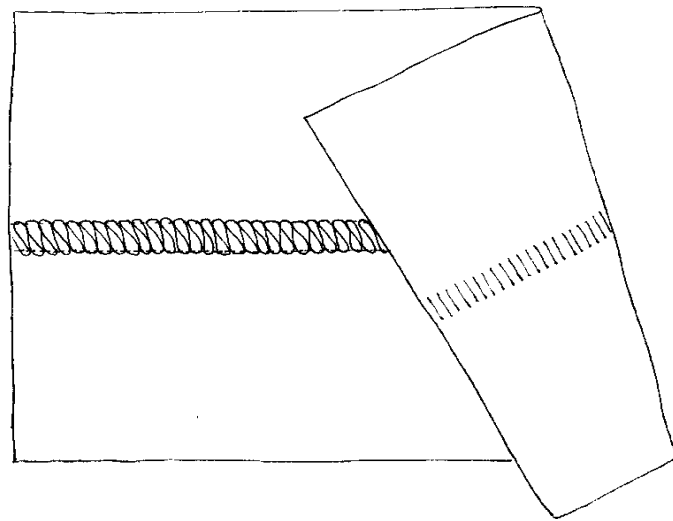

2-Thread Flatlock - Wide

Upper Looper converter
Lower Looper 3-5
Left Needle 1-2
Right Needle n/a

Cutting Width 2-3
Stitch Length 2.5mm
Differential Feed N
Rolled Edge Lever in

Serging with Heavy Decorative Threads

Fabric 3 pieces mediumweight cotton, 4" x 6" each
Needle 90/14 Universal
Thread 1 cone serger thread
..... 1 cone YLI Pearl Crown Rayon
..... 1 cone YLI Designer 6
Presser Foot standard
Stitch wide 2-thread flatlock

Attach the 2-thread adapter (upper looper converter) to the upper looper. *Note: This is an optional accessory for the 700D.*

Following the instructions in your owner's manual, thread the serger for a wide 2-thread flatlock stitch using decorative thread in the lower looper. Adjust settings as indicated.

Adjust the stitch length to 4mm. (If needed, you can slowly shorten the stitch length as you serge to fill in the flatlock stitch).

Serge the sample. If the tension on the decorative thread is too tight, decrease the looper tension and try again. If the thread tension on the decorative thread is still too tight, remove the thread from the last thread guide and try again.

Experiment with the suggested threads, adjusting thread tension and/or bypassing thread guides as needed.

Press, trim, and mount the samples on the following page.

Notes

No Speeding!

To avoid uneven stitches, tangled threads, hiccups, and other imperfections, always sew slowly when working with decorative threads.

Serging with Decorative Threads Sample

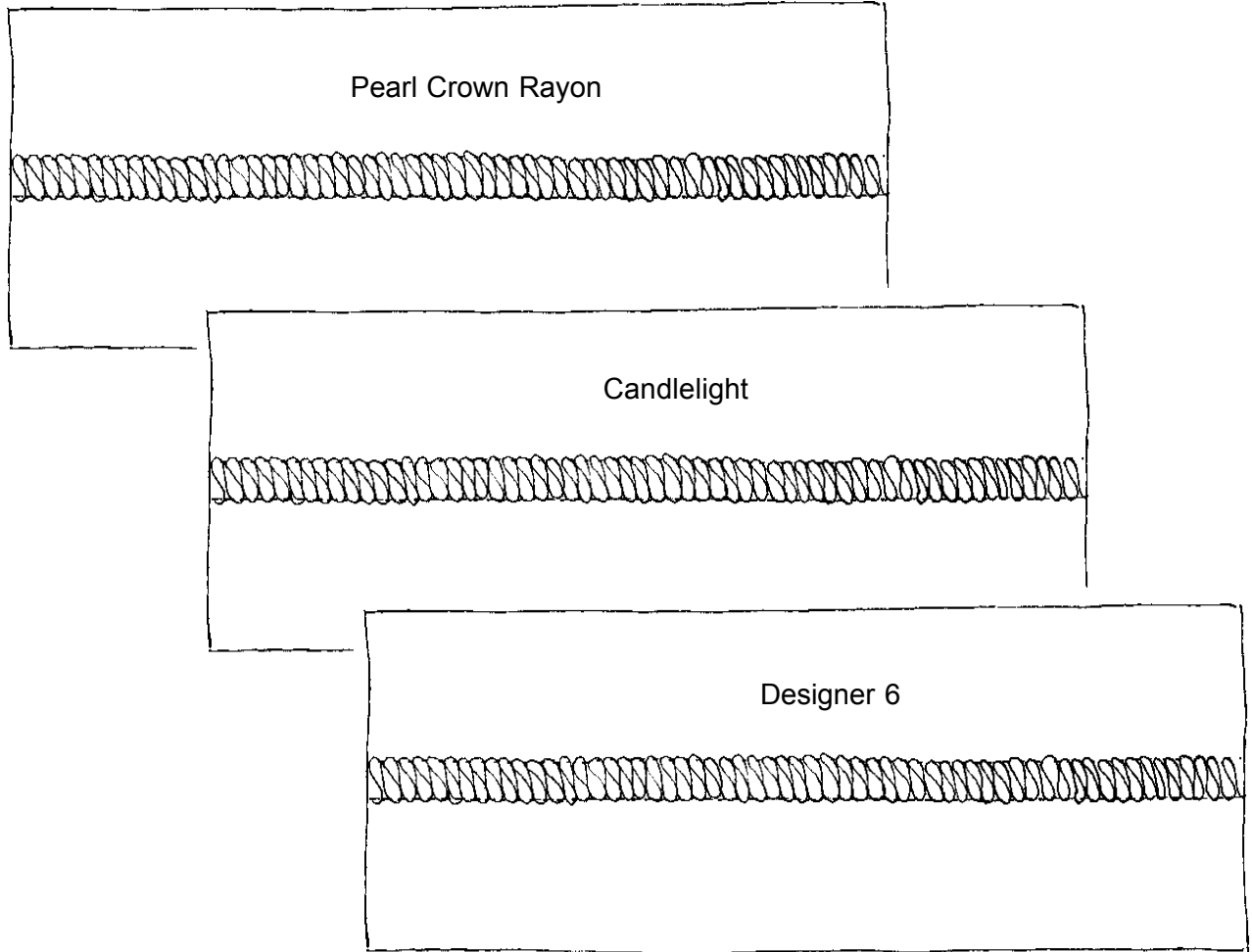

2-Thread Flatlock - Wide

Upper Looper	converter	Cutting Width	2-3
Lower Looper	3-5	Stitch Length	4mm
Left Needle	1-2	Differential Feed	N
Right Needle	n/a	Rolled Edge Lever	in

Two-Thread Rolled Hem

Fabric batiste, 4" x 6"
Needle 70/10 Sharp or Microtex
Thread 2 cones lightweight serger thread
Presser Foot standard
Stitch 2-thread rolled edge (right needle)

Attach the 2-thread adapter (upper looper converter) to the upper looper. *Note: This is an optional accessory for the 700D.*

Following the instructions in your owner's manual, thread the serger for a 2-thread flatlock stitch. Adjust settings as directed.

Pull the rolled hem lever towards you.

Adjust the stitch length to 1.75mm.

Set cutting width at 2mm (normal).

Place the fabric under the presser foot and serge along one 6" edge, trimming about 1/8" from the raw edge.

Return stitch length and thread tension levers to normal.

Trim and mount the sample.

Notes

Two-Thread Rolled Hem Sample

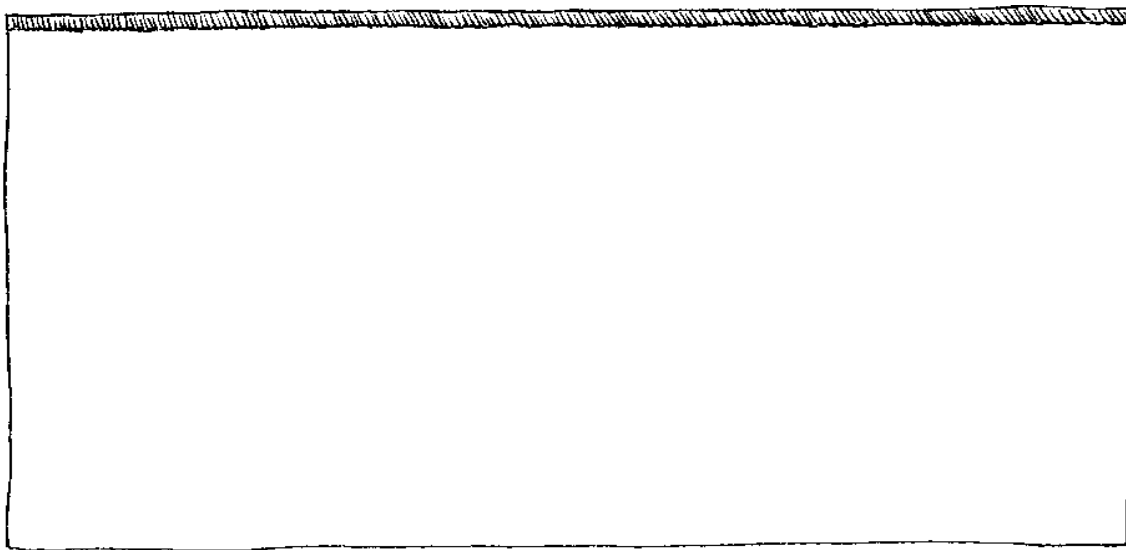

2-Thread Rolled Edge

Upper Looper converter
Lower Looper 3-5
Left Needle n/a
Right Needle 3-5

Cutting Width 1-1.5
Stitch Length 1-1.8mm
Differential Feed N
Rolled Edge Lever out

Two-Thread Wrapped Edge

Fabric heavy wool or polar fleece, 5" x 6"
Needle 80/12 Universal
Thread 1 cone serger thread
..... 1 cone YLI Jeans Stitch
Presser Foot standard
Stitch wide 2-thread wrapped edge (left **or** right needle)

Attach the 2-thread adapter (upper looper converter) to the upper looper. *Note: This is an optional accessory for the 700D.*

Following the instructions in your owner's manual thread the serger for a 2-thread wrapped edge using Jeans Stitch in the lower looper. Adjust settings as indicated.

Place the fabric under the presser foot and serge along one edge; adjust the differential feed if needed.

If the Jeans Stitch does not wrap around the edge completely, the thread tension may be too tight. Reduce the looper thread tension. If the thread still does not wrap, remove the Jeans Stitch thread from the uppermost thread guide and try again.

Wrap-stitch the other three edges of the fabric.

Use seam sealant to seal the stitching at the corners. When the sealant is dry, trim the thread tails.

Return stitch length and thread tension levers to normal.

Trim and mount the sample.

Notes

Two-Thread Wrapped Edge Sample

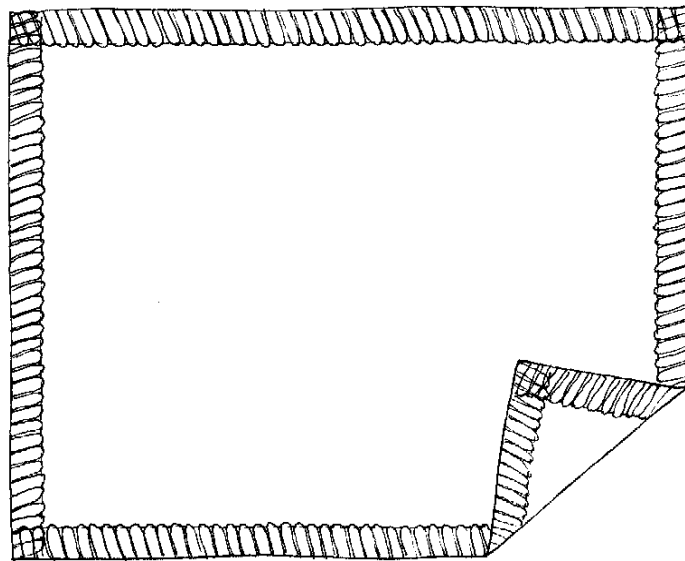

2-Thread Wrapped Edge - Wide

Upper Loper converter
Lower Loper 3-5
Left Needle 3-5
Right Needle n/a

Cutting Width 2-3
Stitch Length 2.5mm
Differential Feed N
Rolled Edge Lever in

Multi-Purpose Foot with Guide - Corded Piping

Fabric mediumweight cotton bias strip, 2" x 8"
Other 12" length of 3/8" cotton filler cord
Needle 80/12 Universal
Thread 4 cones serger thread
Presser Foot Multi-Purpose Foot with Guide
Stitch 4-thread overlock

Notes

Following the instructions in your owner's manual, thread the serger for a 4-thread overlock stitch using both needles. Adjust all settings for a balanced stitch.

Set stitch length to 3.5mm.

Attach the Multi-Purpose Foot and Guide following the directions in the instruction manual for the Multi-Purpose Foot with Guide. *Note: 700D and 800DL also need the Attachment Base.*

Insert the filler cord into the guide.

Wrap the bias strip around the cord and place the wrapped cord in the groove under the foot.

Serge the covered cord.

Mount the sample.

Multi-Purpose Foot - Corded Piping Sample

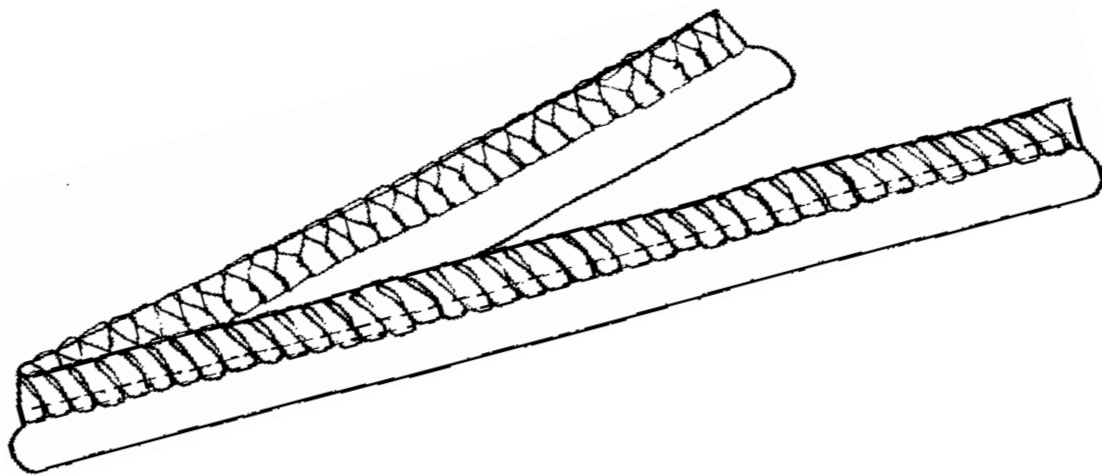

Balanced 4-Thread Overlock

Upper Loper	3-5	Cutting Width	2-3
Lower Loper	3-5	Stitch Length	3.5mm
Left Needle	3-5	Differential Feed	N
Right Needle	3-5	Rolled Edge Lever	in

Multi-Purpose Foot with Guide - Creating & Attaching Corded Piping

Fabric mediumweight cotton bias strip, 2" x 8"
..... mediumweight cotton, 3" x 8"
Other 12" length of 3/8" cotton filler cord
Needle 80/12 Universal
Thread 4 cones serger thread
Presser Foot Multi-Purpose Foot with Guide
Stitch 4-thread overlock

Notes

Following the instructions in your owner's manual, thread the serger for a 4-thread overlock stitch using both needles. Adjust settings for a balanced stitch.

Set stitch length to 3mm.

Attach the Multi-Purpose Foot and Guide following the directions in the instruction manual for the Multi-Purpose Foot with Guide. *Note: 700D and 800DL also need the Attachment Base.*

Place the 3" x 8" fabric under the foot.

Insert the cord into the guide.

Wrap the bias strip around the cord and place the wrapped cord in the groove under the foot and on top of the other fabric.

Serge, making the covered cord and attaching it to the fabric strip in one stitching.

Press the seam allowance to the wrong side of the fabric strip.

Mount the sample.

Multi-Purpose Foot with Guide - Creating & Attaching Corded Piping Sample

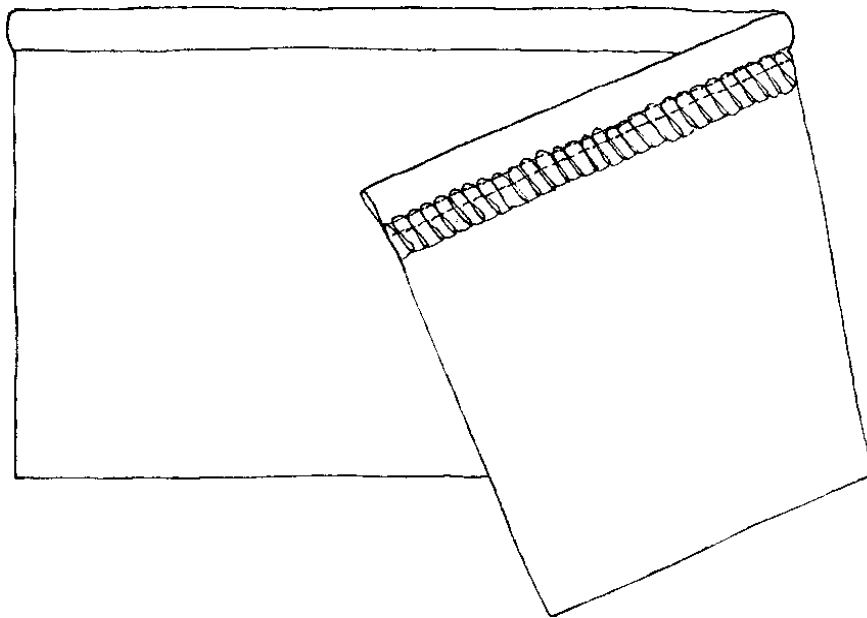

Balanced 4-Thread Overlock

Upper Looper 3-5
Lower Looper 3-5
Left Needle 3-5
Right Needle 3-5

Cutting Width 2-3
Stitch Length 3mm
Differential Feed N
Rolled Edge Lever in

Multi-Purpose Foot with the Gathering Attachment

Fabric	mediumweight cotton bias strip, 2" x 8"
.....	mediumweight cotton, 3" x 18"
Other	12" length of 3/8" cotton filler cord
Needle	80/12 Universal
Thread	4 cones serger thread
Presser Foot	Multi-Purpose Foot with Guide
Other	Gathering Attachment
Stitch	4-thread overlock

Notes

Following the instructions in your owner's manual, thread the serger for a 4-thread overlock stitch using both needles. Adjust settings for a balanced stitch.

Set stitch length to 3mm.

Adjust differential feed to 2.

Attach the Multi-Purpose Foot (no guide), following the directions in the instruction manual for the Multi-Purpose Foot with Guide.

Attach the Gathering Attachment following the directions in the instruction leaflet. *Note: 700D and 800DL also need the Attachment Base.*

Wrap the bias strip around the cord and place the wrapped cord in the groove under the foot.

Take 2 or 3 stitches into the fabric and lower the needles into the fabric.

Place the 3" x 18" fabric under the Gathering Attachment and next to the needles.

Serge, covering the cord, gathering the fabric strip and seaming all layers together.

Mount the sample on the following page.

Multi-Purpose Foot with the Gathering Attachment Sample

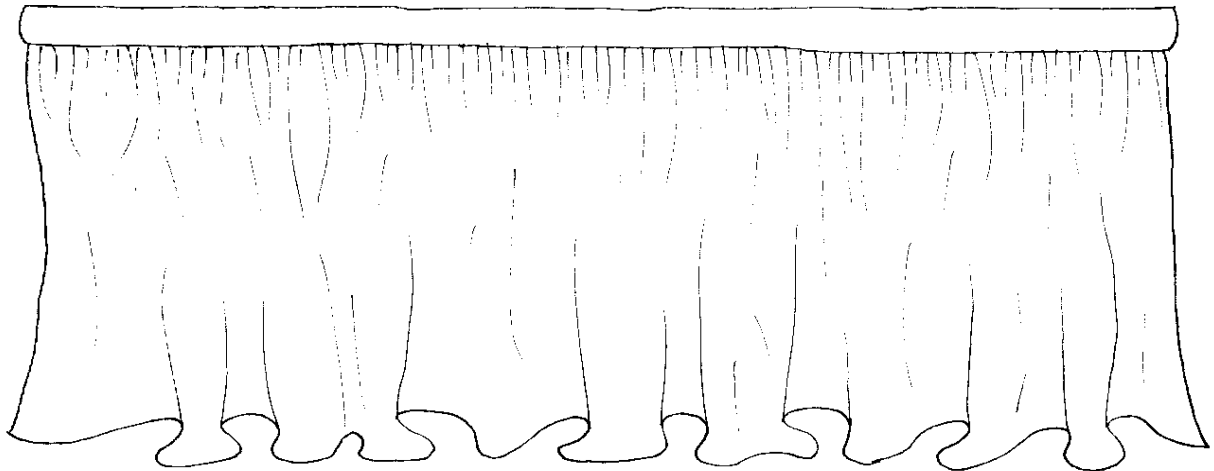

Balanced 4-Thread Overlock

Upper Loper 3-5
Lower Loper 3-5
Left Needle 3-5
Right Needle 3-5

Cutting Width 2-3
Stitch Length 3mm
Differential Feed 2
Rolled Edge Lever in

Multi-Purpose Foot - Attaching Pre-Strung Beads

Fabric mediumweight, 4" x 8"
Other 10" length of 4mm, plastic, pre-strung beads
Needle 80/12 Universal
Thread 3 cones serger thread
Presser Foot Multi-Purpose Foot with Guide
Stitch narrow 3-thread flatlock (right needle)

Following the instructions in your owner's manual, thread the serger for a narrow 3-thread flatlock stitch using the right needle. Adjust settings as indicated.

Set stitch length to 4mm.

Attach the Multi-Purpose Foot (no guide), following the directions in the instruction leaflet for the Multi-Purpose Foot with Guide.

Lay the pre-strung beads in the groove on the top of the foot, threading them under the back groove (see instruction leaflet for the Multi-Purpose Foot with Guide). Turn the handwheel to encase the first beads inside the thread chain.

Fold the fabric in half to 2" x 6" and place the fabric under the foot with the fold halfway between the needle and the stitch finger or against the right seam guide.

Slowly flatlock the beads to the folded fabric.

Gently pull the fabric flat.

Mount the sample.

Notes

Multi-Purpose Foot - Attaching Pre-Strung Beads Sample

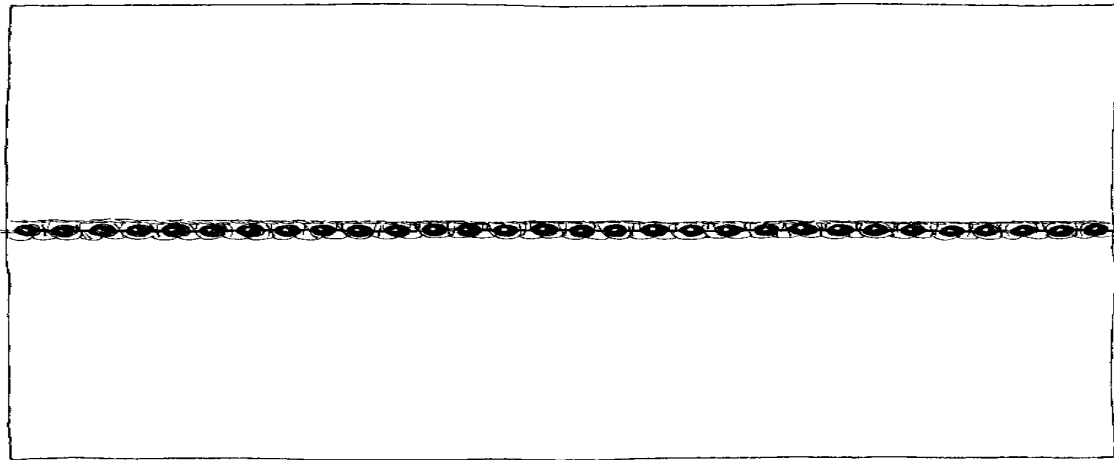

3-Thread Flatlock - Narrow

Upper Looper	3-5	Cutting Width	2-3
Lower Looper	7-9	Stitch Length	4mm
Left Needle	n/a	Differential Feed	N
Right Needle	1-2	Rolled Edge Lever	in

Class 4

Miscellaneous Techniques

Product Reference List

- Feet-ures, Unit M
- Serger Technique Reference Book*
- Sergering Made Easy!*

- Multi-Purpose Foot with Guide
- Elasticator
- Right Seam Guide
- Attachment Base (700D and 800DL only)
- 2-Thread Adapter (700D only)

- Pearls-by-the-Yard (3mm-4mm)
- Seam Sealant
- Wavy Cutting Blade
- Clear Quilters' Ruler
- Cutting Mat
- BERNINA® Ironing System
- Large Eye Tapestry/Darning Needles
- Vacuum Cleaner Attachment
- 1" Wide Cosmetic Brush or Mini-Duster
- Carrying Case
- BERNINA® Thread Storage Box (clear)
- BERNINA® Deluxe Accessory Box
- Scrap catcher
- Serger Needle/Looper Threader
- 6" Ruler/Gauge

- Stretch Needles size _____
- Ballpoint Needles size _____
- Sharp Needles size _____
- Microtex Needles size _____
- Stretch Needles size _____
- Universal Needles size _____

- Serger thread (Mettler Metrocor, YLI Elite)
 - color _____
 - color _____

- Woolly Nylon texturized thread
 - color _____
 - variegated _____

- Isacord embroidery thread
 - color _____
 - color _____

- YLI Jeans Stitch thread
 - color _____
 - variegated _____

- YLI Pearl Crown Rayon
 - color _____
 - variegated _____

- YLI Designer 6
 - color _____
 - color _____

- YLI Candlelight
 - color _____
 - color _____

Class 5

Cover & Chain

Class Overview

Conversion to Cover/Chain Stitch (1300DC & 2500DCET only)

Coverstitch Techniques

- 1 Coverstitch
- 2 Top & Bottom Coverstitch (2500DCET only)
- 3 Mock Flat Felled Seam
- 4 Coverstitch Hem - Woven Fabric
- 5 Coverstitch Hem - Knit Fabric
- 6 Attaching Lace

Chain Stitch Techniques

- 7 Chain Stitch Seam
- 8 Attaching Binding
- 9 Decorative Chain Stitch
- 10 4-Thread Combination Stitch (1300DC only)
- 11 5-Thread Combination Stitch (1300DC only)

Optional Presser Feet & Accessories (used in this unit)

Coverstitch Foot

Two “floating” toes for ease in stitching uneven layers

This class is formatted for owners of the following models of BERNINA® overlock machines:

- 1300DC
- 2500DCET
- 009DCC

Coverstitch

Fabric firm fabric, 3" x 6"
Needle 80/12 Universal
Thread 3 cones serger thread
Presser Foot standard or Coverstitch
Stitch wide 3-thread coverstitch

Following the instructions in your owner's manual, thread the serger for cover stitch using thread colors to match the color-coded threading path on the serger (use blue thread for purple markings).

Center the fabric under the presser foot. Lift the presser foot and place the fabric completely under the foot.

Turn the handwheel clockwise for the first stitch.

Serge to the end of the fabric.

At the end of the stitching, turn the handwheel counterclockwise until the needles are at their lowest position. Then turn the handwheel clockwise until the needles are at their highest position to release the threads from the looper.

Raise the presser foot and carefully remove the work.

Cut the thread using the thread cutter.

Examine the serger stitch formation and compare it to the stitch graphic in your owner's manual. Read the tension adjustment information in your owner's manual for information about stitch formation and irregularities. Adjust settings as necessary; stitch a second row of coverstitch.

Trim and mount the sample.

Notes

Coverstitch Sample

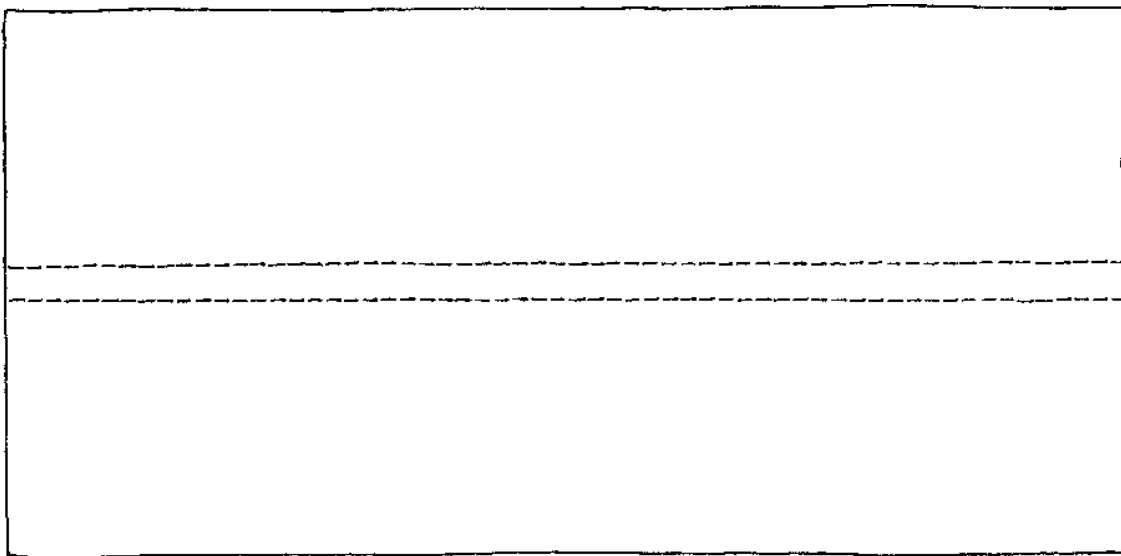

Two Needle Coverstitch - Wide

009DCC		1300DC		2500DECT
Left Needle 33-5		Left Needle 3.2		Needles Left, Right
Right Needle 3-5		Right Needle 6.5		Tension F
Looper M		Chain Looper M		
Stitch Length 3mm		Stitch Length 3.0mm		Stitch Length 3mm

Top & Bottom Coverstitch (2500DCET only)

Fabric firm fabric, 6" x 6"
Needle 80/12 Universal
Thread 3 cones serger thread
..... 2 cones YLI Jeans Stitch
Presser Foot standard or Coverstitch
Stitch wide 5-thread coverstitch (2500DCET only)

Following the instructions in your owner's manual, thread the serger for top and bottom cover stitch using Jeans Stitch in the looper and wiper.

Fold up a 2" hem along one 6" edge. Position the fabric right side up under the presser foot so that the needles will pierce the top edge of the hem. Serge the hem in place.

At the end of the stitching, turn the handwheel counterclockwise until the needles are at their lowest position. Then turn the handwheel clockwise until the needles are at their highest position to release the threads from the looper.

Raise the presser foot and carefully remove the work.

Cut the thread using the thread cutter.

Examine the serger stitch formation and compare it to the stitch graphic in your owner's manual. Read the tension adjustment information in your owner's manual for information about stitch formation and irregularities. Adjust settings as necessary; stitch a second row of coverstitch.

Trim and mount the sample.

Notes

Top & Bottom Coverstitch Sample

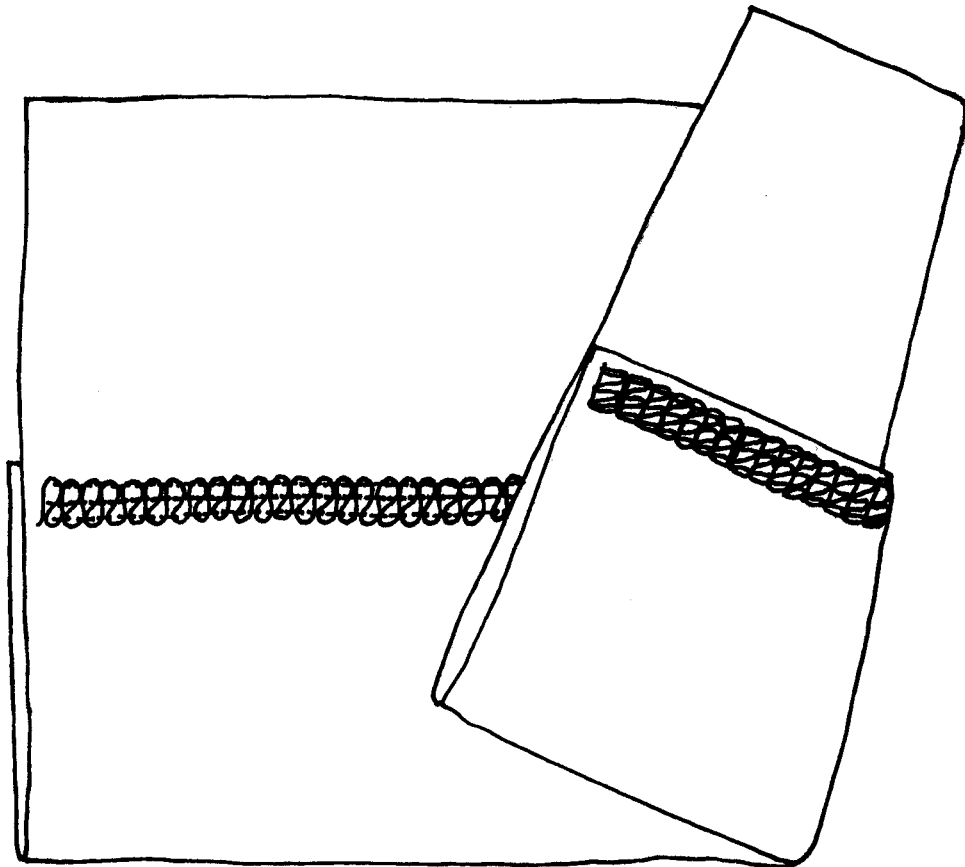

Top & Bottom Coverstitch - 3 needles

2500DCET

Needles Left, Center, Right

Tension H

Stitch Length 3mm

Mock Flat Felled Seam

Fabric mediumweight cotton twill, 4" x 6"
Needle 80/12 Universal
Thread 3 cones serger thread
Presser Foot Coverstitch
Stitch wide 3-thread coverstitch

Following the instructions in your owner's manual, thread the serger for cover stitch using thread colors to match the color-coded threading path on the serger (use blue for purple markings).

Fold the fabric to form a ½" tuck lengthwise through the center of the fabric.

Center the fabric under the presser foot. Lift the presser foot and place the fabric completely under the foot, with the bulk of the fold to the left. Align the folded edge with the inside of the right floating toe of the presser foot.

Coverstitch, forming a tuck along the edge of the fabric. Serge to the end of the fabric.

At the end of the stitching, turn the handwheel counterclockwise until the needles are at their lowest position. Then turn the handwheel clockwise until the needles are at their highest position to release the threads from the looper.

Raise the presser foot and carefully remove the work. Cut the thread using the thread cutter.

Trim and mount the sample.

Notes

Mock Flat Felled Seam Sample

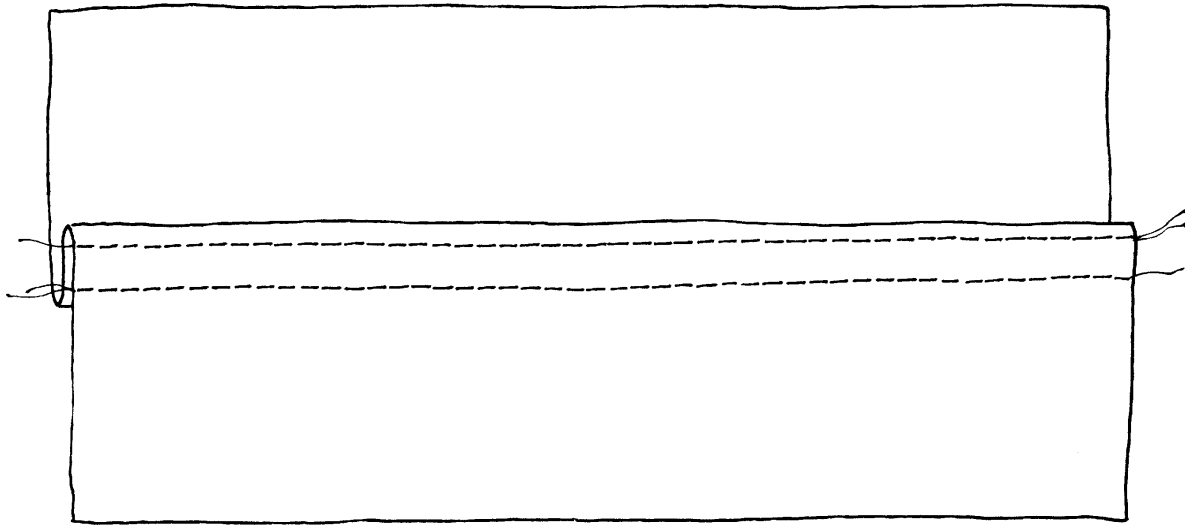

Two Needle Coverstitch - Wide

009DCC		1300DC		2500DECT
Left Needle 33-5		Left Needle 3.2		Needles Left, Right
Right Needle 3-5		Right Needle 6.5		Tension F
Looper M		Chain Looper M		
Stitch Length 3mm		Stitch Length 3mm		Stitch Length 3mm

Coverstitch Hem - Woven Fabric

Fabric mediumweight cotton twill, 4" x 6"
Needle 80/12 Universal
Thread 3 cones serger thread
Presser Foot Coverstitch
Stitch wide 3-thread coverstitch

Notes

Following the instructions in your owner's manual, thread the serger for cover stitch using thread colors to match the color-coded threading path on the serger (use blue for purple markings).

Fold up a 2" hem along the 6" edge of the fabric. Glue stick or pin in place.

Using the markings on the stitch plate as a guide, place the fabric under the needles with the fold to the right of the presser foot, with the right side of the fabric up and the hem/wrong side down.

Coverstitch the hem in place.

Trim and mount the sample.

Coverstitch Hem Sample - Woven Fabric

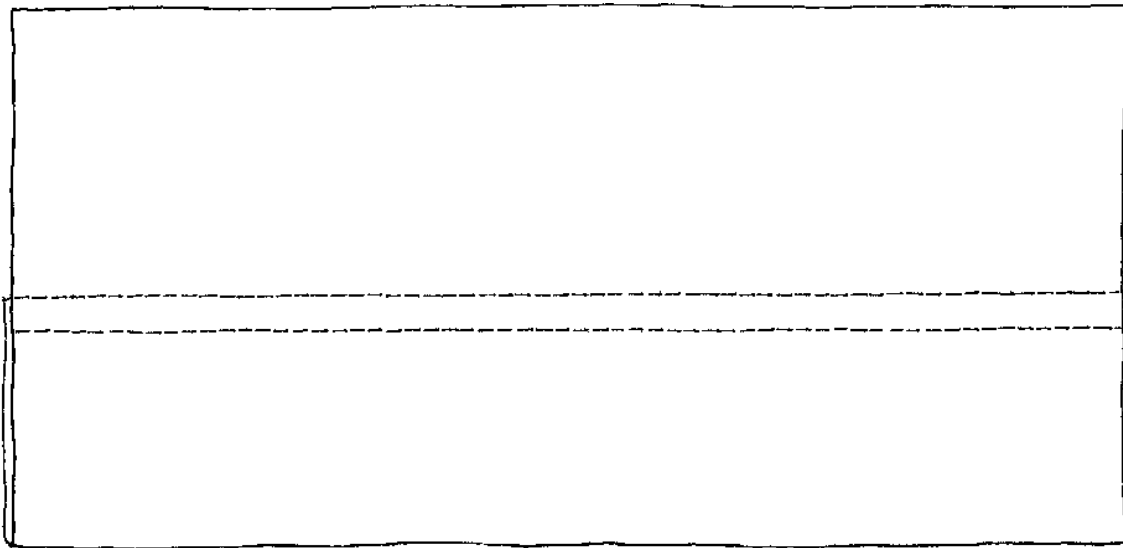

Two Needle Coverstitch - Wide

009DCC	1300DC	2500DECT
Left Needle 33-5	Left Needle 3.2	Needles Left, Right
Right Needle 3-5	Right Needle 6.5	Tension F
Looper M	Chain Looper M	
Stitch Length 3mm	Stitch Length 3mm	Stitch Length 3mm

Coverstitch Hem - Knit Fabric

Fabric cotton jersey, 5" x 6"
Needle 80/12 Universal
Thread 3 cones serger thread
Presser Foot Coverstitch
Stitch wide 3-thread coverstitch

Notes

Following the instructions in your owner's manual, thread the serger for cover stitch using thread colors to match the color-coded threading path on the serger (use blue for purple markings).

Fold up a 2" hem along the 6" edge of the fabric. Glue stick or pin in place.

Using the markings on the stitch plate as a guide, place the fabric under the needles with the fold to the right or the presser foot, with the right side of the fabric up and the hem/wrong side down.

Coverstitch the hem in place. There is no need to stretch the fabric while stitching, as the cover stitch has natural stretch.

Trim and mount the sample.

Coverstitch Hem Sample - Knit Fabric

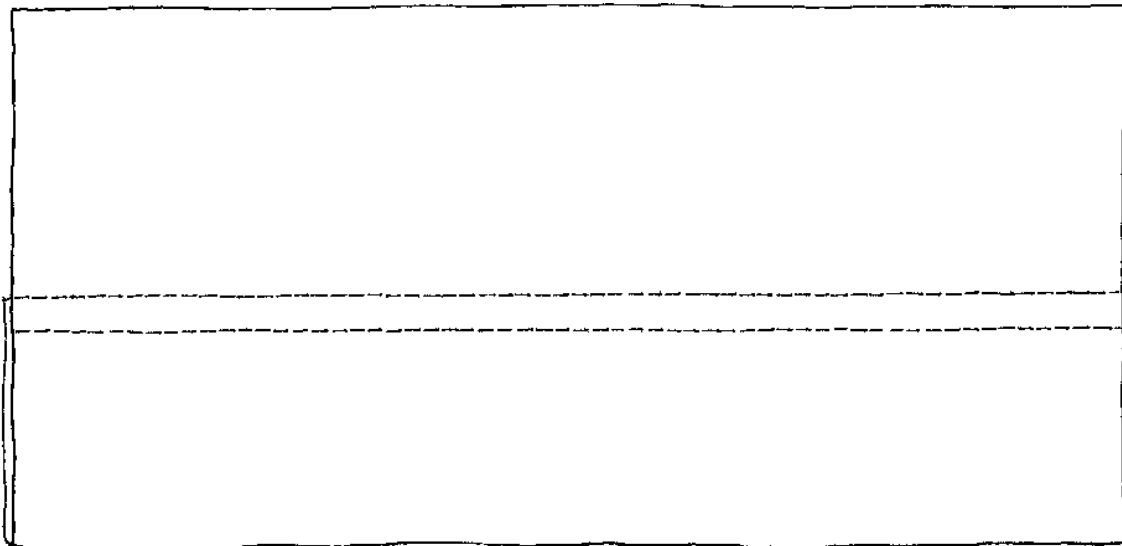

Two Needle Coverstitch - Wide

009DCC		1300DC		2500DECT
Left Needle 33-5		Left Needle 3.2		Needles Left, Right
Right Needle 3-5		Right Needle 6.5		Tension F
Looper M		Chain Looper M		
Stitch Length 3mm		Stitch Length 3mm		Stitch Length 3mm

Attaching Lace

Fabric mediumweight cotton, 3" x 6"
..... 8" length of 1" wide lace edging
Needle 80/12 Universal
Thread 3 cones serger thread
Presser Foot Coverstitch
Stitch wide 3-thread coverstitch

Use spray starch or fabric stiffener to stabilize the fabric and lace.

Position the lace on the right side of the fabric with the scalloped edge of the lace even with the left side of the fabric.

Place fabric and lace under the needles with the lace header positioned even with the inside edge of the right floating toe.

Coverstitch the lace to the fabric.

Trim fabric from beneath the lace.

Trim and mount sample.

Notes

Attaching Lace Sample

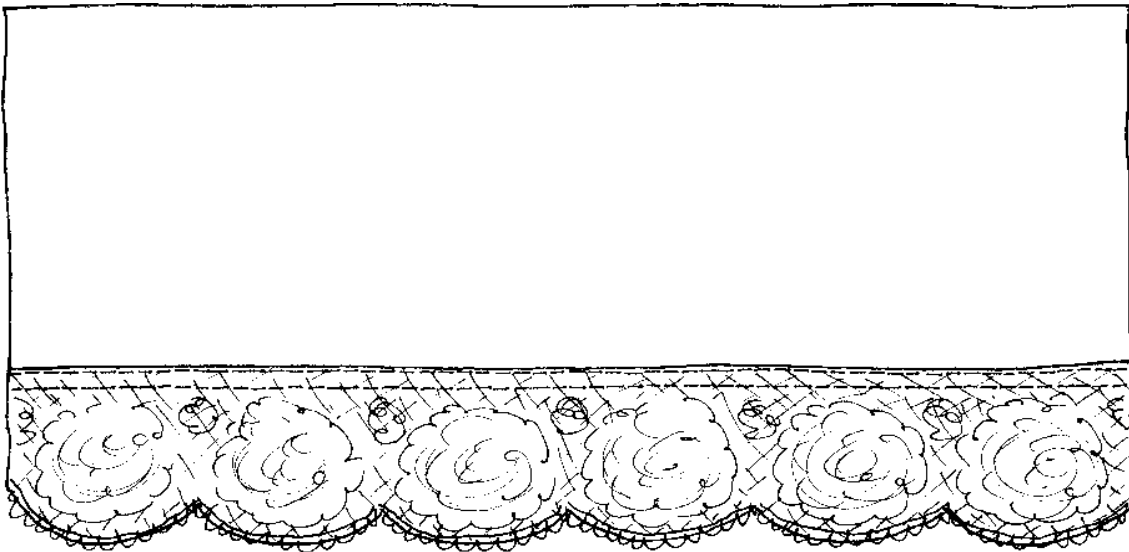

Two Needle Coverstitch - Wide

009DCC		1300DC		2500DECT
Left Needle 3-5		Left Needle 3.2		Needles Center, Right
Right Needle 3-5		Center Needle 5.5		Tension F
Looper M		Chain Looper M		
Stitch Length 3mm		Stitch Length 3mm		Stitch Length 3mm

Chain Stitch Seam

Fabric 2 pieces mediumweight cotton, each 3" x 6"
Needle 80/12 Universal
Thread 2 cones serger thread
Presser Foot Coverstitch
Stitch wide 3-thread coverstitch

Following the instructions in your owner's manual, thread the serger for chain stitch using thread colors to match the color-coded threading path on the serger (use blue thread for purple markings).

With right sides together, place the fabric under the needles. Align the raw edges with the $\frac{5}{8}$ " mark on the stitch plate.

Turn the handwheel clockwise for the first stitch.

Serge to the end of the fabric.

At the end of the stitching, turn the handwheel counterclockwise until the needle is at its lowest position. Then turn the handwheel clockwise until the needle is at its highest position to release the thread from the looper.

Following the instructions in your owner's manual, raise the presser foot and carefully remove the work. Cut the thread using the thread cutter.

Examine the serger stitch formation and compare it to the stitch graphic in your owner's manual. Read the tension adjustment information in your owner's manual for information about the stitch formation and correcting any stitch irregularities. Make any necessary tension adjustments and serge another row of stitching.

Trim and mount the sample.

Notes

Chain Stitch Seam Sample

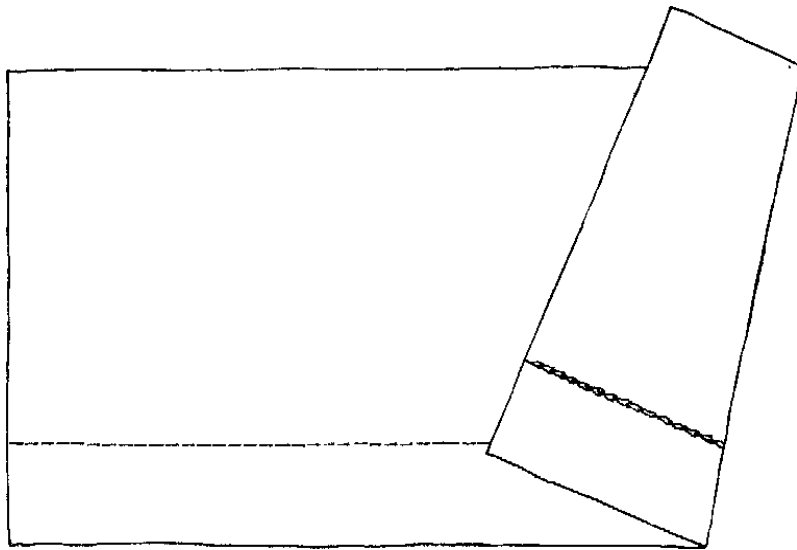

Chain Stitch

009DCC	1300DC	2500DECT
Left Needle 3-5	Left Needle 4.5	Needles Right
Right Needle n/a	Right Needle n/a	Tension G
Looper M	Chain Looper M	
Stitch Length 2.5mm	Stitch Length 2.5mm	Stitch Length 2.5mm

Attaching Binding

Fabric pre-quilted fabric, 3" x 6"
..... 20" length of wide prefolded bias binding
Needle 80/12 Universal
Thread 2 or 3 cones serger thread
Presser Foot standard or Coverstitch
Stitch chainstitch or coverstitch

Cover Stitch Option:

Following the instructions in your owner's manual, thread the serger for cover stitch.

Wrap the bias binding around one 6" side of the quilted fabric; secure in place with 505 temporary spray adhesive.

Place the fabric under the needles with the unstitched edge of the binding even with the inside of the **left** floating toe, with the quilted fabric to the **left**.

Coverstitch the binding to the quilted fabric.

Chain Stitch Option:

Following the instructions in your owner's manual, thread the serger for chain stitch.

Wrap the bias binding around one 6" side of the quilted fabric; secure in place with 505 temporary spray adhesive.

Place the fabric under the needles with the unstitched edge of the binding even with the inside of the **left** floating toe, with the quilted fabric to the **right**.

Chain stitch the binding to the quilted fabric.

Trim and mount the sample.

Notes

Attaching Binding Sample

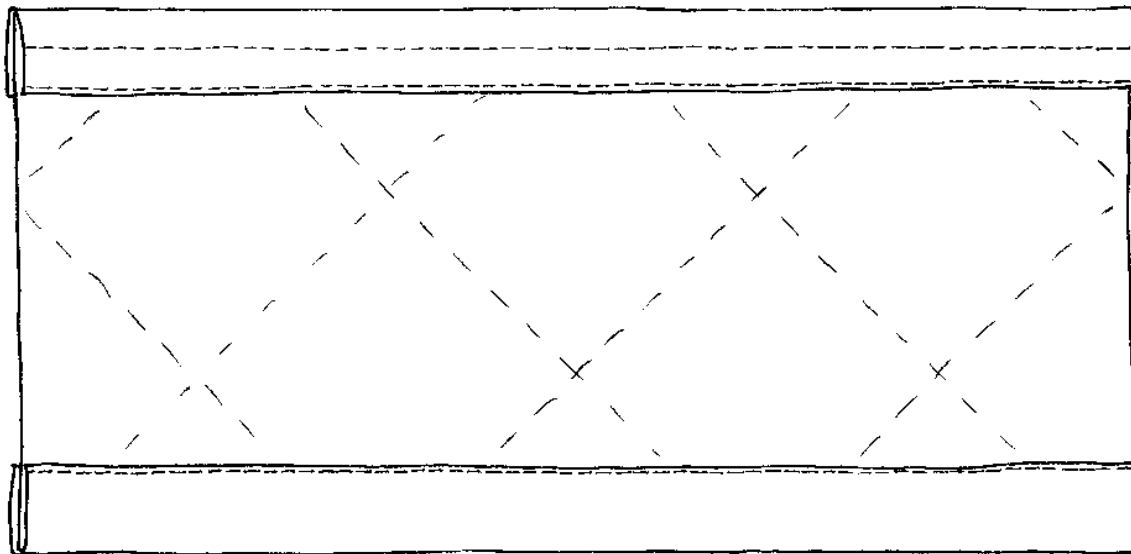

Chain Stitch

009DCC	1300DC	2500DECT
Left Needle 3-5	Left Needle 4.5	Needles Right
Right Needle n/a	Right Needle n/a	Tension G
Looper M	Chain Looper M	
Stitch Length 2.5mm	Stitch Length 2.5mm	Stitch Length 2.5mm

Two Needle Coverstitch - Wide

009DCC	1300DC	2500DECT
Left Needle 33-5	Left Needle 3.2	Needles Left, Right
Right Needle 3-5	Right Needle 6.5	Tension F
Looper M	Chain Looper M	
Stitch Length 3mm	Stitch Length 3mm	Stitch Length 3mm

Decorative Chain Stitch

Fabric	mediumweight denim, 6" x 6"
Stabilizer	tear-away, 6" x 6"
Needle	80/12 Universal
Thread	1 cone serger thread
.....	3 cones Isacord embroidery thread
.....	1 cone Yenmet metallic thread
Presser Foot	standard or Coverstitch
Stitch	chainstitch

Notes

Following the instructions in your owner's manual, thread the serger for cover stitch, threading the 3 strands of Isacord embroidery thread together, treating them as one thread. Use a lower looper threader or dental floss threader to thread them through the eye of the looper.

Slightly loosen the tension on the chain stitch looper.

Place the stabilizer against the **wrong side** of the denim. Place the denim **right side down** under the presser foot; the stabilizer will be on top.

Chainstitch a curved line across the fabric. Turn the fabric over to see the decorative stitching on the right side.

To increase the amount of decorative thread that shows, increase the stitch length to 3mm or 4mm. Changing stitch length as you serge will vary the decorative chain stitch effect. Always use a stitch length of at least 2.5mm.

Stitch several more curved lines across the fabric.

Remove one spool of Isacord embroidery thread and replace it with Yenmet metallic thread. Rethread the serger using 2 spools of Isacord embroidery thread and 1 spool of Yenmet metallic thread in the lower looper. Loosen the chain stitch looper tension slightly. Sew several additional rows of decorative chain stitch.

Trim and mount the sample.

Decorative Chain Stitch Sample

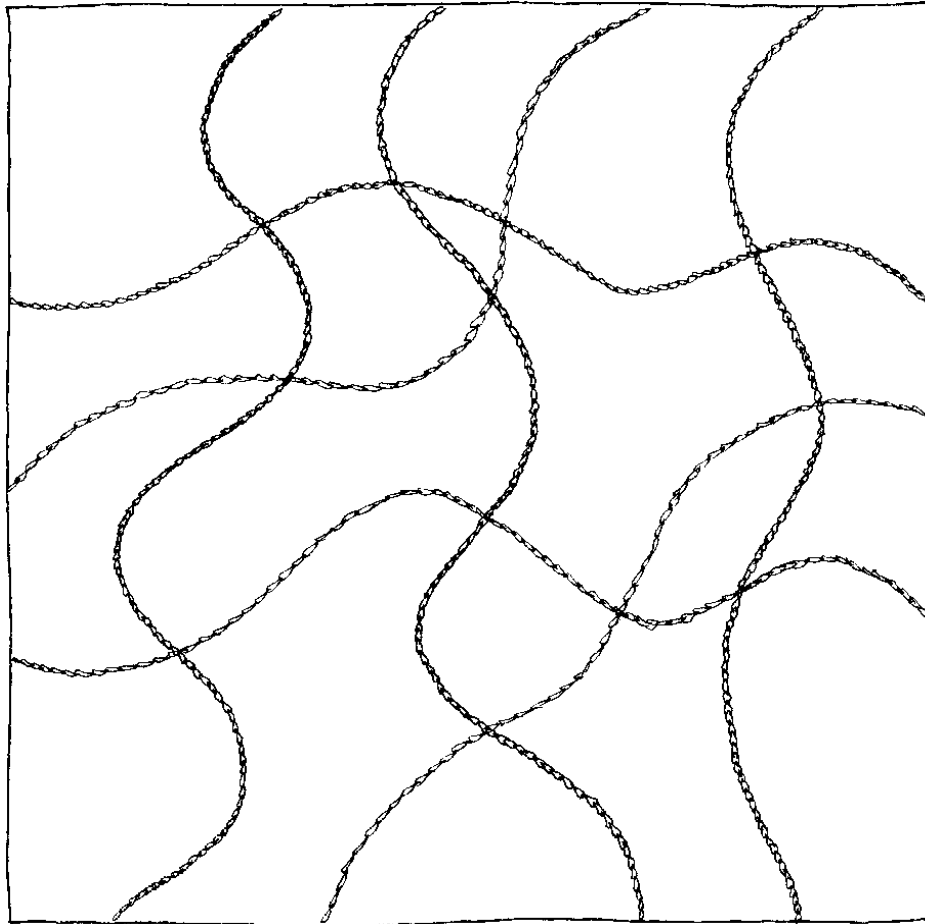

Chain Stitch

009DCC		1300DC		2500DECT
Left Needle 3-5		Left Needle 4.5		Needle Right
Right Needle n/a		Right Needle n/a		Tension G
Looper M		Chain Looper M		
Stitch Length 2.5mm		Stitch Length 2.5mm		Stitch Length 2.5mm



4-Thread Combination Stitch (1300DC only)

Fabric 2 pieces mediumweight cotton, 3" x 8"
Needle 80/12 Universal
Thread 4 cones serger thread
Presser Foot standard
Stitch 2-thread overlock with chain stitch (#19)

Thread the serger for a 4-thread combination stitch, following the instructions on the LCD screen (which are also in your owners manual).

Serge fabric strips together along one long edge.

Trim and mount the sample.

Notes

4-Thread Combination Stitch Sample

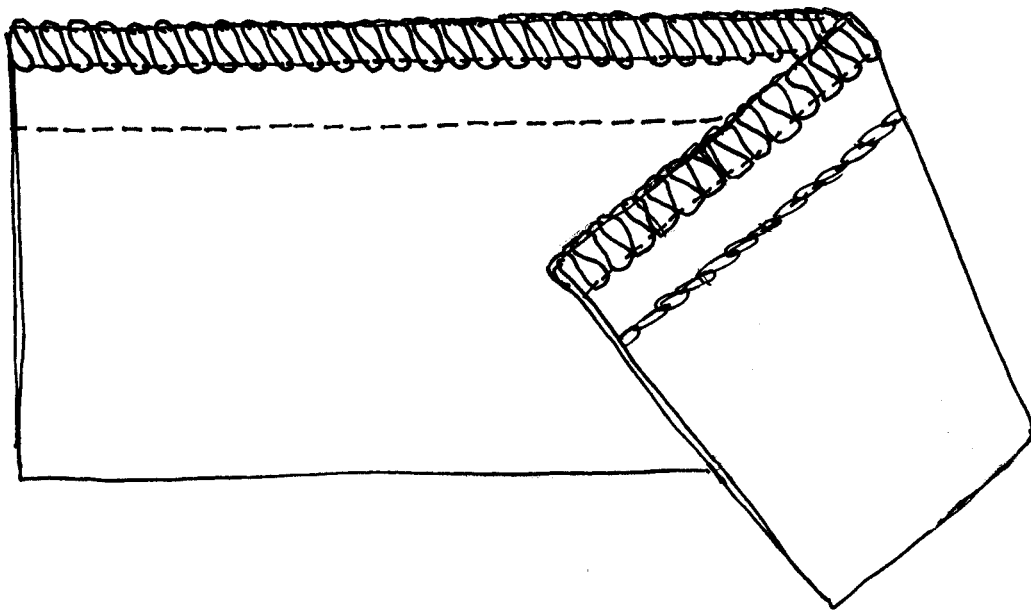

4-Thread Combination Stitch (1300DC only)

1300DC

Right Coverstitch Needle 3.2

Left Overlock Needle 4

Chain Looper M

Upper Looper converter

Lower Looper 6.7

Stitch Length 2.5mm



5-Thread Combination Stitch (1300DC only)

Fabric 2 pieces mediumweight cotton, 3" x 8"
Needle 80/12 Universal
Thread 5 cones serger thread
Presser Foot standard
Stitch 3-thread overlock with chain stitch (#18)

Thread the serger for a 5-thread combination stitch, following the instructions on the LCD screen (which are also in your owners manual).

Serge fabric strips together along one long edge.

Trim and mount the sample.

Notes

5-Thread Combination Stitch Sample

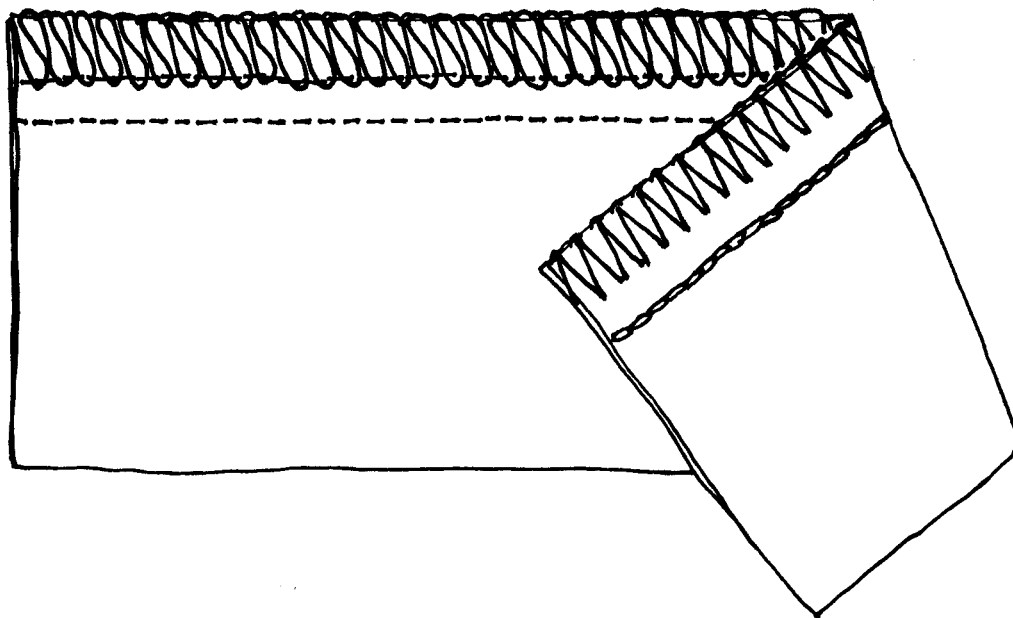

5-Thread Combination Stitch (1300DC only)

1300DC	
Right Coverstitch Needle	4.0
Right Overlock Needle	4.5
Chain Looper	M
Upper Looper	4.0
Lower Looper	4.0
Stitch Length	2.5mm

Class 5 Cover & Chain Product Reference List

- Features - Unit M*
- Serger Technique Reference Book*
- Serging Made Easy!*

- Mettler serger thread
 - color _____
 - color _____
 - color _____

- Isacord embroidery thread
 - color _____
 - color _____
 - color _____

- Yenmet metallic thread
 - color _____
 - color _____

- 505 temporary adhesive spray
- Bias binding
- Bias tape makers
- BERNINA® Ironing System
- 6" seam guide
- Rotary cutter
- BERNINA® cutting mat
- BERNINA® clear 14" ruler