



# **BiPAC 7820NZ**

**3G/4G LTE Embedded with Dual-SIM  
Slots ADSL2+ Wireless-N VPN Firewall  
Router**

## **User Manual**

# Table of Contents

<i>Chapter 1: Introduction</i> .....	1
Introduction to your Router.....	1
Features.....	3
ADSL Compliance.....	3
Network Protocols and Features.....	4
3G/4G LTE .....	4
Firewall .....	4
Quality of Service Control.....	5
ATM, PTM and PPP Protocols.....	5
IPTV Applications .....	5
Wireless LAN.....	5
USB Application Server.....	6
Virtual Private Network (VPN).....	6
Management .....	6
Hardware Specifications .....	7
Physical Interface.....	7
<i>Chapter 2: Installing the Router</i> .....	8
Package Contents.....	8
Important note for using this router.....	9
Device Description .....	10
The Front LEDs.....	10
The Rear Ports .....	11
Cabling.....	12
<i>Chapter 3: Basic Installation</i> .....	13
Connecting Your Router.....	14
Network Configuration .....	16
Configuring a PC in Windows 7/8.....	16
Configuring a PC in Windows Vista.....	19
Configuring a PC in Windows XP .....	22
Factory Default Settings.....	24
Information from your ISP .....	26
<i>Easy Sign On (EZSO)</i> .....	27
<i>Chapter 4: Configuration</i> .....	34
Configuration via Web Interface.....	34
Status.....	36
Summary.....	37
WAN.....	38
Statistics.....	39
LAN .....	39

WAN Service.....	40
xTM.....	40
xDSL.....	41
Bandwidth Usage.....	44
LAN.....	44
WAN Service.....	46
3G/LTE Status .....	48
Route .....	49
ARP.....	50
DHCP .....	51
VPN .....	52
IPSec.....	52
PPTP.....	53
L2TP .....	54
OpenVPN.....	55
GRE.....	56
Log .....	57
System Log .....	57
Security Log.....	58
VRRP Status .....	59
Quick Start.....	60
Quick Start .....	60
Configuration .....	67
LAN - Local Area Network.....	68
Ethernet .....	68
IPv6 Autoconfig.....	71
Interface Grouping.....	75
LAN VLAN Setting.....	78
Eth Port Control .....	79
VRRP .....	80
Wireless .....	81
Basic .....	82
Security.....	84
MAC Filter .....	96
Wireless Bridge .....	97
Advanced.....	99
Station Info.....	101
Schedule Control.....	102
WAN-Wide Area Network .....	103
WAN Service.....	103
Failover.....	126
Dual SIM .....	127
DSL.....	128
SNR .....	130
System .....	131
Internet Time .....	131
Firmware Upgrade .....	132
Backup / Update.....	133
Access Control.....	134
Mail Alert.....	135
SMS Alert.....	136
Configure Log .....	137

USB.....	138
Storage Device Info .....	138
User Account.....	139
Print Server.....	146
DLNA.....	151
IP Tunnel .....	153
IPv6inIPv4.....	153
IPv4inIPv6.....	155
Security .....	156
IP Filtering Outgoing .....	156
IP Filtering Incoming .....	159
MAC Filtering.....	161
Blocking WAN PING.....	162
Time Restriction .....	163
URL Filter .....	165
Parental Control Provider .....	168
QoS - Quality of Service .....	169
QoS Port Shaping .....	174
NAT .....	175
Exceptional Rule Group.....	175
Virtual Servers.....	177
DMZ Host.....	181
One-to-One NAT.....	182
Port Triggering.....	183
ALG .....	186
Wake On LAN.....	187
VPN.....	189
IPSec.....	189
VPN Account .....	199
Exceptional Rule Group .....	200
PPTP .....	202
PPTP Server .....	202
PPTP Client .....	203
L2TP .....	214
L2TP Server.....	214
L2TP Client.....	216
OpenVPN .....	230
OpenVPN Server.....	230
OpenVPN CA.....	232
OpenVPN Client.....	233
GRE.....	240
Advanced Setup .....	241
Routing.....	242
Default Gateway .....	242
Static Route .....	243
Policy Routing.....	245
RIP .....	246
DNS .....	247
DNS.....	247
Dynamic DNS.....	249
DNS Proxy.....	252
Static DNS.....	253

Static ARP.....	254
UPnP .....	255
Certificate .....	262
Trusted CA.....	262
Multicast.....	265
Management .....	267
SNMP Agent .....	267
TR- 069 Client .....	268
HTTP Port .....	270
Remote Access .....	271
Mobile Network .....	272
3G/LTE Usage Allowance .....	273
Power Management .....	274
Time Schedule .....	275
Auto Reboot .....	276
Diagnostics.....	277
Diagnostics Tools.....	277
Push Service .....	280
Diagnostics .....	281
Fault Management.....	282
Restart.....	283
<i>Chapter 5: Troubleshooting.....</i>	<i>284</i>
<i>Appendix: Product Support &amp; Contact.....</i>	<i>286</i>

# Chapter 1: Introduction

## Introduction to your Router

The BiPAC 7820NZ, triple-WAN 3G/LTE/ADSL2+ firewall router is integrated with the 802.11n Wireless Access Point and 4-port switch. It is a cutting-edge networking product for SOHO and office users. Uniquely, the router allows users to directly insert 3G/4G LTE SIM card into its built-in SIM slots instead of requiring external USB modems. This design will avoid compatibility issues of many different 3G/LTE USB modems. With the increasing popularity of the 3G/4G LTE standard, communication via the BiPAC 7820NZ is becoming more convenient and widely available - enabling users to use a 3G/4G LTE, UMTS, EDGE, GPRS, or GSM Internet connection, making downstream rates of up to 100Mbps possible. Users can watch movies, download music or access e-mail wherever a 3G/4G LTE connection is available.

### **3G/4G LTE Mobility and Always-on Connectivity**

The BiPAC 7820NZ router allows you to insert 3G/4G LTE SIM card to its built-in SIM slots, enabling you to use a 3G/4G LTE Internet connection, which makes downstream rates of up to 100Mbps<sup>3</sup> possible. With the increasing popularity of the 3G/4G LTE standard, communication via the BiPAC 7820NZ is becoming more convenient and widely available - allowing you to watch movies, download music on the road, or access e-mail no matter where you are. You can even share your Internet connection with others, no matter if you're in a meeting, or speeding across the country on a train. The auto fail-over feature ensures optimum connectivity and minimum interruption by quickly and smoothly connecting to a 3G/4G LTE network in the event that you ADSL/Fibre/Cable line fails. The BiPAC 7820NZ will then automatically reconnect to the ADSL/Fibre/Cable connection when it is restored, reducing connection costs. These features are perfect for office situations when a constant and smooth WAN connection is critical.

### **Optimal wireless performance**

With an integrated 802.11n Wireless Access Point, the router delivers up to 6 times the speed of an 802.11a/b/g network device. It supports a data rate of up to 300Mbps and is also compatible with 802.11a/b/g equipment. The Wireless Protected Access (WPA-PSK/WPA2-PSK) and Wireless Encryption Protocol (WEP) features enhance the level of transmission security and access control over wireless LAN. The router also supports the Wi-Fi Protected Setup (WPS) standard, allowing users to establish a secure wireless network by simply pushing a button. If your network requires wider coverage, the built-in Wireless Distribution System (WDS) repeater function allows you to expand your wireless network without the need for any external wires or cables.

### **Secure VPN Connections**

The BiPAC 7820NZ supports all currently popular secure VPNs, including embedded IPSec VPN, PPTP, L2TP, OpenVPN, GRE, which satisfies different users' needs, allowing users to establish encrypted private connections over the Internet with your optimum VPN options. You can access your corporate Intranet and transmit sensitive data between branch offices and remote sites anytime; even when you are out of office, thus enhancing productivity.

## **Smooth, Responsive Net Connection**

Quality of Service (QoS) gives user full control over outgoing data traffic. Priority can be assigned by the router to ensure that important transmissions like gaming packets, or IPTV/streaming content passes through the router at lightning speed, even when there is heavy Internet traffic. The speed of different types of outgoing data passing through the router is also controlled to ensure that users do not saturate bandwidth with their browsing activities.

## **IPv6 supported**

Internet Protocol version 6 (IPv6) is a version of the Internet Protocol that is designed to succeed IPv4. IPv6 has a vastly larger address space than IPv4. This results from the use of a 128-bit address, whereas IPv4 uses only 32 bits. The new address space thus supports  $2^{128}$  (about  $3.4 \times 10^{38}$ ) addresses. This expansion provides flexibility in allocating addresses and routing traffic and eliminates the primary need for network address translation (NAT), which gained widespread deployment as an effort to alleviate IPv4 address exhaustion.

The BiPAC 7820NZ fully supports IPv6 (Internet Protocol Version 6), launched as the current IPv4 range is filling up, and IPv6 is gradually becoming the indispensable addressing system for savvy cloud computing users. Dual stack means the router is capable of running IPv4 and IPv6 in parallel during the transition period. With Billion IPv6 enabled devices, three major transition mechanisms such as Dual-Stack, Dual-Stack Lite, and 6RD (IPv6 rapid deployment) are supported to be adapted easily into service provider's IPv4/IPv6 network

## **Virtual AP**

A "Virtual Access Point" is a logical entity that exists within a physical Access Point (AP). When a single physical AP supports multiple "Virtual APs", each Virtual AP appears to stations (STAs) to be an independent physical AP, even though only a single physical AP is present. For example, multiple Virtual APs might exist within a single physical AP, each advertising a distinct SSID and capability set. Alternatively, multiple Virtual APs might advertise the same SSID but a different capability set – allowing access to be provided via Web Portal, WEP, and WPA simultaneously. Where APs are shared by multiple providers, Virtual APs provide each provider with separate authentication and accounting data for their users, as well as diagnostic information, without sharing sensitive management traffic or data between providers. You can enable the virtual AP.

## **Web Based GUI**

It supports web based GUI for configuration and management. It is user-friendly and comes with online help. It also supports remote management capability for remote users to configure and manage this product.

## **Firmware Upgradeable**

Device can be upgraded to the latest firmware through the WEB based GUI.

# Features

- IPv6 ready (IPv4/IPv6 dual stack)
- Triple-WAN ports for 3G/4G LTE, ADSL2+, Ethernet WAN (EWAN) for broadband connectivity
- 3G/4G LTE embedded with dual SIM card slots
- High-speed Internet Access via ADSL2 / 2+; Backward Compatible with ADSL
- Ethernet port #4 can be configured as a WAN interface for broadband connectivity
- Auto fail-over to ensure an always-on WAN connection
- IEEE 802.11 b/g/n compliant Wireless Access Point with Wi-Fi Protected Setup (WPS)
- Wi-Fi Protected Access (WPA-PSK/ WPA2-PSK) and Wired Equivalent Privacy (WEP) support
- Secured 16 IPSec VPN tunnels with powerful DES/ 3DES/ AES
- PPTP VPN with Pap/ Chap/ MS-CHAPv2 authentication
- Pure L2TP and L2TP over IPSec
- OpenVPN with CA authentication and extensive OpenSSL encryption
- GRE tunnel
- SOHO Firewall Security with DoS Preventing and Packet Filtering
- Quality of Service Control for traffic prioritization and Bandwidth management
- Universal Plug and Play (UPnP) Compliance
- Supports IPTV Application<sup>\*2</sup>
- USB port for print server, NAS(Samba), FTP server DLNA media server
- Ease of Use with Quick Installation Wizard (EZSO)

## ADSL Compliance

- Compliant with ADSL Standard
  - Full-rate ANSI T1.413 Issue 2
  - G.dmt (ITU G.992.1)
  - G.lite (ITU G.992.2)
  - G.hs (ITU G.994.1)
- Compliant with ADSL2 Standard
  - G.dmt.bis (ITU G.992.3)
  - ADSL2 Annex M (ITU G.992.3 Annex M)
- Compliant with ADSL2+ Standard
  - G.dmt.bis plus (ITU G.992.5)
  - ADSL2+ Annex M (ITU G.992.5 Annex M)



## Network Protocols and Features

- IPv4 or IPv4 / IPv6 Dual Stack
- NAT, static (v4/v6) routing and RIP-1 / 2
- IPv6 Stateless / Stateful Address Auto-configuration
- IPv6 Router Advertisement
- IPv6 over PPP
- DHCPv6
- IP Tunnel IPv6 in IPv4(6RD)
- IP Tunnel IPv4 in IPv6(DS-Lite)
- Universal Plug and Play (UPnP) Compliant
- Dynamic Domain Name System (DDNS)
- Virtual Server, DMZ
- SNTP, DNS relay, IGMP snooping and IGMP proxy for video service
- MLD snooping and MLD proxy for video service
- Management based-on IP protocol, port number and address
- SMTP client with SSL/TLS
- Supports port-based and tag-based Interface Grouping (VLAN)

## 3G/4G LTE <sup>\*3</sup>

- LTE: peak downlink speed of up to 100Mbps and peak uplink speed of up to 50Mbps
  - Supports multi-band LTE: 2100MHz (B1), 1800MHz (B3), 2600MHz (B7), 900MHz (B8), 800MHz (B20).
  - Supports multi-band WCDMA: 2100MHz (B1), 1900MHz (B2), 850MHz (B5), 900MHz (B8)
- 3G/HSPA+: peak downlink speed of up to 14.4Mbps and peak uplink speed of up to 5.76Mbps
  - Supports dual-band WCDMA: 900MHz and 2100MHz or multi-band WCDMA: 850MHz, 1900MHz and 2100MHz
  - Supports Quad-band EDGE/GPRS/GSM: 850MHz, 900MHz, 1800MHz, 1900MHz
- Web-based GUI for configuration and management

## Firewall

- Built-in NAT Firewall
- Stateful Packet Inspection (SPI)
- DoS attack prevention
- Supports Web (http)/SSH/FTP/Telnet/SNMP
- Packet Filtering (v4/v6) - port, source IP address, destination IP address

- URL Content Filtering (v4/v6) – string or domain name detection in URL string
- MAC Filtering
- Password protection for system management

## **Quality of Service Control**

- Supports the DiffServ approach
- Traffic prioritization and bandwidth management based-on IPv4/IPv6 protocol, port number and address

## **ATM, PTM and PPP Protocols**

- ATM Adaptation Layer Type 5 (AAL5)
- Multiple Protocol over ALL5 (RFC 268, formerly RFC 1483)
- Bridged or routed Ethernet encapsulation
- VC and LLC based multiplexing
- PPP over Ethernet (PPPoE)
- PPP over ATM (RFC 2364)
- Classical IP over ATM (RFC 1577)
- MAC Encapsulated Routing (RFC 1483 MER)
- OAM F4 / F5

## **IPTV Applications<sup>\*2</sup>**

- IGMP Snooping and IGMP Proxy
- MLD Snooping and MLD Proxy
- Interface Grouping (VLAN)
- Quality of Service (QoS)
- Supports VLAN MUX

## **Wireless LAN**

- Compliant with IEEE 802.11 b/ g/ n standards
- 2.4-2.484GHz radio band for wireless
- Up to 300 Mbps wireless operation rate
- 64 / 128 bits WEP supported for encryption
- WPS (Wi-Fi Protected Setup) for easy setup
- Supports WPS v2
- Wireless Security with WPA-PSK / WPA2-PSK support
- Multiple wireless SSIDs with wireless guest access and client isolation

- WDS repeater function support
- 802.1x radius authentication supported

## **USB Application Server**

- Storage/NAS: Samba server, FTP Server, DLNA media server
- Printer Server

## **Virtual Private Network (VPN)**

- 16 IPSec VPN tunnels
- IKE key management
- DES, 3DES and AES encryption for IPSec
- L2TP over IPSec
- Pap/ Chap/ MS-CHAPv2 authentication for PPTP
- IPSec pass-through
- OpenVPN with CA authentication and extensive OpenSSL encryption
- GRE tunnel

## **Management**

- Easy Sign-on (EZSO)
- Web-based GUI for remote and local management (IPv4/IPv6)
- Firmware upgrades and configuration data upload and download via web-based GUI
- Embedded Telnet server for remote and local management
- Supports DHCP server / client / relay
- Supports SNMP v1,v2, MIB-I and MIB-II
- TR-069\*<sup>1</sup> supports remote management
- Available Syslog
- Mail alert for WAN IP changed
- Auto failover and fallback
- Push Service

# Hardware Specifications

## Physical Interface

- WLAN: internal antennas
- 3G antenna: 3G antenna x 1 PCS<sup>\*3</sup> (only for 3G mode)
- 4G LTE antennas x 2 PCS<sup>\*3</sup> (only for 4G LTE mode)
- DSL: ADSL port
- USB 2.0 port for storage service (Samba, FTP server), printer server
- Ethernet: 4-port 10 / 100Mbps auto-crossover (MDI / MDI-X) Switch
- EWAN: Ethernet port #4 can be configured as a WAN interface for Broadband connectivity.
- Dual SIM card slots
- Factory default reset button
- WPS push button
- Power jack
- Power switch



1. On request for Telco / ISP projects

2. IPTV application may require subscription to IPTV services from a Telco / ISP.

The 3G / 4G LTE data rate is dependent on your local service provider and your 3G / 4G LTE card. The 3G model comes with 1 antenna and 3G/4G LTE model comes with 2 antennas.

4. Specifications on this datasheet are subject to change without prior notice.

# Chapter 2: Installing the Router

## Package Contents

- BiPAC 7820NZ 3G/4G LTE Embedded with Dual-SIM Slots ADSL2+ Wireless-N VPN Firewall Router
- Quick Start Guide
- CD containing the on-line manual
- RJ-45 Cat. 5e STP Ethernet cable
- RJ-11 ADSL/ telephone cable
- Power adapter
- 3G antenna: 3G antenna x 1 PCS (only for 3G mode)
- LTE antennas x 2 PCS (only for LTE mode)
- Splitter / Micro-filter (Optional)

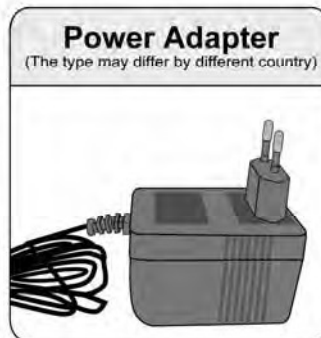
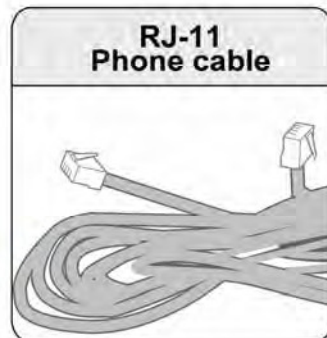
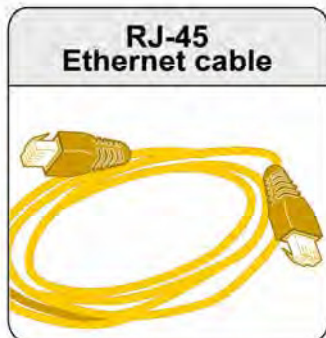

(4G LTE mode)

## Important note for using this router



### Warning

1. Do not use the router in high humidity or high temperatures.
2. Do not use the same power source for the router as other equipment.
3. Do not open or repair the case yourself. If the router is too hot, turn off the power immediately and have it repaired at a qualified service center.
4. Avoid using this product and all accessories outdoors.



### Attention

1. Place the router on a stable surface.
2. Only use the power adapter that comes with the package. Using a different voltage rating power adapter may damage the router.

# Device Description

## The Front LEDs

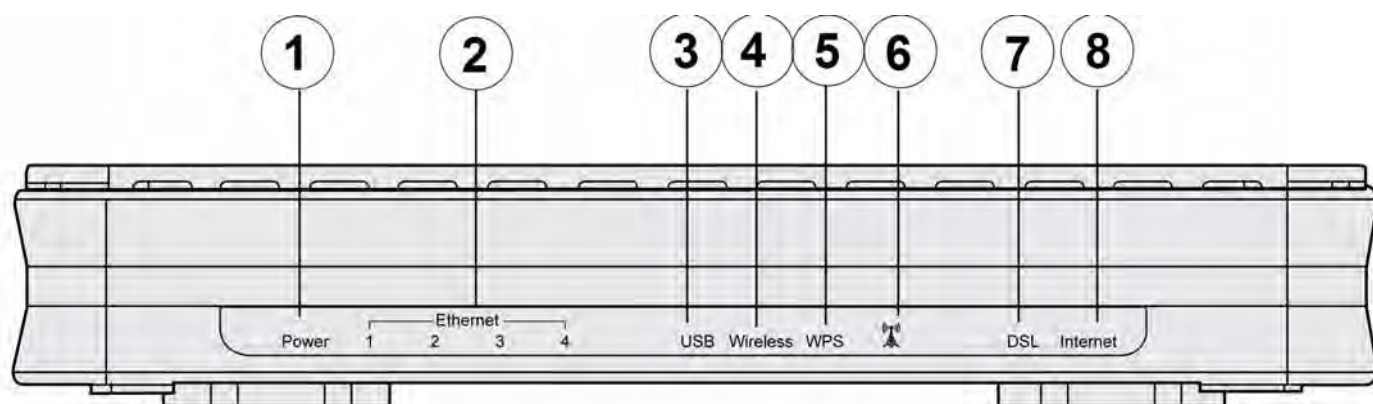

LED		Status	Meaning
1	Power	Red	Boot failure or in emergency mode
		Green	System ready
2	Ethernet Port 1-4 (EWAN)	Green	Transmission speed hitting 10/100Mbps
		Blinking	Data being transmitted/received
3	USB	Green	Connected to the USB device (USB 2.0 Storage, Printer).
4	Wireless	Green	Wireless connection established
		Green blinking	Sending/receiving data
5	WPS	Green blinking	WPS configuration being in progress
		Off	WPS process completed or WPS is off
6	3G/LTE	Green	3G/LTE service(down) is up.
		Slow blinking orange	Weak 3G/LTE signal
		Quick blinking orange	Moderate 3G/LTE signal
		Solid orange	Strong 3G/LTE signal
7	DSL	Green Blinking	DSL synchronizing or waiting for DSL synchronizing
		Green	Successfully connected to an ADSL DSLAM (Line Sync).
		Off	DSL cable unplugged
8	Internet	Green	Having obtained an IP address successfully
		Off	Router in bridge mode or DSL connection not present.

## The Rear Ports

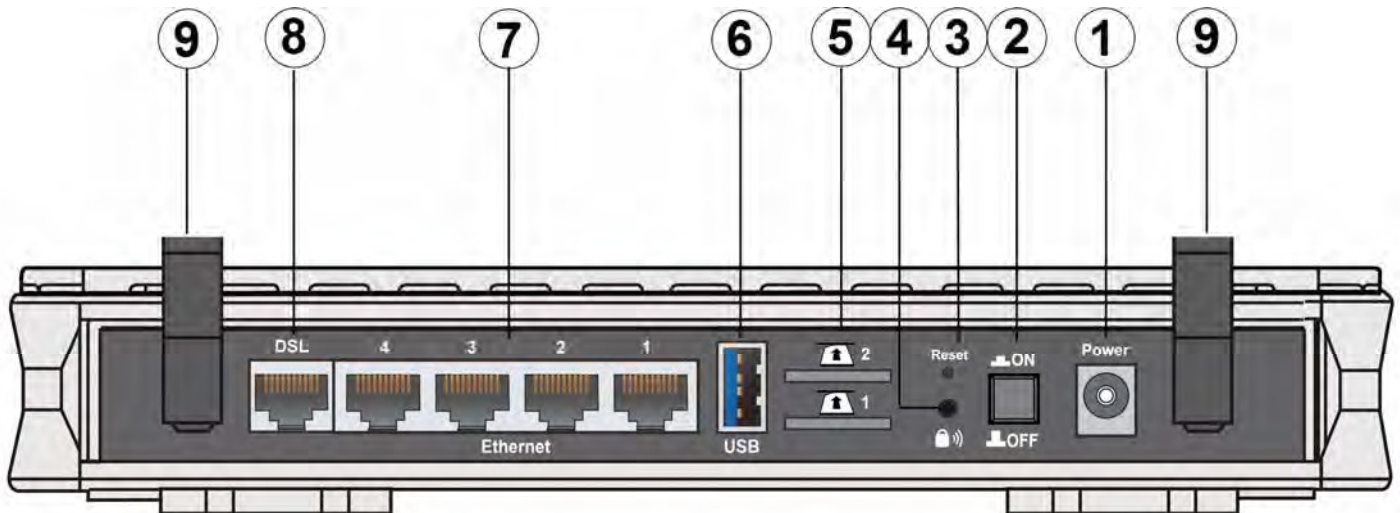

Port		Meaning
1	<b>Power</b>	Connect the supplied power adapter to this jack.
2	<b>Power Switch</b>	Power ON / OFF switch.
3	<b>RESET</b>	After the device is powered on, press it <b>5 seconds or above</b> : to restore to factory default settings (this is used when you cannot login to the router, e.g. forgot the password)
4	<b>WPS</b>	1 <u>WPS button</u> : Push WPS button to trigger Wi-Fi Protected Setup function. 2. <u>Wireless on/off</u> : When WPS is disabled, WPS button can act as wireless on/off button. Press WPS button more than 2 seconds to switch on/off the wireless connectivity,.
5	<b>SIM card slots</b>	BiPAC 7820NZ provides dual-SIM failover mobile connection with two embedded SIM slots. Please plug SIM card into the slot.
6	<b>USB</b>	Connect the USB device (USB 2.0 hard driver, Printer) to this port to server.
7	<b>Ethernet</b>	Connect a UTP Ethernet cable (Cat-5 or Cat-5e) to one of the four LAN ports when connecting to a PC or an office/home network of 10Mbps /100Mbps. <b>Note:</b> Port #4 can be configured as a WAN Interface for Broadband connectivity.
8	<b>DSL</b>	Connect this port to the DSL network with the RJ-11 cable (telephone) provided.
8	<b>Antennas</b>	The detachable antennas. • 3G antenna: 3G antenna x 1 PCS (only for 3G mode) • 4G LTE antennas x 2 PCS (only for 4G LTE mode)



# Cabling

One of the most common causes of problems is bad cabling or ADSL line(s). Make sure that all connected devices are turned on. On the front panel of your router is a bank of LEDs. Verify that the LAN Link and ADSL line LEDs are all lit. If they are not, verify if you are using the proper cables. If the error persists, you may have a hardware problem. In this case, you should contact technical support.

Make sure you have a line filter with all devices (e.g. telephones, fax machines, analogue modems) connected to the same telephone line and the wall socket (unless you are using a Central Splitter or Central Filter installed by a qualified and licensed electrician), and ensure that all line filters are correctly installed and the right way around. Missing line filters or line filters installed the wrong way around can cause problems with your ADSL connection, including causing frequent disconnections. If you have a back-to-base alarm system you should contact your security provider for a technician to make any necessary changes.

# Chapter 3: Basic Installation

The router can be configured through your web browser. A web browser is included as a standard application in the following operating systems: Linux, Mac OS, Windows 7 / 98 / NT / 2000 / XP / Me / Vista, etc. The product provides an easy and user-friendly interface for configuration.

Please check your PC network components. The TCP/IP protocol stack and Ethernet network adapter must be installed. If not, please refer to your Windows-related or other operating system manuals.

There are ways to connect the router, either through an external repeater hub or connect directly to your PCs. However, make sure that your PCs have an Ethernet interface installed properly prior to connecting the router device. You ought to configure your PCs to obtain an IP address through a DHCP server or a fixed IP address that must be in the same subnet as the router. The default IP address of the router is 192.168.1.254 and the subnet mask is 255.255.255.0 (i.e. any attached PC must be in the same subnet, and have an IP address in the range of 192.168.1.1 to 192.168.1.253). The best and easiest way is to configure the PC to get an IP address automatically from the router using DHCP. If you encounter any problem accessing the router web interface it is advisable to uninstall your firewall program on your PCs, as they can cause problems accessing the IP address of the router. Users should make their own decisions on what is best to protect their network.

Please follow the following steps to configure your PC network environment.



Any TCP/IP capable workstation can be used to communicate with or through this router. To configure other types of workstations, please consult your manufacturer documentation.

# Connecting Your Router

Users can connect the Dual-SIM 3G/4G LTE ADSL2+ router as the following.

**Note:** BiPAC 7820NZ offers different mobile antennas distribution for 3G and 4G/LTE mode for an optimal performance. Here, we take the 4G LTE mode for an example in the illustration.

- 3G antenna: 3G antenna x 1 PCS
- 4G LTE antennas x 2 PCS

## ADSL Router mode:

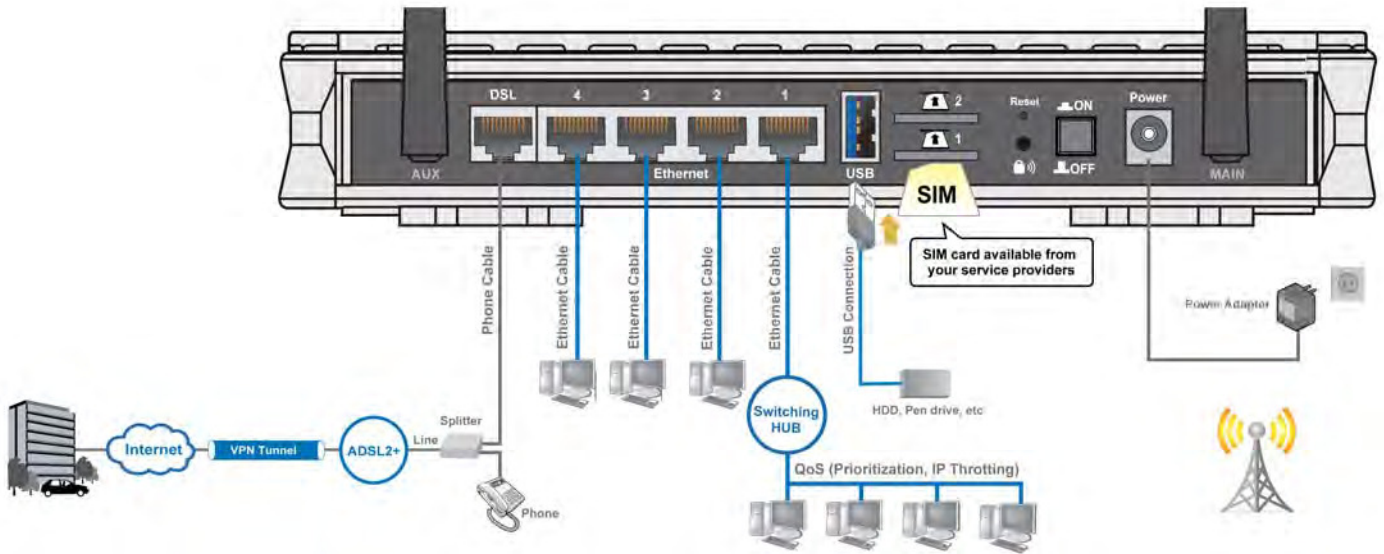

## Broadband Router mode:

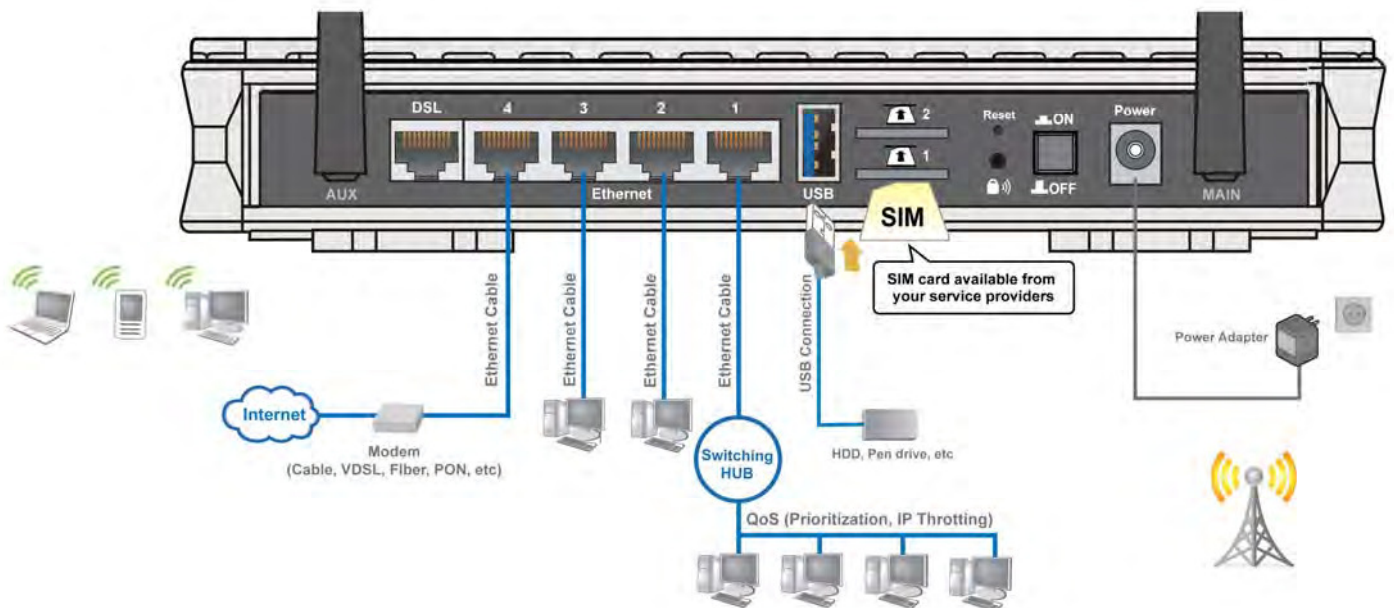

# 3G/4G LTE Router mode

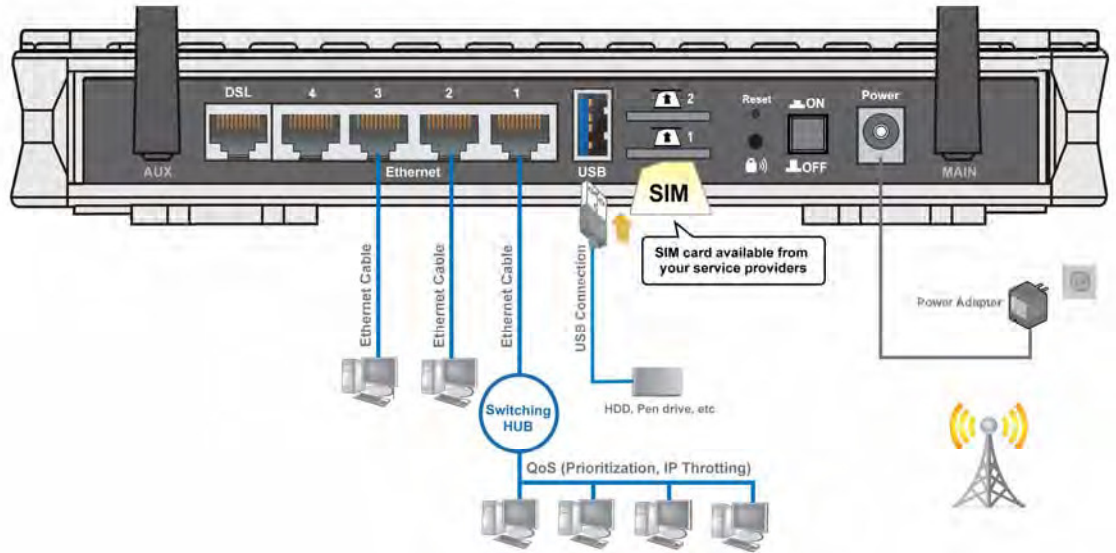

# Network Configuration

## Configuring a PC in Windows 7/8

1. Go to **Start**. Click on **Control Panel**. Then click on **Network and Internet**.

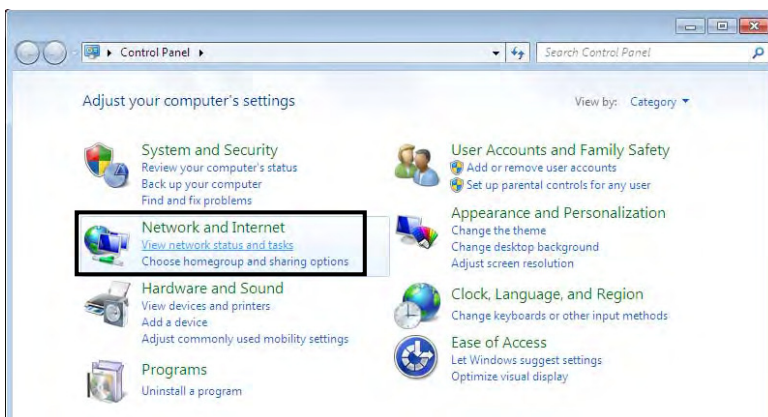

2. When the **Network and Sharing Center** window pops up, select and click on **Change adapter settings** on the left window panel.

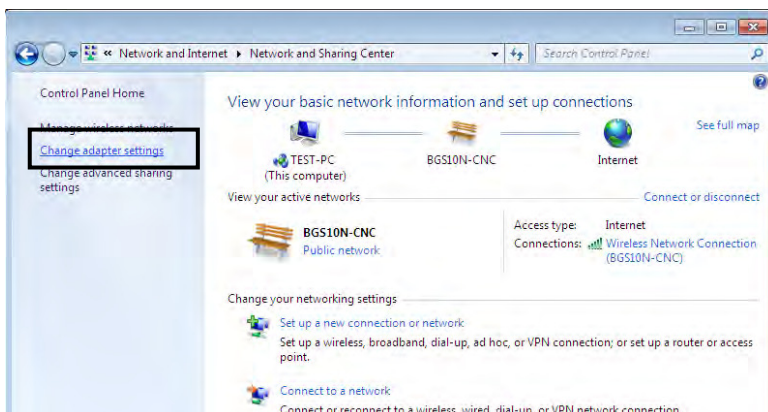

3. Select the **Local Area Connection**, and right click the icon to select **Properties**.

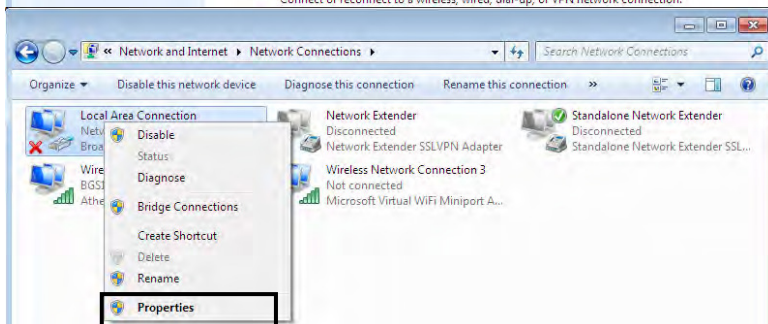

## IPv4:

4. Select **Internet Protocol Version 4 (TCP/IPv4)** then click **Properties**

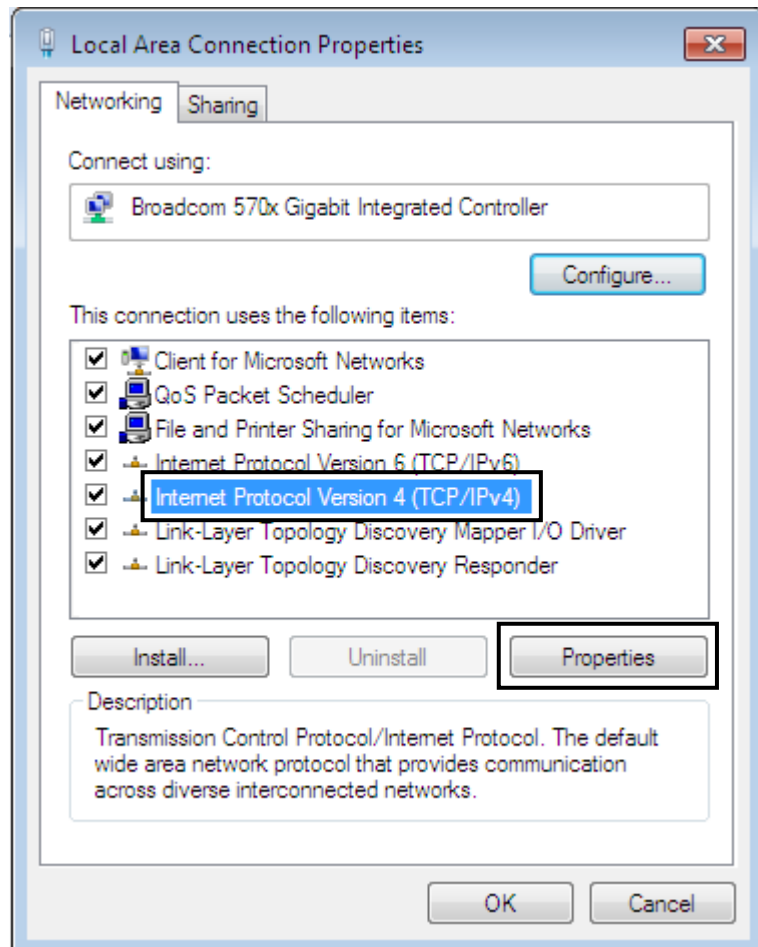

5. In the **TCP/IPv4 properties** window, select the **Obtain an IP address automatically** and **Obtain DNS Server address automatically** radio buttons. Then click **OK** to exit the setting.
6. Click **OK** again in the **Local Area Connection Properties** window to apply the new configuration.

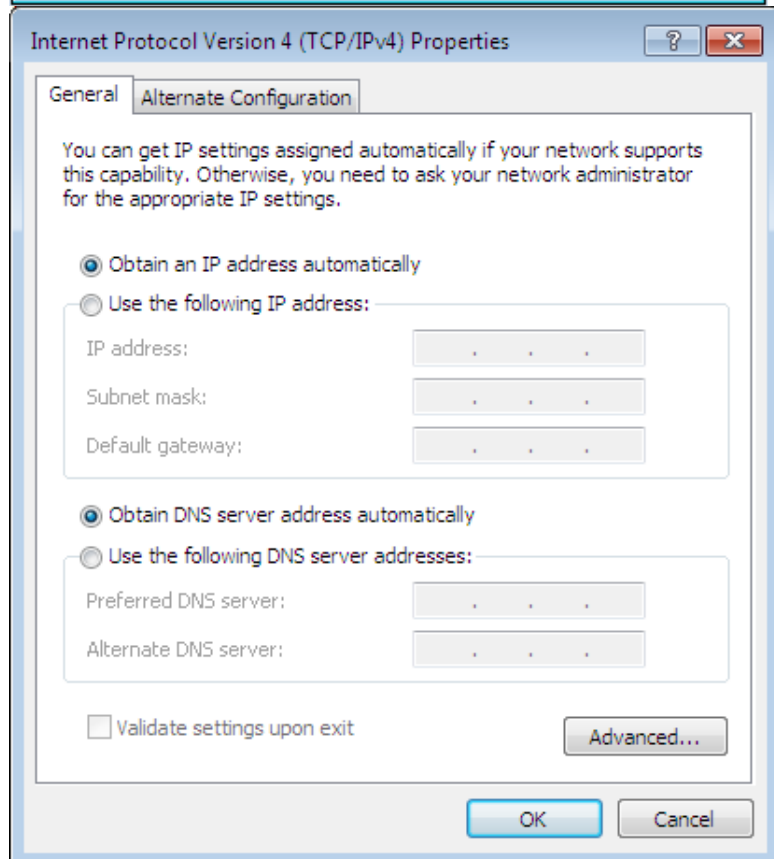

## IPv6:

4. Select **Internet Protocol Version 6 (TCP/IPv6)** then click **Properties**

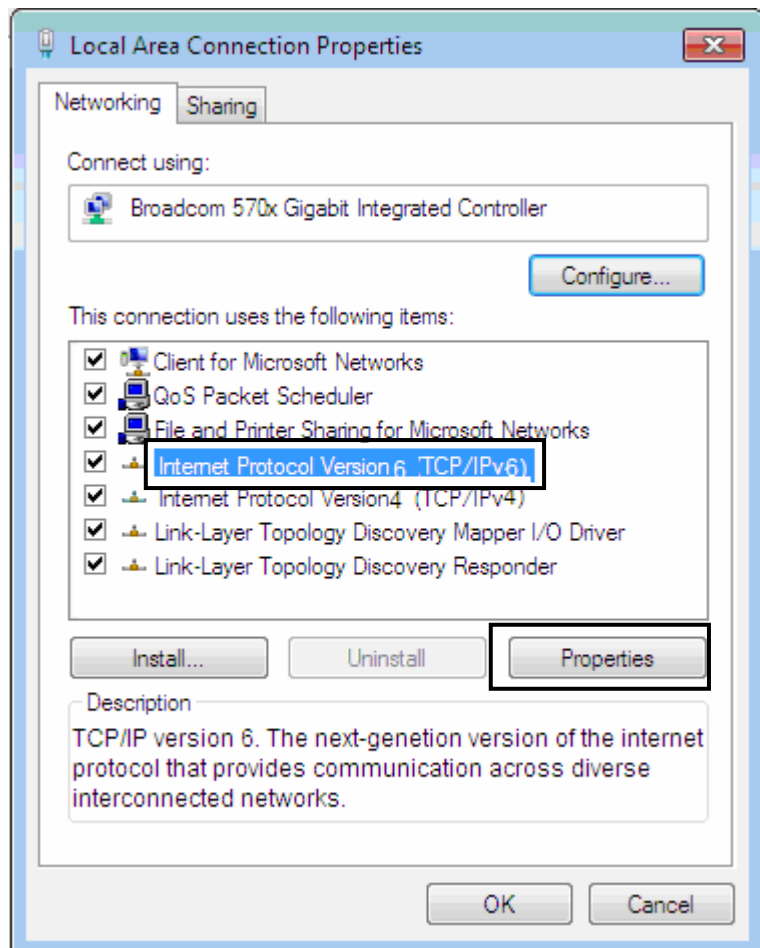

5. In the **TCP/IPv6 properties** window, select the **Obtain an IPv6 address automatically** and **Obtain DNS Server address automatically** radio buttons. Then click **OK** to exit the setting.
6. Click **OK** again in the **Local Area Connection Properties** window to apply the new configuration.

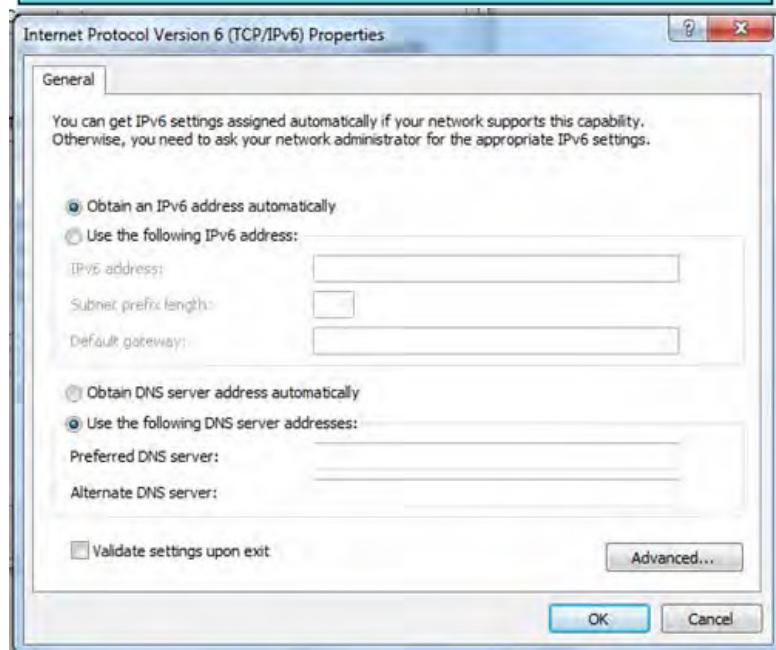

# Configuring a PC in Windows Vista

1. Go to **Start**. Click on **Network**.
2. Then click on **Network and Sharing Center** at the top bar.

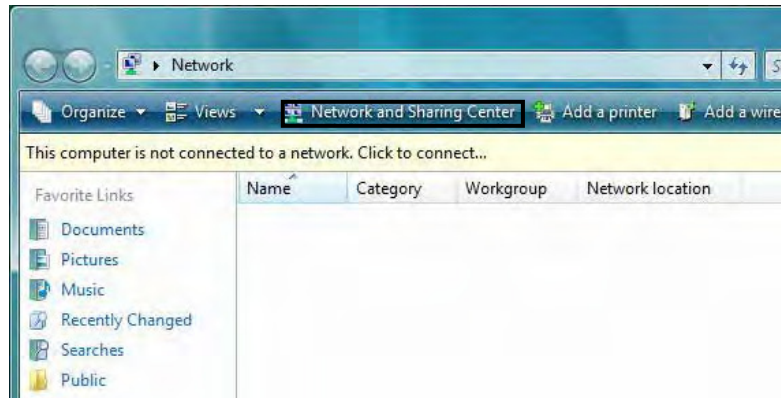

3. When the **Network and Sharing Center** window pops up, select and click on **Manage network connections** on the left window pane.



4. Select the **Local Area Connection**, and right click the icon to select **Properties**.

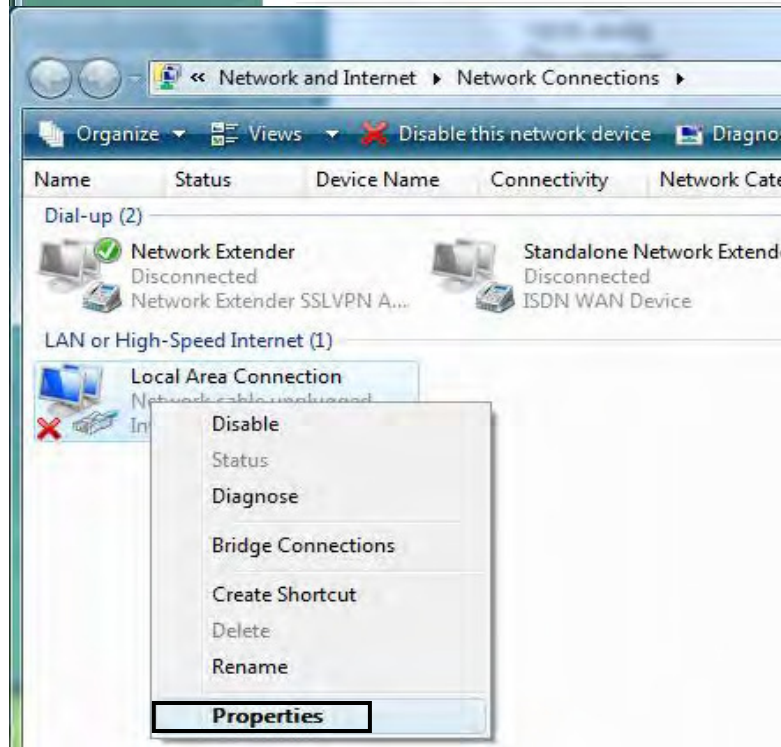



## IPv4:

5. Select **Internet Protocol Version 4 (TCP/IPv4)** then click **Properties**.

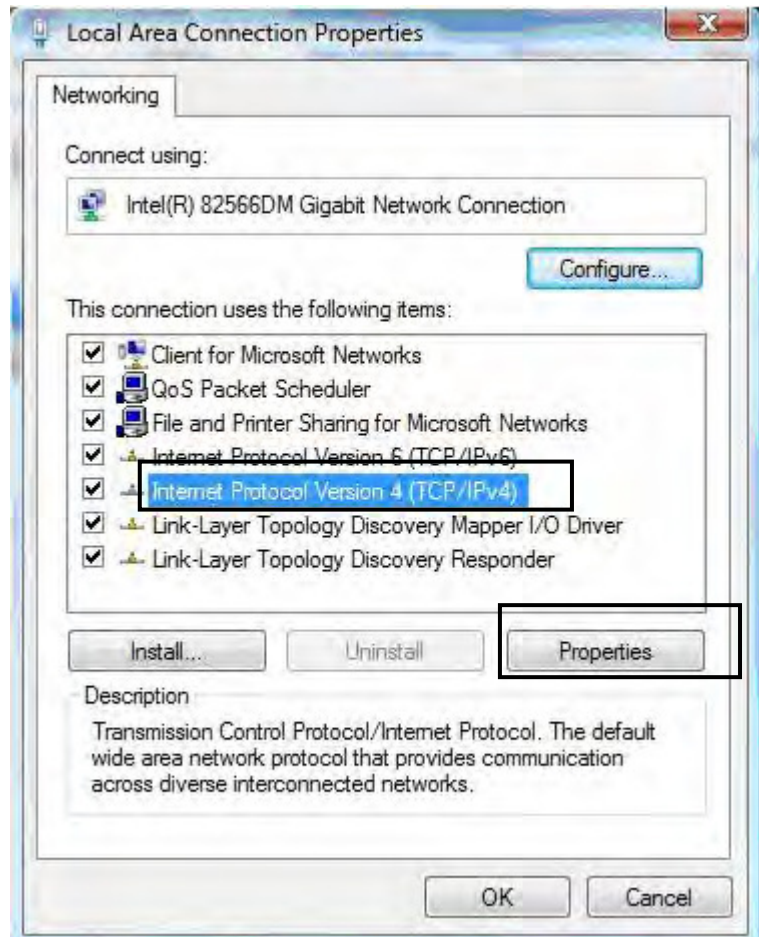

6. In the **TCP/IPv4 properties** window, select the **Obtain an IP address automatically** and **Obtain DNS Server address automatically** radio buttons. Then click **OK** to exit the setting.
7. Click **OK** again in the **Local Area Connection Properties** window to apply the new configuration.

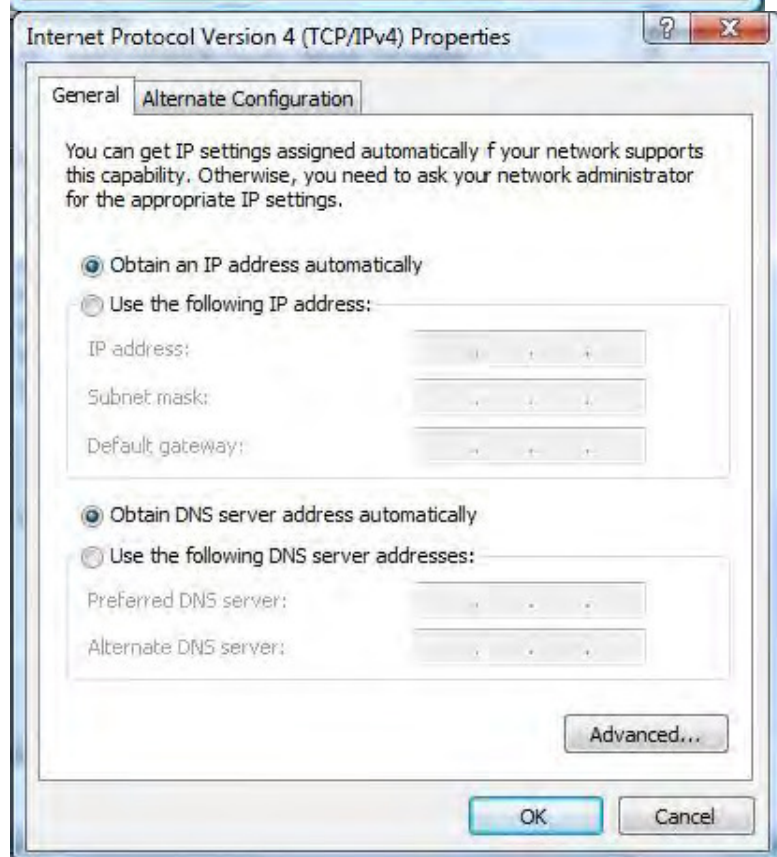

## IPv6:

8. Select **Internet Protocol Version 6 (TCP/IPv6)** then click **Properties**.

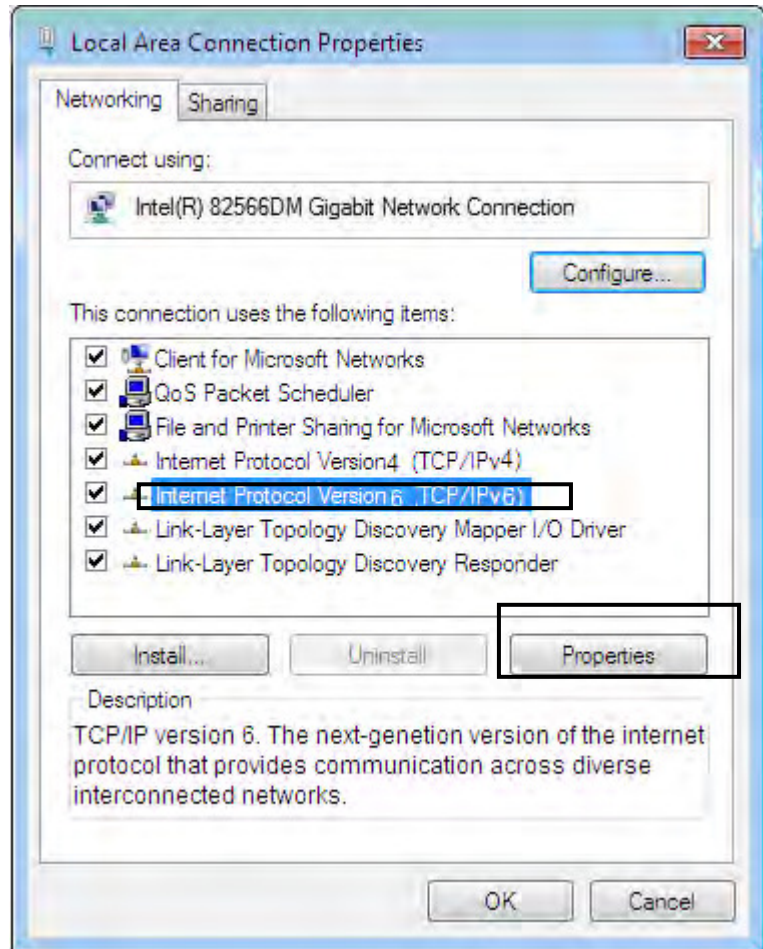

9. In the **TCP/IPv6 properties** window, select the **Obtain an IPv6 address automatically** and **Obtain DNS Server address automatically** radio buttons. Then click **OK** to exit the setting.
10. Click **OK** again in the **Local Area Connection Properties** window to apply the new configuration.

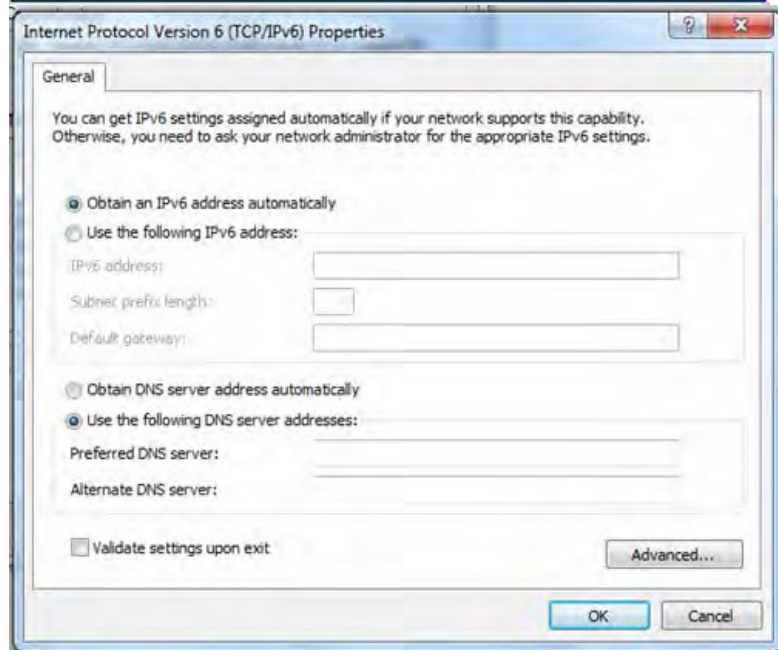

# Configuring a PC in Windows XP

## IPv4:

1. Go to **Start / Control Panel (in Classic View)**. In the Control Panel, double-click on **Network Connections**

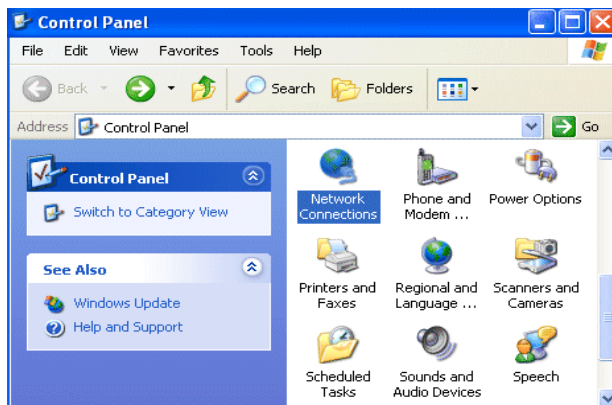

2. Double-click **Local Area Connection**.

3. In the **Local Area Connection Status** window, click **Properties**.

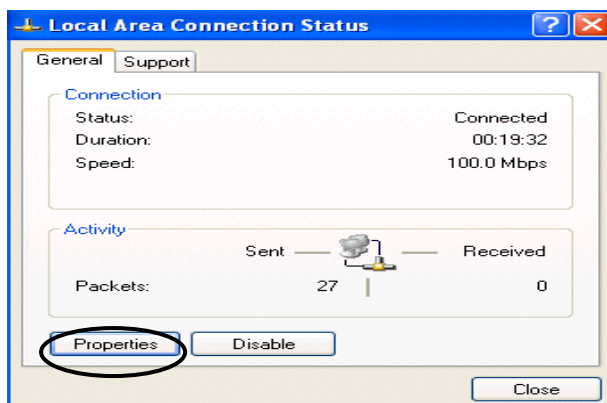

4. Select **Internet Protocol (TCP/IP)** and click **Properties**.

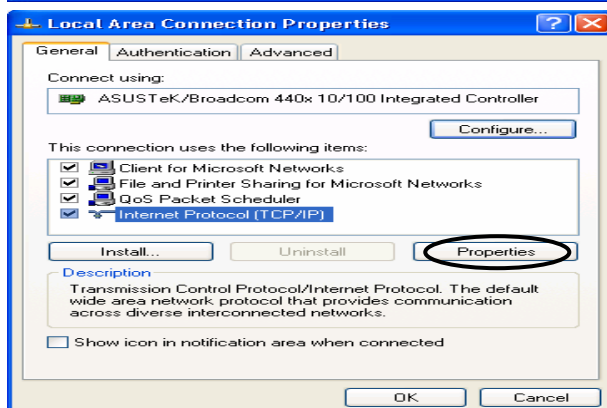

5. Select the **Obtain an IP address automatically** and the **Obtain DNS server address automatically** radio buttons.

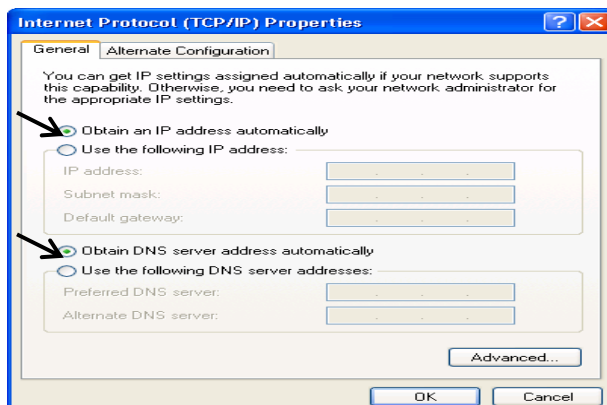

6. Click **OK** to finish the configuration.

## IPv6:

IPv6 is supported by Windows XP, but you should install it first.

Act as shown below:

1. On the desktop, Click Start > Run, type cmd, then press Enter key in the keyboard, the following screen appears.

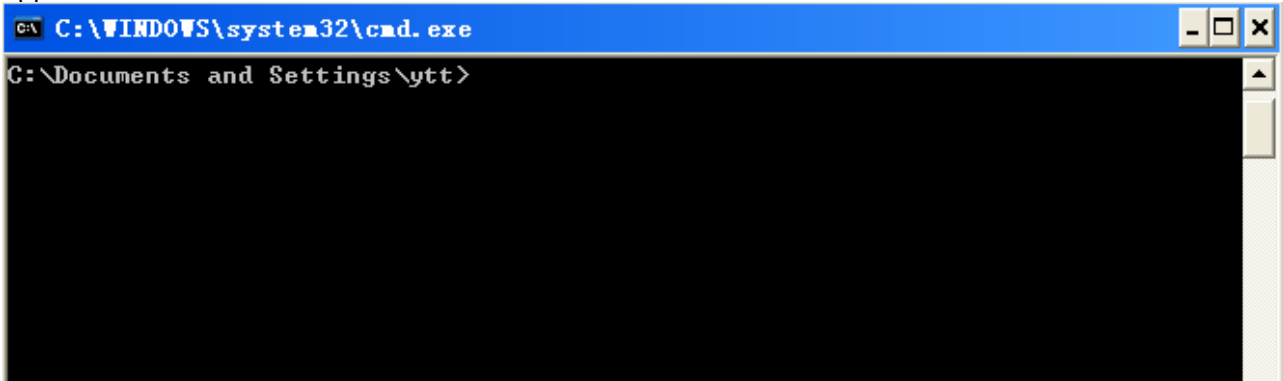

```
C:\WINDOWS\system32\cmd.exe
C:\Documents and Settings\ytt>
```

2. Key in command **ipv6 install**

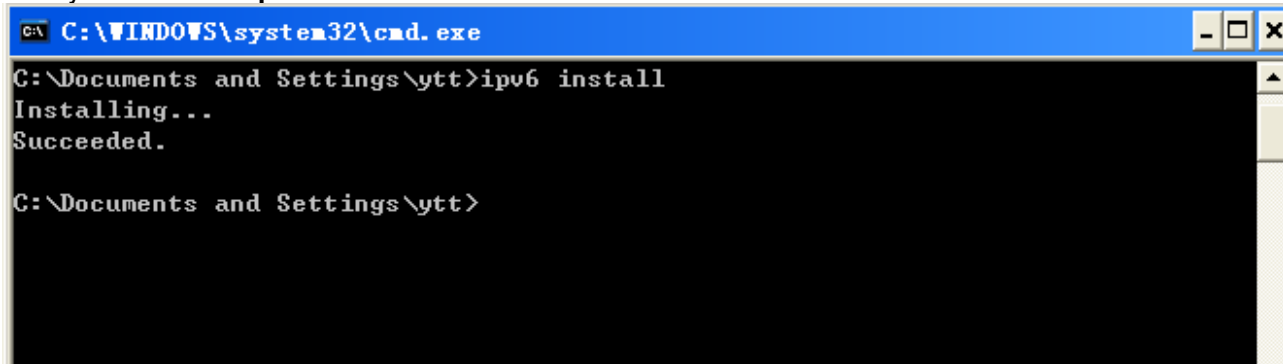

```
C:\WINDOWS\system32\cmd.exe
C:\Documents and Settings\ytt>ipv6 install
Installing...
Succeeded.
C:\Documents and Settings\ytt>
```

Configuration is OK now, you can test whether it works ok.

# Factory Default Settings

Before configuring your router, you need to know the following default settings.

## Web Interface (Username and Password)

Three user levels are provided by this router, namely **Administrator**, **Remote** and **Local** respectively. See [Access Control](#) .

### Administrator

- ▶ Username: admin
- ▶ Password: admin

### Local

- ▶ Username: user
- ▶ Password: user

### Remote

- ▶ Username: support
- ▶ Password: support



**Attention**

If you have forgotten the username and/or password of the router, you can restore the device to its default setting by pressing the **Reset Button** more than **5** seconds.

## Device LAN IPv4 settings

- ▶ IPv4 Address: 192.168.1.254
- ▶ Subnet Mask: 255.255.255.0

## Device LAN IPv6 settings

- ▶ IPv6 Address / prefix: Default is a link-local address and is different from each other as MAC address is different from one to one. For example: fe80:0000:0000:0000:0204:edff:fe01:0001 / 64, the prefix initiates by fe80::

## DHCP server for IPv4

- ▶ DHCP server is enabled.
- ▶ Start IP Address: 192.168.1.100
- ▶ IP pool counts: 100

## LAN and WAN Port Addresses

The parameters of LAN and WAN ports are pre-set in the factory. The default values are shown in the table.

### IPv4

LAN Port		WAN Port
IPv4 address	192.168.1.254	The PPPoE function is enabled to automatically get the WAN port configuration from the ISP.
Subnet Mask	255.255.255.0	
DHCP server function	Enabled	
IP addresses for distribution to PCs	100 IP addresses continuing from 192.168.1.100 through 192.168.1.199	

### IPv6

LAN Port		WAN Port
IPv6 address/prefix	Default is a link-local address and is different from each other as MAC address is different from one to one. For example fe80::204:edff:fe01:1/64, the prefix initiates by fe80::	The PPPoE function is enabled to automatically get the WAN port configuration from the ISP.
DHCP server function	Enabled	

## Information from your ISP

Before configuring this device, you have to check with your ISP (Internet Service Provider) to find out what kind of service is provided.

Gather the information as illustrated in the following table and keep it for reference.

PPPoE(RFC2516)	VPI/VCI, VC / LLC-based multiplexing, Username, Password, Service Name, and Domain Name System (DNS) IP address (it can be automatically assigned by your ISP when you connect or be set manually).
PPPoA(RFC2364)	VPI/VCI, VC / LLC-based multiplexing, Username, Password and Domain Name System (DNS) IP address (it can be automatically assigned by your ISP when you connect or be set manually).
DHCP Client	VPI/VCI, VC / LLC-based multiplexing, Domain Name System (DNS) IP address (it can be automatically assigned by your ISP when you connect or be set manually).
IPoA(RFC1577)	VPI/VCI, VC / LLC-based multiplexing, IP address, Subnet mask, Gateway address, and Domain Name System (DNS) IP address (it is a fixed IP address).
Pure Bridge	VPI/VCI, VC / LLC-based multiplexing to use Bridged Mode.

# Easy Sign On (EZSO)

This special feature makes it easier for you to configure your router so that you can connect to the internet in a matter of seconds without having to logon to the router GUI for any detail configuration. This configuration method is usually auto initiated if user is to connect to the internet via Billion's router for the first time.

After setting up the router with all the appropriate cables plugged-in, open up your IE browser, the EZSO WEB GUI will automatically pop up and request that you enter some basic information that you have obtained from your ISP. By following the instructions given carefully and through the information you provide, the router will be configured in no time and you will find yourself surfing the internet sooner than you realize.

## EZSO window pops up:

**Step 1:** Set the administration password.

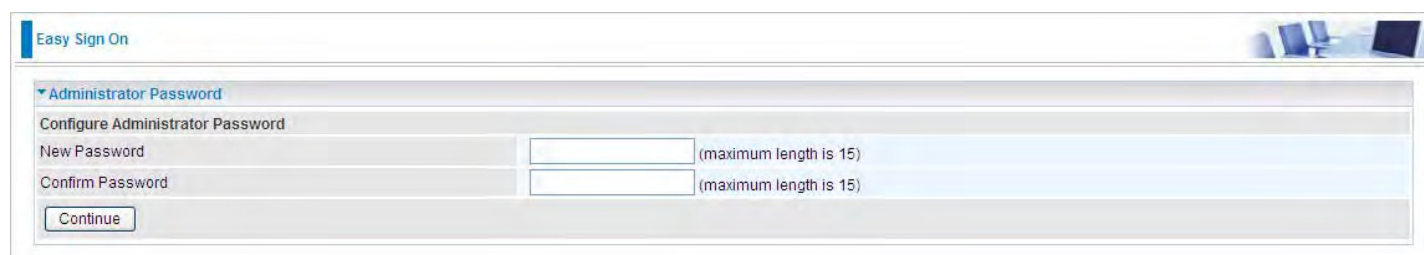

The screenshot shows the 'Easy Sign On' window with the 'Administrator Password' section expanded. It contains the following fields and controls:

- Configure Administrator Password**
- New Password**: A text input field with a note '(maximum length is 15)' to its right.
- Confirm Password**: A text input field with a note '(maximum length is 15)' to its right.
- Continue**: A button located below the input fields.

**Step 2:** Set the Time Zone.



The screenshot shows the 'Easy Sign On' window with the 'Time Zone' section expanded. It contains the following fields and controls:

- Configure Time Zone Offset**
- Time zone offset**: A dropdown menu showing '(GMT-00:00) Greenwich Mean Time: Dublin, Edinburgh, Lisbon, London'.
- Continue**: A button located below the dropdown menu.

**Step 3:** Configure the WAN interface.

## DSL mode

Before configuring with DSL mode, please confirm you have correctly connected the DSL line, and it is now synchronized.

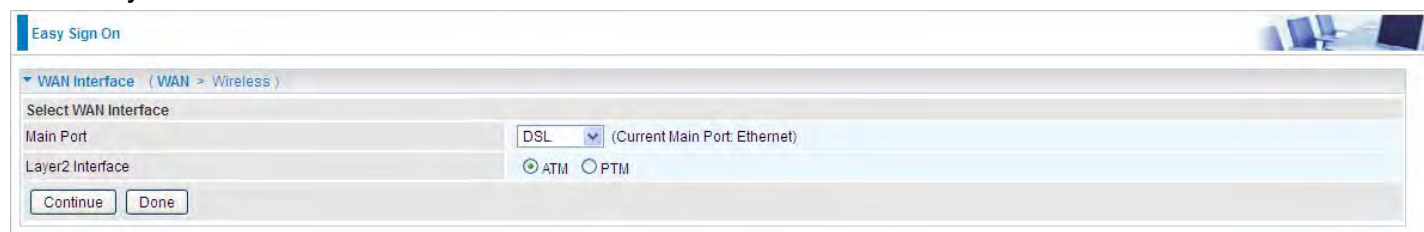

The screenshot shows the 'Easy Sign On' window with the 'WAN Interface' section expanded. It contains the following fields and controls:

- Select WAN Interface**
- Main Port**: A dropdown menu showing 'DSL' with a note '(Current Main Port: Ethernet)' to its right.
- Layer2 Interface**: Radio buttons for 'ATM' (selected) and 'PTM'.
- Continue** and **Done**: Buttons located below the interface selection options.

1. Select DSL, press **Continue** to go on to next step, press "Done" to quit the setting.



2. Enter the username, password from your ISP, for IP and DNS settings; also refer to your ISP. Here IPv6 service is enabled by default.

The screenshot shows the 'WAN Service' configuration page. The 'Type' is set to 'PPP over Ethernet (PPPoE)'. The 'VPI / VCI' field is set to '[0-255] / [32-65535]'. The 'Authentication Method' is set to 'AUTO'. The 'Encapsulation Mode' is set to 'LLC/SNAP-BRIDGING'. The 'IPv4 Address' section has the 'Static' checkbox unchecked. The 'IPv6 for this service' checkbox is checked and labeled 'Enable'. The 'MTU' is set to '1492'. A 'Continue' button is at the bottom left.

If the DSL line doesn't synchronize, the page will pop up warning of the DSL connection failure.

The screenshot shows a warning message: 'DSL Line Is Not Ready. Please Check your DSL Line and wait for a while.'

3. Wait while the device is configured (DSL synchronized).

The screenshot shows a message: 'Please wait while the device is configured.'

4. WAN port configuration is success and next to wireless, if you want skip wireless setting, click **Done**.

The screenshot shows a success message: 'Congratulations ! Your WAN port has been successfully configured.' Below the message are two buttons: 'Next to Wireless' and 'Done'.

Click **Done**, web configuration will be loaded, you will enter the web configuration page.

The screenshot shows a message: 'Stop EZSO You stopped the EZSO procedure. Web Configuration will now load.'

5. After the configuration is successful, click **Next to Wireless** button and you may proceed to configure the Wireless setting. Enable the wireless and set the SSID and encryption Key. (1. Leave it empty to disable the wireless security; 2. Fill in the Key, and the encryption mode will be WPA2-PSK/AES).

Easy Sign On

Wireless (WAN > Wireless)

Parameters

Wireless  Enable

SSID

WPA2 Pre-Shared Key  [Click here to display](#)

Easy Sign On

Wireless (WAN > Wireless)

Please wait while the device is configured.

6. Success in configuring the EZSO.

Easy Sign On

Process finished

Success.

The Easy-Sign-On process is finished. Your device has been successfully configured.

You can now:

1. Log onto the router management interface for more advanced settings on [192.168.1.254](http://192.168.1.254)
2. Continue to [wpad.home.gateway/wpad.dat](http://wpad.home.gateway/wpad.dat)

Click link **192.168.1.254**, it will lead you to the following page.

Status

Device Information

Model Name	BIPAC 7820NZ
Host Name	home.gateway
System Up-Time	0D 19H 44M 28S
Date/Time	Tue Mar 31 03:03:39 2015 <input type="button" value="Sync"/>
Software Version	2.32e
LAN IPv4 Address	192.168.1.254
LAN IPv6 Address	2000:1211:1000:4d0b:204:edff:fe01:1/64
MAC Address	00:04:ed:01:00:01
DSL PHY and Driver Version	A2pD038f.d24h
Wireless Driver Version	6.30.102.7.cpe4.12L08.4

WAN

Line Rate - Upstream (Kbps)	1291
Line Rate - Downstream (Kbps)	26919
Default Gateway / IPv4 Address	ppp0.1 (DSL) / 10.40.90.211
Connection Time	00:02:44
Primary DNS Server	218.2.135.1
Secondary DNS Server	218.2.135.1
Default IPv6 Gateway / IPv6 Address	ppp0.1 (DSL) / 2000:db98:1000:1000:29ac:afc6:59a4:5816/64

## Ethernet mode

1. Select **Ethernet**, press **Continue** to go on to next step.

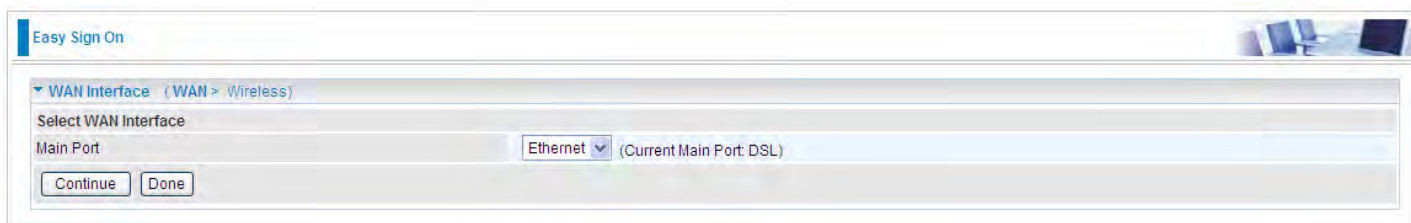

Easy Sign On

WAN Interface (WAN > Wireless)

Select WAN Interface

Main Port Ethernet (Current Main Port: DSL)

2. Enter the username, password from your ISP, for IP and DNS settings, also refer to your ISP. Here IPv6 service is enabled by default.

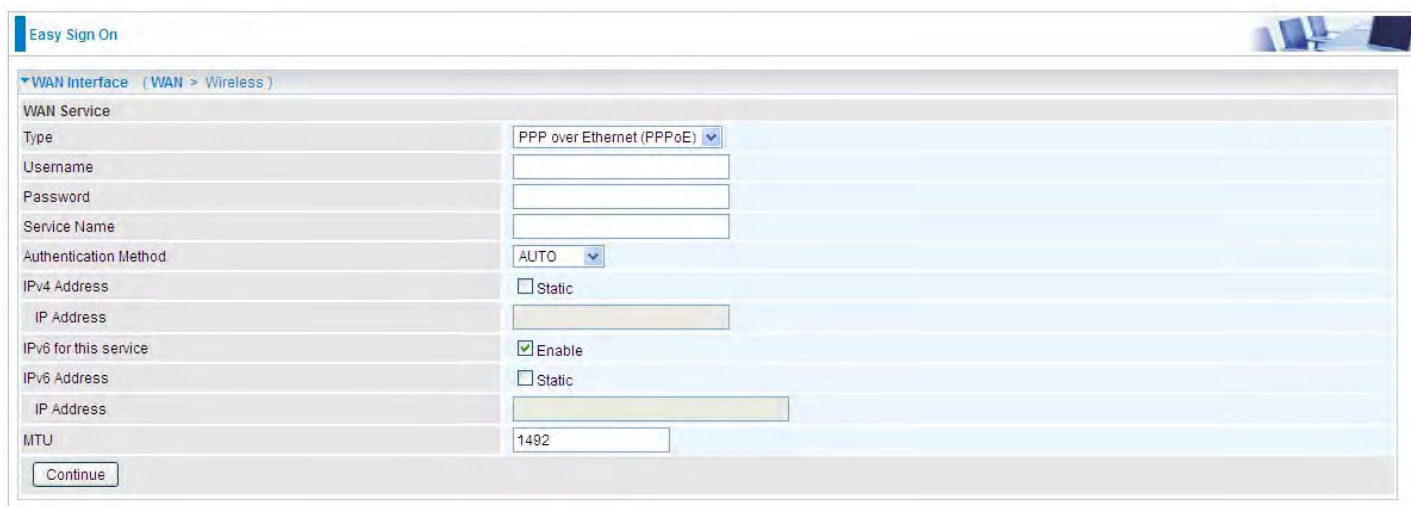

Easy Sign On

WAN Interface (WAN > Wireless)

WAN Service

Type PPP over Ethernet (PPPoE)

Username

Password

Service Name

Authentication Method AUTO

IPv4 Address  Static

IP Address

IPv6 for this service  Enable

IPv6 Address  Static

IP Address

MTU

3. Wait while the device is configured.



Easy Sign On

WAN Interface (WAN > Wireless)

Please wait while the device is configured.

4. WAN port configuration is success.

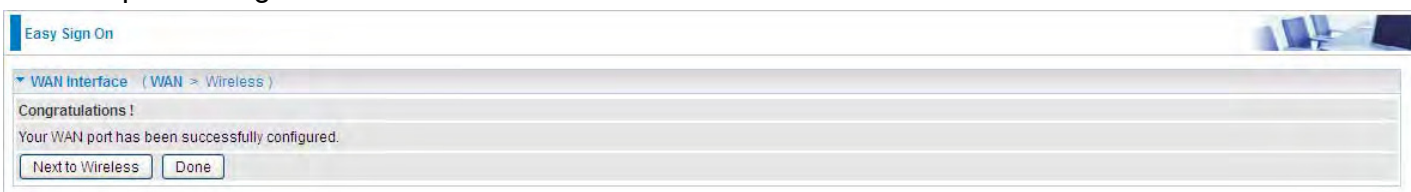

Easy Sign On

WAN Interface (WAN > Wireless)

Congratulations !

Your WAN port has been successfully configured.

Click **Done**, web configuration will be loaded, you will enter the web configuration page.



Easy Sign On

WAN Interface

Stop EZSO

You stopped the EZSO procedure. Web Configuration will now load.

5. After the configuration is successful, click **Next to Wireless** button and you may proceed to configure the Wireless setting. Enable wireless and set the SSID and encryption Key (1. Leave it empty to disable the wireless security; 2. Fill in the Key, and the encryption mode will be WPA2-PSK/AES).



The screenshot shows the 'Easy Sign On' configuration page for Wireless settings. The page has a header 'Easy Sign On' and a sub-header 'Wireless (WAN > Wireless)'. Under the 'Parameters' section, there are three fields: 'Wireless' with a checked 'Enable' checkbox, 'SSID' with the value 'wlan-ap-2.4g', and 'WPA2 Pre-Shared Key' which is empty. A 'Continue' button is located at the bottom left of the configuration area. A link 'Click here to display' is next to the WPA2 Pre-Shared Key field.



The screenshot shows the 'Easy Sign On' configuration page for Wireless settings. The page has a header 'Easy Sign On' and a sub-header 'Wireless (WAN > Wireless)'. The main content area displays the message: 'Please wait while the device is configured.'

6. Success in configuring the EZSO.



The screenshot shows the 'Easy Sign On' configuration page for Wireless settings. The page has a header 'Easy Sign On' and a sub-header 'Process finished'. The main content area displays the message: 'Success. The Easy-Sign-On process is finished. Your device has been successfully configured. You can now: 1. Log onto the router management interface for more advanced settings on 192.168.1.254 2. Continue to wpad.home.gateway/wpad.dat'. The IP address and URL are highlighted in blue.

## 3G/LTE

1. Select **3G/LTE**, press **Continue** to go on to next step.

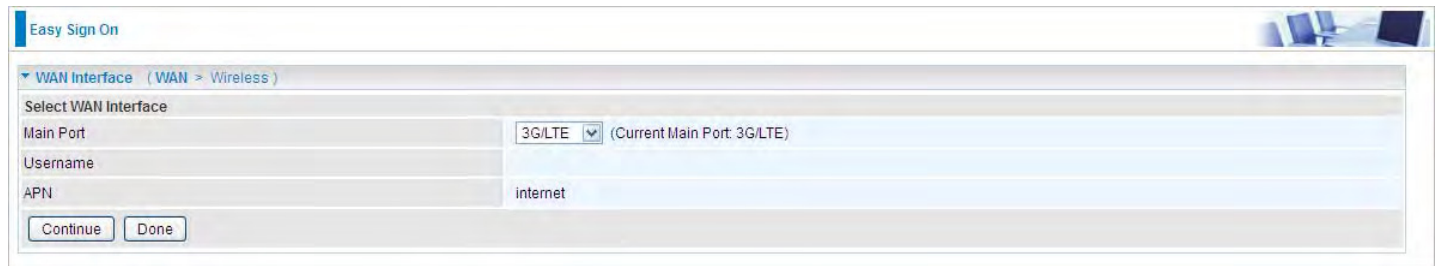

Easy Sign On

WAN Interface (WAN > Wireless)

Select WAN Interface

Main Port: 3G/LTE (Current Main Port: 3G/LTE)

Username: [Empty]

APN: internet

Continue Done

2. Select the 3G/LTE mode, and enter the APN, username, password from your ISP; and check with your ISP with the authentication method setting for each SIM (SIM1 and SIM2).

**Note:** Given that BiPAC 7820NZ supports dual -SIM mobile connectivity, please determine which SIM you are gonna use or both (3G/LTE failover), and set the exact required connecting information for each SIM (SIM1 and SIM2).

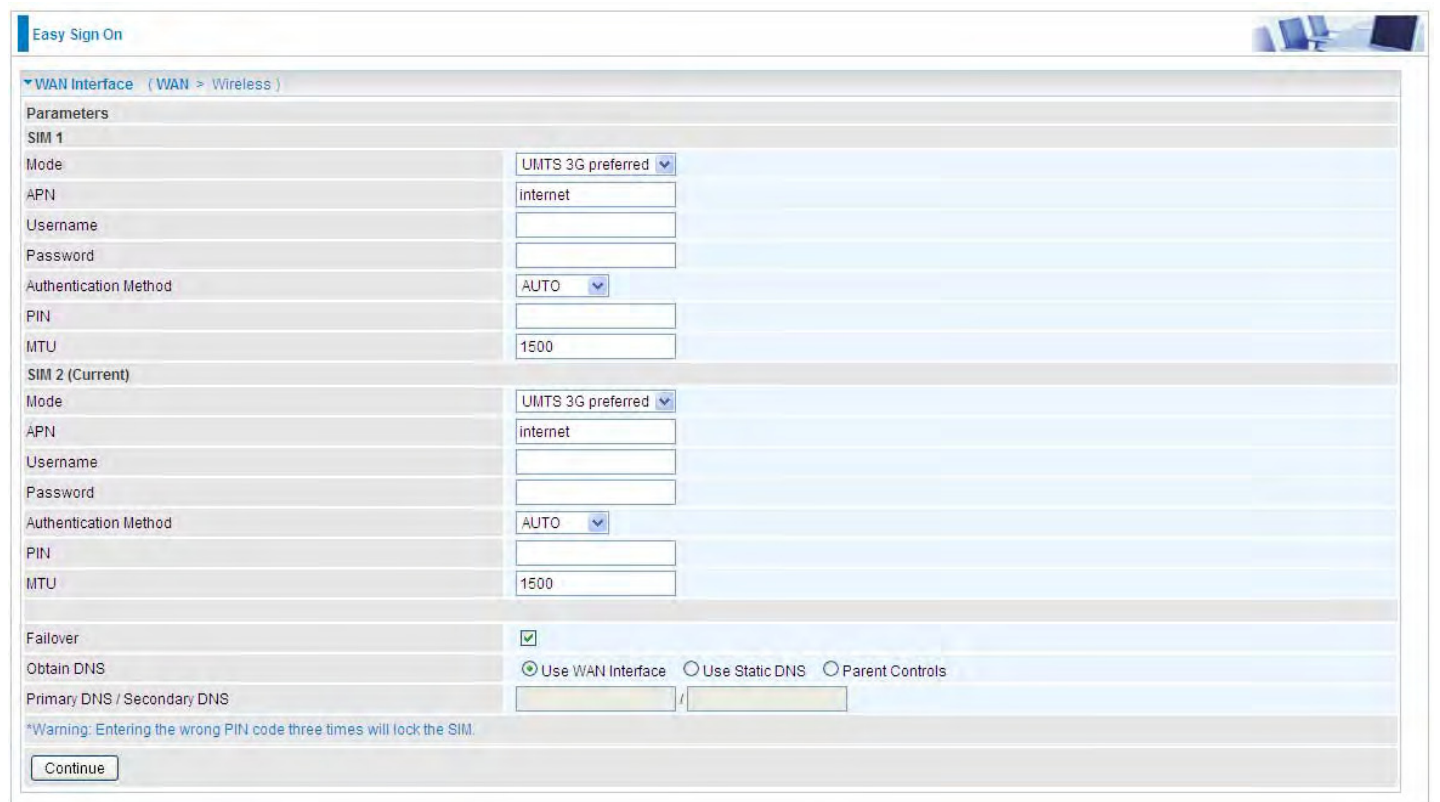

Easy Sign On

WAN Interface (WAN > Wireless)

Parameters

SIM 1

Mode: UMTS 3G preferred

APN: internet

Username: [Empty]

Password: [Empty]

Authentication Method: AUTO

PIN: [Empty]

MTU: 1500

SIM 2 (Current)

Mode: UMTS 3G preferred

APN: internet

Username: [Empty]

Password: [Empty]

Authentication Method: AUTO

PIN: [Empty]

MTU: 1500

Failover:

Obtain DNS:  Use WAN Interface  Use Static DNS  Parent Controls

Primary DNS / Secondary DNS: [Empty] / [Empty]

\*Warning: Entering the wrong PIN code three times will lock the SIM.

Continue

3. Wait while the device is configured.



Easy Sign On

WAN Interface (WAN > Wireless)

Please wait while the device is configured.

4. WAN port configuration is success.

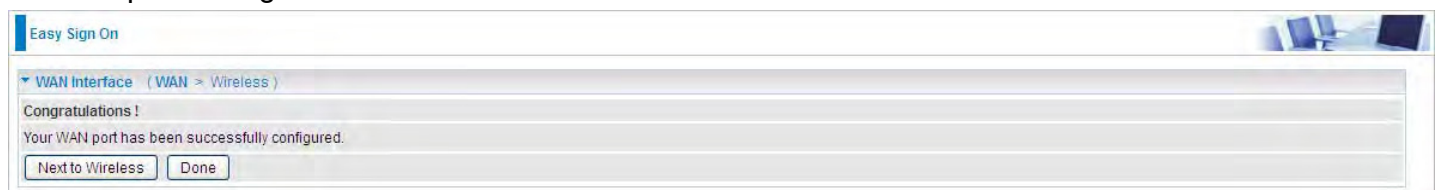

Easy Sign On

WAN Interface (WAN > Wireless)

Congratulations!

Your WAN port has been successfully configured.

Next to Wireless Done

Click **Done**, web configuration will be loaded, you will enter the web configuration page.



5. After the configuration is successful, click **Next to Wireless** button and you may proceed to configure the Wireless setting. Enable wireless and set the SSID and encryption Key (1. Leave it empty to disable the wireless security; 2. Fill in the Key, and the encryption mode will be WPA2-PSK/AES).



7. Success in configuring the EZSO.

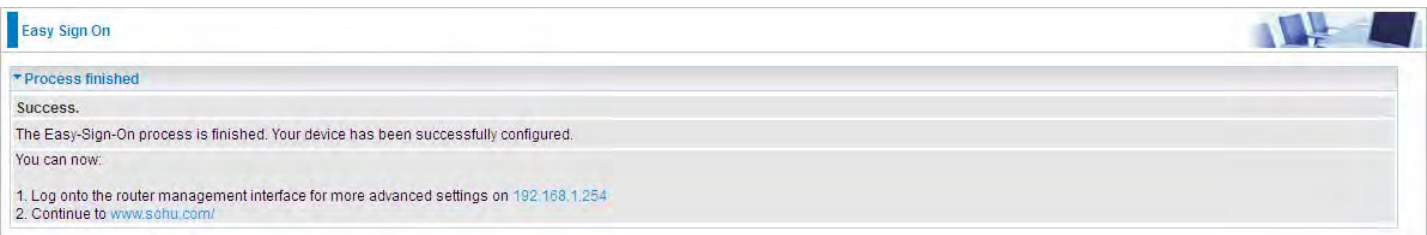

# Chapter 4: Configuration

## Configuration via Web Interface

Open your web browser; enter the IP address of your router, which by default is 192.168.1.254, and click  or press 'Enter' key on the keyboard, a login prompt window will appear. The default root username and password are "admin" and "admin" respectively.

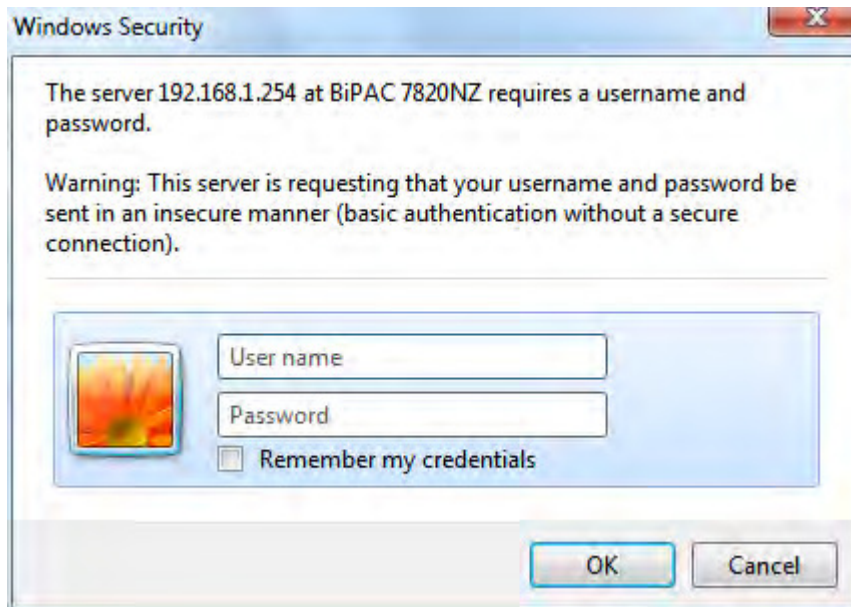

**Congratulations! You are now successfully logged on to the Triple WAN ADSL2+ Firewall Router!**

Once you have logged on to your BiPAC 7820NZ Router via your web browser, you can begin to set it up according to your requirements. On the configuration homepage, the left navigation pane links you directly to the setup pages, which include:

● **Status** (Summary, WAN, Statistics, Bandwidth Usage, Route, 3G/LTE Status, Route, ARP, DHCP, VPN, Log, VRRP Status)

● **Quick Start** (Quick Start)

● **Configuration** (LAN, Wireless, WAN, System, USB, IP Tunnel, Security, Quality of Service, NAT, Wake On LAN)

● **VPN** (IPSec, VPN Account, Exceptional Rule Group, PPTP, L2TP, OpenVPN, GRE)

● **Advanced Setup** (Routing, DNS, Static ARP, UPnP, Certificate, Multicast, Management, Diagnostics)



# Status

This Section gives users an easy access to the information about the working router and access to view the current status of the router. Here [Summary](#), [WAN](#), [Statistics](#), [Bandwidth Usage](#), [3G/LTE Status](#), [Route](#), [ARP](#), [DHCP](#), [VPN](#), [Log](#) and [VRRP Status](#) subsections are included.

▼ Status
▪ Summary
▪ WAN
▶ Statistics
▶ Bandwidth Usage
▪ 3G/LTE Status
▪ Route
▪ ARP
▪ DHCP
▶ VPN
▶ Log
▪ VRRP Status
▪ Quick Start
▶ Configuration
▶ VPN
▶ Advanced Setup

# Summary

The basic information about the device is provided here (the following is a configured screenshots to let users understand clearly).

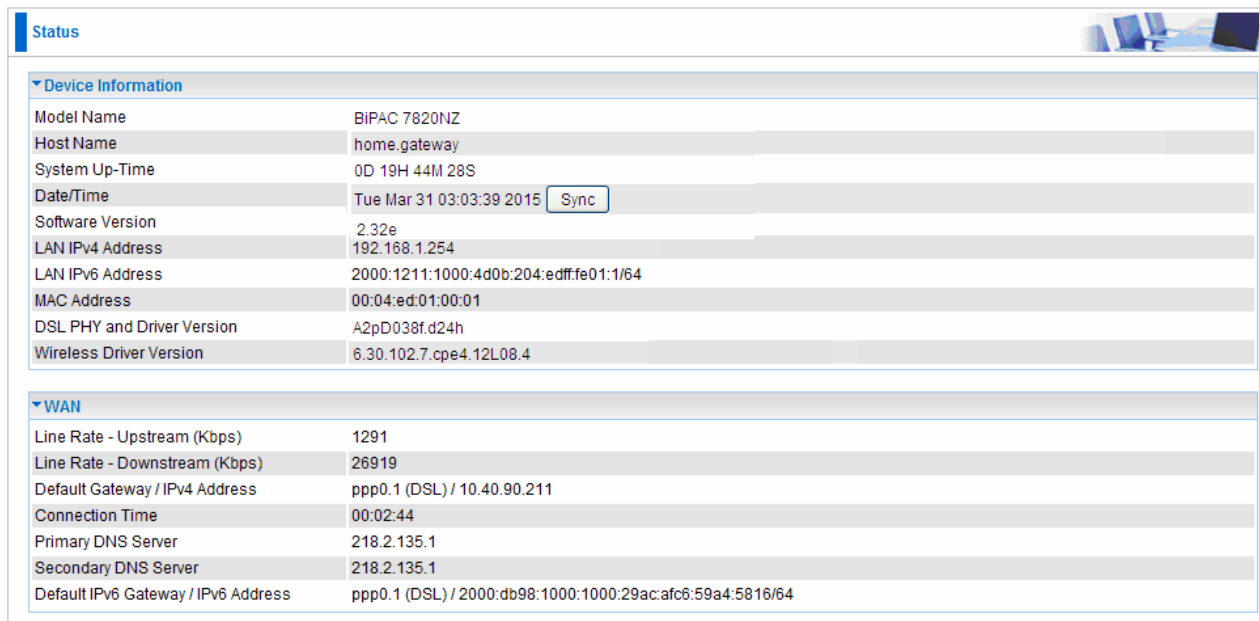

The screenshot shows a web interface for a router's status page. At the top left, there is a 'Status' tab. Below it, there are two main sections: 'Device Information' and 'WAN'. The 'Device Information' section contains fields for Model Name (BIPAC 7820NZ), Host Name (home.gateway), System Up-Time (0D 19H 44M 28S), Date/Time (Tue Mar 31 03:03:39 2015) with a 'Sync' button, Software Version (2.32e), LAN IPv4 Address (192.168.1.254), LAN IPv6 Address (2000:1211:1000:4d0b:204:edff:fe01:1/64), MAC Address (00:04:ed:01:00:01), DSL PHY and Driver Version (A2pD038f.d24h), and Wireless Driver Version (6.30.102.7.cpe4.12L08.4). The 'WAN' section contains fields for Line Rate - Upstream (Kbps) (1291), Line Rate - Downstream (Kbps) (26919), Default Gateway / IPv4 Address (ppp0.1 (DSL) / 10.40.90.211), Connection Time (00:02:44), Primary DNS Server (218.2.135.1), Secondary DNS Server (218.2.135.1), and Default IPv6 Gateway / IPv6 Address (ppp0.1 (DSL) / 2000:db98:1000:1000:29ac:afc6:59a4:5816/64).

Device Information	
Model Name	BIPAC 7820NZ
Host Name	home.gateway
System Up-Time	0D 19H 44M 28S
Date/Time	Tue Mar 31 03:03:39 2015 <input type="button" value="Sync"/>
Software Version	2.32e
LAN IPv4 Address	192.168.1.254
LAN IPv6 Address	2000:1211:1000:4d0b:204:edff:fe01:1/64
MAC Address	00:04:ed:01:00:01
DSL PHY and Driver Version	A2pD038f.d24h
Wireless Driver Version	6.30.102.7.cpe4.12L08.4

WAN	
Line Rate - Upstream (Kbps)	1291
Line Rate - Downstream (Kbps)	26919
Default Gateway / IPv4 Address	ppp0.1 (DSL) / 10.40.90.211
Connection Time	00:02:44
Primary DNS Server	218.2.135.1
Secondary DNS Server	218.2.135.1
Default IPv6 Gateway / IPv6 Address	ppp0.1 (DSL) / 2000:db98:1000:1000:29ac:afc6:59a4:5816/64

## Device Information

**Model Name:** Displays the model name.

**Host Name:** Displays the name of the router.

**System Up-Time:** Displays the elapsed time since the device is on.

**Date/Time:** Displays the current exact date and time. Sync button is to synchronize the Date/Time with your PC time without regard to connecting to internet or not.

**Software Version:** Firmware version.

**LAN IPv4 Address:** Displays the LAN IPv4 address.

**LAN IPv6 Address:** Displays the LAN IPv6 address. Default is a Link-Local address, but when connects to ISP, it will display the Global Address, like above figure.

**MAC Address:** Displays the MAC address.

**DSL PHY and Driver Version:** Display DSL PHY and Driver version.

**Wireless Driver Version:** Displays wireless driver version.

## WAN

**Line Rate – Upstream (Kbps):** Displays Upstream line Rate in Kbps.

**Line Rate – Downstream (Kbps):** Displays Downstream line Rate in Kbps.

**Default Gateway/IPv4 Address:** Display Default Gateway and the IPv4 address.

**Connection Time:** Displays the elapsed time since ADSL connection is up.

**Primary DNS Server:** Displays IPV4 address of Primary DNS Server.

**Secondary DNS Server:** Displays IPV4 address of Secondary DNS Server.

**Default IPv6 Gateway/IPv6 Address:** Display the IPv6 Gateway and the obtained IPv6 address.

# WAN

This table displays the information of the WAN connections, users can turn here for WAN connection information.

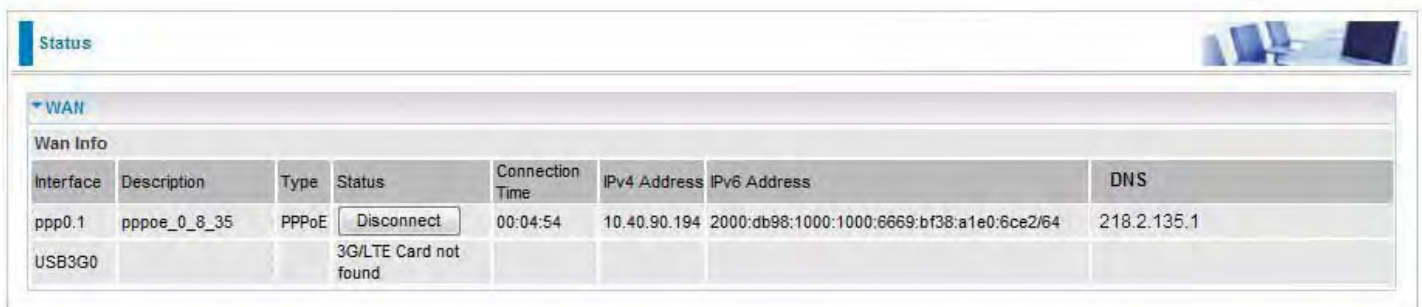

The screenshot shows a 'Status' page with a 'WAN' section. Under 'WAN Info', there is a table with columns: Interface, Description, Type, Status, Connection Time, IPv4 Address, IPv6 Address, and DNS. The table contains two rows: one for 'ppp0.1' which is connected with a 'Disconnect' button, and one for 'USB3G0' which is disconnected because the '3G/LTE Card not found'.

Interface	Description	Type	Status	Connection Time	IPv4 Address	IPv6 Address	DNS
ppp0.1	pppoe_0_8_35	PPPoE	<input type="button" value="Disconnect"/>	00:04:54	10.40.90.194	2000:db98:1000:1000:6669:bf38:a1e0:6ce2/64	218.2.135.1
USB3G0			3G/LTE Card not found				

**Interface:** The WAN connection interface.

**Description:** The description of this connection.

**Type:** The protocol used by this connection.

**Status:** To disconnect or connect the link.

**Connection Time:** The WAN connection time since WAN is up.

**IPv4 Address:** The WAN IPv4 Address the device obtained.

**IPv6 Address:** The WAN IPv6 Address the device obtained.

**DNS:** The DNS address the device obtained.

# Statistics

## LAN

The table shows the statistics of LAN.

**Note:** P4 can be configured as EWAN, and when the device is in EWAN profile, there is no P4/EWAN interface as P4 is working as a WAN port.

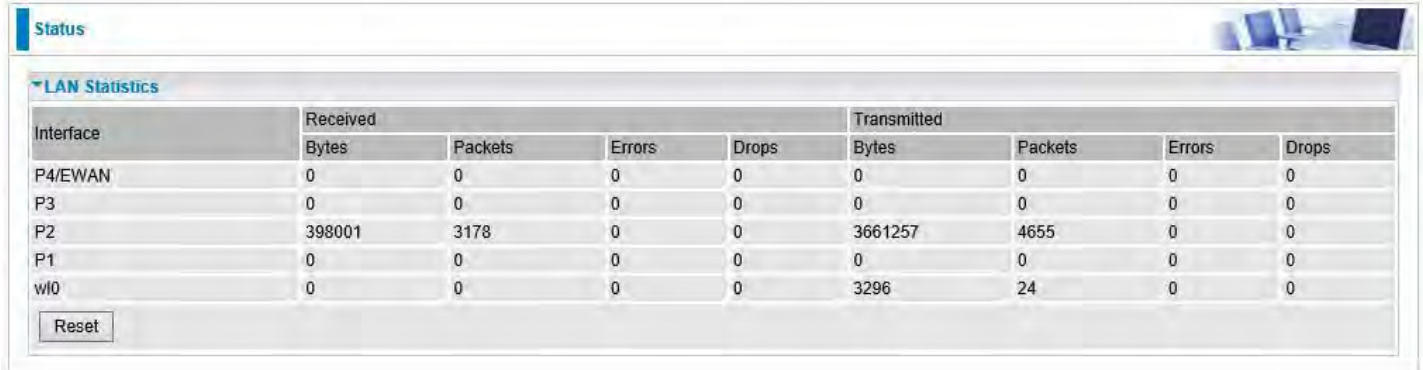

The screenshot shows a web interface with a 'Status' tab and a 'LAN Statistics' section. The table displays statistics for five interfaces: P4/EWAN, P3, P2, P1, and w10. The 'Reset' button is visible at the bottom left.

Interface	Received				Transmitted			
	Bytes	Packets	Errors	Drops	Bytes	Packets	Errors	Drops
P4/EWAN	0	0	0	0	0	0	0	0
P3	0	0	0	0	0	0	0	0
P2	398001	3178	0	0	3661257	4655	0	0
P1	0	0	0	0	0	0	0	0
w10	0	0	0	0	3296	24	0	0

(DSL)

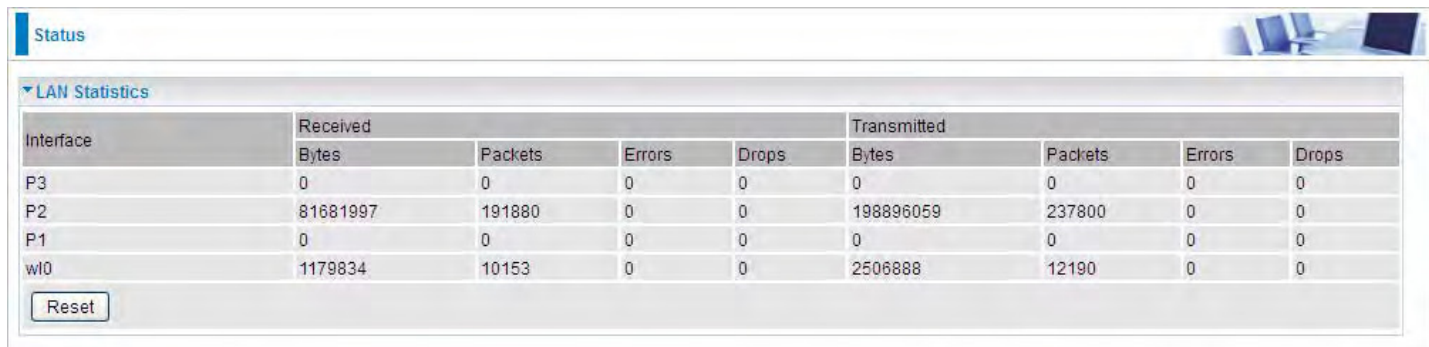

The screenshot shows a web interface with a 'Status' tab and a 'LAN Statistics' section. The table displays statistics for five interfaces: P3, P2, P1, and w10. The 'Reset' button is visible at the bottom left.

Interface	Received				Transmitted			
	Bytes	Packets	Errors	Drops	Bytes	Packets	Errors	Drops
P3	0	0	0	0	0	0	0	0
P2	81681997	191880	0	0	198896059	237800	0	0
P1	0	0	0	0	0	0	0	0
w10	1179834	10153	0	0	2506888	12190	0	0

(EWAN)

**Interface:** List each LAN interface. P1-P4 indicates the four LAN interfaces.

**Bytes:** Display the Received and Transmitted traffic statistics in Bytes.

**Packets:** Display the Received and Transmitted traffic statistics in Packets.

**Errors:** Display the statistics of errors arising in Receiving or Transmitting data.

**Drops:** Display the statistics of drops arising in Receiving or Transmitting data.

**Reset:** Press this button to refresh the statistics.

## WAN Service

The table shows the statistics of WAN.

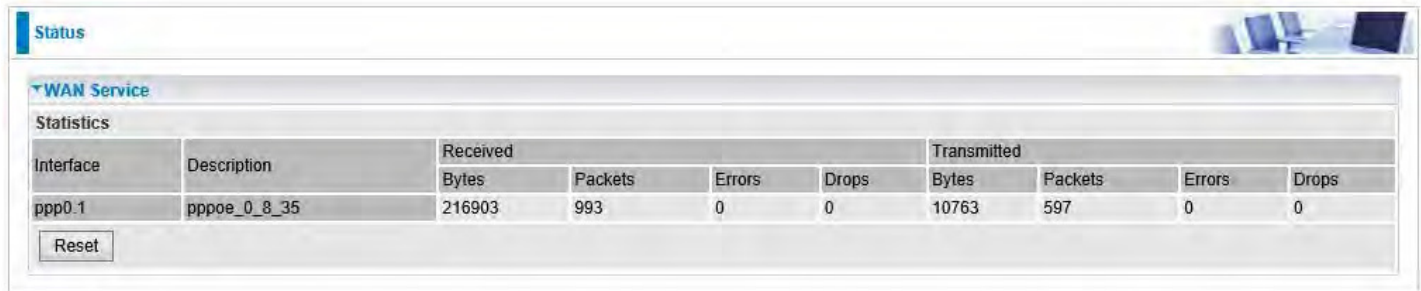

The screenshot shows a web interface with a 'Status' tab and a 'WAN Service' section. Under 'Statistics', there is a table with columns for Interface, Description, Received (Bytes, Packets, Errors, Drops), and Transmitted (Bytes, Packets, Errors, Drops). A 'Reset' button is located below the table.

Interface	Description	Received				Transmitted			
		Bytes	Packets	Errors	Drops	Bytes	Packets	Errors	Drops
ppp0.1	pppoe_0_8_35	216903	993	0	0	10763	597	0	0

**Interface:** Display the connection interface.

**Description:** the description for the connection.

**Bytes:** Display the WAN Received and Transmitted traffic statistics in Bytes.

**Packets:** Display the WAN Received and Transmitted traffic statistics in Packests.

**Errors:** Display the statistics of errors arising in Receiving or Transmitting data.

**Drops:** Display the statistics of drops arising in Receiving or Transmitting data.

**Reset:** Press this button to refresh the statistics.

## xTM

The Statistics-xTM screen displays all the xTM statistics

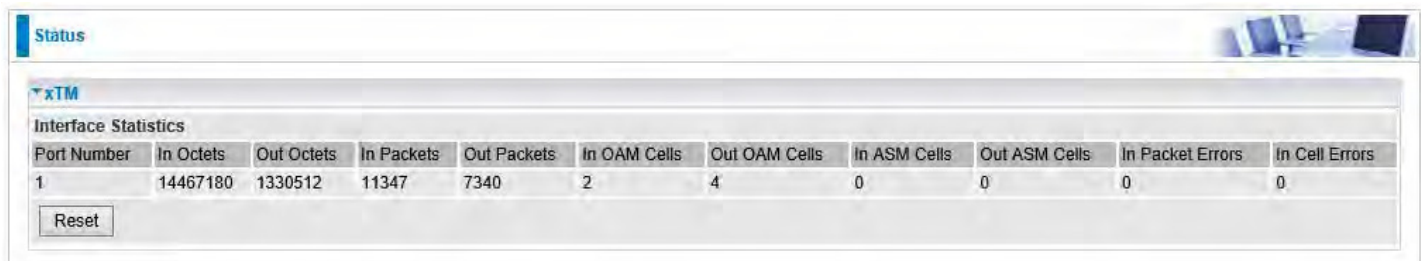

The screenshot shows a web interface with a 'Status' tab and an 'xTM' section. Under 'Interface Statistics', there is a table with columns for Port Number, In Octets, Out Octets, In Packets, Out Packets, In OAM Cells, Out OAM Cells, In ASM Cells, Out ASM Cells, In Packet Errors, and In Cell Errors. A 'Reset' button is located below the table.

Port Number	In Octets	Out Octets	In Packets	Out Packets	In OAM Cells	Out OAM Cells	In ASM Cells	Out ASM Cells	In Packet Errors	In Cell Errors
1	14467180	1330512	11347	7340	2	4	0	0	0	0

**Port Number:** Shows number of the port for xTM.

**In Octets:** Number of received octets over the interface.

**Out Octets:** Number of transmitted octets over the interface.

**In Packets:** Number of received packets over the interface.

**Out Packets:** Number of transmitted packets over the interface.

**In OAM Cells:** Number of OAM cells received.

**Out OAM Cells:** Number of OAM cells transmitted.

**In ASM Cells:** Number of ASM cells received.

**Out ASM Cells:** Number of ASM cells transmitted.

**In Packet Errors:** Number of received packets with errors.

**In Cell Errors:** Number of received cells with errors.

**Reset:** Click to reset the statistics.

Status

▼ xDSL

xDSL		
Mode	ADSL_2plus	
Traffic Type	ATM	
Status	Up	
Link Power State	L0	
	Downstream	Upstream
Line Coding (Trellis)	On	On
SNR Margin (dB)	7.2	7.2
Attenuation (dB)	0.0	1.3
Output Power (dBm)	7.2	9.3
Attainable Rate (Kbps)	28388	1335
Rate (Kbps)	27447	1299

MSGc (# of bytes in overhead channel message)	51	27
B (# of bytes in Mux Data Frame)	244	81
M (# of Mux Data Frames in FEC Data Frame)	1	1
T (Mux Data Frames over sync bytes)	4	1
R (# of check bytes in FEC Data Frame)	0	0
S (ratio of FEC over PMD Data Frame length)	0.2853	1.9939
L (# of bits in PMD Data Frame)	6869	329
D (interleaver depth)	1	1
Delay (msec)	0.7	0.49
INP (DMT symbol)	0.0	0.0
Super Frames	0	0
Super Frame Errors	0	0
RS Words	0	3255787
RS Correctable Errors	0	0
RS Uncorrectable Errors	0	0
HEC Errors	0	0
OCD Errors	0	0
LCD Errors	0	0
Total Cells	246668876	11669357
Data Cells	174531	18211
Bit Errors	0	0
Total ES	0	0
Total SES	0	0
Total UAS	25	25

**Mode:** Modulation protocol, including G.dmt, G.lite, T1.413, ADSL2, AnnexL, ADSL2+ and AnnexM.

**Traffic Type:** Transfer mode, here supports ATM and PTM.

**Status:** Show the status of DSL link.

**Link Power State:** Show link output power state.

**Line Coding (Trellis):** Trellis on/off.

**SNR Margin (dB):** Show the Signal to Noise Ratio (SNR) margin.

**Attenuation (dB):** This is estimate of average loop attenuation of signal.

**Output Power (dBm):** Show the output power.

**Attainable Rate (Kbps):** The sync rate you would obtain.

**Rate (Kbps):** Show the downstream and upstream rate in Kbps.

**MSGc (#of bytes in overhead channel message):** The number of bytes in overhead channel message.

**B (# of bytes in Mux Data Frame):** The number of bytes in Mux Data frame.

**M (# of Mux Data Frames in FEC Data Frame):** The number of Mux Data frames in FEC frame.

**T (Mux Data Frames over sync bytes):** The number of Mux Data frames over all the sync bytes.

**R (# of check bytes in FEC Data Frame):** The number of check bytes in FEC frame.

**S (ratio of FEC over PMD Data Frame length):** The ratio of FEC over PMD Data frame length

**L (# of bits in PMD Data Frame):** The number of bit in PMD Data frame

**D (interleaver depth):** Show the interleaver depth.

**Delay (msec):** Show the delay time in msec.

**INP (DMT symbol):** Show the DMT symbol.

**Super Frames:** The total number of super frames.

**Super Frame Errors:** The total number of super frame errors.

**RS Words:** Total number of Reed-Solomon code errors.

**RS Correctable Errors:** Total number of RS with correctable errors.

**RS Uncorrectable Errors:** Total number of RS words with uncorrectable errors.

**HEC Errors:** Total number of Header Error Checksum errors.

**OCD Errors:** Total number of out-of-cell Delineation errors.

**LCD Errors:** Total number of Loss of Cell Delineation.

**Total Cells:** Total number of cells.

**Data Cells:** Total number of data cells.

**Bit Errors:** Total number of bit errors.

**Total ES:** Total Number of Errored Seconds.

**Total SES:** Total Number of Severely Errored Seconds.

**Total UAS:** Total Number of Unavailable Seconds.

**xDSL BER Test:** Click this button to start a bit Error Rate Test. The ADSL Bit Error Rate (BER) test determines the quality of the ADSL connection. The test is done by transferring idle cells containing a known pattern and comparing the received data with this known pattern to check for any errors.

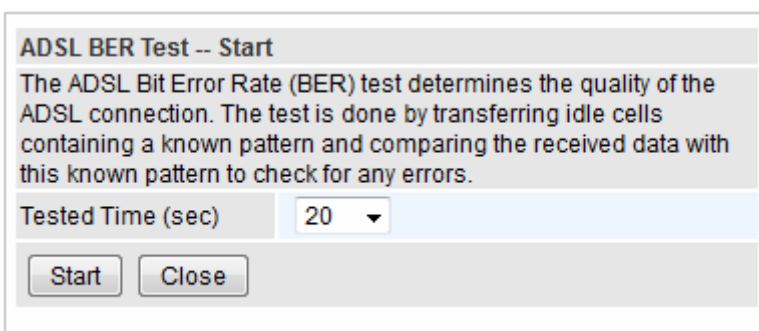

Select the Tested Time (sec), press **Start** to start test.

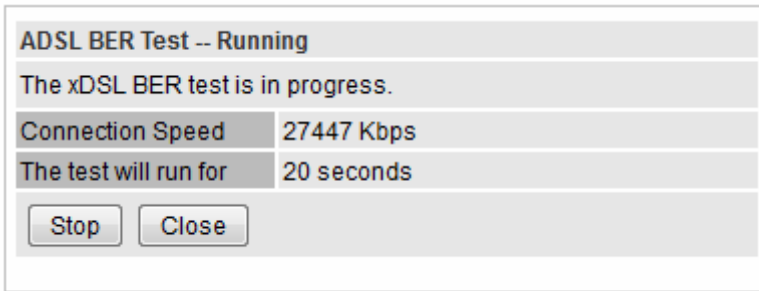

When it is OK, the following test result window will appear. You can view the quality of ADSL connection. Here the connection is OK.

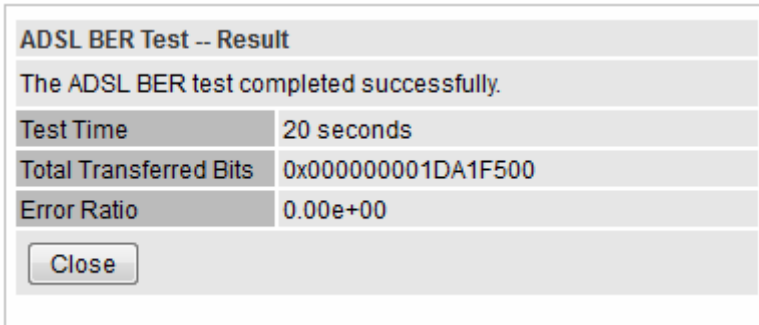

**Reset:** Click this button to reset the statistics.



## Bandwidth Usage

Bandwidth Usage provides users direct view of bandwidth usage with simple diagram. Bandwidth usage shows the use of the bandwidth from two angles: Transmitted and Received, giving users a clear idea of the usage.

### LAN

**Note:** P4 can be configured as EWAN, and when the device is in EWAN profile, there is no P4/EWAN interface as P4 is working as a WAN port.

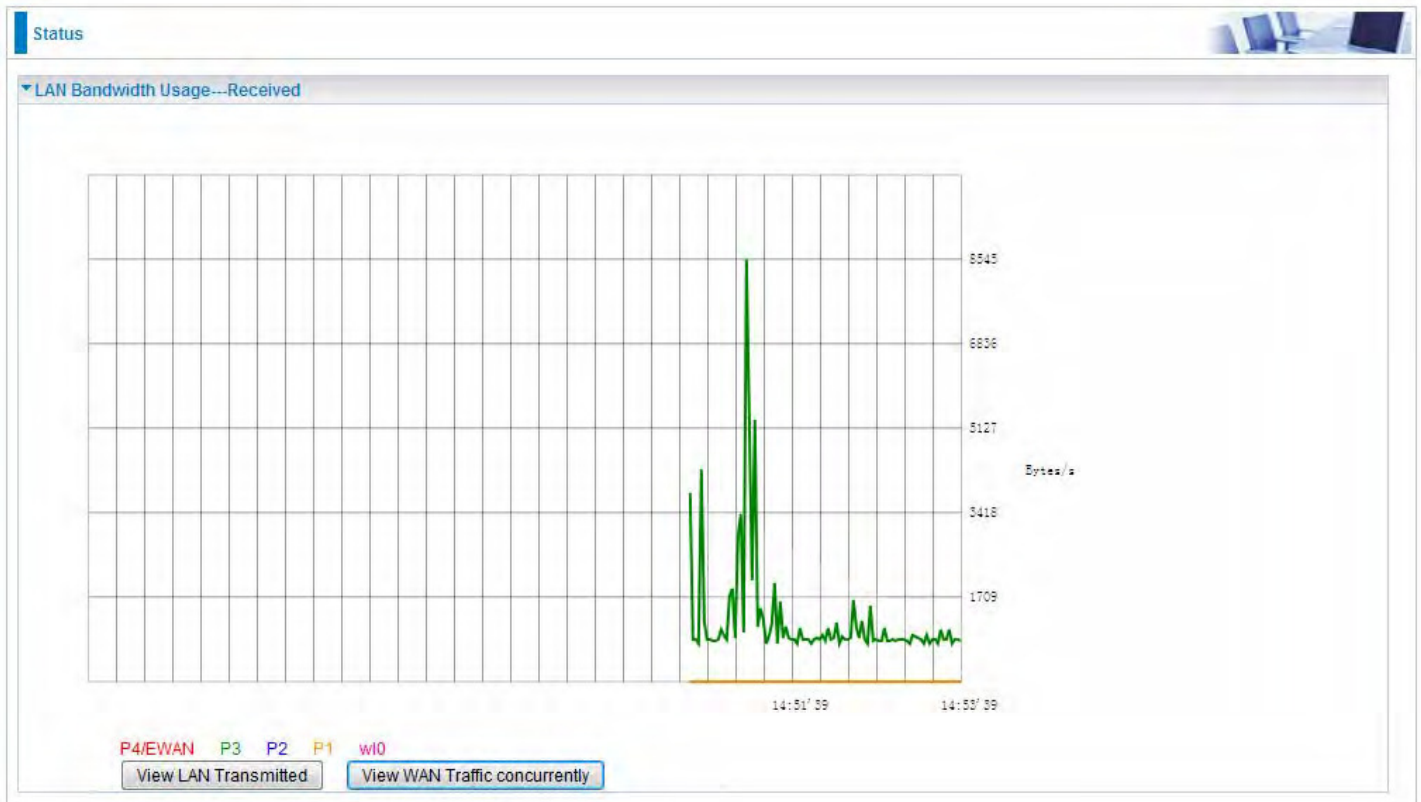

(DSL)

Press **View LAN Transmitted** button to change the diagram to the statistics from a Received Bytes of view. (**Note:** P3 means Ethernet port #3, and the traffic information of the port #3 is identified with green, the same color with P3 in the diagram; other ports all take the same mechanism.)

When you press **View WAN Traffic concurrently** button, the WAN Bandwidth Usage pops up so that users can view the WAN traffic concurrently.

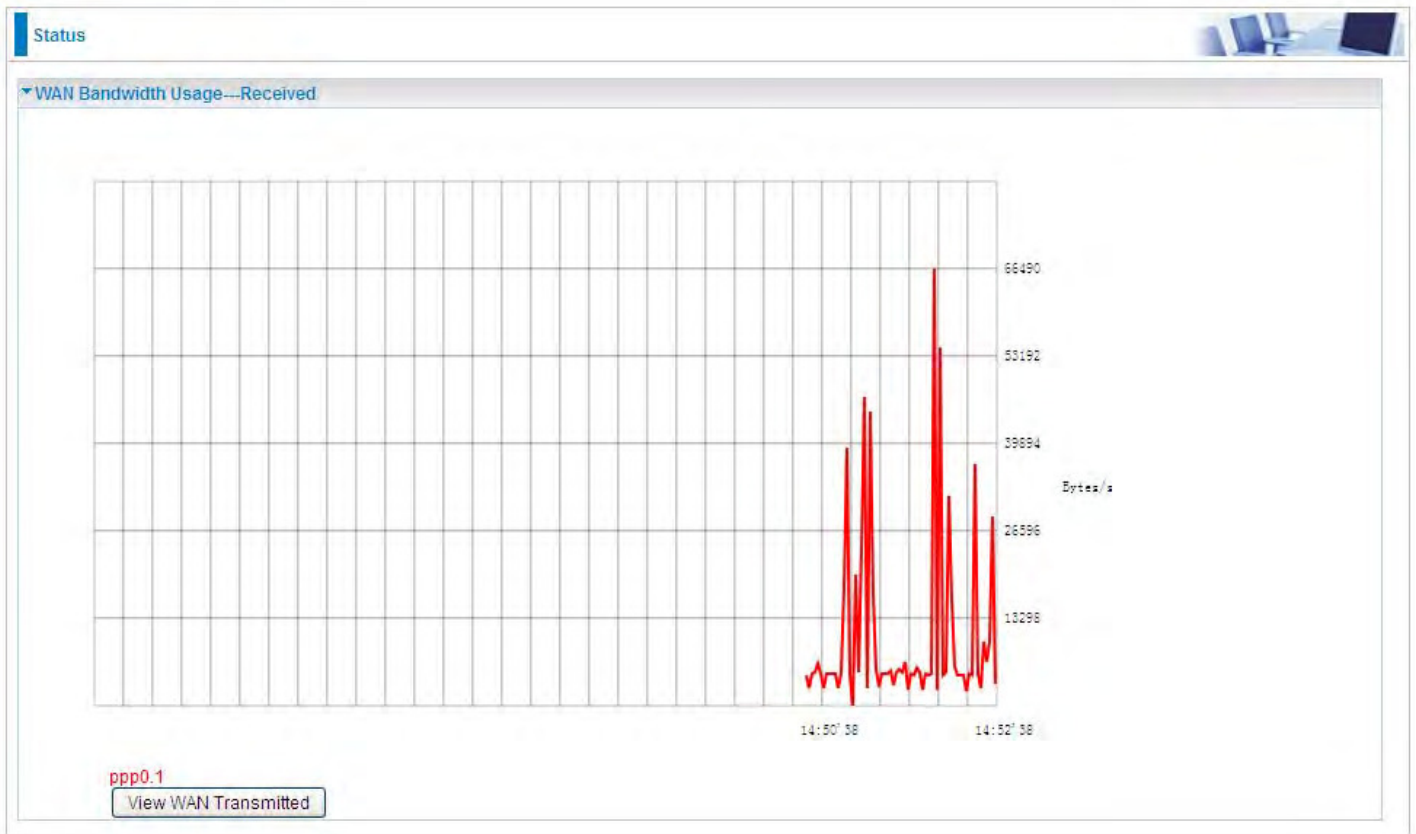

## WAN Service

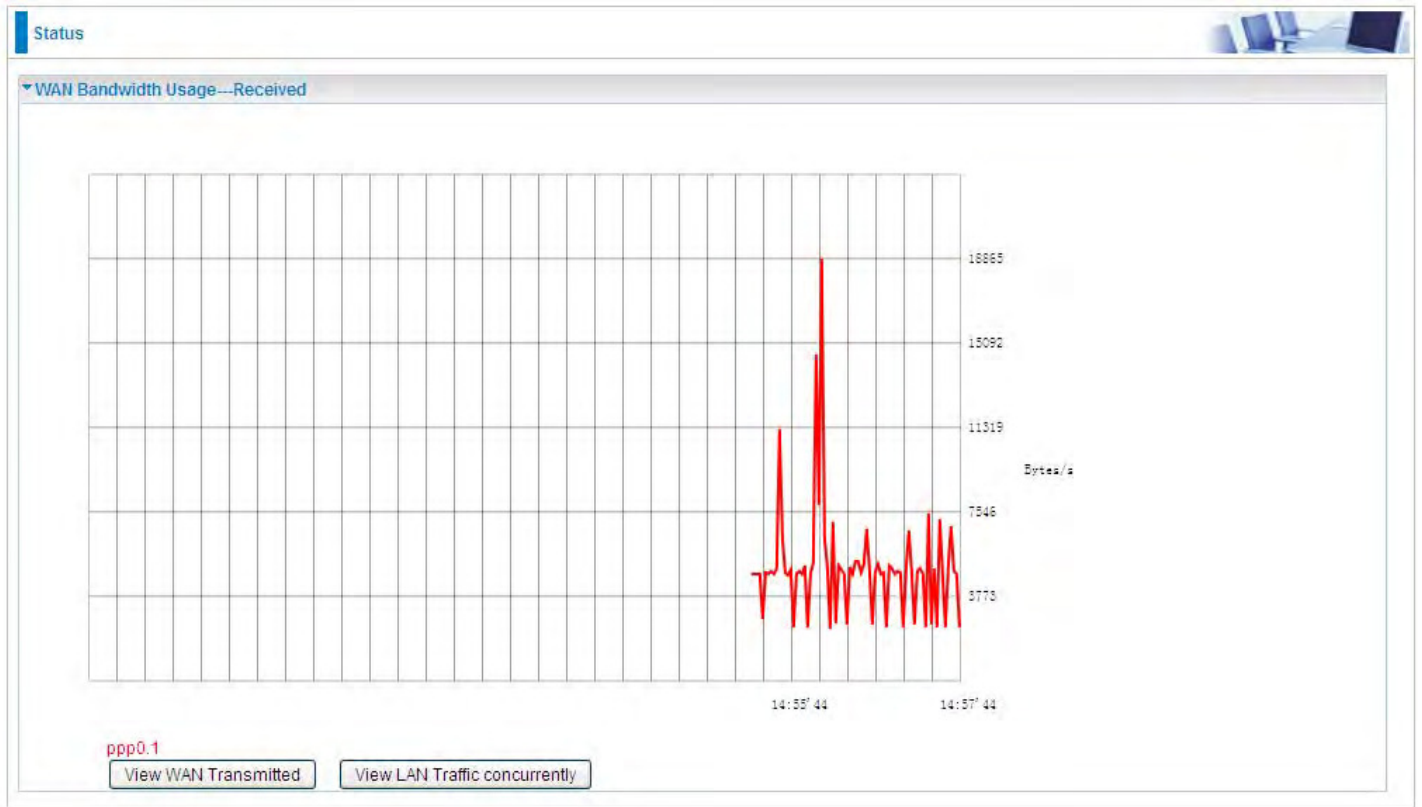

Press **View WAN Transmitted** button to change the diagram to the statistics from a Received Bytes of view.

Press **View LAN Traffic concurrently** button to directly switch to the LAN Bandwidth Usage page to view the LAN traffic concurrently.

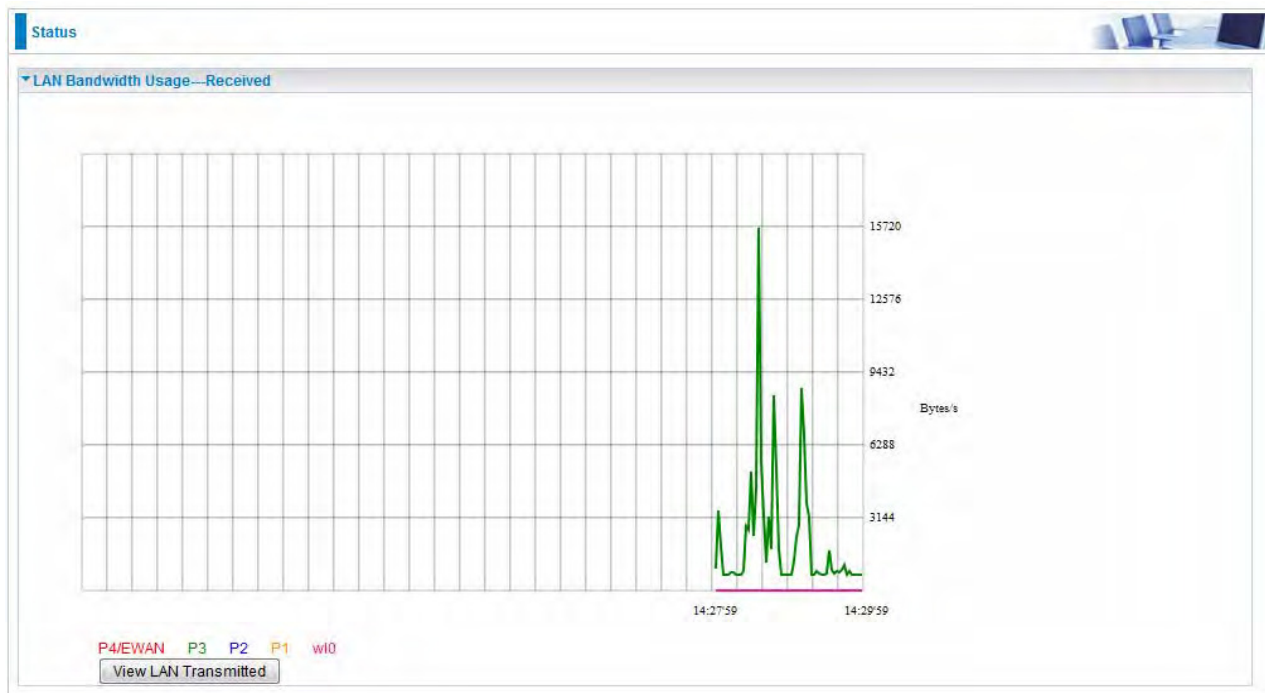

## 3G/LTE Status



Parameters	
Current SIM	SIM 1
Status	Up
Signal Strength	
Network Name	N/A
Network Mode	UMTS
Card Name	<del>XXXXXXXXXXXX</del>
Card Firmware	<del>XXXXXXXXXXXX</del>
Current TX Bytes / Packets	65.5K / 1K
Current RX Bytes / Packets	1.7M / 1.3K
Total TX Bytes / Packets	0.2M / 4.4K
Total RX Bytes / Packets	10.7M / 8K
Total Connection Time	00:14:55

**Current SIM:** The current SIM in use.

**Status:** The current status of the 3G/LTE card.

**Signal Strength:** The signal strength bar indicates current 3G/LTE signal strength.

**Network Name:** The network name that the device is connected to.

**Network Mode:** The current operation mode for 3G/LTE card, it depends on service provider and card's limitation, GSM or UMTS.

**Card Name:** The name of the 3G/LTE card.

**Card Firmware:** The current firmware for the 3G/LTE card.

**Current TX Bytes / Packets:** The statistics of transmitted Bytes / Packets, count for this call.

**Current RX Bytes / Packets:** The statistics of received Bytes / Packets, count for this call.

**Total TX Bytes / Packets:** The statistics of transmitted Bytes / Packets, count since 3G/LTE connection is ready.

**Total RX Bytes / Packets:** The statistics of received Bytes / Packets, count since 3G/LTE connection is ready.

**Total Connection Time:** The statistics of the connection time since 3G/LTE connection is ready.

# Route

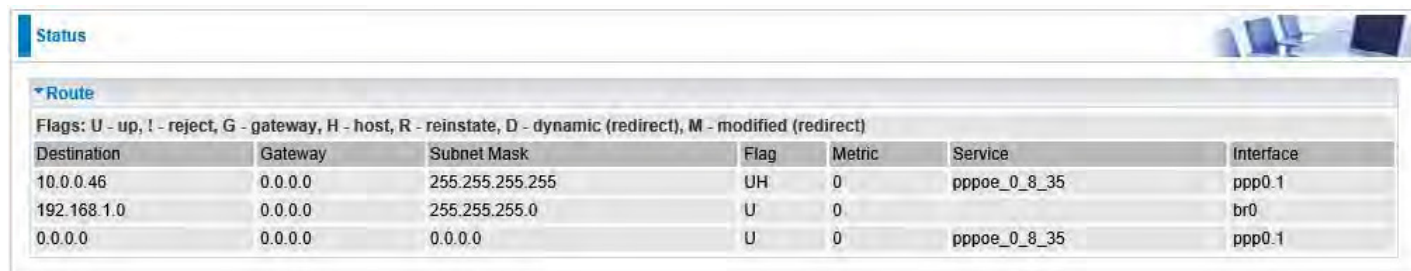

Status

Route

Flags: U - up, ! - reject, G - gateway, H - host, R - reinstate, D - dynamic (redirect), M - modified (redirect)

Destination	Gateway	Subnet Mask	Flag	Metric	Service	Interface
10.0.0.46	0.0.0.0	255.255.255.255	UH	0	pppoe_0_8_35	ppp0.1
192.168.1.0	0.0.0.0	255.255.255.0	U	0		br0
0.0.0.0	0.0.0.0	0.0.0.0	U	0	pppoe_0_8_35	ppp0.1

**Destination:** The IP address of destination network.

**Gateway:** The IP address of the gateway this route uses.

**Subnet Mask:** The destination subnet mask.

**Flag:** Show the status of the route.

- ① **U:** Show the route is activated or enabled.
- ① **H (host):** destination is host not the subnet.
- ① **G:** Show that the outside gateway is needed to forward packets in this route.
- ① **R:** Show that the route is reinstated from dynamic routing.
- ① **D:** Show that the route is dynamically installed by daemon or redirecting.
- ① **M:** Show the route is modified from routing daemon or redirect.

**Metric:** Display the number of hops counted as the Metric of the route.

**Service:** Display the service that this route uses.

**Interface:** Display the existing interface this route uses.

# ARP

This section displays the router's ARP (Address Resolution Protocol) Table, which shows the mapping of Internet (IP) addresses to Ethernet (MAC) addresses. This is useful as a quick way of determining the MAC address of the network interface of your PCs to use with the router's **Security – MAC Filtering** function. Here IPv6 Neighbor Table, listed with IPv6 address-MAC mapping, is supported.

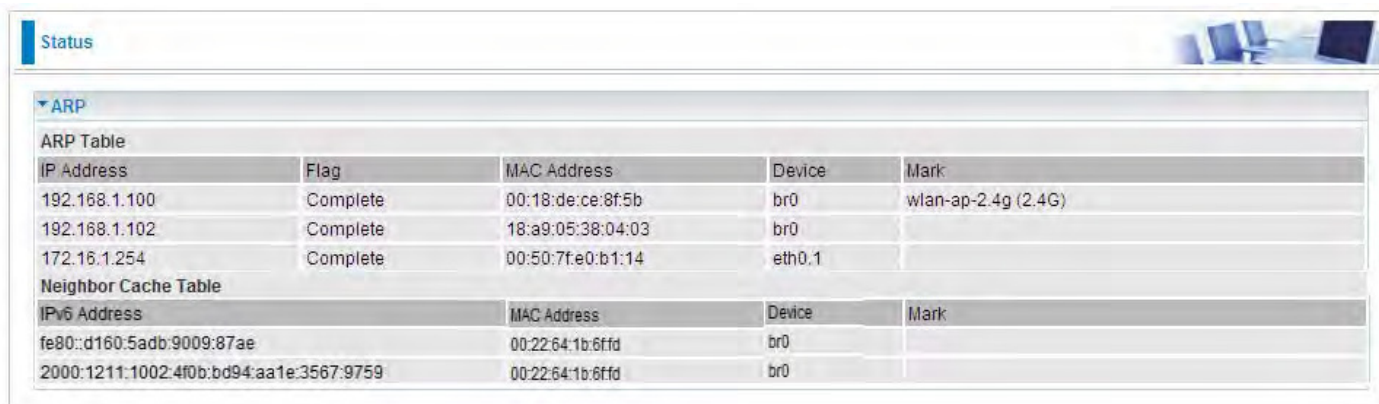

The screenshot shows a web interface with a 'Status' tab. Underneath, there is a section for 'ARP' which contains two tables. The first table is the 'ARP Table' and the second is the 'Neighbor Cache Table'.

IP Address	Flag	MAC Address	Device	Mark
192.168.1.100	Complete	00:18:de:ce:8f:5b	br0	wlan-ap-2.4g (2.4G)
192.168.1.102	Complete	18:a9:05:38:04:03	br0	
172.16.1.254	Complete	00:50:7f:e0:b1:14	eth0.1	

IPv6 Address	MAC Address	Device	Mark
fe80::d160:5adb:9009:87ae	00:22:64:1b:6ffd	br0	
2000:1211:1002:4f0b:bd94:aa1e:3567:9759	00:22:64:1b:6ffd	br0	

## ARP table

**IP Address:** Shows the IP Address of the device that the MAC address maps to.

**Flag:** Shows the current status of the ARP entries.

- ① Complete: the route resolving is processing well.
- ① M(Marked as permanent entry): the route is permanent.
- ① P (publish entry): publish this route item.

**MAC Address:** Shows the MAC address that is corresponded to the IP address of the device it is mapped to.

**Device:** here refers to the physical interface, it is a concept to identify Clients from LAN or WAN. For example, the Clients in LAN, here displays “br0”.

**Mark:** Show clearly the SSID (WLAN) the device is in.

## Neighbor Cache Table

**IPv6 address:** Shows the IPv6 Address of the device that the MAC address maps to.

**MAC Address:** Shows the MAC address that is corresponded to the IPv6 address of the device it is mapped to.

**Device:** here refers to the physical interface, it is a concept to identify Clients from LAN or WAN. For example, the Clients in LAN, here displays “br0”.

**Mark:** Show clearly the SSID (WLAN) the device is in.

# DHCP

The DHCP Table lists the DHCP lease information for all IP addresses assigned by the DHCP server in the device.



The screenshot shows a web-based interface with a 'Status' tab selected. Underneath, there is a 'DHCP' section containing a 'Leased Table'. The table has five columns: Host Name, MAC Address, IP Address, Expires In, and Mark. Two rows of data are visible.

Host Name	MAC Address	IP Address	Expires In	Mark
billion-17bc6f1	18:a9:05:38:04:03	192.168.1.100	18 hours, 47 minutes, 19 seconds	
ytt-PC	00:18:de:ce:8f:5b	192.168.1.101	23 hours, 59 minutes, 11 seconds	wlan-ap-2.4g

**Host Name:** The Host Name of DHCP client.

**MAC Address:** The MAC Address of DHCP client host.

**IP Address:** The IP address which is assigned to the host with this MAC address.

**Expires in:** The remaining time of the IP being available for this host.

**Mark:** Show clearly the SSID (WLAN) the device is in.



# VPN

VPN status viewing section provides users IPsec, PPTP, L2TP and GRE VPN status.

## IPSec



The screenshot shows a web interface for VPN status. At the top left, there is a 'Status' tab. Below it, the 'IPSec Status' section is expanded, showing a table of VPN tunnels. The table has columns for Name, Active, Local Subnet, Remote Subnet, Remote Gateway, and SA. One tunnel named '11' is listed with an 'Active' status of 'X' (inactive). Below the table is a 'Refresh' button.

Name	Active	Local Subnet	Remote Subnet	Remote Gateway	SA
11	X	192.168.1.0 -- 255.255.255.0	192.168.0.0 -- 255.255.255.0	172.16.1.235	

**Name:** The IPsec connection name.

**Active:** Display the connection status.

**Local Subnet:** Display the local network.

**Remote Subnet:** Display the remote network.

**Remote Gateway:** The remote gateway address.

**SA:** The Security Association for this IPsec entry.

**Refresh:** Click this button to refresh the tunnel status.

## PPTP

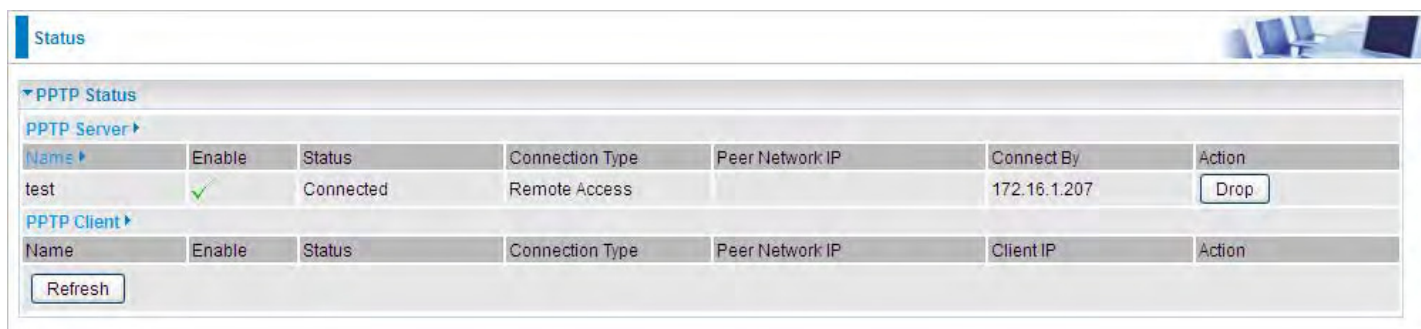

PPTP Status						
PPTP Server						
Name	Enable	Status	Connection Type	Peer Network IP	Connect By	Action
test	<input checked="" type="checkbox"/>	Connected	Remote Access		172.16.1.207	Drop

PPTP Client						
Name	Enable	Status	Connection Type	Peer Network IP	Client IP	Action
<input type="button" value="Refresh"/>						

### PPTP Server

**Name:** The PPTP connection name.

**Enable:** Display the connection status with icon.

**Status:** The connection status.

**Connection Type:** Remote Access or LAN to LAN.

**Peer Network IP:** Display the remote (client side) network and subnet mask in LAN to LAN PPTP connection.

**Connected By:** Display the IP of remotely connected client.

**Action:** Act to the connection. Click Drop button to disconnect the tunnel connection.

### PPTP Client

**Name:** The PPTP connection name.

**Enable:** Display the connection status with icon.

**Status:** The connection status.

**Connection Type:** Remote Access or LAN to LAN.

**Peer Network IP:** Display the remote (server side) network and subnet mask.

**Client:** Assigned IP by PPTP server.

**Action:** Act to the connection. Click Disconnect button to disconnect the tunnel connection.

**Refresh:** Click this button to refresh the connection status.

## L2TP



The screenshot shows a web interface titled "Status" with a sub-section "L2TP Status". It contains two tables: "L2TP Server" and "L2TP Client". The "L2TP Server" table has one entry named "test1" which is enabled and connected. The "L2TP Client" table is currently empty. A "Refresh" button is located below the "L2TP Client" table.

L2TP Status						
L2TP Server						
Name	Enable	Status	Connection Type	Peer Network IP	Connect By	Action
test1	<input checked="" type="checkbox"/>	Connected	Remote Access		192.168.1.10	<input type="button" value="Drop"/>

L2TP Client						
Name	Enable	Status	Connection Type	Peer Network IP	Client IP	Action

### L2TP Server

**Name:** The L2TP connection name.

**Enable:** Display the connection status with icon.

**Status:** The connection status.

**Connection Type:** Remote Access or LAN to LAN.

**Peer Network IP:** Display the remote (client side) network and subnet mask in LAN to LAN L2TP connection.

**Connected By:** Display the IP of remotely connected client.

**Action:** Act to the connection. Click Drop button to disconnect the tunnel connection.

### L2TP Client

**Name:** The L2TP connection name.

**Enable:** Display the connection status with icon.

**Status:** The connection status.

**Connection Type:** Remote Access or LAN to LAN.

**Peer Network IP:** Display the network and subnet mask of server side.

**Client:** Assigned IP by L2TP server.

**Action:** Act to the connection. Click Disconnect button to disconnect the tunnel connection.

**Refresh:** Click this button to refresh the connection status.

## OpenVPN

The top screenshot shows the OpenVPN status interface with the following data:

OpenVPN Status							
OpenVPN Server							
Name	Enable	Status	Connection Type	Peer Network IP	Server IP	Connect By	Action
test1	✓	Connected	Remote Access		192.168.15.1	192.168.15.22	Drop

The bottom screenshot shows the OpenVPN status interface with the following data:

OpenVPN Status					
OpenVPN Server					
Name	Enable	Status	Peer Network IP	Client IP	Action
test1	✓	Connected	192.168.15.1 (192.168.200.131)	192.168.15.22	Disconnect

### OpenVPN Server

**Name:** The OpenVPN connection name.

**Enable:** Display the connection status with icon.

**Status:** The connection status.

**Connection Type:** Remote Access or LAN to LAN.

**Peer Network IP:** Display the subnet address of client side in LAN to LAN mode.

**Server IP:** The tunnel virtual IP of server side assigned by server itself.

**Connected By:** The assigned tunnel virtual IP to remotely connected OpenVPN client.

**Action:** Act to the connection. Click Drop button to disconnect the tunnel connection.

### OpenVPN Client

**Name:** The OpenVPN connection name.

**Enable:** Display the connection status with icon.

**Status:** The connection status.

**Connection Type:** Remote Access or LAN to LAN.

**Peer Network IP:** Display the tunnel virtual address (WAN address) of server side.

**Client:** Assigned tunnel virtual IP by OpenVPN server.

**Action:** Act to the connection. Click Disconnect button to disconnect the tunnel connection.

**Refresh:** Click this button to refresh the connection status.

## GRE



Name	Enable	Status	Remote Gateway IP
test3	✓	Connected	69.121.1.22

Refresh

**Name:** The GRE connection name.

**Enable:** Display the connection status with icons.

**Status:** The connection status, connected or disable.

**Remote Gateway:** The IP of remote gateway.

**Refresh:** Click this button to refresh the connection status.

# Log

## System Log

Display system logs accumulated up to the present time. You can trace historical information with this function. And the log policy can be configured in [Configure Log](#) section.

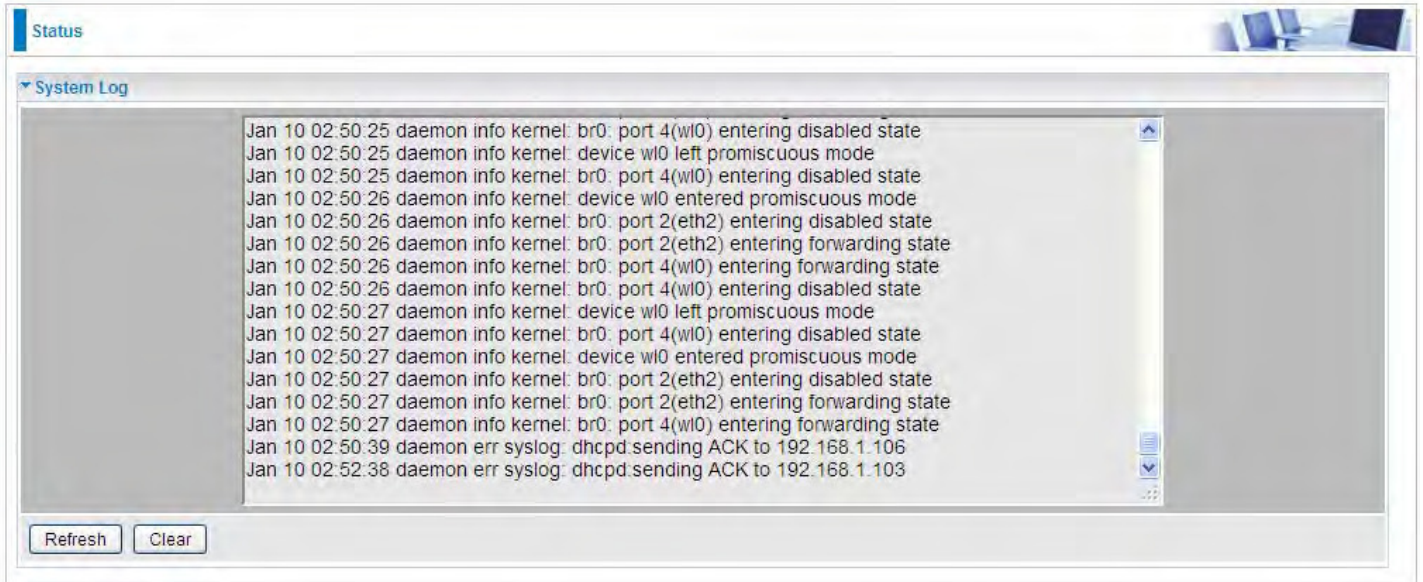

**Refresh:** Click to update the system log.

**Clear:** Click to clear the current log from the screen.

## Security Log

Security log displays the message logged about security, like filter messages and some firewall message. You can turn to [IP Filtering Outgoing](#), [IP Filtering Incoming](#), [URL Filter](#) to determine if you want to log this information. Also you can turn to Configure Log section below to determine the level to log the message. You can use this to track potential threats to your system and network.

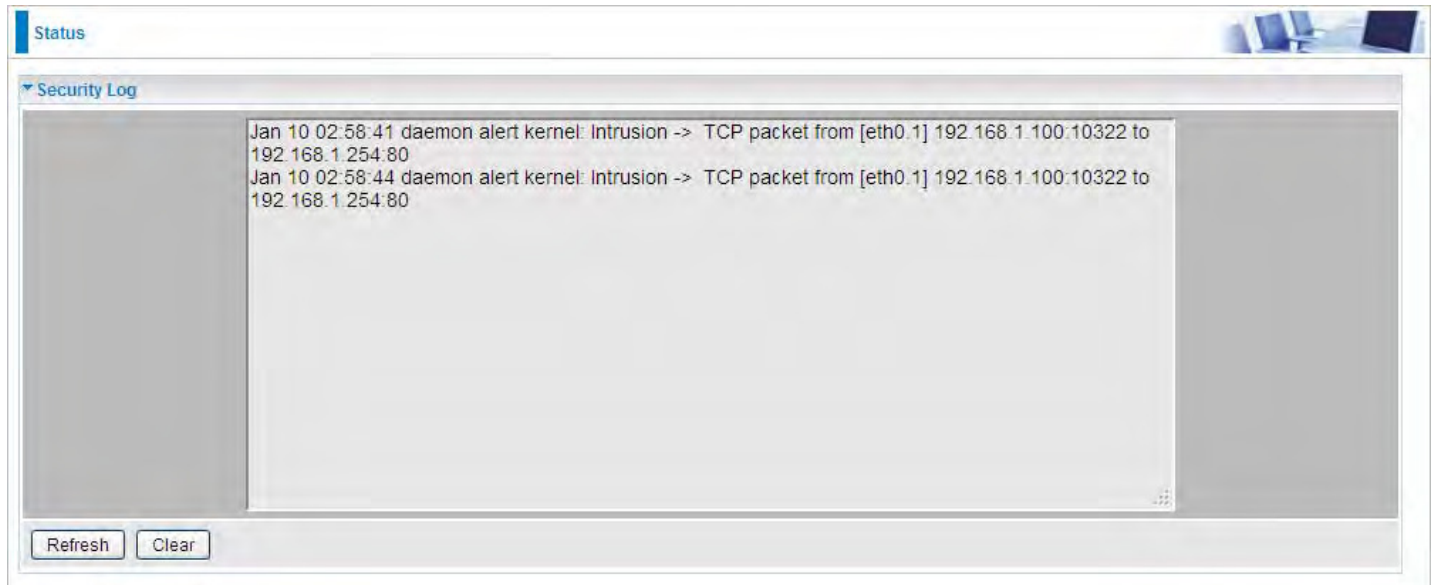

**Refresh:** Click to update the system log.

**Clear:** Click to clear the current log from the screen.

# VRRP Status

Status 

▼ VRRP Status

Current Status	
Current Master	

**Current Status:** Show VRRP current status, Master or Backup.

**Current Master:** Show the IP address of current master.



# Quick Start

## Quick Start

This part allows you to quickly configure and connect your router to internet.

### DSL mode

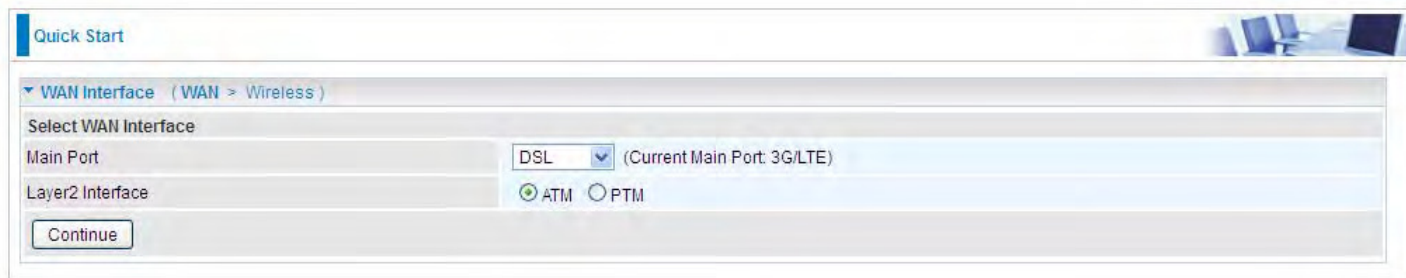

Quick Start

WAN Interface (WAN > Wireless)

Select WAN Interface

Main Port: DSL (Current Main Port: 3G/LTE)

Layer2 Interface:  ATM  PTM

Continue

1. Select DSL, press **Continue** to go on to next step.
2. Enter the username, password from your ISP, for IP and DNS settings; also refer to your ISP. Here IPv6 service is enabled by default.

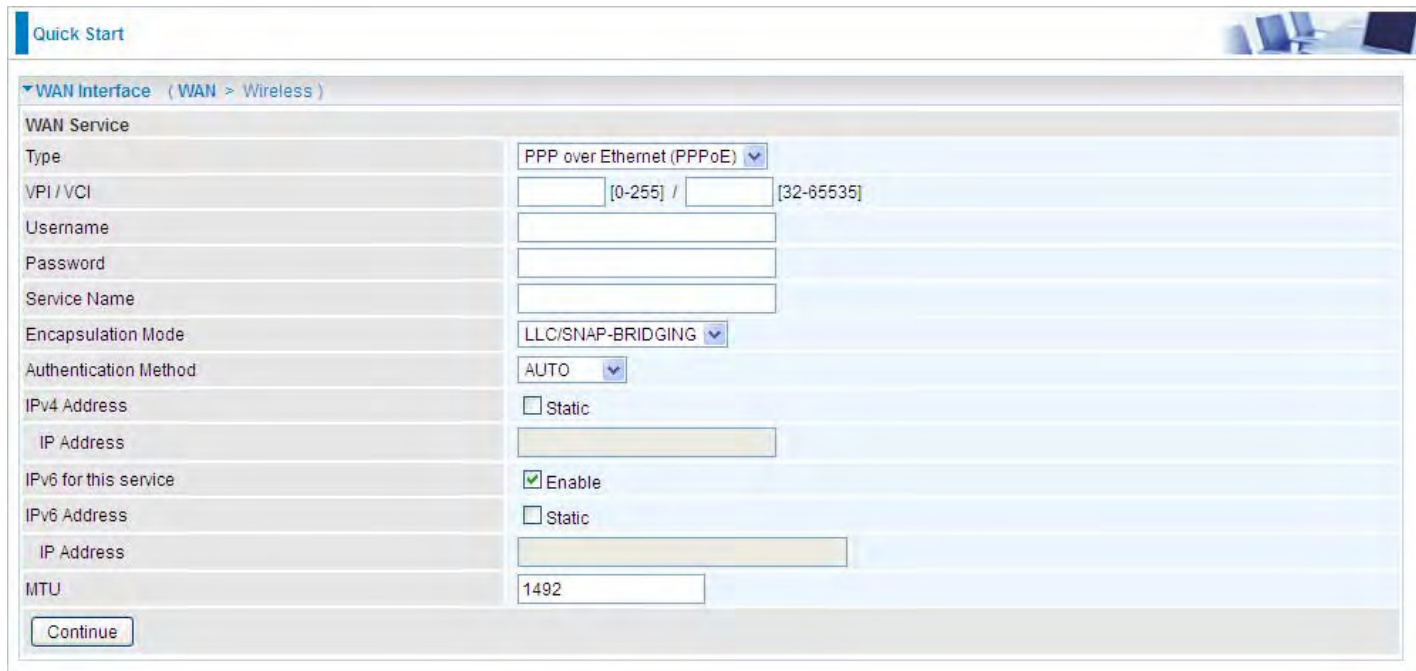

Quick Start

WAN Interface (WAN > Wireless)

WAN Service

Type: PPP over Ethernet (PPPoE)

VPI / VCI: [0-255] / [32-65535]

Username: [ ]

Password: [ ]

Service Name: [ ]

Encapsulation Mode: LLC/SNAP-BRIDGING

Authentication Method: AUTO

IPv4 Address:  Static

IP Address: [ ]

IPv6 for this service:  Enable

IPv6 Address:  Static

IP Address: [ ]

MTU: 1492

Continue

If the DLS line is not synchronized, the page will pop up warning of the DSL connection failure.



Quick Start

WAN Interface (WAN > Wireless)

DSL Line Is Not Ready. Please Check your DSL Line and wait for a while.

### 3. Wait while the device is configured.



### 4. WAN port configuration is successful.

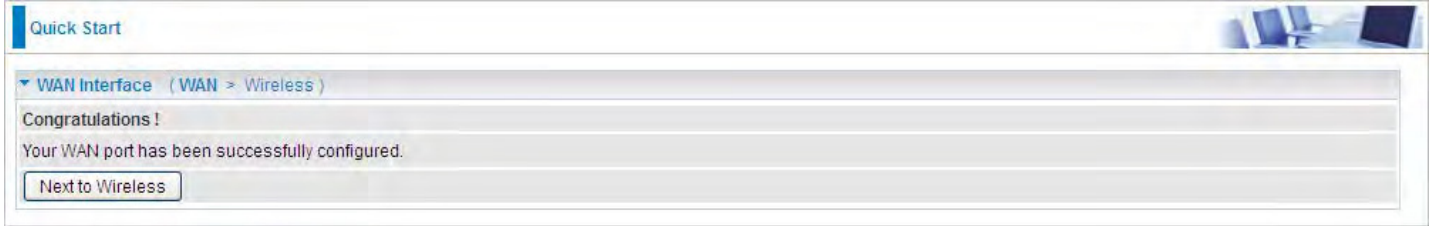

### 5. After the configuration is successful, click **Next to Wireless** button and you may proceed to configure the Wireless setting. Enable wireless and set the SSID and encryption Key (1. Leave it empty to disable the wireless security; 2. Fill in the Key, and the encryption mode will be WPA2-PSK/AES).



### 6. Success.



If Quick Start is finished, user can turn to Status > Summary to see the basic information.

**Status** 

**▼ Device Information**

Model Name	BiPAC 7820NZ
Host Name	home.gateway
System Up-Time	0D 19H 44M 28S
Date/Time	Tue Mar 31 03:03:39 2015 <input type="button" value="Sync"/>
Software Version	2.32e
LAN IPv4 Address	192.168.1.254
LAN IPv6 Address	2000:1211:1000:4d0b:204:edff:fe01:1/64
MAC Address	00:04:ed:01:00:01
DSL PHY and Driver Version	A2pD038f.d24h
Wireless Driver Version	6.30.102.7.cpe4.12L08.4

**▼ WAN**

Line Rate - Upstream (Kbps)	1291
Line Rate - Downstream (Kbps)	26919
Default Gateway / IPv4 Address	ppp0.1 (DSL) / 10.40.90.211
Connection Time	00:02:44
Primary DNS Server	218.2.135.1
Secondary DNS Server	218.2.135.1
Default IPv6 Gateway / IPv6 Address	ppp0.1 (DSL) / 2000:db98:1000:1000:29ac:afc6:59a4:5816/64

## Ethernet mode

1. Select **Ethernet**, press **Continue** to go on to next step.



Quick Start

WAN Interface (WAN > Wireless)

Select WAN Interface

Main Port: Ethernet (Current Main Port: 3G/LTE)

Continue

2. Enter the username, password from your ISP, for IP and DNS settings; also refer to your ISP. Here IPv6 service is enabled by default.

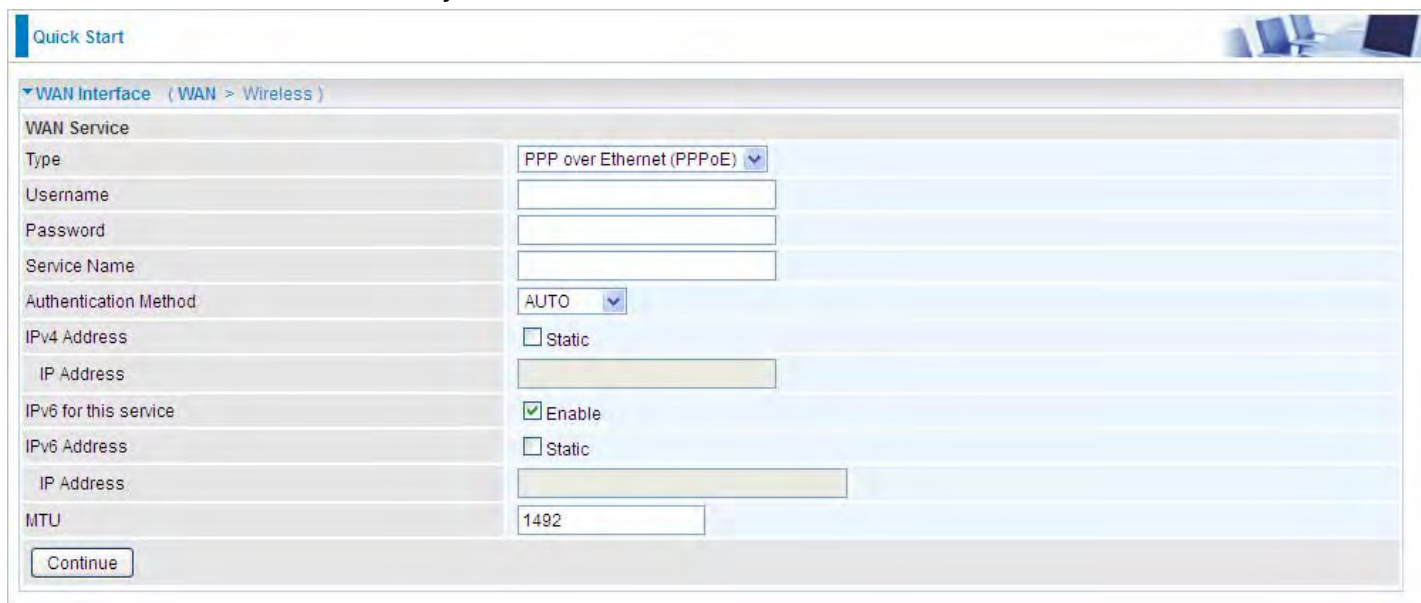

Quick Start

WAN Interface (WAN > Wireless)

WAN Service

Type: PPP over Ethernet (PPPoE)

Username: [text input]

Password: [text input]

Service Name: [text input]

Authentication Method: AUTO

IPv4 Address:  Static

IP Address: [text input]

IPv6 for this service:  Enable

IPv6 Address:  Static

IP Address: [text input]

MTU: 1492

Continue

3. Wait while the device is configured.



Quick Start

WAN Interface (WAN > Wireless)

Please wait while the device is configured.

4. WAN port configuration is successful.



Quick Start

WAN Interface (WAN > Wireless)

Congratulations!

Your WAN port has been successfully configured.

Next to Wireless

5. After the configuration is successful, click **Next to Wireless** button and you may proceed to configure the Wireless setting. Enable wireless and set the SSID and encryption Key (1. Leave it empty to disable the wireless security; 2. Fill in the Key, and the encryption mode will be WPA2-PSK/AES).

Quick Start

Wireless (WAN > Wireless)

Parameters

Wireless	<input checked="" type="checkbox"/> Enable
SSID	<input type="text" value="wlan-ap-2.4g"/>
WPA2 Pre-Shared Key	<input type="text"/> <a href="#">Click here to display</a>

Quick Start

Wireless (WAN > Wireless)

Please wait while the device is configured.

6. Success.

Quick Start

Process finished

Success.

## 3G/LTE

1. Select **3G/LTE**, press **Continue** to go on to next step.



Quick Start

WAN Interface (WAN > Wireless)

Select WAN Interface

Main Port: 3G/LTE (Current Main Port: Ethernet)

Username:

APN: internet

Continue

2. Select the 3G/LTE mode, and enter the APN, username, password from your ISP; and check with your ISP with the authentication method setting for each SIM (SIM1 and SIM2).

**Note:** Given that BiPAC 7820NZ supports dual -SIM mobile connectivity, please determine which SIM you are gonna use or both (3G/LTE failover), and set the exact required connecting information for each SIM (SIM1 and SIM2).

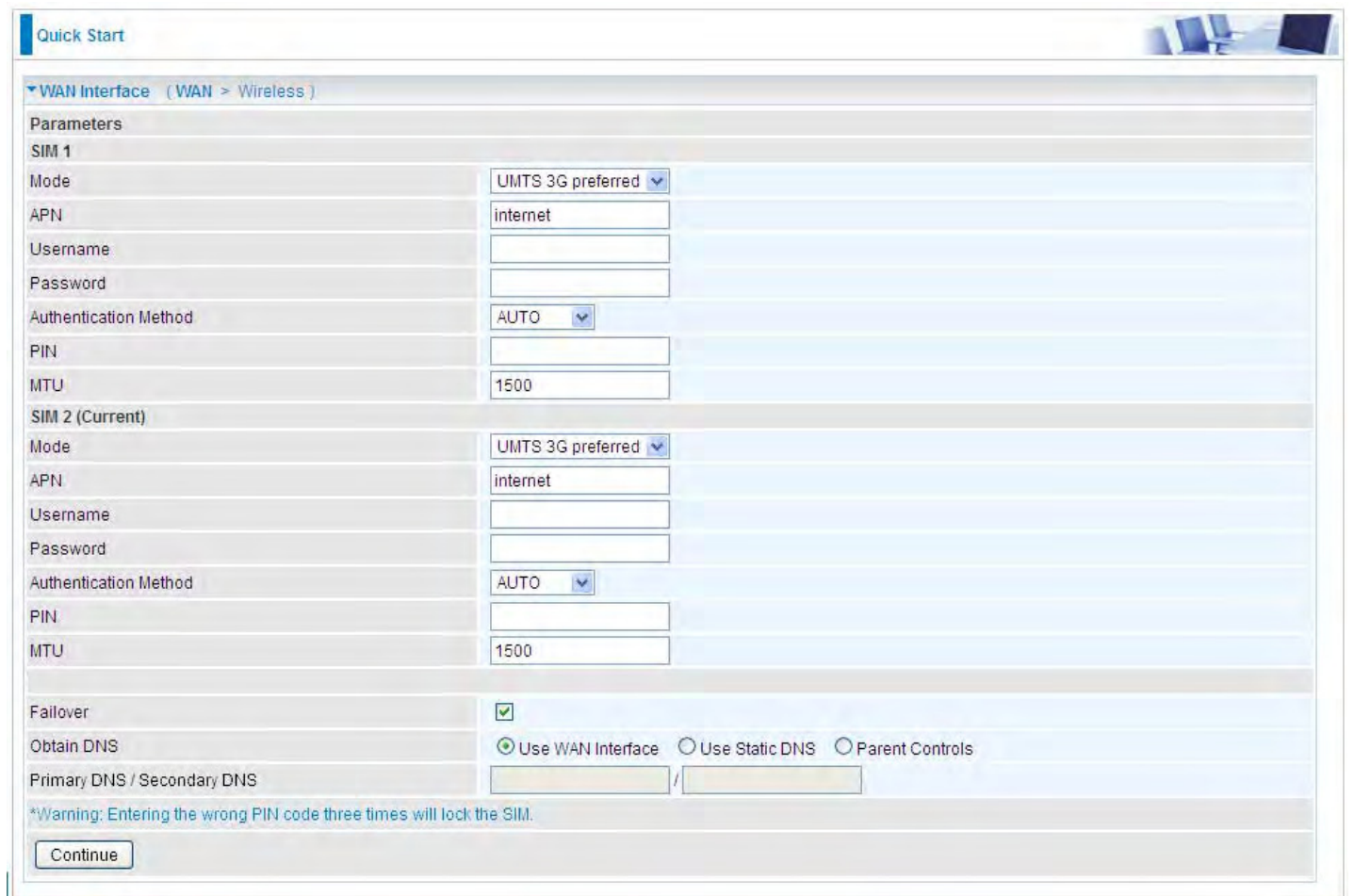

Quick Start

WAN Interface (WAN > Wireless)

Parameters

SIM 1

Mode: UMTS 3G preferred

APN: internet

Username:

Password:

Authentication Method: AUTO

PIN:

MTU: 1500

SIM 2 (Current)

Mode: UMTS 3G preferred

APN: internet

Username:

Password:

Authentication Method: AUTO

PIN:

MTU: 1500

Failover:

Obtain DNS:  Use WAN Interface  Use Static DNS  Parent Controls

Primary DNS / Secondary DNS: /

\*Warning: Entering the wrong PIN code three times will lock the SIM.

Continue

3. Wait while the device is configured.



Quick Start

WAN Interface (WAN > Wireless)

Please wait while the device is configured.

#### 4. WAN port configuration is successful.



5. After the configuration is successful, click **Next to Wireless** button and you may proceed to configure the Wireless setting. Enable wireless and set the SSID and encryption Key (1. Leave it empty to disable the wireless security; 2. Fill in the Key, and the encryption mode will be WPA2-PSK/AES).



#### 6. Success.



# Configuration

When you click this item, the column will expand to display the sub-items that will allow you to further configure your router.

**LAN, Wireless, WAN, System, USB, IP Tunnel, Security, Quality of Service, NAT** and **Wake On LAN**.

▶ Status
• Quick Start
▼ Configuration
▶ LAN
▶ Wireless
▶ WAN
▶ System
▶ USB
▶ IP Tunnel
▶ Security
▶ Quality of Service
▶ NAT
• Wake On LAN
▶ VPN
▶ Advanced Setup

The function of each configuration sub-item is described in the following sections.



# LAN - Local Area Network

A Local Area Network (LAN) is a shared communication system network where many computers are connected. This type of network is area defined and is usually limited to a confined region within a building.

## Ethernet

The screenshot shows a configuration window titled "Configuration" with a sub-section for "LAN". The "Parameters" section includes fields for Group Name (Default), IP Address (192.168.1.254), Subnet Mask (255.255.255.0), IGMP Snooping (checked), IGMP Snooping Mode (Blocking Mode selected), LAN side firewall (unchecked), and DHCP Server (Enabled). The DHCP Server section includes Start IP Address (192.168.1.100), End IP Address (192.168.1.199), Leased Time (24), Option 66 (unchecked), and Use Router's setting as DNS Server (checked). The Static IP Lease List section has a table with columns for Host Label, MAC Address, IP Address, Remove, and Edit, and an Add button. The IP Alias section includes IP Alias (unchecked), IP Address, and Subnet Mask fields. At the bottom are Apply and Cancel buttons.

### Parameters

**Group Name:** This refers to the group you set in **Interface Grouping** section; you can set the parameters for the specific group. Select the group via the drop-down box. For more information please refer to [Interface Grouping](#) of this manual.

**IP address:** the IP address of the router. Default is 192.168.1.254.

**Subnet Mask:** the default Subnet mask on the router.

**IGMP Snooping:** Enable or disable the IGMP Snooping function. Without IGMP snooping, multicast traffic is treated in the same manner as broadcast traffic - that is, it is forwarded to all ports. With IGMP snooping, multicast traffic of a group is only forwarded to ports that have members of that group.”

When enabled, you will see two modes:

- ① **Standard Mode:** In standard mode, multicast traffic will flood to all bridge ports when no client subscribes to a multicast group.
- ① **Blocking Mode:** In blocking mode, the multicast data will be blocked when there are no client subscribes to a multicast group, it won't flood to the bridge ports.

**LAN side firewall:** Enable to drop all traffic from the specified LAN group interface. After activating it,

all incoming packets by default will be dropped, and the user on the specified LAN group interface can't access CPE anymore. But, you can still access the internet service. If user wants to manage the CPE, please turn to [IP Filtering Incoming](#) to add the allowing rules. **Note** that all incoming packets by default will be dropped if the LAN side firewall is enabled and user cannot manage this CPE from the specified LAN group.

## DHCP Server

You can disable or enable the DHCP (Dynamic Host Configuration Protocol) server or enable the router's DHCP relay functions. The DHCP protocol allows your router to dynamically assign IP addresses to PCs on your network if they are configured to obtain IP addresses automatically.

### ① Disable

DHCP Server	
DHCP Server	Disable

Disable the DHCP Server function.

### ① Enable

Enable the DHCP function, enter the information wanted. Here as default.

DHCP Server	
DHCP Server	Enable
Start IP Address	192.168.1.100
End IP Address	192.168.1.199
Leased Time (hour)	24
Option 66	<input type="checkbox"/> Enable
Use Router's setting as DNS Server	<input checked="" type="checkbox"/>
Primary DNS server	
Secondary DNS server	

**Start IP Address:** The start IP address of the range the DHCP Server used to assign to the Clients.

**End IP Address:** The end IP address of the range the DHCP Server used to assign to the Clients.

**Leased Time (hour):** The leased time for each DHCP Client.

**Option 66:** Click Enable to activate DHCP option 66 for some special devices, like IPTV Set Box. The devices can get firmware or some special service from the TFTP server. User needs to set the IP or hostname of the TFTP server.

**User Router's setting as DNS server:** Select whether to enable use router's setting as DNS server to allow different LAN group with different DNS server settings.

If enabled, the PCs on the LAN side obtain the router's setting as DNS server. If disabled, please specify exactly the primary/secondary DNS server.

**Primary/Secondary DNS server:** Specify your primary/secondary DNS server for your LAN devices.

### ① DHCP Server Relay

DHCP Server	
DHCP Server	DHCP Server Relay
DHCP Server IP Address	

**DHCP Server IP Address:** Please enter the DHCP Server IP address.

## Static IP List

The specified IP will be assigned to the corresponding MAC Address listed in the following table when DHCP Server assigns IP Addresses to Clients.

Static IP Lease List				
Host Label	MAC Address	IP Address	Remove	Edit
<input type="button" value="Add"/>				

Press **Add** to the Static IP List.



The image shows a configuration window titled "Configuration" with a sub-section for "Static IP". Under "Parameters", there are three input fields: "Host Label", "MAC Address", and "IP Address". Below these fields are "Apply" and "Cancel" buttons.

Enter the MAC Address, IP Address, and then click Apply to confirm your settings. But the IP assigned should be outside the range of 192.168.1.100-192.168.1.199.

Static IP Lease List				
Host Label	MAC Address	IP Address	Remove	Edit
HP	18:a9:05:38:04:05	192.168.1.200	<input type="checkbox"/>	<input type="button" value="Edit"/>

## IP Alias

This function allows the creation of multiple virtual IP interfaces on this router. It helps to connect two or more local networks to the ISP or remote node.



The image shows an "IP Alias" configuration window. It has a section for "IP Alias" with a checkbox labeled "Enable". Below this are input fields for "IP Address" and "Subnet Mask". At the bottom are "Apply" and "Cancel" buttons.

**IP Alias:** Check whether to enable this function.

**IP Address:** Specify an IP address on this virtual interface.

**Subnet Mask:** Specify a subnet mask on this virtual interface.

Click **Apply** to apply your settings.

## IPv6 Autoconfig

The IPv6 address composes of two parts, the prefix and the interface ID.

There are two ways to dynamically configure IPv6 address on hosts. One is “stateful” configuration, for example using DHCPv6 (which resembles its counterpart DHCP in IPv4.) In the stateful auto-configuration model, hosts obtain interface addresses and/or configuration information and parameters from a DHCPv6 server. The Server maintains a database that keeps track of which addresses have been assigned to which hosts.

The second way is “stateless” configuration. Stateless auto-configuration requires no manual configuration of hosts, minimal (if any) configuration of routers, and no additional servers. The stateless mechanism allows a host to generate its own addresses using a combination of locally available information (MAC address) and information (prefix) advertised by routers. Routers advertise prefixes that identify the subnet(s) associated with a link, while hosts generate an “interface identifier” that uniquely identifies an interface on a subnet. An address is formed by combining the two. When using stateless configuration, you needn’t configure anything on the client.

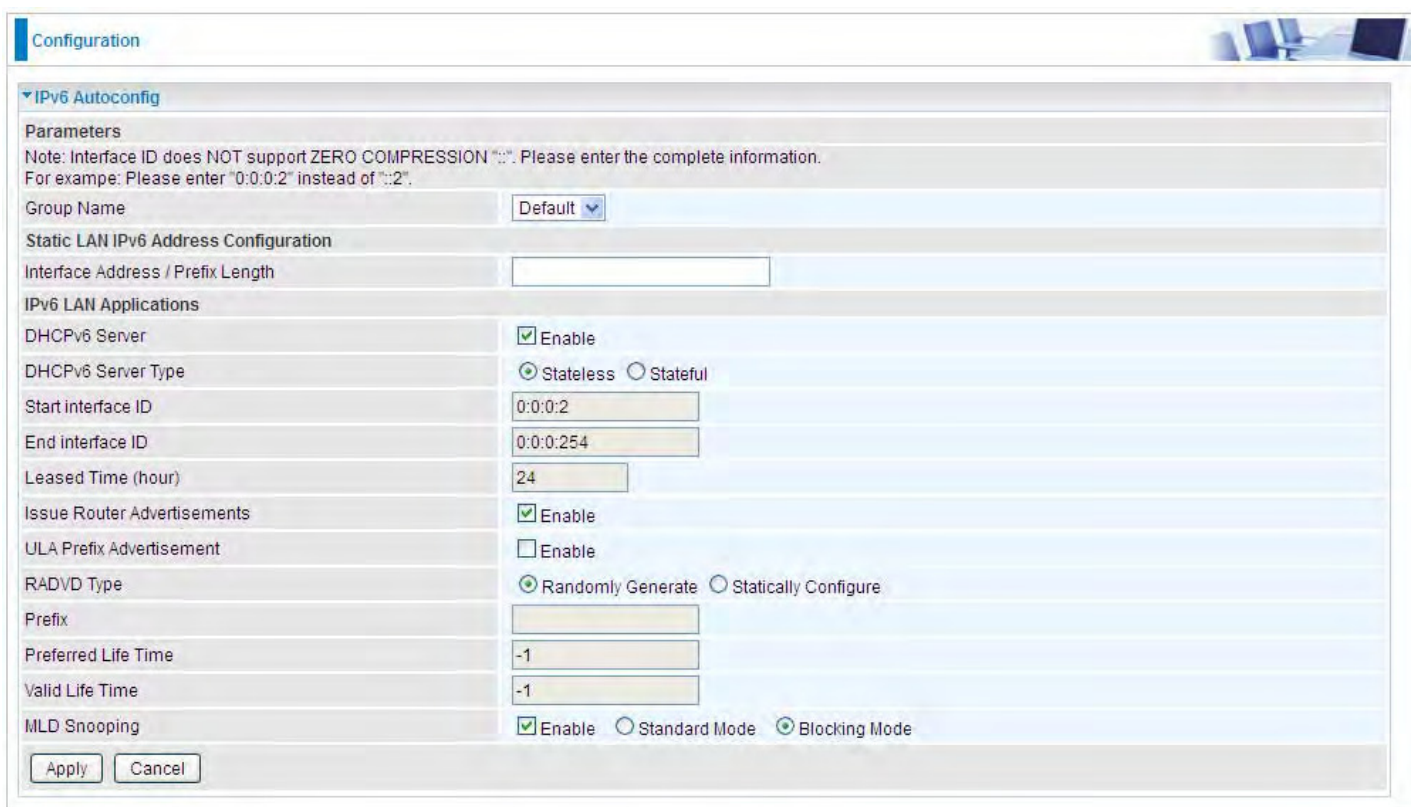

The screenshot shows the 'Configuration' page for IPv6 Autoconfig. It includes a 'Parameters' section with a note about interface ID formatting. Below that is a 'Group Name' dropdown set to 'Default'. The 'Static LAN IPv6 Address Configuration' section has an empty 'Interface Address / Prefix Length' field. The 'IPv6 LAN Applications' section contains several settings: 'DHCPv6 Server' is checked 'Enable'; 'DHCPv6 Server Type' is set to 'Stateless'; 'Start interface ID' is '0:0:0:2', 'End interface ID' is '0:0:0:254', and 'Leased Time (hour)' is '24'; 'Issue Router Advertisements' is checked 'Enable'; 'ULA Prefix Advertisement' is unchecked; 'RADVD Type' is set to 'Randomly Generate'; 'Prefix', 'Preferred Life Time', and 'Valid Life Time' are all set to '-1'; and 'MLD Snooping' is checked 'Enable' with 'Blocking Mode' selected. 'Apply' and 'Cancel' buttons are at the bottom.

**Group Name:** Here group refers to the group you set in **Interface Grouping** section, you can set the parameters for the specific group. Select the group by the drop-down box. For more information please refer to **Interface Grouping** of this manual.

### Static LAN IPv6 Address Configuration

**Interface Address / Prefix Length:** Enter the static LAN IPv6 address.

### IPv6 LAN application

**DHCPv6 Server:** Check whether to enable DHCPv6 server.

**DHCPv6 Server Type:** Select Stateless or Stateful. When DHCPv6 is enabled, this parameter is

available. **Stateless:** If selected, the PCs in LAN are configured through RA mode, thus, the PCs in LAN are configured through RA mode, to obtain the prefix message and generate an address using a combination of locally available information (MAC address) and information (prefix) advertised by routers, but they can obtain such information like DNS from DHCPv6 Server. **Stateful:** if selected, the PCs in LAN will be configured like in IPv4 mode, thus obtain addresses and DNS information from DHCPv6 server.

**Start interface ID:** Enter the start interface ID. The IPv6 address composed of two parts, thus, the prefix and the interface ID. Interface is like the Host ID compared to IPv4.

**End interface ID:** Enter the end interface ID.

**Note:** Interface ID does NOT support ZERO COMPRESSION ":::". Please enter the complete information.

For example: Please enter "0:0:0:2" instead of "::2".

**Leased Time (hour):** The leased time, similar to leased time in DHCPv4, is a time limit assigned to clients, when expires, the assigned ID will be recycled and reassigned.

**Issue Router Advertisement:** Check whether to enable issue Router Advertisement feature. It is to send Router Advertisement messages periodically.

**ULA Prefix Advertisement:** Enable this parameter to include the ipv6 ULA address in the RA messages. ULA, unique local address, is an IPv6 address in the block fc00::/7. It is approximately the IPv6 counterpart of the IPv4 private address. They are not routable in the global IPv6 Internet.

**RADVD Type:** The way that ULA prefix is generated.

- ① Randomly Generated
- ① Statically Configured: select to set manually in the following parameters.

**Prefix:** Set the prefix manually.

**Preferred Life Time:** The ULA prefix life time. When the time is over, the ULA prefix is invalid any more, -1 means no limit.

**Valid Life Time:** It is a time threshold, when the time is over, clients should obtain new IPv6 address from the router through RA; -1 means to be limitless.

**MLD snooping:** Similar to IGMP snooping, listens in on the MLD conversation between hosts and routers by processing MLD packets sent in a multicast network, and it analyzes all MLD packets between hosts and the connected multicast routers in the network. Without MLD snooping, multicast traffic is treated in the same manner as broadcast traffic - that is, it is forwarded to all ports. With MLD snooping, multicast traffic of a group is only forwarded to ports that have members of that group.

- ① **Standard Mode:** In standard mode, multicast traffic will flood to all bridge ports when no client subscribes to a multicast group.
- ① **Blocking Mode:** In blocking mode, the multicast data will be blocked when there is no client subscribes to a multicast group, it won't flood to the bridge ports.

## Stateless and Stateful IPv6 address Configuration

**Stateless:** Two methods can be carried.

- ① With DHCPv6 disabled, but Issue Router Advertisement Enabled

DHCPv6 Server	<input type="checkbox"/> Enable
Issue Router Advertisements	<input checked="" type="checkbox"/> Enable

With this method, the PCs in LAN are configured through RA mode, thus, the PCs in LAN are configured through RA mode, to obtain the prefix message and generate an address using a combination of locally available information (MAC address) and information (prefix) advertised by routers.

- ① With both DHCPv6 and Issue Router Advertisement Enabled

DHCPv6 Server	<input checked="" type="checkbox"/> Enable
DHCPv6 Server Type	<input checked="" type="radio"/> Stateless <input type="radio"/> Stateful
Start interface ID	<input type="text" value="0:0:0:2"/>
End interface ID	<input type="text" value="0:0:0:254"/>
Leased Time (hour)	<input type="text" value="24"/>
Issue Router Advertisements	<input checked="" type="checkbox"/> Enable

With this method, the PCs' addresses in LAN are configured like above method, but they can obtain such information like DNS from DHCPv6 Server.

**Stateful:** two methods can be adopted.

① With only DHCPv6 enabled

DHCPv6 Server	<input checked="" type="checkbox"/> Enable
DHCPv6 Server Type	<input type="radio"/> Stateless <input checked="" type="radio"/> Stateful
Start interface ID	<input type="text" value="0:0:0:2"/>
End interface ID	<input type="text" value="0:0:0:254"/>
Leased Time (hour)	<input type="text" value="24"/>
Issue Router Advertisements	<input type="checkbox"/> Enable

With this method, the PCs' addresses are configured the same as in IPv4, that is addresses are assigned by DHCPv6 server.

① With both DHCPv6 and Issue Router Advertisement Enabled

DHCPv6 Server	<input checked="" type="checkbox"/> Enable
DHCPv6 Server Type	<input type="radio"/> Stateless <input checked="" type="radio"/> Stateful
Start interface ID	<input type="text" value="0:0:0:2"/>
End interface ID	<input type="text" value="0:0:0:254"/>
Leased Time (hour)	<input type="text" value="24"/>
Issue Router Advertisements	<input checked="" type="checkbox"/> Enable

With this method, the PCs' addresses are configured the same like above, and the address information in RA packets will be neglected.

## Interface Grouping

Interface grouping is a function to group interfaces, known as VLAN. A Virtual LAN, commonly known as a VLAN, is a group of hosts with the common set of requirements that communicate as if they were attached to the same broadcast domain, regardless of the physical location. A VLAN has the same attributes as a physical LAN, but it allows for end stations to be grouped together even if they are not located on the same network switch.

Each group will perform as an independent network. To support this feature, you must create mapping groups with appropriate LAN and WAN interfaces using the Add button.

(Please **Note**: P4 can be configured as EWAN, and when the device is in EWAN profile, there is no P4/EWAN interface as P4 is working as a WAN port.)

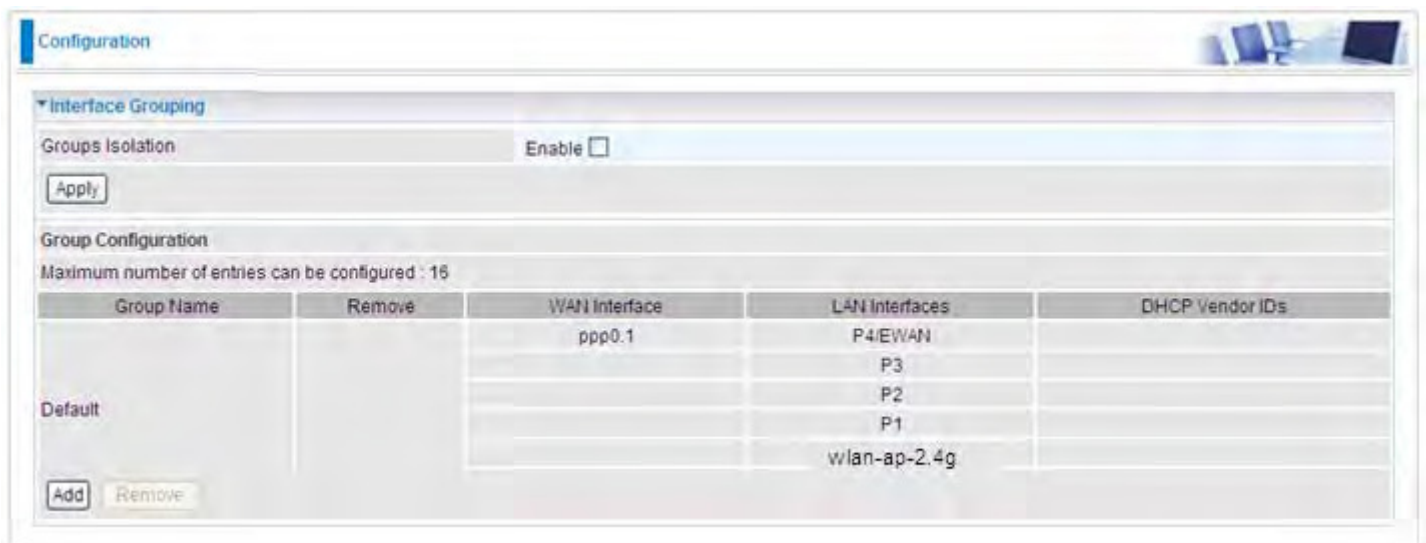

Configuration

Interface Grouping

Groups Isolation  Enable

Apply

Group Configuration

Maximum number of entries can be configured : 16

Group Name	Remove	WAN Interface	LAN Interfaces	DHCP Vendor IDs
Default		ppp0.1	P4/EWAN	
			P3	
			P2	
			P1	
			wlan-ap-2.4g	

Add Remove

**Group Isolation:** If enabled, devices in one group are not able to access those in the other group.



Click **Add** to add groups.

Configuration

**Interface grouping Configuration**

**Parameters**  
If you like to automatically add LAN clients to a WAN interface in the new group add the DHCP vendor ID string.  
By configuring a DHCP vendor ID string any DHCP client request with the specified vendor ID (DHCP option 60) will be denied an IP address from the local DHCP server.  
**IMPORTANT** If a vendor ID is configured for a specific client device, please REBOOT the client device attached to the modem to allow it to obtain an appropriate IP address.

Group Name

Grouped WAN Interfaces

Available WAN Interfaces  
pppoe\_0\_8\_35/ppp0.1

Grouped LAN Interfaces

Available LAN Interfaces  
P4/EWAN  
P3  
P2  
P1  
wlan-ap-2.4g

Automatically Add Clients With the following DHCP Vendor IDs

Apply Cancel

**Group Name:** Type a group name.

**Grouped WAN Interfaces:** Select from the box the WAN interface you want applied in the group.

**Grouped LAN Interfaces:** Select the LAN interfaces you want to group as a single group from **Available LAN Interfaces**.

**Automatically Add Clients with following DHCP Vendor IDs:** Enter the DHCP Vendor IDs for which you want the Clients automatically added into the group. DHCP vendor ID (DHCP 60) is an Authentication for DHCP Messages.

Click **Apply** to confirm your settings and your added group will be listed in the Interface Grouping table below.

In group "test", P2 and PPP0.1 are grouped in one group, they have their only network , see [LAN](#).

Configuration

Interface Grouping

Groups Isolation Enable

Apply

Group Configuration

Maximum number of entries can be configured : 15

Group Name	Remove	WAN Interface	LAN Interfaces	DHCP Vendor IDs
Default	<input type="checkbox"/>		P4/EWAN	
			P3	
			P1	
			wlan-ap-2.4g	
test	<input type="checkbox"/>	ppp0.1	P2	

Add Remove

If you want to remove the group, check the box as the following and press **Remove**.

Configuration

Interface Grouping

Groups Isolation Enable

Apply

Group Configuration

Maximum number of entries can be configured : 15

Group Name	Remove	WAN Interface	LAN Interfaces	DHCP Vendor IDs
Default	<input type="checkbox"/>		P4/EWAN	
			P3	
			P1	
			wlan-ap-2.4g	
test	<input checked="" type="checkbox"/>	ppp0.1	P2	

Add Remove

**Note:** If you like to automatically add LAN clients to a WAN Interface in the new group add the DHCP vendor ID string.

By configuring a DHCP vendor ID string any DHCP client request with the specified vendor ID (DHCP option 60) will be denied an IP address from the local DHCP server.

If a vendor ID is configured for a specific client device, please REBOOT the client device attached to the modem to allow it to obtain an appropriate IP address.

Each LAN interface can only be added into one group and one WAN interface can only be used in one group.

## LAN VLAN Setting

When LAN VLAN is opened on a LAN port, outgoing packets from the port will be tagged with the specific VLAN ID user set.



The screenshot shows the 'LAN VLAN Setting' configuration page. Under 'Parameters', there is a note: 'Note: Change VLAN parameter may affect interface grouping which grouped with this vlan interface. Therefore, please check your settings on interface grouping after modification done here.' The 'LAN Port' is set to 'P1'. The 'VLAN Mode' checkbox is unchecked. Below this is a table with columns for 'VLAN ID [1-4094]', 'Pbits [0-7]', and 'Remove'. The table is currently empty. At the bottom are 'Add' and 'Apply' buttons.

VLAN ID [1-4094]	Pbits [0-7]	Remove
------------------	-------------	--------

**LAN Port:** Select the LAN port users want to set LAN VLAN.

**VLAN Mode:** Check if to enable LAN VLAN for the select port.

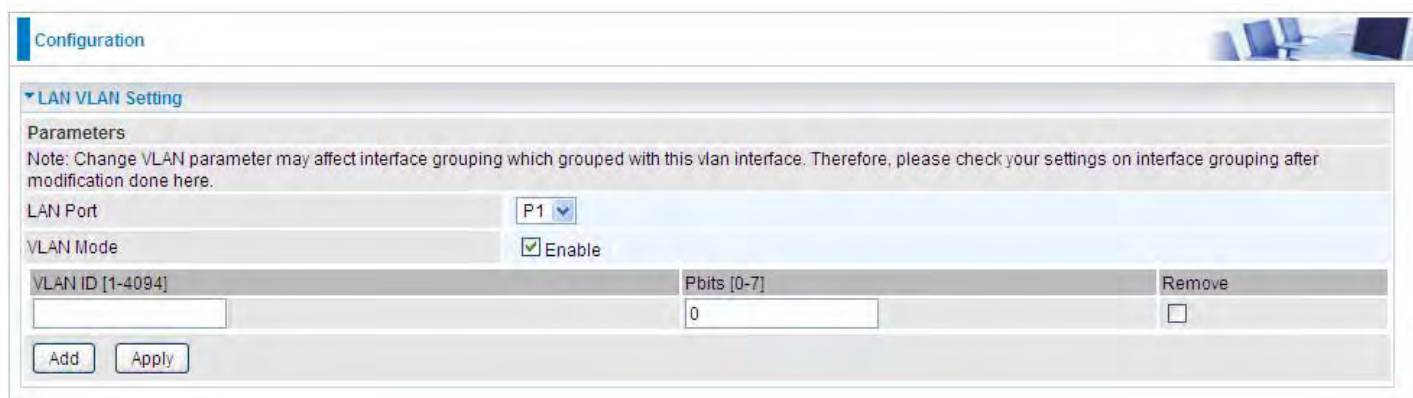

The screenshot shows the 'LAN VLAN Setting' configuration page. Under 'Parameters', there is a note: 'Note: Change VLAN parameter may affect interface grouping which grouped with this vlan interface. Therefore, please check your settings on interface grouping after modification done here.' The 'LAN Port' is set to 'P1'. The 'VLAN Mode' checkbox is checked. Below this is a table with columns for 'VLAN ID [1-4094]', 'Pbits [0-7]', and 'Remove'. The 'VLAN ID' field is empty, 'Pbits' is set to '0', and the 'Remove' checkbox is unchecked. At the bottom are 'Add' and 'Apply' buttons.

VLAN ID [1-4094]	Pbits [0-7]	Remove
	0	<input type="checkbox"/>

Click Add to set the VLAN ID, Pbits for the port.

**VLAN ID:** a parameter to specify the VLAN which the frame belongs. Enter the VLAN ID identification, tagged: 1-4094

**Pbits:** The parameter indicates the frame priority level from 0 (lowest) to 7 (highest), which can be used to prioritize different classes of traffic (voice, video, data, etc).

## Eth Port Control

Eth port control features the control of Ethernet port working patterns like Max Bit Rate and Duplex Mode.

Edit	Eth Port	Status	Max Bit Rate	Duplex Mode
<input type="radio"/>	P1	Down	Auto	Auto
<input type="radio"/>	P2	Up ( 100 mbps full duplex)	Auto	Auto
<input type="radio"/>	P3	Down	Auto	Auto
<input type="radio"/>	P4/EWAN	Down	Auto	Auto

Select to change the port working patterns in the Edit vertical column.

**Eth Port:** Select the port, P1-P4/EWAN.

**Max Bit Rate:** Manually specify the max bit rate for the Ethernet port, 10 or 100Mbps.

**Duplex Mode:** Manually specify the duplex mode for the Ethernet port, half or full duplex.

## VRRP

VRRP is designed to eliminate the single point of failure inherent in the static default routed environment. VRRP specifies an election protocol that dynamically assigns responsibility for a virtual router to one of the VRRP routers in a LAN. The VRRP router controlling the IP address associated with a virtual router is called the Master, and forwards packets sent to these IP addresses. The election process provides dynamic fail-over in the forwarding responsibility should the Master become unavailable. Any of the virtual router's IP addresses in a LAN can then be used as the default first hop router by end-hosts. The advantage gained from using VRRP is a higher availability default path without requiring configuration of dynamic routing or router discovery protocols on every end-host.



Configuration

▼ VRRP

Parameters

VRRP	<input type="radio"/> Enable <input checked="" type="radio"/> Disable
VRID	<input type="text" value="0"/>
Priority	<input type="text" value="0"/>
Preempt Mode	<input checked="" type="radio"/> True <input type="radio"/> False
VRIP	<input type="text"/>
Advertisement Period	<input type="text" value="1"/>

**VRRP:** Check Enable radio button to activate this function. The default setting is “Disable”.

**VRID:** A master or backup router running the VRRP protocol may participate in one VRID instance.

**Priority:** Specifies the sending VRRP router's priority for the virtual router. Higher values equal higher priority. The priority value for the VRRP router that owns the IP address associated with the virtual router **MUST** be 255. VRRP routers backing up a virtual router **MUST** use priority values between 1 and 254. The default priority value for VRRP routers backing up a virtual router is 100. The priority value zero (0) has special meaning indicating that the current Master has stopped participating in VRRP. This is used to trigger Backup routers to quickly transition to Master without having to wait for the current Master to timeout.

**Preempt Mode:** When preempt mode is enabled, a backup router always takes over the responsibility of the master router. When disabled, the lower priority backup is left in the master state.

**VRIP:** One IP address that is associated with the virtual router.

**Advertisement period:** Indicates the time interval in seconds between advertisements. The default value is 1 second.

# Wireless

This section provides you ways to configure wireless access. The BiPAC 7820NZ supports wireless on the 2.4GHz for users. This part has sub-items as [Basic](#), [Security](#), [MAC Filter](#), [Wireless Bridge](#), [Advanced](#) and [Station Info](#) here.

▶ Status
• Quick Start
▼ Configuration
▶ LAN
▼ Wireless
▪ Basic
▪ Security
▪ MAC Filter
▪ Wireless Bridge
▪ Advanced
▪ Station Info
▪ Schedule Control
▶ WAN
▶ System
▶ USB
▶ IP Tunnel
▶ Security
▶ Quality of Service
▶ NAT
▪ Wake On LAN
▶ VPN
▶ Advanced Setup

## Basic

It let you determine whether to enable Wireless function and set the basic parameters of an AP and the Virtual APs.

Wireless - Guest/Virtual Access Points							
SSID	Hidden	Clients Isolation	Disable WMM Advertise	WMF	Max Clients	BSSID	Enable
w10_Guest1	<input type="checkbox"/>	<input type="checkbox"/>	<input type="checkbox"/>	<input type="checkbox"/>	16	N/A	<input type="checkbox"/>
w10_Guest2	<input type="checkbox"/>	<input type="checkbox"/>	<input type="checkbox"/>	<input type="checkbox"/>	16	N/A	<input type="checkbox"/>
w10_Guest3	<input type="checkbox"/>	<input type="checkbox"/>	<input type="checkbox"/>	<input type="checkbox"/>	16	N/A	<input type="checkbox"/>

**Wireless:** Default setting is set to Enable. If you do not have any wireless devices, check the checkbox again to unselect.

**Hide SSID:** It is function in which transmits its SSID to the air so that when wireless client searches for a network, router can then be discovered and recognized. Check the checkbox to determine whether you want to hide SSID.

**Clients Isolation:** if you enabled this function, then each of your wireless clients will not be able to communicate with each other.

**Disable WMM Advertise:** Stop the router from 'advertising' its Wireless Multimedia (WMM) functionality, which provides basic quality of service for time-sensitive applications (e.g. VoIP, Video).

Check to disable or enable this function.

**Wireless multicast Forwarding (WMF):** check to enable or disable wireless multicast forwarding.

**SSID:** The SSID is the unique name of a wireless access point (AP) to be distinguished from another. For security purpose, change the default wlan-ap-2.4g to a unique ID name to the AP already built-in to the router's wireless interface. It is case sensitive and must not exceed 32 characters. Make sure your wireless clients have exactly the SSID as the device, in order to get connected to your network.

**Note:** SSID is case sensitive and must not exceed 32 characters.

**BSSID:** Basic Set Service Identifier, it is a local managed IEEE MAC address, and is 48 bits value.

**Country:** Different countries have different wireless band resources, so you can select the appropriate Country according to your location.

**Max Clients:** enter the number of max clients the wireless network can supports,1-16.

**Guest/virtual Access Points:** A "Virtual Access Point" is a logical entity that exists within a physical Access Point (AP). When a single physical AP supports multiple "Virtual APs", each Virtual AP appears to stations (STAs) to be an independent physical AP, even though only a single physical AP is present. For example, multiple Virtual APs might exist within a single physical AP, each advertising a distinct SSID and capability set. Alternatively, multiple Virtual APs might advertise the same SSID but a different capability set – allowing access to be provided via Web Portal, WEP, and WPA

simultaneously. Where APs are shared by multiple providers, Virtual APs provide each provider with separate authentication and accounting data for their users, as well as diagnostic information, without sharing sensitive management traffic or data between providers. You can enable the virtual AP.

Here you can enable some Virtual APs according to the request. And the other parameters of virtual APs are the same to the above.

Click **Apply** to apply your settings.



## Security

Wireless security prevents unauthorized access or damage to computers using wireless network.

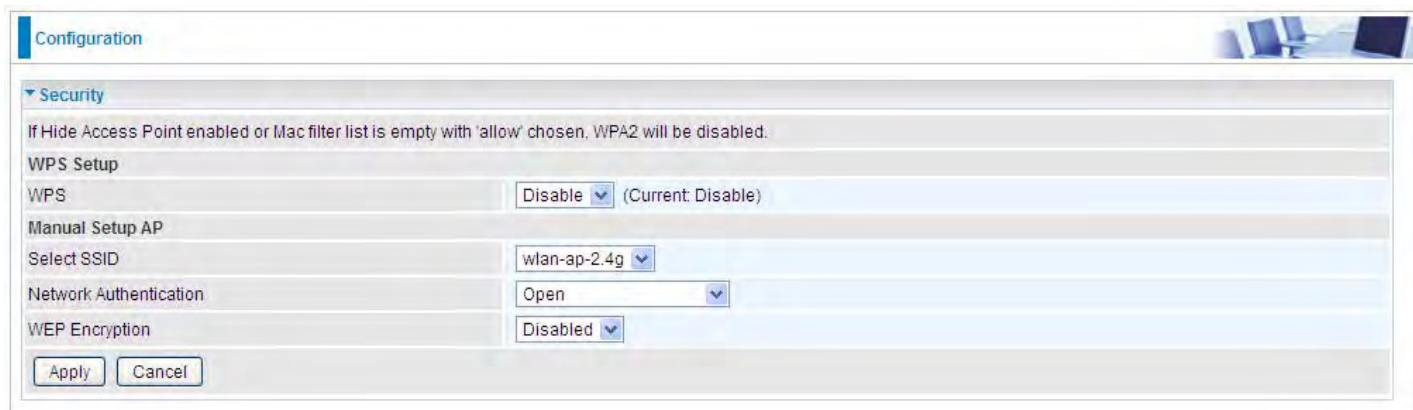

The screenshot shows a 'Configuration' window with a 'Security' section. A note at the top states: 'If Hide Access Point enabled or Mac filter list is empty with 'allow' chosen, WPA2 will be disabled.' Below this, the 'WPS Setup' section has a 'WPS' dropdown set to 'Disable' (Current: Disable). The 'Manual Setup AP' section has a 'Select SSID' dropdown set to 'wlan-ap-2.4g', a 'Network Authentication' dropdown set to 'Open', and a 'WEP Encryption' dropdown set to 'Disabled'. 'Apply' and 'Cancel' buttons are at the bottom.

### Note:

The WPS feature will also be unavailable when the security setting is not WPA2 or OPEN. So, if you manually set the wireless security setting, you should give notice to it, but you can find prompt indicating configuration.

## Manual Setup AP

**Select SSID:** select the SSID you want these settings apply to.

### Network Authentication

#### ① Open

Network Authentication	Open
WEP Encryption	Enable
Encryption Strength	128-bit
Current Network Key	1
Network Key 1	1234567890123
Network Key 2	1234567890123
Network Key 3	1234567890123
Network Key 4	1234567890123

Enter 13 ASCII characters or 26 hexadecimal digits for 128-bit encryption keys.  
Enter 5 ASCII characters or 10 hexadecimal digits for 64-bit encryption keys.

**WEP Encryption:** Select to enable or disable WEP Encryption. Here select Enable.

**Encryption Strength:** Select the strength, 128-bit or 64-bit.

**Current Network Key:** Select the one to be the current network key. Please refer to key 1- 4 below.

**Network Key (1- 4):** Enter 13 ASCII characters or 26 hexadecimal digits for 128-bit encryption keys.  
Enter 5 ASCII characters or 10 hexadecimal digits for 64-bit encryption keys.

## ① Shared

This is similar to network authentication 'Open'. But here the WEP Encryption must be enabled.

Network Authentication	Shared
WEP Encryption	Enable
Encryption Strength	128-bit
Current Network Key	2
Network Key 1	1234567890123
Network Key 2	1234567890123
Network Key 3	1234567890123
Network Key 4	1234567890123

Enter 13 ASCII characters or 26 hexadecimal digits for 128-bit encryption keys.  
Enter 5 ASCII characters or 10 hexadecimal digits for 64-bit encryption keys.

## ① 802.1x

Network Authentication	802.1X
RADIUS Server IP Address	0.0.0.0
RADIUS Port	1812
RADIUS Key	
WEP Encryption	Enable
Encryption Strength	128-bit
Current Network Key	2
Network Key 1	1234567890123
Network Key 2	1234567890123
Network Key 3	1234567890123
Network Key 4	1234567890123

Enter 13 ASCII characters or 26 hexadecimal digits for 128-bit encryption keys.  
Enter 5 ASCII characters or 10 hexadecimal digits for 64-bit encryption keys.

**RADIUS Server IP Address:** RADIUS( Remote Authentication Dial In User Service), Enter the IP address of RADIUS authentication server.

**RADIUS Server Port:** Enter the port number of RADIUS authentication server here.

**RADIUS Key:** Enter the password of RADIUS authentication server.

**WEP Encryption:** Select to enable or disable WEP Encryption. Here select Enable.

**Current Network Key:** Select the one to be the current network key. Please refer to key 2- 3 below.

**Network Key (1- 4):** Enter 13 ASCII characters or 26 hexadecimal digits for 128-bit encryption keys.  
Enter 5 ASCII characters or 10 hexadecimal digits for 64-bit encryption keys.

## ① WPA

Network Authentication	<input type="text" value="WPA"/>
WPA Group Rekey Interval	<input type="text" value="3600"/> [0-2147483647]
RADIUS Server IP Address	<input type="text" value="0.0.0.0"/>
RADIUS Port	<input type="text" value="1812"/>
RADIUS Key	<input type="text"/>
WPA/WAPI Encryption	<input type="text" value="TKIP+AES"/>
WEP Encryption	<input type="text" value="Disabled"/>

**WPA Group ReKey Internal:** The period of renewal time for changing the security key automatically between wireless client and Access Point (AP). This is in seconds.

**RADIUS Server IP Address:** RADIUS( Remote Authentication Dial In User Service), Enter the IP address of RADIUS authentication server.

**RADIUS Server Port:** Enter the port number of RADIUS authentication server here.

**RADIUS Key:** Enter the password of RADIUS authentication server.

**WPA/WAPI Encryption:** There are two Algorithms, AES (Advanced Encryption Standard) and TKIP(Temporal Key Integrity Protocol) which help to protect the wireless communication.

## ① WPA-PSK / WPA2-PSK

Network Authentication	<input type="text" value="WPA-PSK"/>
WPA/WAPI passphrase	<input type="text" value="••••••••"/> <a href="#">Click here to display</a>
WPA Group Rekey Interval	<input type="text" value="3600"/> [0-2147483647]
WPA/WAPI Encryption	<input type="text" value="TKIP+AES"/>
WEP Encryption	<input type="text" value="Disabled"/>

**WPA/WAPI passphrase:** Enter the WPA.WAPI passphrase; you can **click here to display** to view it.

**WPA Group ReKey Internal:** The period of renewal time for changing the security key automatically between wireless client and Access Point (AP). This is in seconds.

**WPA/WAPI Encryption:** There are two Algorithms, AES (Advanced Encryption Standard) and TKIP(Temporal Key Integrity Protocol) which help to protect the wireless communication.

## ① WPA2

Network Authentication	WPA2
WPA2 Preauthentication	Disable
Network Re-auth Interval	36000 [0-2147483647]
WPA Group Rekey Interval	3600 [0-2147483647]
RADIUS Server IP Address	0.0.0.0
RADIUS Port	1812
RADIUS Key	
WPA/WAPI Encryption	AES
WEP Encryption	Disabled

**WPA2 Preauthentication:** When a wireless client wants to handoff to another AP, with preauthentication, it can perform 802.1X authentication to the new AP, and when handoff happens, this mode will help reduce the association time.

**Network Re-auth Interval:** the interval for network Re-authentication. This is in seconds.

**WPA Group ReKey Internal:** The period of renewal time for changing the security key automatically between wireless client and Access Point (AP). This is in seconds.

**RADIUS Server IP Address:** RADIUS( Remote Authentication Dial In User Service), Enter the IP address of RADIUS authentication server. This is in seconds.

**RADIUS Server Port:** Enter the port number of RADIUS authentication server here.

**RADIUS Key:** Enter the password of RADIUS authentication server.

**WPA/WAPI Encryption:** There are two Algorithms, AES (Advanced Encryption Standard) and TKIP(Temporal Key Integrity Protocol) which help to protect the wireless communication.

## ① Mixed WPA2/WPA

Network Authentication	Mixed WPA2/WPA
WPA2 Preauthentication	Disable
Network Re-auth Interval	36000 [0-2147483647]
WPA Group Rekey Interval	3600 [0-2147483647]
RADIUS Server IP Address	0.0.0.0
RADIUS Port	1812
RADIUS Key	
WPA/WAPI Encryption	AES
WEP Encryption	Disabled

**WPA2 Preauthentication:** When a wireless client wants to handoff to another AP, with preauthentication, it can perform 802.1X authentications to the new AP, and when handoff happens, this mode will help reduce the association time used.

**Network Re-auth Interval:** the interval for network Re-authentication. The unit is second.

**WPA Group ReKey Internal:** The period of renewal time for changing the security key automatically between wireless client and Access Point (AP). This is in seconds.

**RADIUS Server IP Address:** RADIUS( Remote Authentication Dial In User Service), Enter the IP address of RADIUS authentication server.

**RADIUS Server Port:** Enter the port number of RADIUS authentication server here.

**RADIUS Key:** Enter the password of RADIUS authentication server.

**WPA/WAPI Encryption:** There are two Algorithms, AES (Advanced Encryption Standard) and

TKIP(Temporal Key Integrity Protocol) which help to protect the wireless communication.

### ① Mixed WPA2/WPA-PSk

Network Authentication	Mixed WPA2/WPA -PSK
WPA/WAPI passphrase	●●●●●●●● <a href="#">Click here to display</a>
WPA Group Rekey Interval	3600 [0-2147483647]
WPA/WAPI Encryption	AES
WEP Encryption	Disabled

**WPA/WAPI passphrase:** enter the WPA.WAPI passphrase, you can **click here to display** to view it.

**WPA Group ReKey Internal:** The period of renewal time for changing the security key automatically between wireless client and Access Point (AP). The unit is second.

**WPA/WAPI Encryption:** There are two Algorithms, AES (Advanced Encryption Standard) and TKIP(Temporal Key Integrity Protocol) which help to protect the wireless communication.

## WPS Setup

WPS (Wi-Fi Protected Setup) feature is a standard protocol created by Wi-Fi Alliance. WPS is used to exchange the AP setting with Station and configure Ap settings. This feature greatly simplifies the steps needed to create a Wi-Fi network for a residential or an office setting. The commonly known **PIN method** is supported to configure WPS.

**WPS:** Select enable to enable WPS function. Please note that WPS can only be available when WPA2-PSK or OPEN mode is configured.

### Note:

- 1) WPS feature is only available when in WPA2 or OPEN mode in security settings.
- 2) Here wireless can be configured as **Registrar** and **Enrollee** mode respectively. When AP is configured as Registrar, you should select “Configured” in the WPS AP Mode below, and default WPS AP Mode is “Configured”. When AP is configured as Enrollee, the WPS AP Mode below should be changed to “Unconfigured”. Follow the following steps.



The screenshot shows a web-based configuration page for WPS Setup. The page is titled "Configuration" and has a "Security" tab selected. A warning message states: "If Hide Access Point enabled or Mac filter list is empty with 'allow' chosen, WPA2 will be disabled." The WPS Setup section includes the following fields and options:

- WPS:** A dropdown menu set to "Enable" (Current: Disable).
- Add Client:** Radio buttons for "Enter STA PIN" (selected) and "Use AP PIN", followed by an "Add Enrollee" button. A note states: "(This feature is available only when WPA2 PSK or OPEN mode is configured)".
- PIN:** A text input field with a "Help" link.
- Authorized Station MAC:** A text input field with a "Help" link.
- WPS AP Mode:** A dropdown menu set to "Configured".
- Setup AP:** A text input field containing "10864111" with a "Help" link.
- Manual Setup AP:** A section header for manual configuration.
- Select SSID:** A dropdown menu set to "wlan-ap-2.4g".
- Network Authentication:** A dropdown menu set to "Open".
- WEP Encryption:** A dropdown menu set to "Disabled".

At the bottom of the form are "Apply" and "Cancel" buttons.

## Configure AP as Registrar

### ● Add Enrollee with PIN method

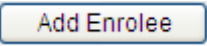
1. Select radio button “**Enter STA PIN**”.
2. Input PIN from Enrollee Station (16837546 in this example), Or else users can **alternatively** enter the authorized station MAC **Help:** it is to help users to understand the concept and correct operation.
3. Click .



The screenshot shows the 'Configuration' page for WPS Setup. The 'WPS' dropdown is set to 'Enable'. Under 'Add Client', the 'Enter STA PIN' radio button is selected. The 'PIN' field contains '16837546'. The 'Authorized Station MAC' field is empty. The 'WPS AP Mode' is 'Configured' and the 'Setup AP' is '10864111'. The 'Manual Setup AP' section shows 'wlan-ap-2.4g' for SSID, 'Open' for Network Authentication, and 'Disabled' for WEP Encryption. 'Apply' and 'Cancel' buttons are at the bottom.

(Station PIN)



The screenshot shows the 'Configuration' page for WPS Setup. The 'WPS' dropdown is set to 'Enable'. Under 'Add Client', the 'Use AP PIN' radio button is selected. The 'PIN' field is empty. The 'Authorized Station MAC' field contains '18:A9:05:38:04:08'. The 'WPS AP Mode' is 'Configured' and the 'Setup AP' is '10864111'. The 'Manual Setup AP' section shows 'wlan-ap-2.4g' for SSID, 'Open' for Network Authentication, and 'Disabled' for WEP Encryption. 'Apply' and 'Cancel' buttons are at the bottom.

(Station MAC)

**Note:** Users can **alternatively** input PIN from Enrollee Station or enter the authorized station MAC.

- Operate Station to start WPS Adding Enrollee. Launch the wireless client's WPS utility (eg. Ralink Utility). Set the Config Mode as Enrollee, press the WPS button on the top bar, select the AP (eg. Wlan-ap-2.4g) from the WPS AP List column. Then press the PIN button located on the middle left of the page to run the scan.

The screenshot displays the WPS utility interface with the following components:

- Navigation Bar:** Profile, Network, Advanced, Statistics, WMM, WPS, Radio On/Off, About.
- WPS AP List:**

ID	AP Name	MAC Address	Priority
0x0000	wlan-ap	00-04-ED-01-00-02	1
	wlan-ap-2.4g	00-04-ED-00-00-01	1
- WPS Profile List:** (Empty list)
- WPS Configuration:**
  - PIN
  - WPS Associate IE
  - PBC
  - WPS Probe IE
  - Progress >> 0%
  - WPS status is disconnected
- Right Panel:** Rescan, Information, Pin Code (16837546), Renew, Config Mode (Enrollee), Detail, Connect, Rotate, Disconnect, Export Profile, Delete.
- Status & Performance Section:**
  - Status >> Disconnected
  - Link Quality >> 0%
  - Signal Strength 1 >> 0%
  - Signal Strength 2 >> 0%
  - Noise Strength >> 0%
  - Transmit: Link Speed >> Max, Throughput >> 0.000 Kbps
  - Receive: Link Speed >> Max, Throughput >> 0.000 Kbps
  - HT: BW >> n/a, SNR0 >> n/a, GI >> n/a, MCS >> n/a, SNR1 >> n/a



4. The client's SSID and security settings will now be configured to match the SSID and security settings of the registrar.

The screenshot displays a network configuration interface with several sections:

- WPS AP List:** A table listing available WPS APs. The first entry is 'wlan-ap-2.4g' with ID '00-04-ED-01-00-01' and priority '1'. The second entry is 'wlan-ap' with ID '00-04-ED-38-F7-2E' and priority '1'.
- WPS Profile List:** A list containing the profile 'wlan-ap'. Below it, there are checkboxes for 'WPS Associate IE' and 'WPS Probe IE', both of which are checked. A progress bar indicates 'Progress >> 100%' and a message states 'PIN - Get WPS profile successfully.'
- Right Panel:** A vertical stack of buttons including 'Rescan', 'Information', 'Pin Code' (with input '16837546' and 'Renew' button), 'Config Mode' (with a dropdown menu set to 'Enrollee'), 'Detail', 'Connect', 'Rotate', 'Disconnect', 'Export Profile', and 'Delete'.
- Connection Status:** A detailed view of the 'wlan-ap-2.4g' connection. It shows 'Status >> wlan-ap-2.4g <--> 00-04-ED-01-00-01', 'Extra Info >> Link is Up [TxPower:100%]', 'Channel >> 1 <--> 2412 MHz; central channel 3', 'Authentication >> Open', 'Encryption >> NONE', 'Network Type >> Infrastructure', 'IP Address >> 192.168.1.100', 'Sub Mask >> 255.255.255.0', and 'Default Gateway >> 192.168.1.254'. A red ellipse highlights the 'Authentication >> Open' and 'Encryption >> NONE' lines. Below this, it shows 'HT' settings: 'BW >> 40', 'SNR0 >> 19', 'GI >> long', 'MCS >> 15', and 'SNR1 >> n/a'.
- Performance Metrics:** On the right, there are color-coded bars for 'Link Quality >> 100%' (green), 'Signal Strength 1 >> 64%' (yellow), 'Signal Strength 2 >> 34%' (red), and 'Noise Strength >> 26%' (green). Below these are 'Transmit' and 'Receive' sections, each showing 'Link Speed' and 'Throughput' with corresponding signal strength graphs. Transmit: Link Speed >> 270.0 Mbps, Throughput >> 5.600 Kbps. Receive: Link Speed >> 54.0 Mbps, Throughput >> 81.608 Kbps.

You can check the message in the red ellipse with the security parameters you set, here we all use the default.

## Configure AP as Enrollee

### ● Add Registrar with PIN Method

1. Set AP to “*Unconfigured Mode*”.

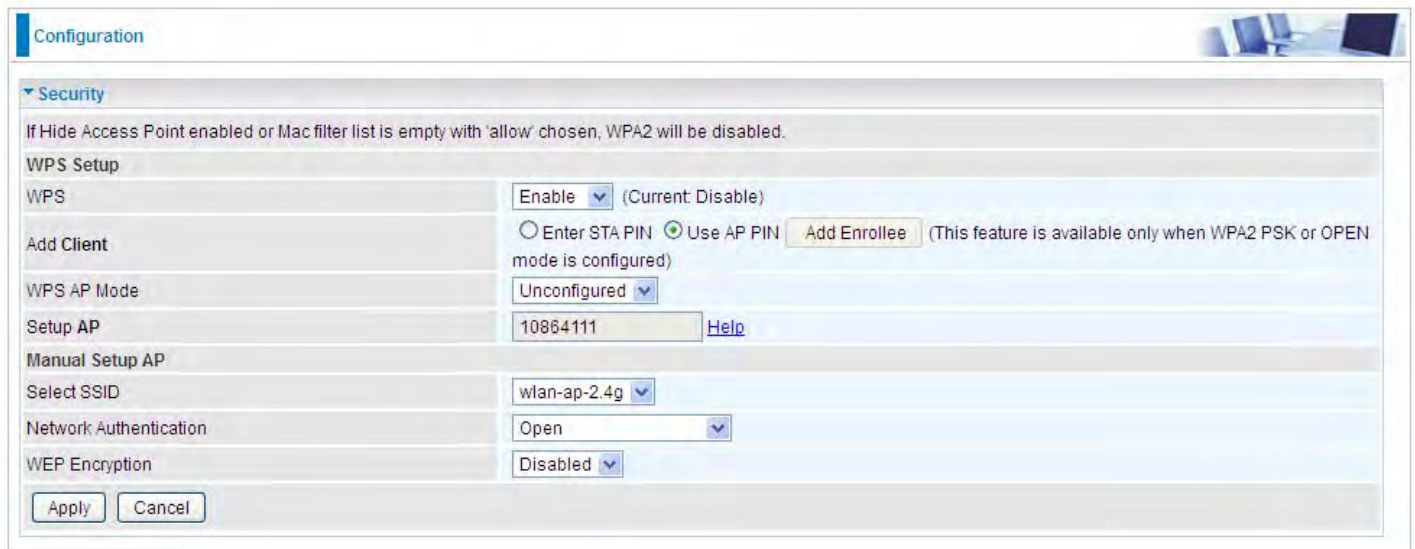

The screenshot shows the 'Configuration' page with the 'Security' section expanded. The 'WPS Setup' section is visible, containing the following fields and options:

- WPS:** A dropdown menu set to 'Enable' (Current: Disable).
- Add Client:** Two radio buttons: 'Enter STA PIN' (unselected) and 'Use AP PIN' (selected). An 'Add Enrollee' button is present next to the 'Use AP PIN' option. A note states: '(This feature is available only when WPA2 PSK or OPEN mode is configured)'. Below this are the 'WPS AP Mode' and 'Setup AP' fields.
- WPS AP Mode:** A dropdown menu set to 'Unconfigured'.
- Setup AP:** A text input field containing '10864111' and a 'Help' link.
- Manual Setup AP:** A section header.
- Select SSID:** A dropdown menu set to 'wlan-ap-2.4g'.
- Network Authentication:** A dropdown menu set to 'Open'.
- WEP Encryption:** A dropdown menu set to 'Disabled'.

At the bottom of the configuration area, there are 'Apply' and 'Cancel' buttons.

2. Launch the wireless client's WPS utility (eg. Ralink Utility). Set the Config Mode as **Registrar**. Enter the **PIN** number (10864111 (device) for example) in the PIN Code column then choose the correct AP (eg. wlan-ap-2.4g) from the WPS AP List section before pressing the PIN button to run the scan.

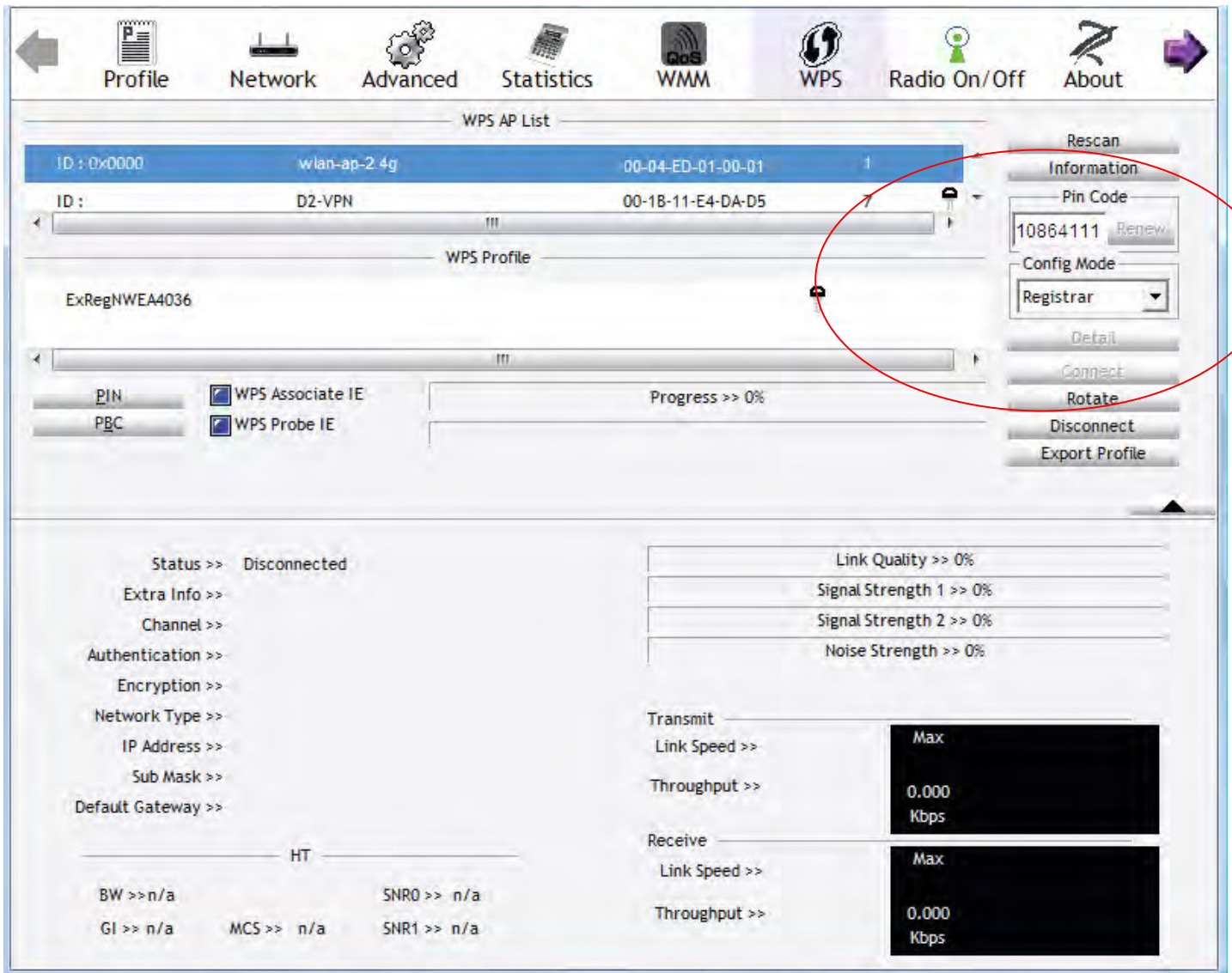

3. The router's (AP's) SSID and security setting will now be configured to match the SSID and security setting of the registrar.

The screenshot displays the WPS configuration interface of a router. At the top, there are navigation tabs: Profile, Network, Advanced, Statistics, WMM, WPS, Radio On/Off, and About. The main content area is divided into several sections:

- WPS AP List:** A table listing available APs.
 

ID :	wlan-ap-2.4g	00-04-ED-01-00-01	1
ID :	wlan-ap	00-04-ED-38-F7-2E	1
- WPS Profile List:** Shows a profile named 'ExRegNWEA4036' with a PIN of '6229909'.
- Configuration Options:** Includes checkboxes for 'WPS Associate IE' and 'WPS Probe IE', both of which are checked. A progress bar indicates 'Progress >> 100%'.
- Status Messages:** A message reads 'PIN - Get WPS profile successfully.'
- Right-Hand Panel:** Contains buttons for 'Rescan', 'Information', 'Pin Code' (with input '10864111' and a 'Renew' button), 'Config Mode' (set to 'Registrar'), 'Detail', 'Connect', 'Rotate', 'Disconnect', and 'Export Profile'.
- Connection Status Details:**
  - Status >> wlan-ap-2.4g <-> 00-04-ED-01-00-01
  - Extra Info >> Link is Up [TxPower:100%]
  - Channel >> 1 <-> 2412 MHz; central channel : 3
  - Authentication >> WPA2-PSK
  - Encryption >> AES
  - Network Type >> Infrastructure
  - IP Address >> 192.168.1.100
  - Sub Mask >> 255.255.255.0
  - Default Gateway >> 192.168.1.254
- Performance Metrics:**
  - Link Quality >> 100%
  - Signal Strength 1 >> 65%
  - Signal Strength 2 >> 39%
  - Noise Strength >> 26%
- Transmit/Receive Statistics:**
  - Transmit:** Link Speed >> 243.0 Mbps, Throughput >> 0.000 Kbps. A bar chart shows a peak of 5.392 Kbps.
  - Receive:** Link Speed >> 40.5 Mbps, Throughput >> 98.612 Kbps. A bar chart shows a peak of 118.432 Kbps.
- HT (High Throughput) Parameters:**
  - BW >> 40, SNRO >> 20
  - GI >> long, MCS >> 14, SNR1 >> n/a

4. Do Web Page refresh after ER complete AP Configuration to check the new parameters setting.

## MAC Filter



Configuration

MAC Filter

Parameters

Select SSID: wlan-ap-2.4g

MAC Restrict Mode \*:  Disable  Allow  Deny

\* If 'allow' is choosed and mac filter is empty, WPS will be disabled.

MAC Address: Remove

Add Remove

**Select SSID:** Select the SSID you want this filter applies to.

### MAC Restrict Mode:

- ① **Disable:** disable the MAC Filter function.
- ① **Allow:** allow the hosts with the following listed MACs to access the wireless network.
- ① **Deny:** deny the hosts with the following listed MACs to access the wireless network.

Click **Add** to add the MACs.



Configuration

MAC Filter

Parameters

MAC Address: << --type or select from listbox-- >>

Apply Cancel

**MAC Address:** Enter the MAC address(es) or select the MAC address(es). The format of MAC address could be: xx:xx:xx:xx:xx:xx or xx-xx-xx-xx-xx-xx.

Click **Apply** to apply your settings and the item will be listed below.



Configuration

MAC Filter

Parameters

Select SSID: wlan-ap-2.4g

MAC Restrict Mode \*:  Disable  Allow  Deny

\* If 'allow' is chosen and mac filter is empty, WPS will be disabled.

MAC Address	Remove	Edit
E0:63:E5:C5:B2:B6	<input type="checkbox"/>	Edit

Add Remove

## Wireless Bridge

WDS (wireless distributed system) is a wireless access point mode that enables wireless link and communication with other access points. It's easy to install, simply define the peer's MAC address of the connected AP. WDS takes advantage of cost saving and flexibility with no extra wireless client device required to bridge between two access points and extending an existing wired or wireless infrastructure network to create a larger network.

Here you can select what role the AP server has, AP or wireless bridge (WDS).

Configuration

### Wireless Bridge

**Parameters**  
You can select Wireless Bridge (also known as Wireless Distribution System) to disable access point functionality. Selecting Access Point enables access point functionality. Wireless bridge functionality will still be available and wireless stations will be able to associate to the AP. Select Disabled in Bridge Restrict which disables wireless bridge restriction. Any wireless bridge will be granted access. Selecting Enabled or Enabled(Scan) enables wireless bridge restriction. Only those bridges selected in Remote Bridges will be granted access.

AP Mode: Access Point

Bridge Restrict: Enable

Remote Bridges MAC Address

Apply Refresh

**AP Mode:** determines whether the gateway will act as an Access point or as a Bridge.

- ① **Access Point:** the gateway communicates with both clients and bridges.
- ① **Wireless Bridge:** the gateway communicates with other WDS devices only. In this mode, the gateway doesn't communicate with client devices.

If your wireless network includes repeaters that use WDS, the gateway in wireless bridge mode will also communicate with your repeaters. The gateway in wireless bridge mode will not communicate with a repeater that uses a proprietary (non-WDS) mode.

**Bridge Restrict:** When **AP Mode** is set to **Wireless Bridge**, this determines whether the gateway will communicate with all other bridges or only specific ones:

- ① **Enable:** to enable wireless bridge restriction. Only those specified in the Remote MAC Address the gateway can communicate with.

Bridge Restrict: Enable

Remote Bridges MAC Address

Apply Refresh

**Remote Bridge MAC Address:** enter the remote bridge MAC addresses. Here up to 4 bridge MAC addresses are supported.

- ① **Enabled (Scan):** to enable wireless bridge restriction. Only those scanned by the gateway can communicate.

Bridge Restrict: Enabled(Scan)

Remote Bridges MAC Address	SSID	BSSID
<input type="checkbox"/>	wlan-ap	00:04:ED:14:27:13

Apply Refresh

**Remote Bridge MAC Address:** select the remote bridge MAC addresses.

- ① **Disable:** Does not restrict the gateway communicating with bridges that have their MAC address listed, but it is still open to communicate with all bridges that are in the same network.

Bridge Restrict	Disable ▼
<input type="button" value="Apply"/>	<input type="button" value="Refresh"/>

Click **Apply** to apply your settings.

## Advanced

Here users can set some advanced parameters about wireless.

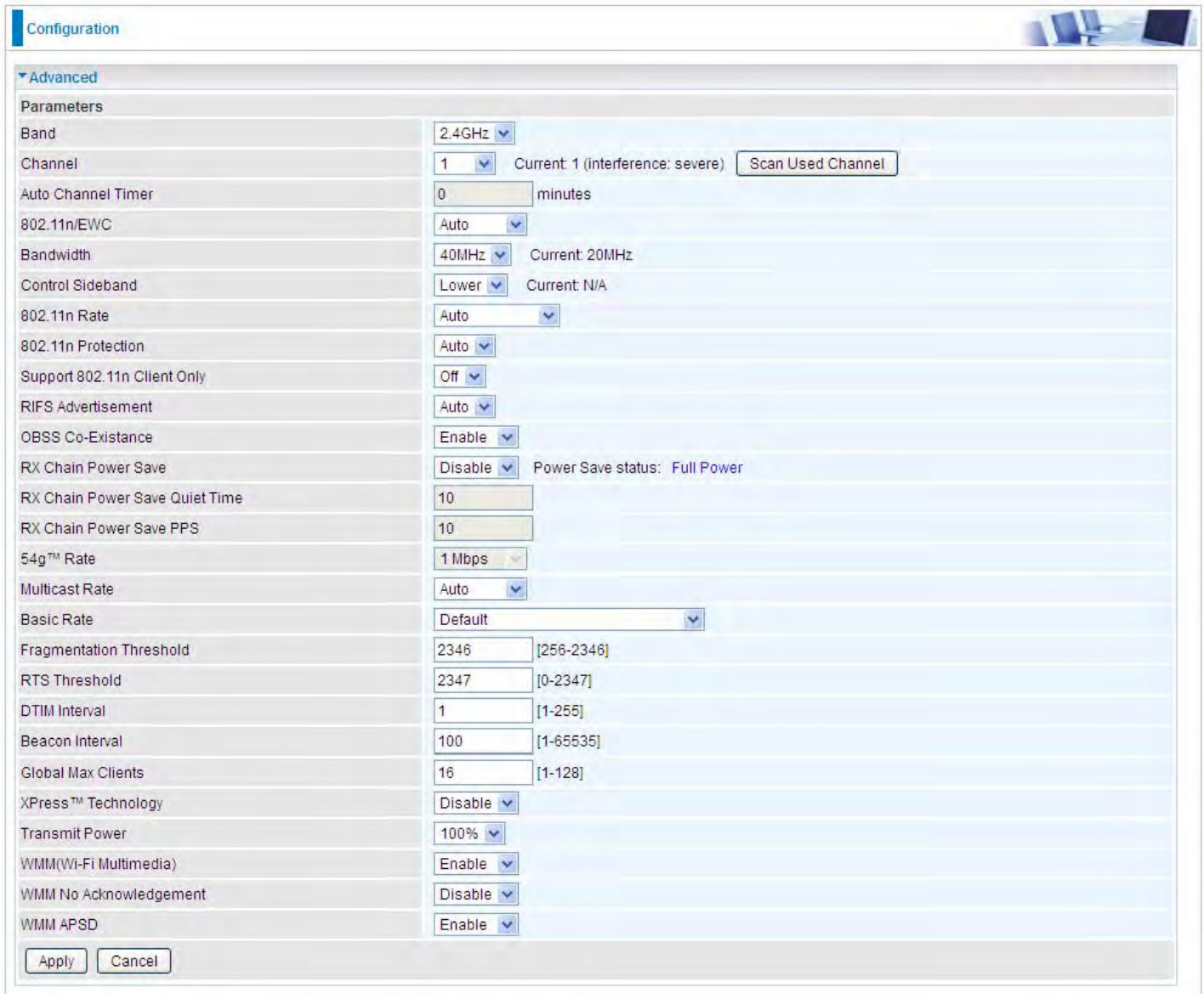

The screenshot shows a web-based configuration interface for wireless settings. The page is titled "Configuration" and has a sub-section for "Advanced". The "Parameters" section contains the following settings:

Parameter	Value	Current Value
Band	2.4GHz	
Channel	1	Current: 1 (interference: severe)
Auto Channel Timer	0 minutes	
802.11n/EWC	Auto	
Bandwidth	40MHz	Current: 20MHz
Control Sideband	Lower	Current: N/A
802.11n Rate	Auto	
802.11n Protection	Auto	
Support 802.11n Client Only	Off	
RIFS Advertisement	Auto	
OBSS Co-Existence	Enable	
RX Chain Power Save	Disable	Power Save status: Full Power
RX Chain Power Save Quiet Time	10	
RX Chain Power Save PPS	10	
54g™ Rate	1 Mbps	
Multicast Rate	Auto	
Basic Rate	Default	
Fragmentation Threshold	2346	[256-2346]
RTS Threshold	2347	[0-2347]
DTIM Interval	1	[1-255]
Beacon Interval	100	[1-65535]
Global Max Clients	16	[1-128]
XPress™ Technology	Disable	
Transmit Power	100%	
WMM(Wi-Fi Multimedia)	Enable	
WMM No Acknowledgement	Disable	
WMM APSD	Enable	

At the bottom of the configuration area, there are "Apply" and "Cancel" buttons.

**Band:** select frequency band. Here 2.4GHz.

**Channel:** Allows channel selection of a specific channel (1-7) or Auto mode.

**Scan Used Channel:** Press the button to scan and list all channels being used.

**Auto Channel Timer (min):** The auto channel times length it takes to scan in minutes. Only available for auto channel mode.

**802.11n/EWC:** select to auto enable or disable 802.11n.

**Bandwidth:** Select bandwidth. The higher the bandwidth the better the performance will be.

**Control Sideband:** only available for 40MHz. It allows you to select upper sideband or lower sideband. Sideband refers to the frequency band either above (**upper sideband**) or below (**lower sideband**) the carrier frequency, within which fall the spectral components produced by modulation of a carrier wave.

**802.11n Rate:** This allows you to select the fixed transmission rate or auto.

**802.11n Protection:** turn off for maximize throughput. Auto for greater security.

**Support 802.11n Client Only:** turn on the option to only provide wireless access to the clients operating at 802.11n speeds.



**RIFS Advertisement:** Reduced Inter-frame Spacing (RIFS) is a 802.11n feature that also improves performance by reducing the amount of dead time required between OFDM transmissions. Select Off to disable this function or auto to enable this function.

**OBSS Co-Existence:** coexistence (or not) between 20 MHz and 40 MHz overlapping basic service sets (OBSS) in wireless local area networks.

**RX Chain Power Save:** Enabling this feature turns off one of the Receive chains, going from 2x2 to 2x1 to save power.

**RX Chain Power Save Quiet Time:** The number of seconds the traffic must be below the PPS value before the Rx Chain Power Save feature activates itself.

**RX Chain Power Save PPS:** The maximum number of packets per seconds that can be processed by the WLAN interface for a duration of Quiet Time, described above, before the Rx Chain Power Save feature activates itself.

**Multicast Rate:** Setting for multicast packets transmission rate.

**Basic Rate:** Setting for basic transmission rate. It is not a specific kind of rate, it is a series of rates supported. When set to Default, the router can transmit with all kinds of standardized rates.

**Fragmentation Threshold:** A threshold (in bytes) whether the packets will be fragmented and at what size. Packets succeeding the fragmentation threshold of 802.11n WLAN will be split into smaller units suitable for circuit size. While the packets smaller than fragmentation threshold will not be fragmented. Default is 2346, setting the fragmentation too low may result in poor performance.

**RTS Threshold:** Request to Send (RTS) threshold specifies the packet size, when exceeds the size, the RTS/CTS will be triggered. The default setting of 2347(max length) will disable the RTS.

**DTIM Interval:** Delivery Traffic Indication Message (DTIM). The entry range is a value between 1 and 255. A DTIM is countdown variable that informs clients of the next window for listening to broadcast and multicast messages. When the AP has buffered broadcast or multicast messages for associated clients, it sends the next DTIM with a DTIM interval value. AP clients hear the beacons and awaken to receive the broadcast and multicast messages. The default is 1.

**Beacon Interval:** The amount of time between beacon transmissions in is milliseconds. The default is 100ms and the acceptable is 1- 65535. The beacon transmissions identify the presence of an access point.

**Global Max Clients:** Here you have the option of setting the limit of the number of clients who can connect to your wireless network.

**XPress™ Technology:** It has been designed to improve the wireless network efficiency. Default is disabled.

**Transmit Power:** select the transmitting power of your wireless signal.

**WMM (Wi-Fi Multimedia):** you can choose to enable or disable this function which allows for priority of certain data over wireless network.

**WMM No Acknowledgement:** Refers to the acknowledge policy at the MAC level. Enabling WMM No Acknowledgement can result in more efficient throughput but higher error rates in noisy Radio Frequency (RF) environment.

**WMM APSD:** Automatic Power Save Delivery. Enable this to save power.

## Station Info

Here you can view information about the wireless clients.



**MAC Address:** The MAC address of the wireless clients.

**Associated:** List all the stations that are associated with the Access Point. If a station is idle for too long, it is removed from this list

**Authorized:** List those devices with authorized access.

**SSID:** Show the current SSID of the client.

**Interface:** To show which interface the wireless client is connected to.

**Refresh:** To get the latest information.

## Schedule Control

Schedule control is aimed to offer methods to flexibly control when the wireless network (SSID) is allowed for access.

The Wireless schedule only functions whilst Wireless is enabled.

The Guest/Virtual AP schedule control only operates whilst the associated AP is enabled.

For detail setting the timeslot, user can turn to [Time Schedule](#) .

The screenshot shows the 'Configuration' page with a 'Schedule Control' section. It includes instructions: 'The Wireless schedule only functions whilst Wireless is enabled.' and 'The Guest/Virtual AP schedule control only operates whilst the associated AP is enabled.'

**wlan-ap-2.4g** is set to 'Enable'. Its 'Time Schedule' is configured as follows:

- 1. Always On (selected), Sun, Mon, Tue, Wed, Thu, Fri (checked), Sat (unchecked). From 00:00 To 00:59.
- 2. check or select from listbox, Sun, Mon, Tue, Wed, Thu, Fri, Sat (unchecked). From 00:00 To 00:00.

**w0\_Guest1** is set to 'Disable'. Its 'Time Schedule' is:

- 1. Always On (selected), Sun, Mon, Tue, Wed, Thu, Fri, Sat (unchecked). From 00:00 To 00:00.
- 2. check or select from listbox, Sun, Mon, Tue, Wed, Thu, Fri, Sat (unchecked). From 00:00 To 00:00.

**w0\_Guest2** is set to 'Disable'. Its 'Time Schedule' is:

- 1. Always On (selected), Sun, Mon, Tue, Wed, Thu, Fri, Sat (unchecked). From 00:00 To 00:00.
- 2. check or select from listbox, Sun, Mon, Tue, Wed, Thu, Fri, Sat (unchecked). From 00:00 To 00:00.

**w0\_Guest3** is set to 'Disable'. Its 'Time Schedule' is:

- 1. Always On (selected), Sun, Mon, Tue, Wed, Thu, Fri, Sat (unchecked). From 00:00 To 00:00.
- 2. check or select from listbox, Sun, Mon, Tue, Wed, Thu, Fri, Sat (unchecked). From 00:00 To 00:00.

An 'Apply' button is visible at the bottom left of the configuration area.

**Time Schedule:** Set when the SSID works. If user wants the SSID works all the time, please select "Always On"; if not, please set or select the exact time your want the SSID works. Here user can set two separate intervals.

For example: user wants the SSID "wlan-ap-2.4g" to work on weekdays except for Wednesday, under this circumstance, user can set as shown below. (7820NZ offers a optimal way to set two separate timeslots when user needs to activate the SSID during separate intervals. )

The first screenshot shows the 'Time Schedule' for 'wlan-ap-2.4g' (Enable):

- 1. check or select from listbox, Sun (unchecked), Mon, Tue (checked), Wed (unchecked), Thu, Fri, Sat (unchecked). From 00:00 To 23:59.
- 2. check or select from listbox (checked), Sun (unchecked), Mon, Tue (checked), Wed (unchecked), Thu, Fri (checked), Sat (unchecked). From 00:00 To 23:59.

The second screenshot shows the 'Time Schedule' for 'wlan-ap' (Enable):

- 1. check or select from listbox, Sun (unchecked), Mon, Tue (checked), Wed (unchecked), Thu, Fri, Sat (unchecked). From 00:00 To 23:59.
- 2. check or select from listbox (checked), Sun (unchecked), Mon, Tue (checked), Wed (unchecked), Thu, Fri (checked), Sat (unchecked). From 00:00 To 23:59.

# WAN-Wide Area Network

A WAN (Wide Area Network) is a computer network that covers a broad geographical area (eg. Internet) that is used to connect LAN and other types of network systems.

## WAN Service

Two WAN interfaces are provided for WAN connection: DSL and Ethernet.



Click **Add** to add new WAN connections.

### ① DSL

In DSL mode, there are two transfer modes for you to configure for WAN connection, namely ATM and PTM, configuration of PTM mode is similar as ATM mode, here take ATM mode WAN configuration for example.

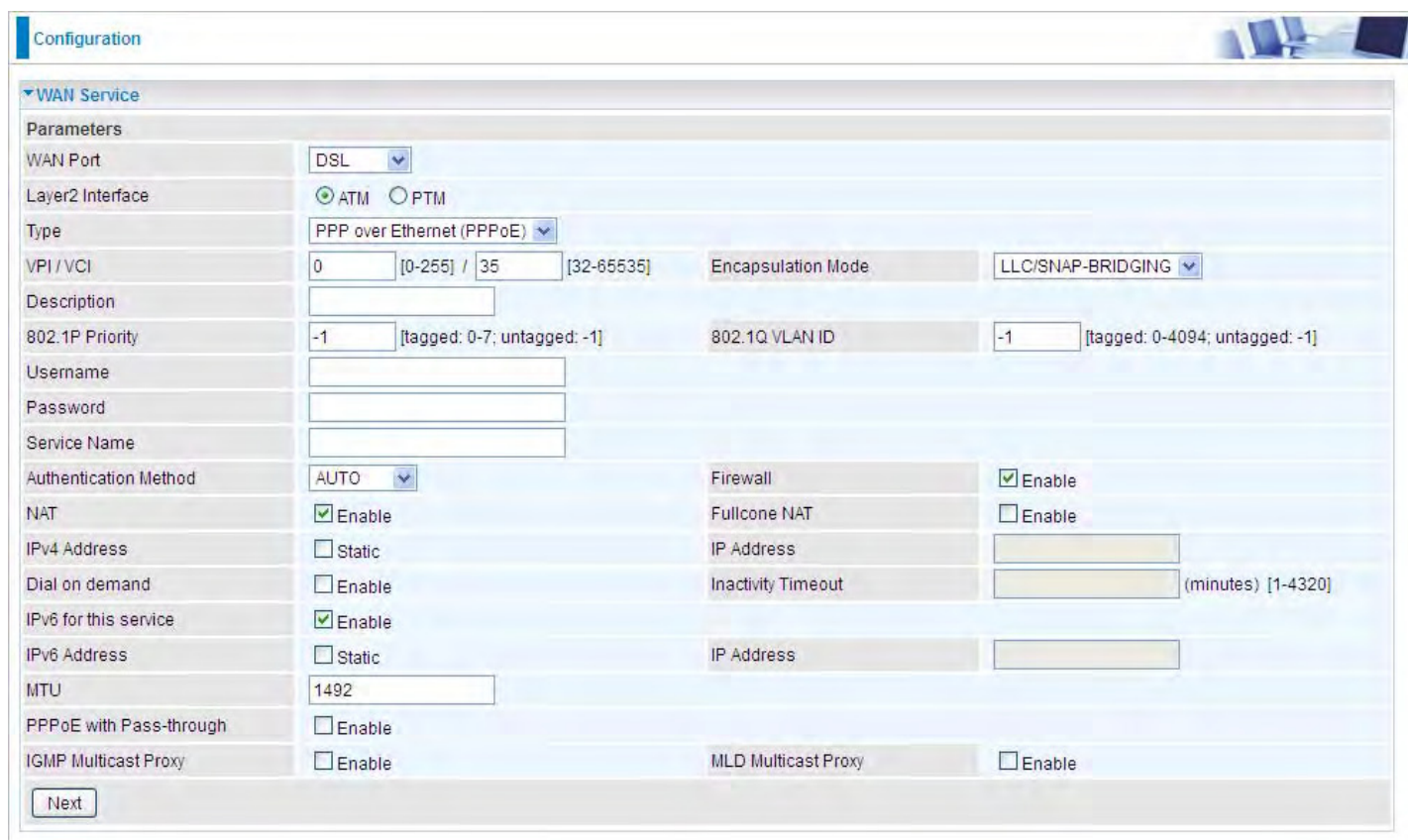

**Layer2 Interface:** 2 transfer mode, ATM or PTM.

PPPoE (PPP over Ethernet) provides access control in a manner which is similar to dial-up services using PPP.

**VCP/VPI:** Enter the VCI/VPI combination from you ISP.

**Encapsulation Mode:** Select the encapsulation mode, LLC/SNAP-BRIDGING, or VC/MUX.

**Description:** User-defined description for the connection, commonly for friendly use.

**802.1P Priority:** The parameter indicates the frame priority level from 0 (lowest) to 7 (highest), which can be used to prioritize different classes of traffic (voice, video, data, etc). Enter the priority identification, tagged: 0-7, untagged: -1.

**802.1Q VLAN ID:** It is a parameter to specify the VLAN which the frame belongs. Enter the VLAN ID identification, tagged: 0-4094, untagged : -1.

**Username:** Enter the account obtained from the ISP.

**Password:** Enter the password obtained from the ISP.

**Service Name:** The item is for identification purpose, user can define it yourselfe.

**Authentication Method:** Default is **Auto**. Or else your ISP will advise you the appropriate mode.

**Firewall:** Enable to drop all traffic from WAN side. If enabled, all incoming packets by default would be dropped, and please turn to [IP Filtering Incoming](#) to add allowing rules.

**NAT:** The NAT (Network Address Translation) feature allows multiple users to access the Internet through a single IP account by sharing the single IP address. If users on your LAN have their own public IP addresses to access the Internet, NAT function can be disabled. When enabled, a Fullcone NAT parameter will appear, you can determine whether to enable Fullcone NAT. While only NAT enabled, the default NAT type Port-Restricted cone NAT will be used.

**Fullcone NAT:** Enable or disable fullcone NAT. Fullcone is a kind of NAT, in this mode, all requests from the same internal IP address and port are mapped to the same external IP address and port. Furthermore, any external host can send a packet to the internal host by sending a packet to the mapped external address.

**Note:** In PPPoE connection, NAT is enabled by default, you can determine whether to enable Fullcone NAT or disable Fullcone NAT and only use NAT, the default NAT type is Port Restricted cone NAT. Of Port-Restricted cone NAT, the restriction includes port numbers. Specifically, an external host can send a packet, with source IP address X and source port P, to the internal host only if the internal host had previously sent a packet to IP address X and port P.

**IPv4 Address:** Select whether to set static IPv4 address or obtain automatically.

**IP Address:** If **Static** is enabled in the above field, enter the static IPv4 address get from the ISP.

**Dial on demand:** It is a parameter to let users to dial for connection to internet themselves. It is useful when saving internet fees.

**Inactivity Timeout:** The set Inactivity timeout period, unit: minutes. It is combined use with Dial on Demand, users should specify the concrete time interval for dial on demand.

**IPv6 for this service:** Enable to use IPv6 service.

**IPv6 Address:** Select whether to set static IPv6 address or obtain automatically.

**IP Address:** If **Static** is enabled in the above field, enter the static IPv4 address.

**MTU:** Maximum Transmission Unit, the size of the largest datagram (excluding media-specific headers) that IP will attempt to send through the interface.

**PPPoE with Pass-through:** Enable or disable PPPoE pass-through. If it is enabled, PCs behind the router can dial itself.

**IGMP Multicast Proxy:** Check whether to enable this feature. IGMP (**I**nternet **G**roup **M**anagement **P**rotocol) Proxy intercepts the IGMP request from Clients and set up the multicast-forwarding table, it takes over some of the router's job, simplifying the router's job and multicast communication.

**MLD Multicast Proxy:** check whether to enable this function. MLD (**M**ulticast **L**istener **D**iscovery Protocol) Proxy intercepts the MLD request from Clients a set up the multicast-forwarding table. it takes over some of the router's job, simplifying the router's job and multicast communication. Support MLDv1 and MLDv2.

Click **Next** to continue to set the default gateway and DNS for IPv4 and IPv6.

Configuration

▼ Default Gateway / DNS

**Default Gateway**

Selected Default Gateway Interfaces

pppoe\_0\_8\_35/ppp0.1

Available Routed WAN Interfaces

USB3G0

Selected WAN Interface As The System Default IPv6 Gateway

pppoe\_0\_8\_35/ppp0.1

**DNS**

DNS Server Interface

Available WAN Interfaces  Static DNS Address  Parent Controls

Selected DNS Server Interfaces

pppoe\_0\_8\_35/ppp0.1

Available WAN Interfaces

USB3G0

Primary DNS server

Secondary DNS server

Note that selecting a WAN interface for IPv6 DNS server will enable DHCPv6 Client on that interface.

DNS Server Interface

Available WAN Interfaces  Static DNS IPv6 Address

WAN Interface selected

pppoe\_0\_8\_35/ppp0.1

Primary IPv6 DNS server

Secondary IPv6 DNS server

Next

## Default Gateway

Select default gateway for you connection (IPv4 and IPv6).

## DNS

### ➤ IPv4

#### Three ways to set an IPv4 DNS server

- ① **Available WAN interfaces:** Select a desirable WAN interface as the IPv4 DNS server.
- ① **Static DNS Address:** To specify DNS server manually by entering your primary and secondary DNS server addresses.
- ① **Parental Controls:** If user registers and gets a DNS account in the parental control provider website, expecting to enjoy a more reliable and safer internet surfing environment, please select this option (need to configure at [Parental Control Provider](#)).

### ➤ IPv6

#### Obtain IPv6 DNS info from a WAN interface

**WAN Interface selected:** Select one configured IPv6 WAN connection from the menu to be as an IPv6 DNS.

#### Static DNS IPv6 Address

**Primary IPv6 DNS Server / Secondary IPv6 DNS Server:** Type the specific primary and secondary IPv6 DNS Server address.

If you don't need a service, select the item you want to remove, check the checkbox, then press **Remove**.

Press **Edit** button to re-edit this service settings.

Configuration 

▼ WAN Service

ATM Interface

Interface	Description	Type	VPI / VCI	Vlan8021p	VlanMuxId	Igmp	NAT	Firewall	IPv6	Mld	Remove	Edit
ppp0.1	pppoe_0_8_35	PPPoE	8 / 35	N/A	N/A	Disabled	Enabled	Enabled	Enabled	Disabled	<input type="checkbox"/>	Edit

3G/LTE Interface

Interface	Description	TEL No.	APN	Username	NAT	Firewall	Failover	Edit
USB3G0		*99***1#	internet		Enabled	Enabled	Enabled	Edit

Add Remove



Here you can configure WAN Service, if it is OK, you can access the internet. You can go to **Status >WAN** or **Summary** to view the WAN connection information (if your ISP provides IPv6 service, then you will obtain an IPv6 address).

**(IPv4 or IPv6)**

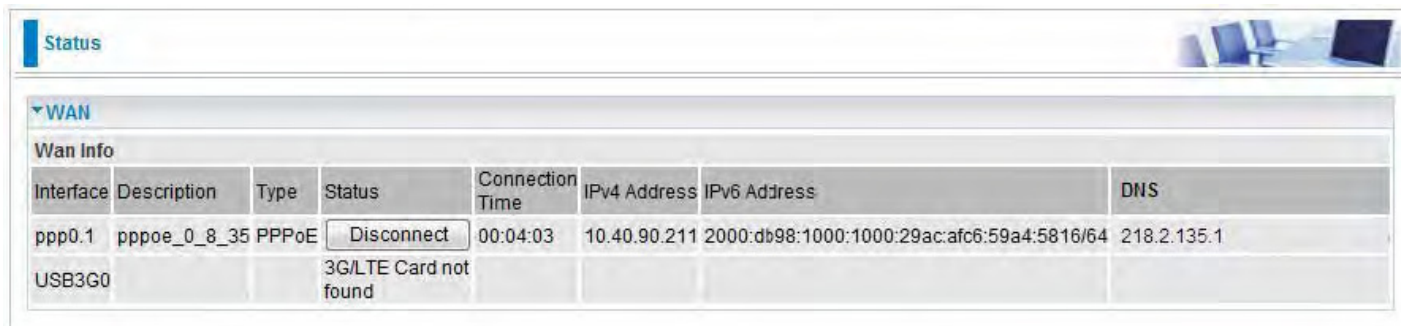

The screenshot shows a web interface with a 'Status' header. Below it, a 'WAN' section is expanded to show 'Wan Info'. A table lists two WAN interfaces: 'ppp0.1' and 'USB3G0'. The 'ppp0.1' interface is connected via PPPoE with a status of 'Disconnect', a connection time of 00:04:03, an IPv4 address of 10.40.90.211, and an IPv6 address of 2000:db98:1000:1000:29ac:afc6:59a4:5816/64. The DNS is set to 218.2.135.1. The 'USB3G0' interface is not connected because the 3G/LTE card is not found.

Interface	Description	Type	Status	Connection Time	IPv4 Address	IPv6 Address	DNS
ppp0.1	pppoe_0_8_35	PPPoE	Disconnect	00:04:03	10.40.90.211	2000:db98:1000:1000:29ac:afc6:59a4:5816/64	218.2.135.1
USB3G0			3G/LTE Card not found				

The screenshot shows a configuration window for WAN Service. The 'Parameters' section includes: WAN Port (DSL), Layer2 Interface (ATM selected), Type (PPPoA), VPI/VCI (0 / 35), Encapsulation Mode (VC/MUX), Username and Password fields, Authentication Method (AUTO), Firewall (checked), NAT (checked), Fullcone NAT (unchecked), IPv4 Address (Static unchecked), IP Address field, Dial on demand (unchecked), Inactivity Timeout field, IPv6 for this service (checked), IPv6 Address (Static unchecked), IP Address field, MTU (1500), IGMP Multicast Proxy (unchecked), and MLD Multicast Proxy (unchecked). A 'Next' button is at the bottom left.

**VCP/VPI:** Enter the VCI/VPI combination from you ISP.

**Encapsulation Mode:** Select the encapsulation mode, LLC/SNAP-BRIDGING, or VC/MUX.

**Description:** User-defined description for the connection.

**Username:** Enter the account obtained from the ISP.

**Password:** Enter the password obtained from the ISP.

**Authentication Method:** Default is **Auto**. Or else your ISP will advise you the appropriate mode.

**Firewall:** Enable to drop all traffic from WAN side. If enabled, all incoming packets by default would be dropped, and please turn to [IP Filtering Incoming](#) to add allowing rules.

**NAT:** The NAT (Network Address Translation) feature allows multiple users to access the Internet through a single IP account by sharing the single IP address. If users on your LAN have their own public IP addresses to access the Internet, NAT function can be disabled. When enabled, a Fullcone NAT parameter will appear, you can determine whether to enable Fullcone NAT. While only NAT enabled, the default NAT type Port-Restricted cone NAT will be used.

**Fullcone NAT:** Enable or disable fullcone NAT. Fullcone is a kind of NAT, in this mode, all requests from the same internal IP address and port are mapped to the same external IP address and port. Furthermore, any external host can send a packet to the internal host by sending a packet to the mapped external address.

**Note:** In this connection, NAT is enabled by default, you can determine whether to enable Fullcone NAT or disable Fullcone NAT and only use NAT, the default NAT type is Port Restricted cone NAT. With Port-Restricted cone NAT, the restriction includes port numbers. Specifically, an external host can send a packet, with source IP address X and source port P, to the internal host only if the internal host had previously sent a packet to IP address X and port P

**IPv4 Address:** Select whether to set static IPv4 address or obtain automatically.

**IP Address:** If **Static** is enabled in the above field, enter the static IPv4 address get from the ISP.

**Dial on demand:** It is a parameter to let users to dial for connection to internet themselves. It is useful when saving internet fees.

**Inactivity Timeout:** The set Inactivity timeout period, unit: minutes. It is combined use with Dial on Demand, users should specify the concrete time interval for dial on demand.

**IPv6 for this service:** Enable to use IPv6 service.

**IPv6 Address:** Select whether to set static IPv6 address or obtain automatically.

**IP Address:** If **Static** is enabled in the above field, enter the static IPv4 address.

**MTU:** Maximum Transmission Unit, the size of the largest datagram (excluding media-specific headers) that IP will attempt to send through the interface.

**IGMP Multicast Proxy:** Check whether to enable this feature. IGMP (**I**nternet **G**roup **M**anagement **P**rotocol) Proxy intercepts the IGMP request from Clients and set up the multicast-forwarding table, it takes over some of the router's job, simplifying the router's job and multicast communication.

**MLD Multicast Proxy:** check whether to enable this function. MLD (**M**ulticast **L**istener **D**iscovery **P**rotocol) Proxy intercepts the MLD request from Clients a set up the multicast-forwarding table. it takes over some of the router's job, simplifying the router's job and multicast communication. Support MLDv1 and MLDv2.

Click **Next** to continue to set the default gateway and DNS for IPv4 and IPv6.

▼ WAN Service

Parameters

WAN Port: DSL

Layer2 Interface:  ATM  PTM

Type: IP over Ethernet

VPI / VCI: 0 [0-255] / 35 [32-65535] Encapsulation Mode: LLC/SNAP-BRIDGING

Description:

802.1P Priority: -1 [tagged: 0-7; untagged: -1] 802.1Q VLAN ID: -1 [tagged: 0-4094; untagged: -1]

Obtain an IP address automatically:  Enable

Option 60 Vendor ID:

Option 61 Client ID:

Option 125:  Disable  Enable

WAN IP Address:

WAN Subnet Mask:

WAN gateway IP Address:

IPv6 for this service:  Enable

Obtain an IPv6 address automatically:  Enable

WAN IPv6 Address/Prefix Length:

WAN Next-Hop IPv6 Address:

NAT:  Enable Fullcone NAT:  Enable

Firewall:  Enable IGMP Multicast:  Enable

MLD Multicast Proxy:  Enable

MTU: 1500 MAC Spoofing:

Next

**VCP/VPI:** Enter the VCI/VPI combination from you ISP.

**Encapsulation Mode:** Select the encapsulation mode, LLC/SNAP-BRIDGING, or VC/MUX.

**Description:** User-defined description for the connection, commonly for friendly use.

**Authentication Method:** Default is **Auto**. Or else your ISP will advise you the appropriate mode.

**802.1P Priority:** The parameter indicates the frame priority level from 0 (lowest) to 7 (highest), which can be used to prioritize different classes of traffic (voice, video, data, etc). Enter the priority identification, tagged: 0-1, untagged: -1.

**802.1Q VLAN ID:** It is a parameter to specify the VLAN which the frame belongs. Enter the VLAN ID identification, tagged: 0-4094, untagged : -1.

Here two modes are supported for users to deal with the IP and DNS. You can select obtain automatically or manually input the information according to your ISP.

**Obtain an IP address automatically:** Check whether to enable this function.

**Option 60 Vendor ID:** Enter the associated information by your ISP. This option is used by DHCP clients to optionally identify the vendor type and configuration of a DHCP client. The information is a string of n octets, interpreted by servers. Vendors may choose to define specific vendor class identifiers to convey particular configuration or other identification information about a client.

**Option 61 Client ID:** Enter the associated information provided by your ISP.

**Option 125:** Option 125 is a complementary standard of DHCP protocol, it is used to encapsulate option 125 message into DHCP offer packet before forward it to clients. After the clients receive the packet, it check the option 125 field in the packet with the prestored message, if it is matched, then the client accepts this offer, otherwise it will be abandoned. Check Enable or Disable this function.

Default setting is **Disable**.

**WAN IP Address:** Enter your IPv4 address to the device provided by your ISP.

**WAN Subnet Mask:** Enter your submask to the device provided by your ISP.

**WAN gateway IP Address:** Enter your gateway IP address to the device provided by your ISP.

**IPv6 for this service:** Enable to use IPv6 service.

**Obtain an IPv6 address automatically:** check whether to enable or disable this feature.

**WAN IPv6 Address/Prefix Length:** Enter the WAN IPv6 Address/Prefix Length from your ISP.

**WAN Next-Hop IPv6 Address:** Enter the WAN Next-Hop IPv6 Address from your ISP.

**Note:** If you don't know well about the DHCP Option, you can leave it empty or leave it as default.

**NAT:** The NAT (Network Address Translation) feature allows multiple users to access the Internet through a single IP account by sharing the single IP address. If users on your LAN have their own public IP addresses to access the Internet, NAT function can be disabled. When enabled, a Fullcone NAT parameter will appear, you can determine whether to enable Fullcone NAT. While only NAT enabled, the default NAT type Port-Restricted cone NAT will be used.

**Fullcone NAT:** Enable or disable fullcone NAT. Fullcone is a kind of NAT, in this mode, all requests from the same internal IP address and port are mapped to the same external IP address and port. Furthermore, any external host can send a packet to the internal host, by sending a packet to the mapped external address.

**Firewall:** Enable to drop all traffic from WAN side. If enabled, all incoming packets by default would be dropped, and please turn to [IP Filtering Incoming](#) to add allowing rules.

**IGMP Multicast:** IGMP (**I**nternet **G**roup **M**embership Protocol) is a protocol used by IP hosts to report their multicast group memberships to any immediately neighboring multicast routers. Check this item to enable IGMP multicast on that WAN interface for multicast forwarding.

**MLD Multicast Proxy:** check whether to enable this function. MLD (**M**ulticast **L**istener **D**iscovery Protocol) Proxy intercepts the MLD request from Clients a set up the multicast-forwarding table. it takes over some of the router's job, simplifying the router's job and multicast communication. Support MLDv1 and MLDv2.

**MTU:** Maximum Transmission Unit, the size of the largest datagram (excluding media-specific headers) that IP will attempt to send through the interface.

**MAC Spoofing:** This option is required by some service providers specifying some specific MAC allowed for connecting in network. You must fill in the MAC address specified by your service provider when this information is required.

Click **Next** to continue to set the default gateway and DNS for IPv4 and IPv6.

The screenshot shows a configuration window titled 'Configuration' with a sub-section 'WAN Service'. Under 'Parameters', the following settings are visible:

- WAN Port: DSL
- Layer2 Interface: ATM (selected), PTM
- Type: IPoA
- VPI / VCI: 0 [0-255] / 35 [32-65535]
- Encapsulation Mode: LLC/SNAP-ROUTING
- Description: (empty text box)
- WAN IP Address: (empty text box)
- WAN Subnet Mask: (empty text box)
- NAT:  Enable
- Fullcone NAT:  Enable
- Firewall:  Enable
- IGMP Multicast:  Enable

A 'Next' button is located at the bottom left of the configuration area.

**VCP/VPI:** Enter the VCI/VPI combination from you ISP.

**Encapsulation Mode:** Select the encapsulation mode, LLC/SNAP-BRIDGING, or VC/MUX.

**Description:** User-defined description for the connection, commonly for friendly use.

**WAN IP:** Enter the WAN IP from the ISP.

**WAN Subnet Mask:** Enter the WAN Subnet Mask from the ISP.

**NAT:** The NAT (Network Address Translation) feature allows multiple users to access the Internet through a single IP account by sharing the single IP address. If users on your LAN have their own public IP addresses to access the Internet, NAT function can be disabled. When enabled, a Fullcone NAT parameter will appear, you can determine whether to enable Fullcone NAT. While only NAT enabled, the default NAT type Port-Restricted cone NAT will be used.

**Fullcone NAT:** Enable or disable fullcone NAT. Fullcone is a kind of NAT, in this mode, all requests from the same internal IP address and port are mapped to the same external IP address and port. Furthermore, any external host can send a packet to the internal host, by sending a packet to the mapped external address.

**Firewall:** Enable to drop all traffic from WAN side. If enabled, all incoming packets by default would be dropped, and please turn to [IP Filtering Incoming](#) to add allowing rules.

**IGMP Multicast:** IGMP (**I**nternet **G**roup **M**embership Protocol) is a protocol used by IP hosts to report their multicast group memberships to any immediately neighboring multicast routers. Check this item to enable IGMP multicast on that WAN interface for multicast forwarding.

The screenshot shows a configuration window titled 'Configuration' with a sub-section 'WAN Service'. Under 'Parameters', the following settings are visible:

- WAN Port:** DSL
- Layer2 Interface:** ATM (selected), PTM
- Type:** Bridging
- VPI/VCI:** 0 [0-255] / 35 [32-65535]
- Encapsulation Mode:** LLC/SNAP-BRIDGING
- Description:** (empty text box)
- 802.1P Priority:** -1 [tagged: 0-7; untagged: -1]
- 802.1Q VLAN ID:** -1 [tagged: 0-4094; untagged: -1]

A 'Next' button is located at the bottom left of the configuration area.

**VCP/VPI:** Enter the VCI/VPI combination from you ISP.

**Encapsulation Mode:** Select the encapsulation mode, LLC/SNAP-BRIDGING, or VC/MUX.

**Description:** User-defined description for the connection, commonly for friendly use.

**802.1P Priority:** The parameter indicates the frame priority level from 0 (lowest) to 7 (highest), which can be used to prioritize different classes of traffic (voice, video, data, etc). Enter the priority identification, tagged: 0-1, untagged: -1.

**802.1Q VLAN ID:** It is a parameter to specify the VLAN which the frame belongs. Enter the VLAN ID identification, tagged: 0-4094, untagged : -1.

## ① Ethernet

Ethernet WAN connection is well known as directly broadband WAN connection.

Configuration

WAN Service

Parameters

WAN Port: Ethernet

Type: PPP over Ethernet (PPPoE)

Description: [Empty]

802.1P Priority: -1 [tagged: 0-7; untagged: -1]      802.1Q VLAN ID: -1 [tagged: 0-4094; untagged: -1]

Username: [Empty]

Password: [Empty]

Service Name: [Empty]

Authentication Method: AUTO

NAT:  Enable

IPv4 Address:  Static

Dial on demand:  Enable

IPv6 for this service:  Enable

IPv6 Address:  Static

MTU: 1492

PPPoE with Pass-through:  Enable

IGMP Multicast Proxy:  Enable

Firewall:  Enable

Fullcone NAT:  Enable

IP Address: [Empty]

Inactivity Timeout: [Empty] (minutes) [1-4320]

IP Address: [Empty]

MLD Multicast Proxy:  Enable

Next

## ● PPPoE

Configuration

WAN Service

Parameters

WAN Port: Ethernet

Type: PPP over Ethernet (PPPoE)

Description: [Empty]

802.1P Priority: -1 [tagged: 0-7; untagged: -1]      802.1Q VLAN ID: -1 [tagged: 0-4094; untagged: -1]

Username: [Empty]

Password: [Empty]

Service Name: [Empty]

Authentication Method: AUTO

NAT:  Enable

IPv4 Address:  Static

Dial on demand:  Enable

IPv6 for this service:  Enable

IPv6 Address:  Static

MTU: 1492

PPPoE with Pass-through:  Enable

IGMP Multicast Proxy:  Enable

Firewall:  Enable

Fullcone NAT:  Enable

IP Address: [Empty]

Inactivity Timeout: [Empty] (minutes) [1-4320]

IP Address: [Empty]

MLD Multicast Proxy:  Enable

Next

**Description:** User-defined description for the connection, commonly for friendly use.

**802.1P Priority:** The parameter indicates the frame priority level from 0 (lowest) to 7 (highest), which can be used to prioritize different classes of traffic (voice, video, data, etc). Enter the priority identification, tagged: 0-1, untagged: -1.

**802.1Q VLAN ID:** It is a parameter to specify the VLAN which the frame belongs. Enter the VLAN ID



identification, tagged: 0-4094, untagged : -1.

**Username:** Enter the account obtained from the ISP.

**Password:** Enter the password obtained from the ISP.

**Service Name:** The item is for identification purpose, user can define it yourselfe.

**Authentication Method:** Default is **Auto**. Or else your ISP will advise you the appropriate mode.

**Firewall:** Enable to drop all traffic from WAN side. If enabled, all incoming packets by default would be dropped, and please turn to [IP Filtering Incoming](#) to add allowing rules.

**NAT:** The NAT (Network Address Translation) feature allows multiple users to access the Internet through a single IP account by sharing the single IP address. If users on your LAN have their own public IP addresses to access the Internet, NAT function can be disabled. When enabled, a Fullcone NAT parameter will appear, you can determine whether to enable Fullcone NAT. While only NAT enabled, the default NAT type Port-Restricted cone NAT will be used.

**Fullcone NAT:** Enable or disable fullcone NAT. Fullcone is a kind of NAT, in this mode, all requests from the same internal IP address and port are mapped to the same external IP address and port. Furthermore, any external host can send a packet to the internal host by sending a packet to the mapped external address.

**Note:** In PPPoE connection, NAT is enabled by default, you can determine whether to enable Fullcone NAT. and while you disable Fullcone NAT and only use NAT, the default NAT type is Port Restricted or Port-Restricted cone NAT, the restriction includes port numbers. Specifically, an external host can send a packet, with source IP address X and source port P, to the internal host only if the internal host had previously sent a packet to IP address X and port P

**IPv4 Address:** Select whether to set static IPv4 address or obtain automatically.

**IP Address:** If **Static** is enabled in the above field, enter the static IPv4 address get from the ISP.

**Dial on demand:** It is a parameter to let users to dial for connection to internet themselves. It is useful when saving internet fees.

**Inactivity Timeout:** The set Inactivity timeout period, unit: minutes. It is combined use with Dial on Demand, users should specify the concrete time interval for dial on demand.

**IPv6 for this service:** Enable to use IPv6 service.

**IPv6 Address:** Select whether to set static IPv6 address or obtain automatically.

**IP Address:** If **Static** is enabled in the above field, enter the static IPv4 address.

**MTU:** Maximum Transmission Unit, the size of the largest datagram (excluding media-specific headers) that IP will attempt to send through the interface.

**PPPoE with Pass-through:** Enable or disable PPPoE pass-through. If it is enabled, PCs behind the router can dial itself.

**IGMP Multicast Proxy:** Check whether to enable this feature. IGMP (**I**nternet **G**roup **M**anagement **P**rotocol) Proxy intercepts the IGMP request from Clients and set up the multicast-forwarding table, it takes over some of the router's job, simplifying the router's job and multicast communication.

**MLD Multicast Proxy:** check whether to enable this function. MLD (**M**ulticast **L**istener **D**iscovery **P**rotocol) Proxy intercepts the MLD request from Clients a set up the multicast-forwarding table. it takes over some of the router's job, simplifying the router's job and multicast communication. Support MLDv1 and MLDv2.

Click **Next** to continue to set the default gateway and DNS for IPv4 and IPv6.

The screenshot shows a configuration interface with two main sections: 'Default Gateway' and 'DNS'.  
**Default Gateway:** Under 'Selected Default Gateway Interfaces', 'ppp0.1' is listed. Under 'Available Routed WAN Interfaces', '3G0/USB3G0' is listed. A dropdown menu for 'Selected WAN Interface As The System Default IPv6 Gateway' is set to 'pppoe\_eth0/ppp0.1'.  
**DNS:** There are three radio button options: 'Available WAN Interfaces' (selected), 'Static DNS Address', and 'Parent Controls'. Under 'Selected DNS Server Interfaces', 'ppp0.1' is listed. Under 'Available WAN Interfaces', '3G0/USB3G0' is listed. Below this, there are input fields for 'Primary DNS server' and 'Secondary DNS server'. A note states: 'Note that selecting a WAN interface for IPv6 DNS server will enable DHCPv6 Client on that interface.' Below the note, there are radio button options: 'Available WAN Interfaces' (selected) and 'Static DNS IPv6 Address'. There are also input fields for 'WAN Interface selected' (set to 'pppoe\_eth0/ppp0.1'), 'Primary IPv6 DNS server', and 'Secondary IPv6 DNS server'. A 'Next' button is at the bottom left.

## Default Gateway

Select default gateway for you connection (IPv4 and IPv6).

## DNS

### ➤ IPv4

#### Three ways to set an IPv4 DNS server

- ① **Available WAN interfaces:** Select a desirable WAN interface as the IPv4 DNS server.
- ① **Static DNS Address:** To specify DNS server manually by entering your primary and secondary DNS server addresses.
- ① **Parental Controls:** If user registers and gets a DNS account in the parental control provider website, expecting to enjoy a more reliable and safer internet surfing environment, please select this option (need to configure at [Parental Control Provider](#)).

### ➤ IPv6

#### Obtain IPv6 DNS info from a WAN interface

**WAN Interface selected:** Select one configured IPv6 WAN connection from the menu to be as an IPv6 DNS.

#### Static DNS IPv6 Address

**Primary IPv6 DNS Server / Secondary IPv6 DNS Server:** Type the specific primary and secondary IPv6 DNS Server address.

If you don't need the service, select the item you want to remove, check the checkbox, then press **Remove**, it will be OK.

Press **Edit** button to re-edit this service settings.

**Configuration**

▼ WAN Service

ETH Interface

Interface	Description	Type	Vlan8021p	VlanMuxId	Igmp	NAT	Firewall	IPv6	Mld	Remove	Edit
ppp0.1	pppoe_eth0	PPPoE	N/A	N/A	Disabled	Enabled	Enabled	Enabled	Disabled	<input type="checkbox"/>	<a href="#">Edit</a>

3G/LTE Interface

Interface	Description	TEL No.	APN	Username	NAT	Firewall	Failover	Edit
USB3G0		*99***1#	internet		Enabled	Enabled	Enabled	<a href="#">Edit</a>

[Add](#) [Remove](#)

Here the corresponding WAN Service have been configured, if it is OK, you can access the internet. You can go to **Status>WAN** or **Summary** to view the WAN connection information (if your ISP provides IPv6 service, then you will obtain an IPv6 address).

**(IPv4 or IPv6)**

**Status**

▼ WAN

Wan Info

Interface	Description	Type	Status	Connection Time	IPv4 Address	IPv6 Address	DNS
ppp0.1	pppoe_eth4	PPPoE	<a href="#">Disconnect</a>	00:04:03	10.40.90.211	2000:db98:1000:1000:29ac:afc6:59a4:5816/64	218.2.135.1
USB3G0			3G/LTE Card not found				

**WAN Service**

**Parameters**

WAN Port	Ethernet		
Type	IP over Ethernet		
Description	<input type="text"/>		
802.1P Priority	-1 [tagged: 0-7; untagged: -1]	802.1Q VLAN ID	-1 [tagged: 0-4094; untagged: -1]
Obtain an IP address automatically	<input checked="" type="checkbox"/> Enable		
Option 60 Vendor ID	<input type="text"/>		
Option 61 Client ID	<input type="text"/>		
Option 125	<input checked="" type="radio"/> Disable <input type="radio"/> Enable		
WAN IP Address	<input type="text"/>		
WAN Subnet Mask	<input type="text"/>		
WAN gateway IP Address	<input type="text"/>		
IPv6 for this service	<input checked="" type="checkbox"/> Enable		
Obtain an IPv6 address automatically	<input checked="" type="checkbox"/> Enable		
WAN IPv6 Address/Prefix Length	<input type="text"/>		
WAN Next-Hop IPv6 Address	<input type="text"/>		
NAT	<input checked="" type="checkbox"/> Enable	Fullcone NAT	<input type="checkbox"/> Enable
Firewall	<input checked="" type="checkbox"/> Enable	IGMP Multicast	<input type="checkbox"/> Enable
MLD Multicast Proxy	<input type="checkbox"/> Enable		
MTU	1500	MAC Spoofing	<input type="text"/>

**Description:** User-defined description for the connection, commonly for friendly use.

**802.1P Priority:** The parameter indicates the frame priority level from 0 (lowest) to 7 (highest), which can be used to prioritize different classes of traffic (voice, video, data, etc). Enter the priority identification, tagged: 0-1, untagged: -1.

**802.1Q VLAN ID:** It is a parameter to specify the VLAN which the frame belongs. Enter the VLAN ID identification, tagged: 0-4094, untagged : -1.

Here two modes are supported for users to deal with the IP and DNS. You can select obtain automatically or manually input the information according to your ISP.

**Obtain an IP address automatically:** Check whether to enable this function.

**Option 60 Vendor ID:** Enter the associated information by your ISP. This option is used by DHCP clients to optionally identify the vendor type and configuration of a DHCP client. The information is a string of n octets, interpreted by servers. Vendors may choose to define specific vendor class identifiers to convey particular configuration or other identification information about a client.

**Option 61 Client ID:** Enter the associated information provided by your ISP.

**Option 125:** Option 125 is a complementary standard of DHCP protocol, it is used to encapsulate option 125 message into DHCP offer packet before forward it to clients. After the clients receive the packet, it check the option 125 field in the packet with the pre-stored message, if it is matched, then the client accepts this offer, otherwise it will be abandoned. Check Enable or Disable this function. Default setting is **Disable**.

**WAN IP Address:** Enter your IPv4 address to the device provided by your ISP.

**WAN Subnet Mask:** Enter your submask to the device provided by your ISP.

**WAN gateway IP Address:** Enter your gateway IP address to the device provided by your ISP.

**IPv6 for this service:** Enable to use IPv6 service.

**Obtain an IPv6 address automatically:** check whether to enable or disable this feature.

**WAN IPv6 Address/Prefix Length:** Enter the WAN IPv6 Address/Prefix Length from your ISP.

**WAN Next-Hop IPv6 Address:** Enter the WAN Next-Hop IPv6 Address from your ISP.

**Note:** If you don't know well about the DHCP Option, you can leave it empty or leave it as default.

**NAT:** The NAT (Network Address Translation) feature allows multiple users to access the Internet through a single IP account by sharing the single IP address. If users on your LAN have their own public IP addresses to access the Internet, NAT function can be disabled. When enabled, a Fullcone NAT parameter will appear, you can determine whether to enable Fullcone NAT. While only NAT enabled, the default NAT type Port-Restricted cone NAT will be used.

**Fullcone NAT:** Enable or disable fullcone NAT. Fullcone is a kind of NAT, in this mode, all requests from the same internal IP address and port are mapped to the same external IP address and port. Furthermore, any external host can send a packet to the internal host, by sending a packet to the mapped external address.

**Firewall:** Enable to drop all traffic from WAN side. If enabled, all incoming packets by default would be dropped, and please turn to [IP Filtering Incoming](#) to add allowing rules.

**IGMP Multicast:** IGMP (**I**nternet **G**roup **M**embership Protocol) is a protocol used by IP hosts to report their multicast group memberships to any immediately neighboring multicast routers. Check this item to enable IGMP multicast on that WAN interface for multicast forwarding.

**MLD Multicast Proxy:** check whether to enable this function. MLD (**M**ulticast **L**istener **D**iscovery Protocol) Proxy intercepts the MLD request from Clients a set up the multicast-forwarding table. it takes over some of the router's job, simplifying the router's job and multicast communication. Support MLDv1 and MLDv2.

**MTU:** Maximum Transmission Unit, the size of the largest datagram (excluding media-specific headers) that IP will attempt to send through the interface.

**MAC Spoofing:** This option is required by some service providers specifying some specific MAC allowed to join in network. You must fill in the MAC address specified by your service provider when this information is required.



The screenshot shows a configuration page for a WAN Service. The page is titled "Configuration" and has a "WAN Service" section expanded. Under "Parameters", the following fields are visible:

WAN Port	Ethernet
Type	Bridging
Description	
802.1P Priority	-1 [tagged: 0-7; untagged: -1]
802.1Q VLAN ID	-1 [tagged: 0-4094; untagged: -1]

A "Next" button is located at the bottom left of the configuration area.

**Description:** User-defined description for the connection, commonly for friendly use.

**802.1P Priority:** The parameter indicates the frame priority level from 0 (lowest) to 7 (highest), which can be used to prioritize different classes of traffic (voice, video, data, etc). Enter the priority identification, tagged: 0-1, untagged: -1.

**802.1Q VLAN ID:** It is a parameter to specify the VLAN which the frame belongs. Enter the VLAN ID identification, tagged: 0-4094, untagged : -1.

## ① 3G/LTE

Select 3G/LTE to configure the route to enjoy the mobility. Given that BiPAC 7820NZ supports dual - SIM mobile connectivity, please determine which SIM you are gonna use or both (3G/LTE failover), and set the exact required connecting information for each SIM (SIM1 and SIM2). By default the 3G/LTE interface is on, user can edit the parameters to meet your own requirements.

Configuration

---

**WAN Service**

**ATM Interface**

Interface	Description	Type	VPI / VCI	Vlan8021p	VlanMuxId	Igmp	NAT	Firewall	IPv6	Mld	Remove	Edit
ppp0.1	pppoe_0_8_35	PPPoE	8 / 35	N/A	N/A	Disabled	Enabled	Enabled	Enabled	Disabled	<input type="checkbox"/>	<a href="#">Edit</a>

**3G/LTE Interface**

Interface	Description	TEL No.	APN	Username	NAT	Firewall	Failover	Edit
USB3G0		*99***1#	internet		Enabled	Enabled	Enabled	<a href="#">Edit</a>

[Add](#) [Remove](#)

Click **Edit** button to enter the 3G/LTE configuration page.

Configuration

WAN Service

Parameters

Dial on demand  Enable

SIM 1 (Current)

Mode UMTS 3G preferred

Use PPP  Enable

TEL No. \*99\*\*\*1# APN internet

Username Password

Authentication Method AUTO PIN

Dial on demand  Enable

Keep Alive  Enable 7 seconds [1-86400]

IP Address 8.8.8.8

MTU 1500

SIM 2

Mode UMTS 3G preferred

Use PPP  Enable

TEL No. \*99\*\*\*1# APN internet

Username Password

Authentication Method AUTO PIN

Dial on demand  Enable

Keep Alive  Enable 7 seconds [1-86400]

IP Address 8.8.8.8

MTU 1500

SIM 2

Mode UMTS 3G preferred

Use PPP

TEL No. \*99\*\*\*1# APN internet

Username Password

Authentication Method AUTO PIN

Dial on demand  Enable

Keep Alive  Enable 7 seconds [1-86400]

IP Address 8.8.8.8

MTU 1500

NAT  Enable Firewall  Enable

Selected Default Gateway Interfaces Available Routed WAN Interfaces

USB3G0 eth3.1  
ppp0.1

Obtain DNS  Use WAN Interface  Use Static DNS  Parent Controls

Selected DNS Server Interfaces Available WAN Interfaces

USB3G0 ppp0.1  
eth3.1

Primary DNS Secondary DNS

\*Warning: Entering the wrong PIN code three times will lock the SIM.

Apply Cancel

**Dial on demand:** If enabled, the 3G/LTE will work in dial on demand and be brought up only when there is no active default route. In this mode, 3G/LTE work as a backup for the WAN connectivity. While if disabled, 3G/LTE serves as a normal interface, and can only be brought up when it has



been configured to achieve a mobile connectivity.

## SIM 1 & SIM 2

**Mode:** There are 6 options of phone service standards: GSM 2G only, UMTS 3G only, GSM 2G preferred, UMTS 3G preferred, Automatic, and LTE only. If you are uncertain what services are available to you, and then please select Automatic.

**Use PPP:** Check to use PPP.

**TEL No.:** The dial string to make a 3G/LTE user interneting call. It may provide by your mobile service provider.

**APN:** An APN is similar to a URL on the WWW, it is what the unit makes a GPRS / UMTS call. The service provider is able to attach anything to an APN to create a data connection, requirements for APNs varies between different service providers. Most service providers have an internet portal which they use to connect to a DHCP Server, thus giving you access to the internet i.e. some 3G operators use the APN 'internet' for their portal. The default value is "internet".

**Username/Password:** Enter the username and password provided by your service provider. The username and password are case sensitive.

**Authentication Method:** Default is Auto. Please consult your service provider on whether to use PAP, CHAP or MSCHAP.

**PIN:** PIN stands for Personal Identification Number. A PIN code is a numeric value used in certain systems as a password to gain access, and authenticate. In mobile phones a PIN code locks the SIM card until you enter the correct code. If you enter the PIN code incorrectly into the phone 3 times in a row, then the SIM card will be blocked and you will require a PUK code from your network/service provider.

- ① **Connect on Demand:** If you want to make UMTS/GPRS call only when there is a packet requesting access to the Internet (i.e. when a program on your computer attempts to access the Internet). In this mode, you must set Idle Timeout value at same time. Click on Connect on Demand, the Idle Timeout field will display.

**Idle Timeout:** Auto-disconnect the broadband firewall gateway when there is no activity on the line for a predetermined period of time. Default is 600 seconds.

Dial on demand	<input checked="" type="checkbox"/> Enable
Idle Timeout	<input type="text" value="600"/> seconds [10-86400]

- ① **Keep Alive:** Check Enable to allow the router to check the mobile connectivity every 7 (can be changed based on need) seconds by ping the IP address set below the keep the 3G/LTE link active.

**IP Address:** The IP address is used to "ping", and router will ping the IP to find whether the connection is still on.

Dial on demand	<input type="checkbox"/> Enable
Keep Alive	<input checked="" type="checkbox"/> Enable <input type="text" value="7"/> seconds [1-86400]
IP Address	<input type="text" value="8.8.8.8"/>

**NAT:** Check to enable the NAT function.

**Firewall:** Enable to drop all traffic from WAN side. If enabled, all incoming packets by default would be dropped, and please turn to [IP Filtering Incoming](#) to add allowing rules.

**MTU:** MTU (Maximum Transmission Unit) is the size of the largest datagram that IP will attempt to

send through the interface.

**Selected default gateway interfaces:** Select from the interfaces the default gateway, here commonly we select USB3G0.

**Selected DNS Server Interfaces:** Three ways to set a DNS server.

- ① **Available WAN interfaces:** Select a desirable WAN interface as the DNS server.
- ① **Static DNS Address:** To specify DNS server manually by entering your primary and secondary DNS server addresses.
- ① **Parental Controls:** If user registers and gets a DNS account in the parental control provider website, expecting to enjoy a more reliable and safer internet surfing environment, please select this option (need to configure at [Parental Control Provider](#)).

Click **Apply** to confirm the settings.

Here you can configure WAN Service, if it is OK, you can access the internet. You can go to **Status >WAN** or **Summary** to view the WAN connection information (Here user can see the 3G/LTE failover).

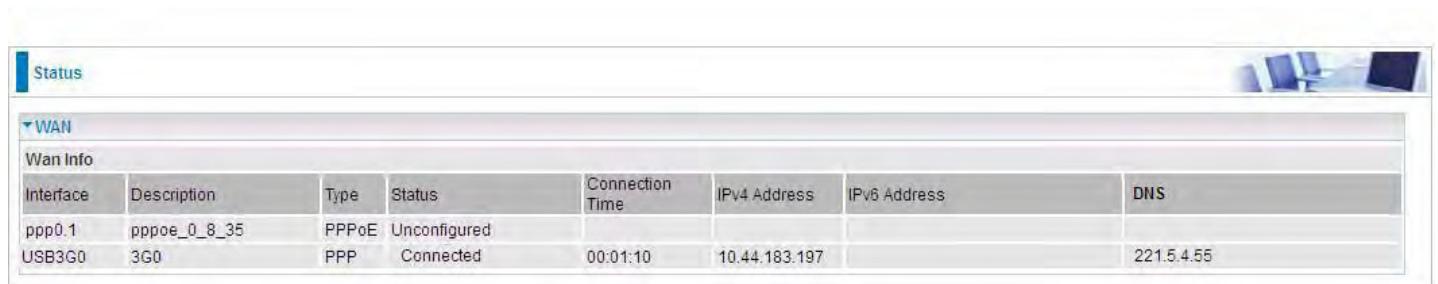

The screenshot shows a web interface with a 'Status' tab selected. Underneath, there is a 'WAN' section with a 'Wan Info' table. The table has columns for Interface, Description, Type, Status, Connection Time, IPv4 Address, IPv6 Address, and DNS. Two rows are visible: one for 'ppp0.1' which is 'Unconfigured', and one for 'USB3G0' which is 'Connected' with an IPv4 address of '10.44.183.197' and a DNS of '221.5.4.55'.

Interface	Description	Type	Status	Connection Time	IPv4 Address	IPv6 Address	DNS
ppp0.1	pppoe_0_8_35	PPPoE	Unconfigured				
USB3G0	3G0	PPP	Connected	00:01:10	10.44.183.197		221.5.4.55

## Failover

Auto failover/failback is to ensure an always-on internet connection. Users can set a Master WAN interface (main WAN) and a slave interface (backup WAN), and when Master WAN fails, it will switch to slave WAN, and when master WAN restores, it will switch to master WAN interface again.



The screenshot shows the 'Configuration' page for L3 WAN Failover. The 'Failover' section is expanded, showing the following settings:

- L3 WAN Failover:**  Enable  Disable
- Master Interface:** pppoe\_0\_8\_35/ppp0.1 (Ping: Gateway selected)
- Slave Interface:** pppoe\_0\_8\_35/ppp0.1 (Ping: Gateway selected)
- Probe Cycle:** 30 seconds [3~86400]
- Connectivity Decision:** Fail after 3 times [1~32]
- Fall back:**

Buttons for 'Apply' and 'Cancel' are visible at the bottom.

**L3 WAN Failover:** Check Enable to activate L3 WAN failover.

**Master Interface:** Select a master WAN interface.

**Ping:** To ping to check the master WAN interface's connectivity.

- ① **Gateway:** It will send ping packets to gateway of master interface and wait for response from it in every "Probe Cycle" to check the connectivity of the gateway of master interface.
- ① **Host:** It will send ping packets to specific host and wait for response in every "Probe Cycle".

**Slave Interface:** Select a slave WAN interface as backup port.

**Ping:** To ping to check the slave WAN interface's connectivity.

- ① **Gateway:** It will send ping packets to gateway of slave interface and wait for response from it in every "Probe Cycle" to check the connectivity of the gateway of slave interface.
- ① **Host:** It will send ping packets to specific host and wait for response in every "Probe Cycle".

**Probe Cycle:** Set the time duration for the **Probe Cycle** to determine when the router will switch to the backup connection once the main connection (main port) fails. For example, when set to 30 seconds, the probe will be conducted every 30 seconds.

**Connectivity Decision:** Set how many times of probing failure to switch to backup port.

### Note:

1) The time set is for each probe cycle, but the decision to change to the backup port is determined by **Probe Cycle** multiplied by **connection Decision amount** (e.g. From the image above it will be 30 seconds multiplied by 3 consecutive fails, the router will determine failover to slave interface.

2).The failback setting follow the same decision policy as the failover. For example, according to settings above in the screenshot, the connection probe will be carried out every 30 seconds, and 3 consecutive times of probe success is found, the router will determine failback to master interface.

## Dual SIM

BiPAC 7820NZ offers dual-SIM slots for two mobile SIM cards. The SIM 1 will be in use when two SIM cards are both up. The current SIM connection will fail over to the other SIM connection when the situation below happens. But note when the failover is done, the connection cannot fail back to the previous SIM connection.

The screenshot shows a configuration window titled 'Configuration' with a sub-section for 'Dual SIM'. Under 'Parameters', the 'Failover' checkbox is checked. The 'Connectivity Decision' is set to 5 consecutive times. The 'Failover Probe Cycle' is set to 12 seconds. Under 'Detect Rule', the 'SIM Lost' radio button is selected, and the 'Ping Host Fail' option is disabled. There are 'Apply' and 'Cancel' buttons at the bottom.

**Failover:** Check Enable to activate failover feature.

**Connectivity Decision:** Set how many times of probing failure to switch to the other SIM.

**Failover Probe Cycle:** Set the time duration for the Probe Cycle to determine when the router will switch to the other SIM once the current SIM connection fails. For example, when set to 12 seconds, the probe will be conducted every 12 seconds.

**Detect Rule:** Choose the probe policy, to Ping Host or when SIM lost

- ① **SIM Lost:** SIM card absent or not be able to establish connection.
- ① **Ping Host Fail:** It will send ping packets to host pre-set, and wait for response from it in every "Probe Cycle" to check the connectivity to the mail SIM.

### Note:

The time set is for each probe cycle, but the decision to change to the other SIM is determined by Probe Cycle multiplied by connection Decision amount (e.g. From the image above it will be 12 seconds multiplied by 5 consecutive fails, the router will determine failover to another SIM).

## DSL

This screen allows you to set DSL parameters. DSL knowledge is required to configure these settings. Contact your ISP to make sure that these parameters are correct.

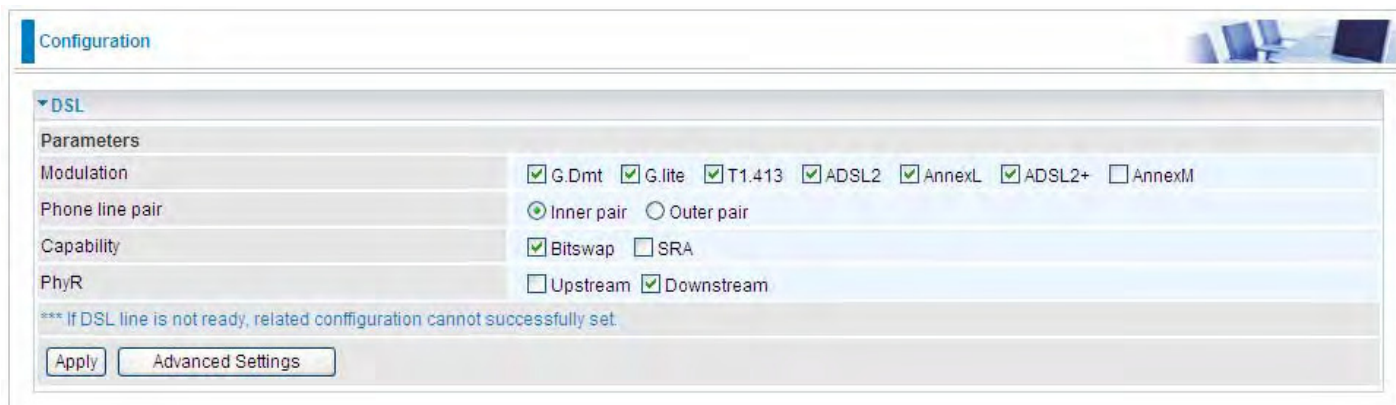

The screenshot shows a web interface for DSL configuration. At the top, there is a 'Configuration' header. Below it, a section titled 'DSL' is expanded. Under 'Parameters', the following settings are visible:

- Modulation:**  G.Dmt,  G.lite,  T1.413,  ADSL2,  AnnexL,  ADSL2+,  AnnexM
- Phone line pair:**  Inner pair,  Outer pair
- Capability:**  Bitswap,  SRA
- PhyR:**  Upstream,  Downstream

Below the settings, a warning message reads: "\*\*\* If DSL line is not ready, related configuration cannot successfully set." At the bottom of the configuration area, there are two buttons: 'Apply' and 'Advanced Settings'.

**Modulation:** There are 7 modes “G.Dmt”, “G.lite”, “T1.413”, “ADSL2”, “AnnexL”, “ADSL2+”, “AnnexM” that user can select for this connection.

**Phone line pair:** This is for reserved only. You can choose "Inner Pair" or "Outer Pair".

**Capability:** There are 2 options “Bitswap Enable” and “SRA Enable” that user can select for this connection.

① Bitswap Enable: Allows bitswaping function.

① SRA Enable: Allows seamless rate adaptation.

**PhyR:** A new technology to control impulse and noise to improve the BER and DSL data quality.

Click **Apply** to confirm the settings.

Click  to future configure DSL.



The screenshot shows the 'DSL Advanced Settings' section of the configuration interface. Under 'Parameters', the 'Test Mode' is set to 'Normal'. The other options are 'Reverb', 'Medley', 'No Retrain', and 'L3'. At the bottom, there are two buttons: 'Apply' and 'Tone Selection'.

Select the Test Mode, or leave it as default.

**Tone Selection:** This should be left as default or be configured by an advanced user.

The frequency band of ADSL is split up into 256 separate tones, each spaced 4.3125 kHz apart.

With each tone carrying separate data, the technique operates as if 256 separate modems were running in parallel. The tone range is from 0 to 31 for upstream and from 32 to 255 for downstream.

## SNR

**Signal-to-noise ratio** (often abbreviated **SNR** or **S/N**) is a measure used in science and engineering that compares the level of a desired signal to the level of background noise. It is defined as the ratio of signal power to the noise power.

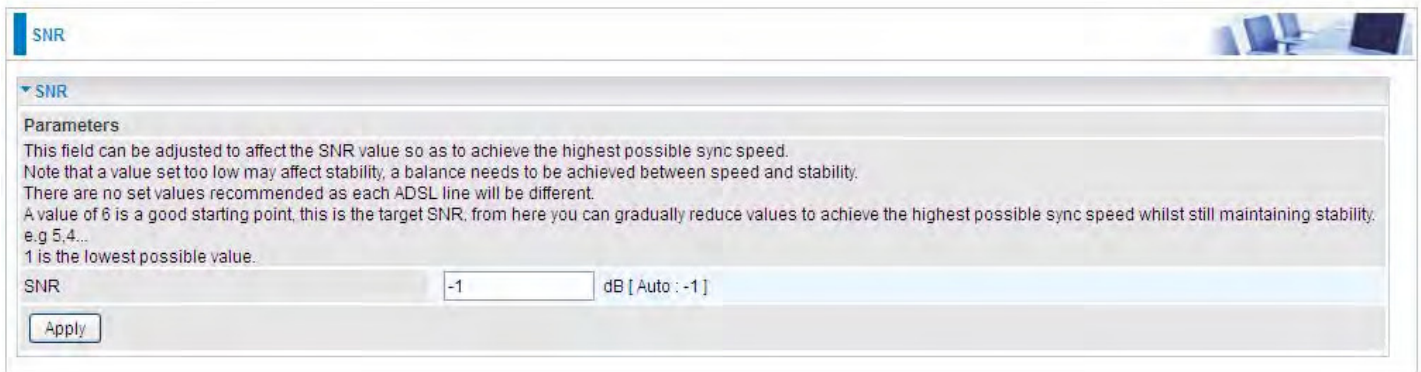

The screenshot shows a web-based configuration interface for SNR. At the top left, there is a blue header with the text "SNR". Below this, a dropdown menu is set to "SNR". Underneath, a section titled "Parameters" contains the following text: "This field can be adjusted to affect the SNR value so as to achieve the highest possible sync speed. Note that a value set too low may affect stability, a balance needs to be achieved between speed and stability. There are no set values recommended as each ADSL line will be different. A value of 6 is a good starting point, this is the target SNR, from here you can gradually reduce values to achieve the highest possible sync speed whilst still maintaining stability. e.g 5,4... 1 is the lowest possible value." Below the text is a text input field labeled "SNR" containing the value "-1", followed by the unit "dB [ Auto : -1 ]". At the bottom left of the configuration area is an "Apply" button.

**SNR:** Change the value to adjust the DSL link rate, more suitable for an advanced user.

# System

## Internet Time

The router does not have a real time clock on board; instead, it uses the Network Time Protocol (NTP) to get the most current time from an NTP server.

NTP is a protocol for synchronization of computers. It can enable computers synchronize to the NTP server or clock source with a high accuracy.

Configuration

Internet Time

Parameters

Synchronize with Internet time servers  Enable

First NTP time server	Other	192.43.244.18
Second NTP time server	Other	128.138.140.44
Third NTP time server	Other	129.6.15.29
Fourth NTP time server	Other	131.107.1.10
Fifth NTP time server	None	

Time zone offset: (GMT-00:00) Greenwich Mean Time: Dublin, Edinburgh, Lisbon, London

Apply Cancel

Choose the NTP time server from the drop-down menu, if you prefer to specify an NTP server other than those in the drop-down list, simply enter its IP address in their appropriate blanks provided as shown above. Your ISP may also provide an SNTP server for you to use.

Choose your local time zone from the drop-down menu. After a successful connection to the Internet, the router will retrieve the correct local time from the NTP server you have specified. If you prefer to specify an NTP server other than those in the drop-down list, simply enter its IP address in their appropriate blanks provided as shown above. Your ISP may also provide an NTP server for you to use.

Click **Apply** to apply your settings.



## Firmware Upgrade

Software upgrading lets you experience new and integral functions of your router.

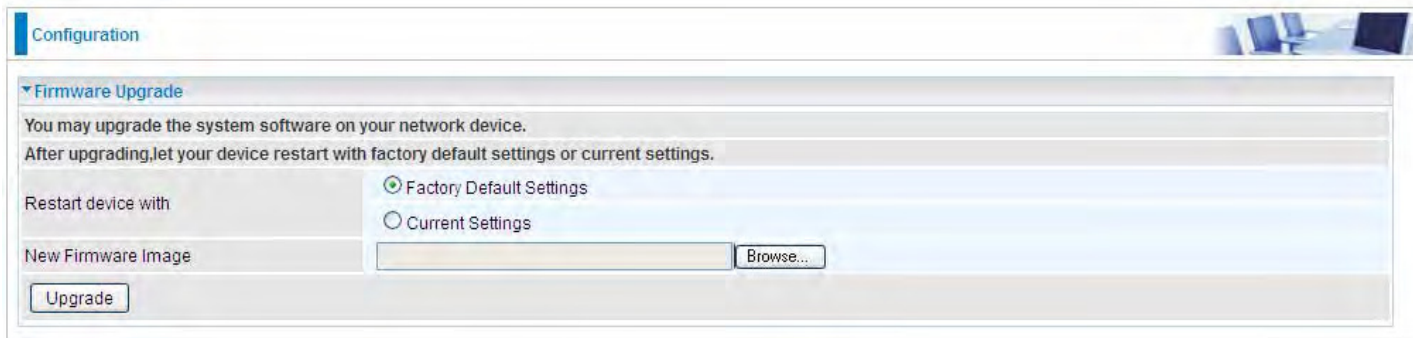

The screenshot shows the 'Configuration' page with a 'Firmware Upgrade' section. It contains the following text and controls:

- Configuration
- Firmware Upgrade
- You may upgrade the system software on your network device.
- After upgrading, let your device restart with factory default settings or current settings.
- Restart device with:
  - Factory Default Settings
  - Current Settings
- New Firmware Image: [Text Field] [Browse...]
- [Upgrade]

### Restart device with:

- ① **Factory Default Settings:** Restart the device with factory default settings automatically when finishing upgrading.
- ① **Current Settings:** Restart the device with the current settings automatically when finishing upgrading.

Your router's "firmware" is the software that allows it to operate and provides all its functionality.

Think of your router as a dedicated computer, and the firmware as the software it runs. Over time this software may be improved and revised, and your router allows you to upgrade the software it runs to take advantage of these changes.

Clicking on **Browse** will allow you to select the new firmware image file you have downloaded to your PC. Once the correct file is selected, click **Upgrade** to update the firmware in your router.



### Warning

DO NOT power down the router or interrupt the firmware upgrading while it is still in process. Improper operation could damage the router.

## Backup / Update

These functions allow you to save and backup your router's current settings to a file on your PC, or to restore from a previously saved backup. This is useful if you wish to experiment with different settings, knowing that you have a backup handy in the case of any mistakes. It is advisable to backup your router's settings before making any significant changes to your router's configuration.

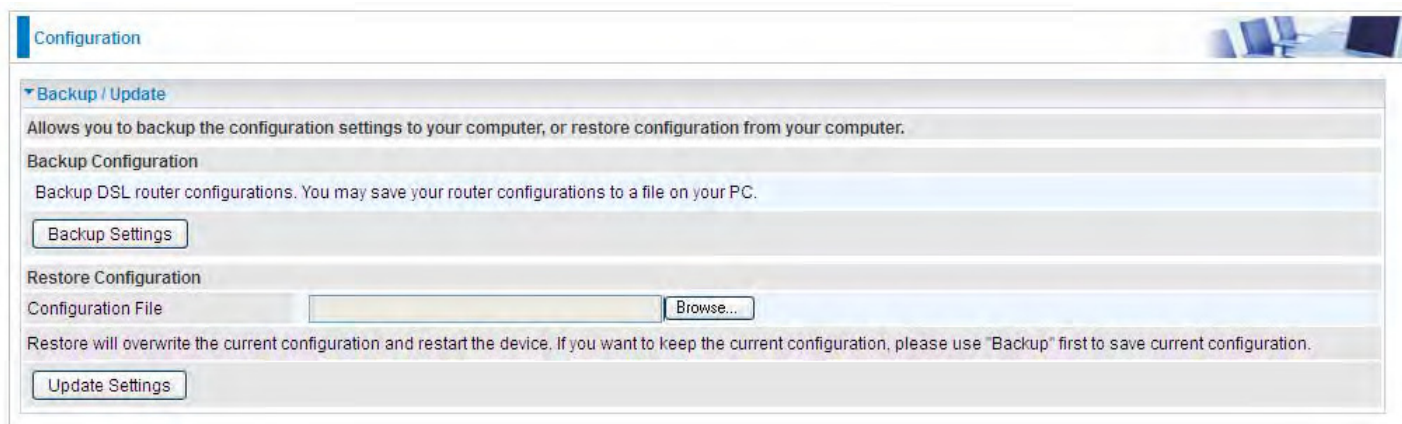

The screenshot shows the 'Configuration' page with a sub-section titled 'Backup / Update'. It contains the following elements:

- A header bar with the text 'Configuration' and a small image of a laptop.
- A dropdown menu showing 'Backup / Update'.
- A descriptive text: 'Allows you to backup the configuration settings to your computer, or restore configuration from your computer.'
- A section titled 'Backup Configuration' with the text: 'Backup DSL router configurations. You may save your router configurations to a file on your PC.'
- A button labeled 'Backup Settings'.
- A section titled 'Restore Configuration'.
- A text input field for 'Configuration File' followed by a 'Browse...' button.
- A warning text: 'Restore will overwrite the current configuration and restart the device. If you want to keep the current configuration, please use "Backup" first to save current configuration.'
- A button labeled 'Update Settings'.

Click **Backup Settings**, a window appears, click save, then browse the location where you want to save the backup file.

Click **Browse** and browse to the location where your backup file is saved, then click **Open**. Then in the above page, click **Update Settings**, the following process indicating screen will appear. Let it update to 100%, it will automatically turn to the Device Info page.

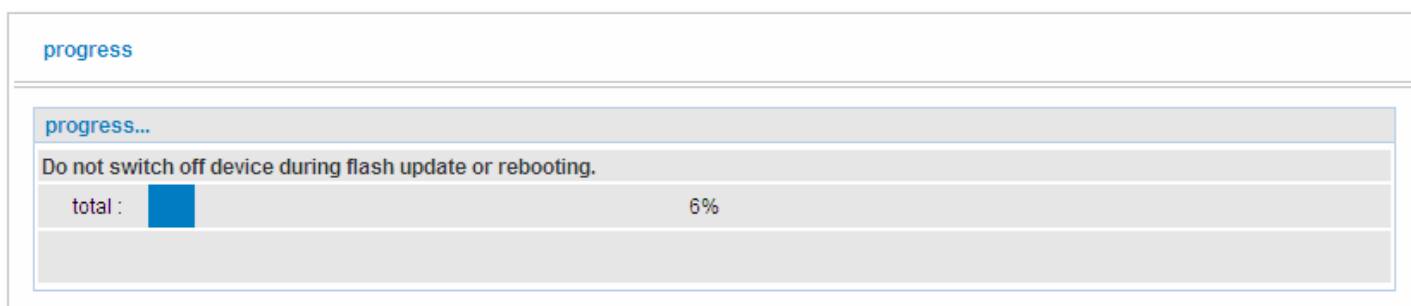

The screenshot shows a 'progress' screen with the following elements:

- A header bar with the text 'progress'.
- A sub-section titled 'progress...'. Below it is a warning: 'Do not switch off device during flash update or rebooting.'
- A progress bar showing 'total :' followed by a blue bar and the text '6%'.

## Access Control

Access Control is used to prevent unauthorized access to the router configuration page. Here you can change the login user password. Three user levels are provided here. Each user level there's a default provided user. You must access the router with the appropriate username and password. Here the corresponding passwords are allowed to change.

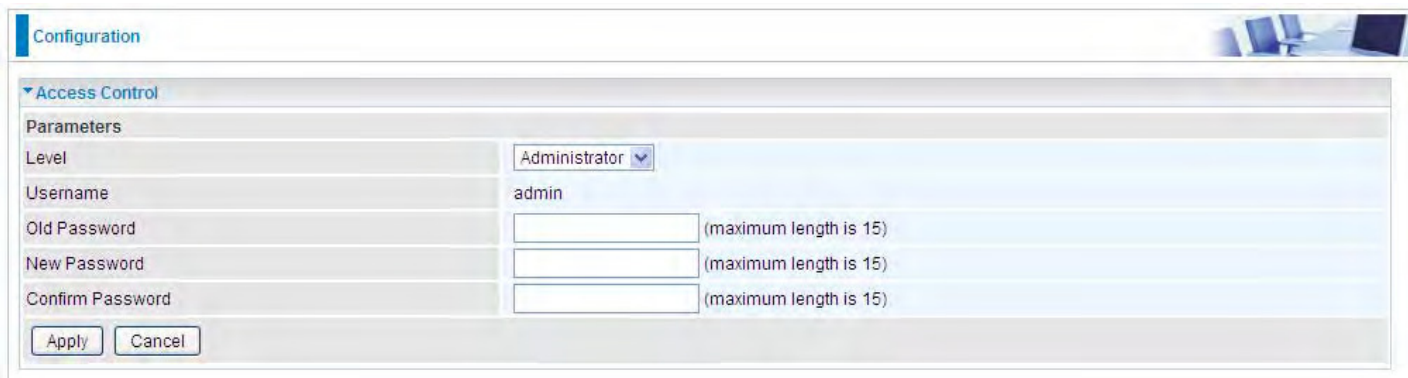

The screenshot shows the 'Configuration' page with the 'Access Control' section expanded. Under 'Parameters', the 'Level' is set to 'Administrator'. The 'Username' is 'admin'. There are three password fields: 'Old Password', 'New Password', and 'Confirm Password', each with a note '(maximum length is 15)'. At the bottom are 'Apply' and 'Cancel' buttons.

**Level:** select which level you want to change password to. There are three default levels.

- ① **Administrator:** the root user, corresponding default username and password are admin and admin respectively.
- ① **Remote:** username for the remote user to login, corresponding default username and password are support and support respectively.
- ① **Local:** username for the general user, when logon to the web page, only lit items would be listed for common user, corresponding default username password are user and user respectively.

**Username:** the default username for each user level.

**Old Password:** Enter the old password.

**New Password:** Enter the new password.

**Confirm Password:** Enter again the new password to confirm.

**Note:** By default the accounts of **Remote** and **Local** are disabled, please click **Valid** check-box to activate the accounts.

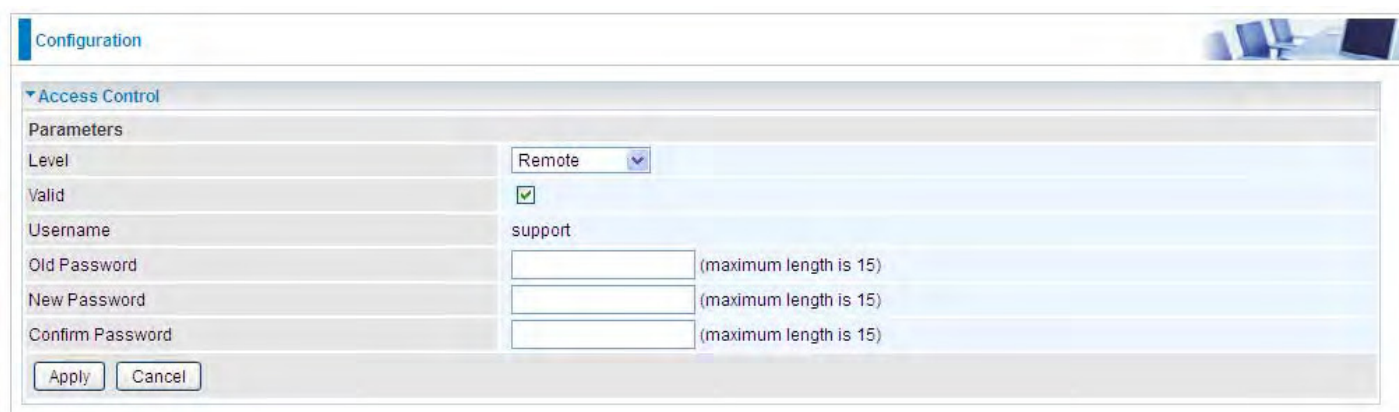

The screenshot shows the 'Configuration' page with the 'Access Control' section expanded. Under 'Parameters', the 'Level' is set to 'Remote'. The 'Valid' checkbox is checked. The 'Username' is 'support'. There are three password fields: 'Old Password', 'New Password', and 'Confirm Password', each with a note '(maximum length is 15)'. At the bottom are 'Apply' and 'Cancel' buttons.

Click **Apply** to apply your new settings.

## Mail Alert

Mail alert is designed to keep system administrator or other relevant personnel alerted of any unexpected events that might have occurred to the network computers or server for monitoring efficiency. With this alert system, appropriate solutions may be tackled to fix problems that may have arisen so that the server can be properly maintained.

Configuration

▼ Mail Alert

Server Information

WAN Port: DSL

Apply all the settings to:  Ethernet  3G/LTE

SMTP Server: [ ]

Username: [ ]

Password: [ ]

Sender's E-mail: [ ] (Must be xxx@yyy.zzz)

SSL / TLS:  Enable

Port: 25

Account Test

Failover / Failback

Recipient's E-mail: [ ] (Must be xxx@yyy.zzz)

WAN IP Change Alert

Recipient's E-mail: [ ] (Must be xxx@yyy.zzz)

3G/LTE Usage Allowance

Recipient's E-mail: [ ] (Must be xxx@yyy.zzz)

SIM lost

Recipient's E-mail: [ ] (Must be xxx@yyy.zzz)

Apply Cancel

**WAN Port:** Mail Alert feature can be applicable to every WAN mode: Ethernet, DSL and 3G/LTE. Select the port you want to use Mail Alert.

For example DSL, then when the WAN connection is in DSL mode and when there is any unexpected event, the alert message will be sent to your specified E-mail.

**Apply all settings to:** check whether you want to have a copy of the settings to apply to other WAN port, suppose the above Main port is DSL, then if you enable this function, then Ethernet port will have the same configuration.

**SMTP Server:** Enter the SMTP server that you would like to use for sending emails.

**Username:** Enter the username of your email account to be used by the SMTP server.

**Password:** Enter the password of your email account.

**Sender's Email:** Enter your email address.

**SSL:** check to whether to enable SSL encryption feature.

**Port:** the port, default is 25.

**Account Test:** Press this button to test the connectivity and feasibility to your sender's e-mail.

**Recipient's Email (WAN IP Change Alert):** Enter the email address that will receive the alert message once a WAN IP change has been detected.

**Recipient's Email (3G/LTE Usage Allowance):** Enter the email address that will receive the alert message once the 3G over Usage Allowance occurs.

**Recipient's Email (SIM lost):** Enter the email address that will receive the alert message once the SIM card loss has been detected.

## SMS Alert

SMS, Short Message Service, is to inform clients the information clients subscribe. The BiPAC 7820NZ offers SMS alert sending clients alert messages when a WAN IP change is detected.



The screenshot shows a web interface for configuring SMS alerts. At the top, there is a 'Configuration' tab. Below it, a section titled 'SMS Alert' is expanded. Under this section, there is a 'WAN IP Change Alert' heading. Below the heading is a label 'Recipient's Number' followed by an empty text input field. At the bottom of this section is an 'Apply' button.

**Recipient's Number (WAN IP Change Alert):** Enter the Recipient's number that will receive the alert message once a WAN IP change has been detected.

## Configure Log

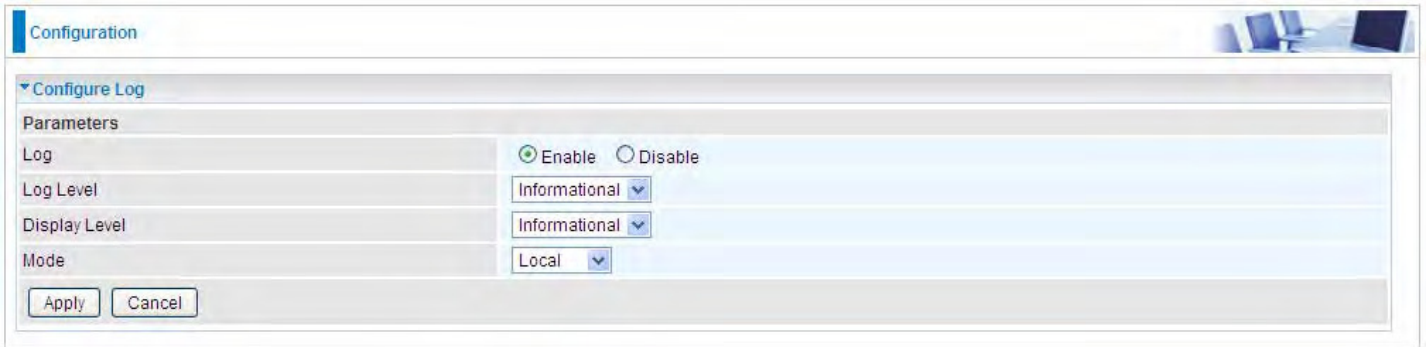

Configuration

▼ Configure Log

Parameters

Log  Enable  Disable

Log Level Informational ▼

Display Level Informational ▼

Mode Local ▼

Apply Cancel

**Log:** Enable or disable this function.

**Log level:** Select your log level. The log level allows you to configure which types of events are logged. There are eight log levels from high to low are displayed below:

- ① **Emergency** = system is unusable
- ① **Alert** = action must be taken immediately
- ① **Critical** = critical conditions
- ① **Error** = error conditions
- ① **Warning** = warning conditions
- ① **Notice** = normal but significant conditions
- ① **Informational** = information events
- ① **Debugging** = debug-level messages

The gateway records all log events at the chosen level and above. For instance, if you set the log level to Critical, all critical, alert, and emergency events are logged, but none of the others are recorded

**Display Level:** Display the log according to the level you set when you view system log. Once you set the display level, the logs of the same or higher priority will be displayed.

**Mode:** Select the mode the system log adopted. Three modes: local, Remote and Both.

- ① **Local:** Select this mode to store the logs in the router's local memory.
- ① **Remote:** Select this mode to send the log information to a remote log server. Then you must assign the remote log server and port, 514 is often used.
- ① **Both:** Logs stored adopting above two ways.

Click **Apply** to save your settings.