



motorola



---

# USER'S GUIDE

## Wi-Fi® Home Video Camera

Models: FOCUS68P, FOCUS68P-2, FOCUS68P-3, FOCUS68P-4  
FOCUS68P-W, FOCUS68P-W2, FOCUS68P-W3, FOCUS68P-W4

*The features described in this user's guide are subject to modifications without prior notice.*

# Welcome...

## *to your new Motorola Wi-Fi<sup>®</sup> Home Video Camera!*

Thank you for purchasing your new Motorola Wi-Fi<sup>®</sup> Home Video Camera. If you have always wondered what happens when you are away, wonder no more. Now you can monitor your children, pets or property with this easy to use system. You can install the Camera only from your iPhone<sup>®</sup>/iPad<sup>®</sup> or Android<sup>™</sup> devices and view the Camera video from your PC or Notebook, as well as from your iPhone<sup>®</sup>/iPad<sup>®</sup> or Android<sup>™</sup> devices.

Please keep your original dated sales receipt for your records. For warranty service of your Motorola product, you will need to provide a copy of your dated sales receipt to confirm warranty status. Registration is not required for warranty coverage.

For product related questions, please call:

**US and Canada 1-888-331-3383**  
**Email: [support@motorolastore.com](mailto:support@motorolastore.com)**

---

This User's Guide has all the information you need to make the most out of your product.

Please read the Safety Instructions on pages 5 - 6 before you install the unit.

### **Inside the Box**

- 1 x Wi-Fi<sup>®</sup> Camera Unit
- 1 x Power Adapter
- 1 x Quick Start Guide

In multi-camera packs, you will find one or more additional Camera Units with power adapter units.

## Overview of your Camera

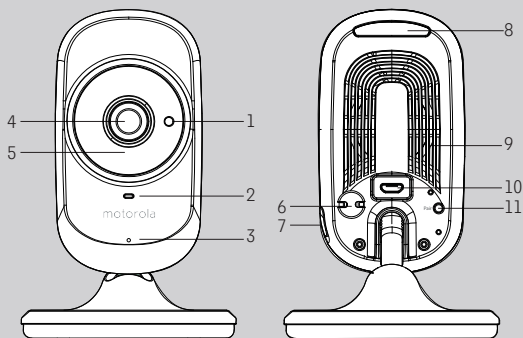

1. Light Sensor (for night mode detection)
2. Power / Status indicator
3. Microphone
4. Camera Lens
5. Infrared LEDs (for night vision)
6. Temperature Sensor
7. ON/OFF Switch
8. Night Light
9. Speaker
10. Micro USB socket
11. PAIR Button

### Important guidelines for installing your Wi-Fi<sup>®</sup> Camera Unit

- Use of other 2.4 GHz products, such as other wireless networks, Bluetooth<sup>™</sup> systems or microwave ovens may cause interference with this product. Keep the Wi-Fi<sup>®</sup> Camera Unit away from these types of products, or turn them off if they appear to be causing interference.
- Always ensure that you have a good Wi-Fi<sup>®</sup> connection available.

---

## Table of contents

---

<b>1. Safety Instructions</b> .....	<b>5</b>
<b>2. System Requirements</b> .....	<b>7</b>
<b>3. Getting started - Connecting Devices</b> .....	<b>8</b>
3.1 Setup .....	8
3.2 User Account and Camera Setup on Android™ Devices .....	9
3.2.1 Power ON and Connect the Camera .....	9
3.2.2 Download Hubble for Motorola Monitors App .....	9
3.2.3 Run Hubble for Motorola Monitors App on Android™ device .....	9
3.2.4 Add the Camera to your account .....	10
3.3 User Account and Camera Setup on iPhone®/iPad® .....	14
3.3.1 Power ON and Connect the Camera .....	14
3.3.2 Download Hubble for Motorola Monitors App .....	14
3.3.3 Run Hubble for Motorola Monitors App on iPhone®/iPad® .....	14
3.3.4 Add the Camera to your account .....	15
<b>4. Camera Functions</b> .....	<b>19</b>
4.1 Connecting the Camera Unit to power .....	19
4.2 Overview of the Features on Hubble App.....	19
<b>5. Working with PC/Notebook</b> .....	<b>21</b>
<b>6. Procedure for Resetting the Camera</b> .....	<b>22</b>
<b>7. Help</b> .....	<b>23</b>
<b>8. General Information</b> .....	<b>29</b>
<b>9. Technical Specifications</b> .....	<b>35</b>

# 1. Safety Instructions



## WARNING:

**STRANGULATION HAZARD** - In case this unit is being used to monitor infants or children, keep the unit and adapter cord more than 1 metre away from the cot and out of their reach. Never place the Camera or cords within a cot or near a bed. Secure the cord away from children's reach. Never use extension cords with AC Adapters. Only use the AC Adapters provided.

As with any electrical device, supervision of your pet's usage should be exercised until your pet is acclimated to the product. If your pet is prone to chewing, we strongly recommend you keep this and all other electrical devices out of its reach.

---

## Wi-Fi® CAMERA UNIT SET UP & USE :

---

- Place the Wi-Fi® Camera Unit on a flat surface, such as a chest of drawers, desk, shelf or wall-mount it using the keyhole slot in the Camera base.
- NEVER place the Wi-Fi® Camera Unit or cords within the cot.



**WARNING**

*This Wi-Fi<sup>®</sup> Camera Unit is compliant with all relevant electromagnetic field standards and is, when handled as described in the User's Guide, safe to use. Therefore, always read the instructions in this User's Guide carefully before using the device.*

- Adult assembly is required due to small parts. Keep all small parts away from children.
- This product is not a toy. Do not allow children to play with it.
- This Wi-Fi<sup>®</sup> Camera Unit is not a substitute for responsible adult supervision.
- Keep this User's Guide for future reference.
- Do not place the Wi-Fi<sup>®</sup> Camera Unit or cords in the cot or within reach of the baby (the unit should be at least 1 metre away).
- Keep the cords out of reach of children.
- Do not cover the Wi-Fi<sup>®</sup> Camera Unit with a towel or blanket.
- Test the Wi-Fi<sup>®</sup> Camera Unit and all its functions so that you are familiar with it prior to use.
- Do not use the Wi-Fi<sup>®</sup> Camera Unit near water.
- Do not install the Wi-Fi<sup>®</sup> Camera Unit near a heat source.
- Only use the Power Adapter provided. Do not use other power adapters as this may damage the device.
- Never use extension cords with Power Adapters.
- Do not touch the plug contacts with sharp or metal objects.

## 2. System Requirements

### Web Portal

- Windows<sup>®</sup> 7
- Mac OS<sup>®</sup> 10.7
- Chrome<sup>™</sup> 24
- Internet Explorer<sup>®</sup> 9
- Safari<sup>®</sup> 6
- Java<sup>™</sup> 7
- Firefox<sup>®</sup> 18.0
- Adobe<sup>®</sup> Flash<sup>®</sup> Player 15.0

### Android<sup>™</sup> System

- Version 4.2 or above

### iPhone<sup>®</sup> / iPad<sup>®</sup> iOS

- Version 7.0 or above

### High Speed (Wi-Fi<sup>®</sup>) Internet

- At least 0.6 Mbps upload bandwidth per camera (you can test your internet speed on this site: <http://www.speedtest.net>)

## 3. Getting started - Connecting Devices

How does it work?

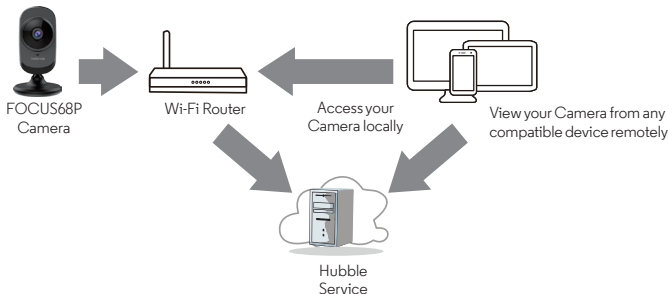

When a user tries to access the Camera, our Hubble server authenticates the user's identity and permits access to the Camera.

### 3.1 Setup

Connect the Camera to the Power Adapter, then plug into an electrical outlet and make sure the ON/OFF Switch is in the ON position. The Camera must be within range of the Wi-Fi<sup>®</sup> router with which you want to connect. Make sure the password of the router is available for entering during the in-app setup process.

#### Status of LED Indication:

- Pair / Setup state: LED is red and blue and slowly flashing
- Unconnected state: LED is red and slowly flashing
- Connected state: LED is blue and always on
- Ready for connection state: LED is blue and slowly flashing

Note: You can only setup via a compatible smartphone or tablet and not via a PC.





## 3.2 User Account and Camera Setup on Android™ Devices

### What you need

- Wi-Fi® Camera Unit
- Power adapter for the Camera
- Device with Android™ system version 4.2 and above

#### 3.2.1 Power ON and Connect the Camera

- Connect the power adapter to an electrical outlet and insert the plug into the micro USB socket on the back of the Camera Unit.
- Make sure that the ON/OFF switch is in the ON position.
- The Camera's Red LED flashes after the Camera has finished booting. When you hear one beep, this means that the Camera is ready for setup.

#### 3.2.2 Download Hubble for Motorola Monitors App

- Go to Google Play™ Store to search for "Hubble for Motorola Monitors".
- Download "Hubble for Motorola Monitors" App from Google Play™ Store and install it on your Android™ device

#### 3.2.3 Run Hubble for Motorola Monitors App on Android™ device

- Ensure that your Android™ device is connected to your Wi-Fi® router.
- Run "Hubble for Motorola Monitors" App, enter your account information, read through the Terms of Service, then select "I agree to the Terms of Use" before you tap Create. (Picture A1)

### Note

*If you already have a Hubble App account, please select Already have an Account? to go to the next step.*

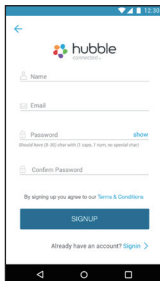

A1

### 3.2.4 Add the Camera to your account

- Tap  on the **lower** right corner of the screen to add camera. (Picture A2)

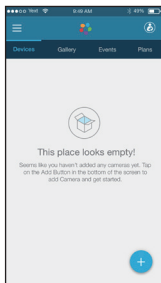

A2

- The following setup instructions will appear on the screen. (Pictures A3, A3a)



A3

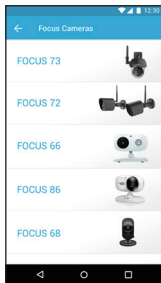

A3a

- Plug in and switch on the camera, and wait for a couple of minutes for it to warm up.
- Tap **Continue** when the Camera LED starts to blink.

- The following setup instructions will appear on the screen. (Picture A4)

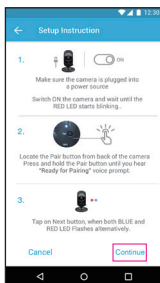

A4

- Press and hold the **PAIR** button on the bottom left edge of the Camera Unit for 3 seconds. You will then hear a beep tone, followed by a voice prompt indicating that the Camera is ready for pairing.
- Tap **Continue**.
- The App will automatically search for and connect to your Camera as shown in the pictures below. (Pictures A5, A6)
- The blue/red colour LED on the Camera Unit will flash.

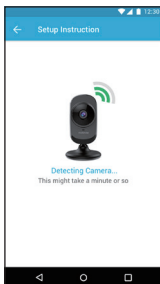

A5

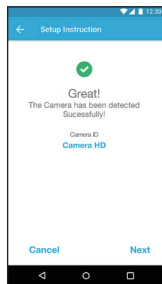

A6

- Select your Wi-Fi<sup>®</sup> Network, enter your password and then tap Connect. (Pictures A7, A8)

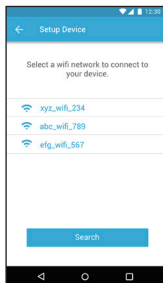

A7

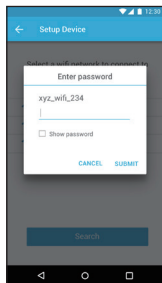

A8

- It will take a few minutes for the Camera to connect to the Wi-Fi<sup>®</sup> network before showing the connection status. (Pictures A9, A10)
- If connection fails, please tap Retry and repeat the steps starting from 3.2.4.

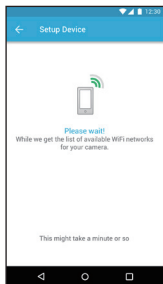

A9



A10

- Tap View Camera to view the video captured by the Camera Unit. The LED indicator on the Camera Unit will light up in blue.

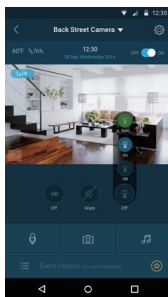

All

- Night Light:  
Tap Night Light Icon to select the control modes  
Off – Turn off Light  
On – Turn on Light  
Auto – Turn on when environment light is low

### 3.3 User Account and Camera Setup on iPhone®/iPad®

#### What you need

- Wi-Fi® Camera Unit
- Power adapter for the Camera
- iPhone® / iPad® with iOS version 7.0 and above

#### 3.3.1 Power ON and Connect the Camera

- Connect the power adapter to an electrical outlet and insert the plug into the micro USB socket at the back of the Camera.
- Make sure that the ON/OFF switch is in the ON position.
- The Camera's red LED flashes after the Camera has finished booting. When you hear one beep, this means that the Camera is ready for setup.

#### 3.3.2 Download Hubble for Motorola Monitors App

- Go to App Store to search for "Hubble for Motorola Monitors".
- Download "Hubble for Motorola Monitors" App and install it on your iPhone®/iPad®.

#### 3.3.3 Run Hubble for Motorola Monitors App on iPhone®/iPad®

- Ensure that your iPhone®/iPad® is connected to your Wi-Fi® Router.
- Run the "Hubble for Motorola Monitors" App, enter your account information, read through the Terms of Service, and then select "I agree to the Terms of Service" before you tap Create. (Picture i1)

**Note:** If you already have a Hubble App account, please select Already have an Account? to go to the next step (Picture i1).

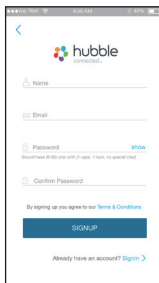

i1

### 3.3.4 Add the Camera to your account

- Tap  on the lower right corner of the screen to add camera.

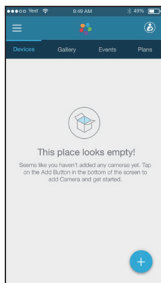

i2

- The following setup instructions will appear on the screen. (Pictures i3, i4)

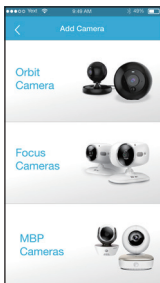

i3



i4

- Plug in and switch on the camera, and wait for a couple of minutes for it to warm up.
- Tap Continue when the camera LED starts to blink.

- The following setup instructions will appear on the screen. (Picture i5)



i5

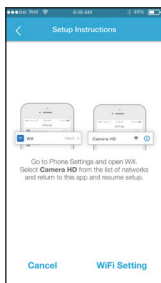

i6

- Press and hold the PAIR button on the bottom left edge of the Camera for 3 seconds.
- Go to Settings → Wi-Fi menu on your iPhone®/iPad®. (Picture i6)
- Select your Camera from the list of networks. (Picture i7)
- Return to the Hubble app to resume setup. (Picture i8)

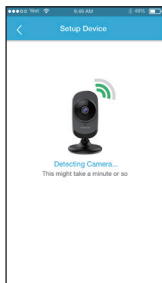

i7

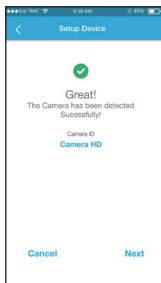

i8



- Tap Continue. (Picture i9)



i9

- Select your Wi-Fi<sup>®</sup> network and tap Continue. (Picture i10)
- Enter your Wi-Fi<sup>®</sup> password and tap Next. (Picture i11)

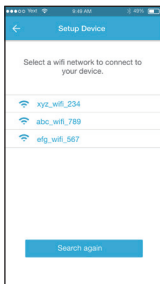

i10

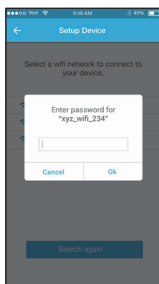

i11

- It will take a few minutes for the Camera Unit to connect to the Wi-Fi® network before showing the connection status. (Picture i12)



i12









- Tap **View Live Camera** to view the video captured by the Camera. The LED indicator on the Camera Unit will light up in blue.









## 4. Camera Functions

### 4.1 Connecting the Camera Unit to power

- Connect the power adapter to an electrical outlet and insert the plug into the micro USB socket on the back of the Camera Unit.
- Slide the ON/OFF switch to the ON position. The power indicator LED will light up in blue if the camera is already connected, or will flash red if it needs to be paired. (Note: To switch off the device, slide the ON/OFF switch to OFF.)
- Run the Hubble App on your smart device.

### 4.2 Overview of the Features on Hubble App

	<b>Event History</b>	<ul style="list-style-type: none"> <li>• Tap <b>Event History</b>  to access the video record list that is triggered by Motion or Sound detection.</li> <li>• <b>Delete Events</b>  Tap to delete selected event(s).</li> </ul>
	<b>Photo/Video</b>	<ul style="list-style-type: none"> <li>• Take a photo or record a video from your Camera.</li> <li>• Tap the Video icon  to activate Video function. Tap and hold the red button  to start recording and release to stop.</li> <li>• Tap the Camera icon  to switch to Camera mode. You can capture photos from Camera view.</li> </ul> <p><b>Note:</b>  <i>Photos and videos will be stored in the internal flash memory of your smart device, and can be accessed via the Gallery  or Media Player (Android Device). To play videos, please use the Hubble App.</i></p>

	<b>Lullabies</b>	Tap to access the Melody menu and select one of the 5 pre-set melodies you wish to play on your Camera Unit.
	<b>Temperature Measure</b>	The temperature reading from the temperature sensor at the back of the Camera Unit will display on the screen of your device. The readings will turn RED if the temperature goes beyond the High/ Low temperature that was set in your Account.
	<b>Two-way communication</b>	Tap to activate the function. Press the round button  once to speak through the Camera Unit. Toggle the button again to listen to the audio feedback from the Camera Unit.
	<b>Speaker</b>	Tap to toggle speaker on or off.
	<b>Setting</b>	You can change the Camera settings by tapping  on the <b>Settings</b> icon.
	<b>Add Camera</b>	Enter Add Camera procedures.
	<b>Night Light</b>	Tap to goggle night light mode.

## 5. Working with PC/Notebook

- Go to <http://www.hubbleconnected.com/motorola/login/>
- Enter your **User Name** and **Password** and then click Login if you have already created an account.
- Click on the Camera list paired in your account via Android™ device or iPhone®/iPad® and the Camera view will appear on screen. You can easily stay connected with your favorite people, places and pets with live video streaming.
- On the website, you can change the **Settings** by following the Menu instructions.

## 6. Procedure for Resetting the Camera

**Note:** If your Camera is moved from one router (e.g. home) to another (e.g. office) or you have Camera setup issues, then the Camera must be reset.

Please reset the Camera with the following procedures:

1. Slide the ON/OFF switch to OFF.
2. Press and hold the PAIR button, then slide the ON/OFF switch to ON.
3. Release the PAIR button when you hear a confirmation beep and wait for the Camera Unit to complete an internal reset procedure. The LED indicator will turn red and flash slowly when the Camera Unit is reset successfully.
4. You can add your Camera again by following the steps in section 3.2.4 for Android devices or in section 3.3.4 for iOS devices.

## 7. Help

### Noise interference

To avoid background noise or echoes, ensure that there is enough distance between your device and the Wi-Fi® Camera Unit.

Use of other 2.4 GHz products, such as Bluetooth™ systems or microwave ovens, may cause interference with this product. Keep the Wi-Fi® Camera Unit at least 1.5m away from these types of products, or turn them off if they appear to be causing interference.

### Lost connection

Check your Wi-Fi® settings. If necessary reconnect your Wi-Fi®. Ensure the Wi-Fi® Camera Unit is switched ON. Wait a few minutes to connect to the Wi-Fi® system.

### If you forget your password

If you do not remember your password, tap **Forgot password** and submit your e-mail address. A new password will be sent to your e-mail address immediately.

### Troubleshooting for Wi-Fi® Internet Viewing

Category	Problem Description / Error	Solution
Account	I am unable to login even after registration.	Please check your user name and password.
Account	I receive an error message saying: "Email ID is not registered".	Please ensure that you have registered with us. Tap <b>Create Account</b> to create an account.
Account	What do I do if I forgot my password?	Click on the "Forgot Password" link on <a href="https://app.hubbleconnected.com/#lostpassword">https://app.hubbleconnected.com/#lostpassword</a> OR on your Android™ or iOS application. An email will be sent to your registered email address.



Account	I am unable to receive a new password although I have used the "Forgot password" option.	<ol style="list-style-type: none"><li>1. The e-mail might have been sent to your Junk Mail Folder. Please check your Junk Mail Folder.</li><li>2. There might be a delay in getting your e-mail. Please wait a few minutes and refresh your email account.</li></ol>
Connectivity Issues	I get a message: We are having problems accessing your camera. This could be due to lack of internet connection. Please wait and try again later.	<ol style="list-style-type: none"><li>1. Please try again in a few minutes. This could be because of any issue with your internet connection.</li><li>2. If the problem remains, please restart your Camera to check if this fixes the problem.</li><li>3. Please restart your Wireless Router.</li></ol>
Viewing Camera	When I am in "remote mode", the video stops after 5 minutes. How do I view for longer?	<p>When you are accessing your Camera via a network different from your home network (over the internet) your video times out after 5 minutes.</p> <p>You can click on the Camera again from the Android™/iOS application to start streaming again.</p> <p>If you are accessing from your webbrowser, then you can press on the <b>Reload</b> button to start viewing your Camera video stream again.</p>
Features	The sound alert setting threshold is not right.	You can Adjust Sound Sensitivity to trigger notifications under Camera Setting menu.





Setting Up	While I am adding a new Camera to my account, I am not able to find any Cameras to add.	If you are trying to add a Camera which has previously been added into your account or another account, you will first have to reset the Camera. This can be done by pressing and holding the PAIR button at the bottom of the Camera for 5 seconds.
General	What are the supported browsers for accessing from my PC/ Mac?	We recommend using Google Chrome 24 or above. However the following browsers are also supported: Internet Explorer 9.0 or above (for PC), Safari 6.0 or above (for Mac) or Firefox 18.0 or above (both PC or Mac).
General	What is the significance of LED flashing?	<p>A flashing LED indicates the following status:</p> <p>Slow flashing: 1. Your Camera is in setup mode. You can add the Camera to your account in this mode. Out of the box, the Camera is in Setup mode. To reset to Setup mode, press and hold the PAIR button on the bottom of the Camera until you hear a beep.</p> <p>Slow flashing: 2. The Camera is either connecting to the router or has lost the link to the router. Please ensure that the Camera is in the Wi-Fi® signal range.</p> <p>LED is stable: The Camera is connected to the Wi-Fi® network.</p>
Connectivity issues	I am not able to access my Camera.	Please check if the Camera is within Wi-Fi® range. If the LED on your Camera is flashing slowly, please try to move the Camera closer to the router for better Wi-Fi® connectivity and try again.



Setting Up	During setup on devices for Android™ and iOS, I am not able to find my Camera during the last step and the setup fails.	Please reset the Camera to setup mode and try again. Press and hold the PAIR button on the bottom of the Camera until you hear a beep. Wait for a minute for the Camera to restart. When the Camera LED is flashing, this indicates that it is in setup mode. Now restart the setup from your smartphone again.
Connectivity Issues	Even though I am accessing my Camera from the same Wi-Fi® network, I still find my Camera is shown as remote. I can only access it for 5 minutes at a time.	Please check your wireless router settings. For example, for Buffalo brand routers there is an option called Wireless Isolation. Please disable this option.
Camera	When I try to view the Camera, I get a prompt for Camera firmware upgrade. What should I do?	Please upgrade your firmware. This takes around 5 minutes. We push upgrades from time to time to improve the Camera features.
General	Which platforms are supported for accessing my Camera?	Minimum requirement: Windows® 7* *Java browser plug-in needed Mac OS® version 10.7 Chrome™ version 24 Internet Explorer® version 9 Safari® version 6 Java™ version 7 Firefox® version 18.0 Adobe® Flash® Player 15.0 Android™ 4.2 iPhone® /iPad® iOS version 7.0



General	I do not hear any sound when I am accessing a remote Camera.	You can tap on the speaker icon in the video stream screen to hear audio. By default the audio is not ON when you are accessing a remote Camera.
General	What is the meaning of "Local Camera" and "Remote Camera"?	<ul style="list-style-type: none"><li>- When you are accessing your Camera from the same wireless network (Home) in which it is configured, it is a Local Camera. When you are accessing your Camera away from your home it is a Remote Camera. You may be using 3G, 4G or 4G LTE or a Wi-Fi® connection outside of your home.</li></ul>
General	How do I download the App for Android™ and iOS devices?	<p><b>Android™:</b></p> <ul style="list-style-type: none"><li>- Open the Google Play Store on your Android™ device.</li><li>- Select Search</li><li>- Type in "Hubble for Motorola Monitors"</li><li>- The results will show the Hubble App</li><li>- Select to install it</li></ul> <p><b>iOS Device:</b></p> <ul style="list-style-type: none"><li>- Open the App Store<sup>SM</sup></li><li>- Select Search</li><li>- Type in "Hubble for Motorola Monitors"</li><li>- The results will show the Hubble App</li><li>- Select to install it</li></ul>



Setting up	When the video is cut off, the application attempts to reconnect and this results in lost sound and choppy video.	You will need to turn off the Auto Lock function of your device to ensure continuous video/audio streaming.
Features	How many users can access the Camera at one time?	If you are accessing in Local Mode, two users are supported, after two users all streaming will go through the remote server. This allows for unlimited user access to a single Camera at one time.
Connectivity issues	I found interference caused by my other webcam devices.	Video streaming performance is related to internet bandwidth, especially if you have 2 or more video streaming devices that are working through the same router.

## 8. General Information

If your product is not working properly....

1. Read this User's Guide.
2. Contact Customer Service at:  
US and Canada 1-888-331-3383  
Email: support@motorolastore.com

### Consumer Products and Accessories Limited Warranty ("Warranty")

Thank you for purchasing this Motorola branded product manufactured under license by Binatone Electronics International LTD ("BINATONE").

#### ***What Does this Warranty Cover?***

Subject to the exclusions contained below, BINATONE warrants that this Motorola branded product ("Product") or certified accessory ("Accessory") sold for use with this product that it manufactured to be free from defects in materials and workmanship under normal consumer usage for the period outlined below. This Warranty is your exclusive warranty and is not transferable.

#### ***Who is covered?***

This Warranty extends only to the first consumer purchaser, and is not transferable.

#### ***What will BINATONE do?***

BINATONE or its authorized distributor at its option and within a commercially reasonable time, will at no charge repair or replace any Products or Accessories that does not conform to this Warranty. We may use functionally equivalent reconditioned/ refurbished/ pre-owned or new Products, Accessories or parts.

### ***What Other Limitations Are There?***

ANY IMPLIED WARRANTIES, INCLUDING WITHOUT LIMITATION THE IMPLIED WARRANTIES OF MERCHANTABILITY AND FITNESS FOR A PARTICULAR PURPOSE, SHALL BE LIMITED TO THE DURATION OF THIS LIMITED WARRANTY, OTHERWISE THE REPAIR OR REPLACEMENT PROVIDED UNDER THIS EXPRESS LIMITED WARRANTY IS THE EXCLUSIVE REMEDY OF THE CONSUMER, AND IS PROVIDED IN LIEU OF ALL OTHER WARRANTIES, EXPRESS OR IMPLIED. IN NO EVENT SHALL MOTOROLA OR BINATONE BE LIABLE, WHETHER IN CONTRACT OR TORT (INCLUDING NEGLIGENCE) FOR DAMAGES IN EXCESS OF THE PURCHASE PRICE OF THE PRODUCT OR ACCESSORY, OR FOR ANY INDIRECT, INCIDENTAL, SPECIAL OR CONSEQUENTIAL DAMAGES OF ANY KIND, OR LOSS OF REVENUE OR PROFITS, LOSS OF BUSINESS, LOSS OF INFORMATION OR OTHER FINANCIAL LOSS ARISING OUT OF OR IN CONNECTION WITH THE ABILITY OR INABILITY TO USE THE PRODUCTS OR ACCESSORIES TO THE FULL EXTENT THESE DAMAGES MAY BE DISCLAIMED BY LAW.

Some jurisdictions do not allow the limitation or exclusion of incidental or consequential damages, or limitation on the length of an implied warranty, so the above limitations or exclusions may not apply to you. This Warranty gives you specific legal rights, and you may also have other rights that vary from one jurisdiction to another.

Products Covered	Length of Coverage
Consumer Products	<b>One (1) year</b> from the date of the products original purchase by the first consumer purchaser of the product.
Consumer Accessories	<b>Ninety (90) days</b> from the date of the accessories original purchase by the first consumer purchaser of the product.
Consumer Products and Accessories that are Repaired or Replaced	<b>The balance of the original warranty or for Ninety (90) days</b> from the date returned to the consumer, whichever is longer.

### Exclusions

**Normal Wear and Tear.** Periodic maintenance, repair and replacement of parts due to normal wear and tear are excluded from coverage.

**Batteries.** Only batteries whose fully charged capacity falls below 80% of their rated capacity and batteries that leak are covered by this Warranty.

**Abuse & Misuse.** Defects or damage that result from: (a) improper operation, storage, misuse or abuse, accident or neglect, such as physical damage (cracks, scratches, etc.) to the surface of the product resulting from misuse; (b) contact with liquid, water, rain, extreme humidity or heavy perspiration, sand, dirt or the like, extreme heat, or food; (c) use of the Products or Accessories for commercial purposes or subjecting the Product or Accessory to abnormal usage or conditions; or (d) other acts which are not the fault of MOTOROLA or BINATONE, are excluded from coverage.

**Use of Non-Motorola branded Products and Accessories.** Defects or damage that result from the use of Non-Motorola branded or certified Products or Accessories or other peripheral equipment are excluded from coverage.

**Unauthorized Service or Modification.** Defects or damages resulting from service, testing, adjustment, installation, maintenance, alteration, or modification in any way by someone other than MOTOROLA, BINATONE or its authorized service centres, are excluded from coverage.

**Altered Products.** Products or Accessories with (a) serial numbers or date tags that have been removed, altered or obliterated; (b) broken seals or that show evidence of tampering; (c) mismatched board serial numbers; or (d) nonconforming or non-Motorola branded housings, or parts, are excluded from coverage.

**Communication Services.** Defects, damages, or the failure of Products or Accessories due to any communication service or signal you may subscribe to or use with the Products or Accessories is excluded from coverage.

### ***How to Obtain Warranty Service or Other Information?***

To obtain service or information, please call:

US and Canada 1-888-331-3383

Email: [support@motorolastore.com](mailto:support@motorolastore.com)

You will receive instructions on how to ship the Products or Accessories at your expense and risk, to a BINATONE Authorized Repair Centre.

To obtain service, you must include: (a) the Product or Accessory; (b) the original proof of purchase (receipt) which includes the date, place and seller of the Product; (c) if a warranty card was included in your box, a completed warranty card showing the serial number of the Product; (d) a written description of the problem; and, most importantly; (e) your address and telephone number.

These terms and conditions constitute the complete warranty agreement between you and BINATONE regarding the Products or Accessories purchased by you, and supersede any prior agreement or representations, including representations made in any literature publications or promotional materials issued by BINATONE or representations made by any agent employee or staff of BINATONE, that may have been made in connection with the said purchase.



## FCC and IC regulations

### FCC Part 15

**NOTE:** This equipment has been tested and found to comply with the limits for a Class B digital device, pursuant to Part 15 of the Federal Communications Commission (FCC) rules. These limits are designed to provide reasonable protection against harmful interference in a residential installation. This equipment generates, uses and can radiate radio frequency energy and, if not installed and used in accordance with the instructions, may cause harmful interference to radio communications. However, there is no guarantee that interference will not occur in a particular installation. If this equipment does cause harmful interference to radio or television reception, which can be determined by turning the equipment off and on, the user is encouraged to try to correct the interference by one or more of the following measures:

- Reorient or relocate the receiving antenna.
- Increase the separation between the equipment and receiver.
- Connect the equipment into an outlet on a circuit different from that to which the receiver is connected.
- Consult the dealer or an experienced radio/TV technician for help. Changes or modifications to this equipment not expressly approved by the party responsible for compliance could void the user's authority to operate the equipment.

This device complies with Part 15 of the FCC rules. Operation is subject to the following two conditions: (1) this device may not cause harmful interference, and (2) this device must accept any interference received, including interference that may cause undesired operation. Privacy of communications may not be ensured when using this device.

To ensure safety of users, the FCC has established criteria for the amount of radio frequency energy that can be safely absorbed by a user or bystander according to the intended usage of the product. This product has been tested and found to comply with the FCC criteria.

This Class B digital apparatus complies with Canadian ICES-003. CANICES-3(B)/NMB-3(B)

## **WARNING**

Changes or modifications, to this equipment not expressly approved by the party responsible for compliance could void the user's authority to operate the equipment.

The socket-outlet shall be installed near the equipment and shall be easily accessible.

### **Industry Canada**

This device complies with Industry Canada licence-exempt RSS standard(s):

Operation is subject to the following Two conditions:(1) this device may not cause interference, and (2) this device must accept any interference, including interference that may cause undesired operation of the device.

The term "IC: " before the certification/registration number only signifies that the Industry Canada technical specifications were met. This product meets the applicable Industry Canada technical specifications.

Le présent appareil est conforme aux CNR d'Industrie Canada applicables aux appareils radio exempts de licence. L'exploitation est autorisée aux deux conditions suivantes : (1) l'appareil ne doit pas produire de brouillage, et (2) l'utilisateur de l'appareil doit accepter tout brouillage radioélectrique subi, même si le brouillage est susceptible d'en compromettre le fonctionnement.

FCC RF Radiation Exposure Statement Caution: This Transmitter must be installed to provide a separation distance of at least 20 cm from all persons.

IC Radiation Déclaration d'exposition Attention: Cet émetteur doit être installé pour fournir une distance de séparation d'au moins 20 cm de toute personne.

## 9. Technical Specifications

### Camera Unit

Wi-Fi®	2400 -2483.5 MHz(802.11 b/g/n)
Image sensor	Colour CMOS 1M Pixels
Lens	f=2.80 mm, F=2.5
IR LED	8 pcs
Power Adapter	Zhongshan Baolijin Electronic Co.,Ltd. BLJ06W050100P1-U, Input: 100-240V 50/60HZ 0.2A; Output: 5V 1000mA. OR TenPao International Ltd. S006AKU0500100, Input: 100-240V 50/60HZ 0.2A; Output: 5V 1000mA.



motorola

Manufactured, distributed or sold by Binatone Electronics International LTD., official licensee for this product. MOTOROLA and the Stylised M logo are trademarks or registered trademarks of Motorola Trademark Holdings, LLC. and are used under license. Apple logo and Safari are trademarks of Apple Inc., registered in the U.S. and other countries. App Store is a service mark of Apple Inc. Google Play, Android, and Chrome are trademarks of Google Inc. Wi-Fi is a trademark of the Wi-Fi Alliance. Internet Explorer and Windows are trademarks of the Microsoft group of companies. Firefox is a registered trademark of the Mozilla Foundation. Adobe and Flash are either registered trademarks or trademarks of Adobe Systems Incorporated. Java is a registered trademark of Oracle and/or its affiliates. All other trademarks are the property of their respective owners.

© 2017 Motorola Mobility LLC. All rights reserved.



US\_EN Version 1.0

Printed in China