



MOTOROLA

**USER'S GUIDE
MBP15**

DIGITAL BABY MONITOR

USER'S GUIDE

The features described in this user's guide are subject to modifications without prior notice.

V 0.1



Welcome...

to your new Motorola Digital Baby Monitor!

Thank you for purchasing the MBP15. This baby monitor uses digital communication which ensures that you can hear your baby clearly without any distracting noise or interference.

Please retain your original dated sales receipt for your records. For warranty service of your Motorola product, you will need to provide a copy of your dated sales receipt to confirm warranty status. Registration is not required for warranty coverage.

For product related questions, please call:

US 1-888-331-3383 or Canada 905-831-6555

On the Web: www.motorola.com

This User's Guide provides you with all the information you need to get the most from your product.

Before you can use the baby monitor, you'll need to insert and fully charge the battery on the Parent unit. Please read the Safety Instructions on page 6 before you install the units.

Got everything?

- 1 x Parent unit
- 1 x Baby unit
- 1 x Rechargeable battery pack for the Parent unit
- 1 x Desktop charger with power adaptor for the Parent unit
- 1 x Power adaptor for the Baby unit





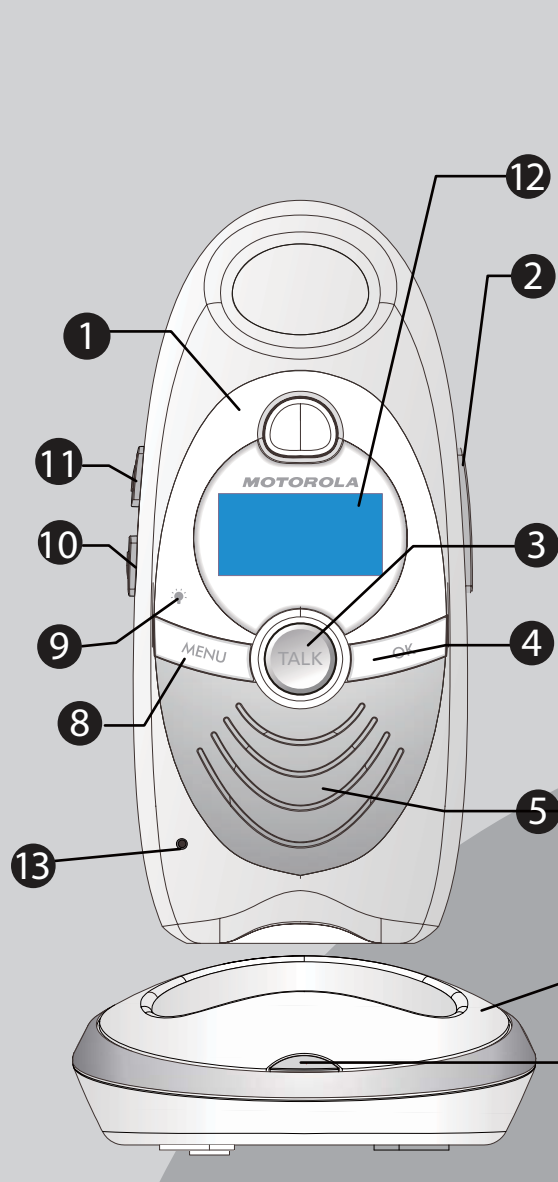

IMPORTANT

The non-rechargeable batteries for the Baby unit are not supplied with your product. We recommend the batteries to be installed before use, so that the unit continues to work in the event of a mains power failure.

Overview of your Parent unit



A

1. Volume indicator LEDs
2. Power On/Off button 
3. Push to talk button 
(Talk to baby)
4. Confirm button 
5. Speaker
6. Desktop charger
7. Charging LED
8. Menu button 
9. Link indicator LED 
10. Volume down button 
11. Volume up button 
12. Display (see next page)
13. Microphone

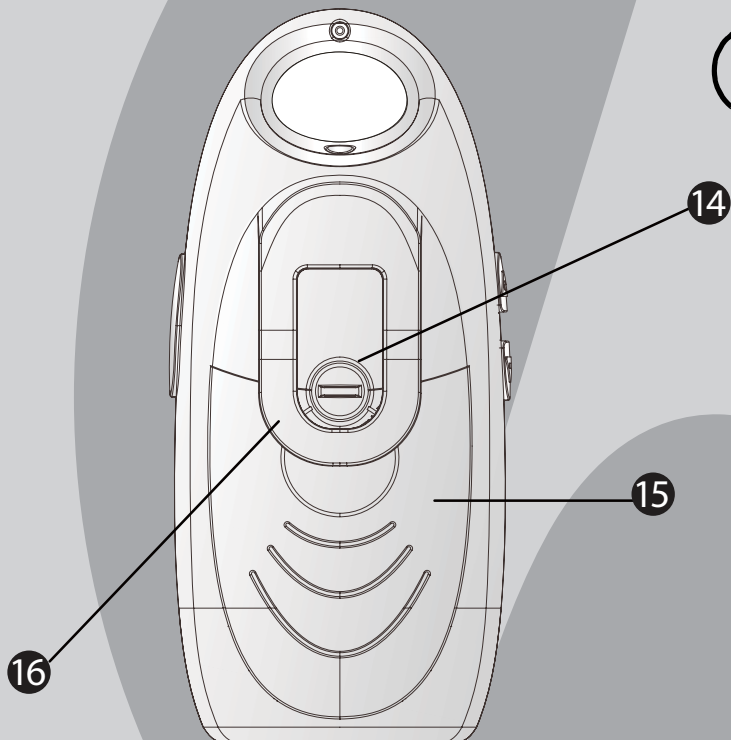



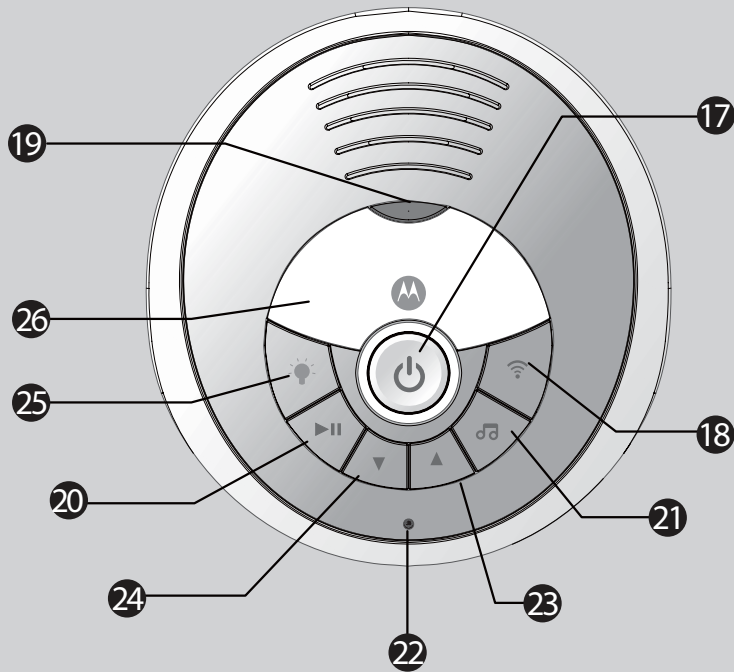

B

14. Battery cover screw
15. Battery cover
16. Belt Clip

Overview of your Baby unit



(C)

- 17. On/Off button 
- 18. Paging button 
- 19. Power LED
- 20. Play/Pause button 
- 21. Lullaby button 
- 22. Microphone
- 23. Volume up button 
- 24. Volume down button 
- 25. Night Light button 
- 26. Night Light

(D)

- 27. Thermo sensor
- 28. Battery cover screw
- 29. Battery cover
- 30. Power adaptor connector

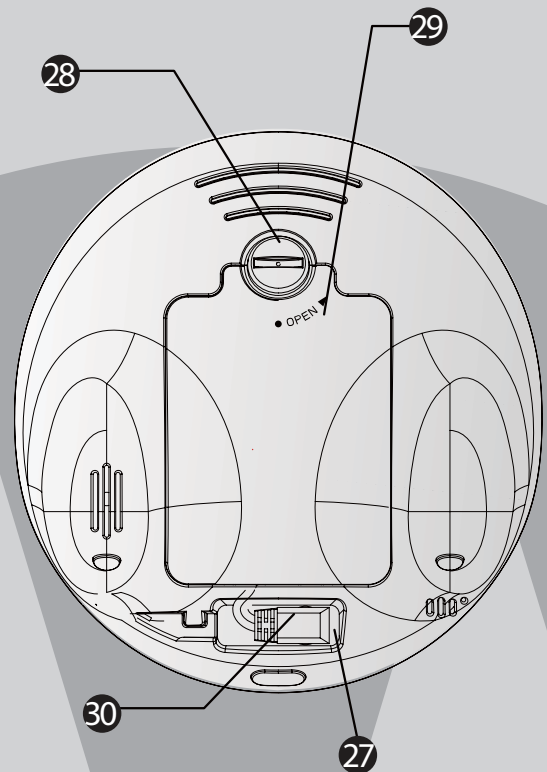

LCD Display

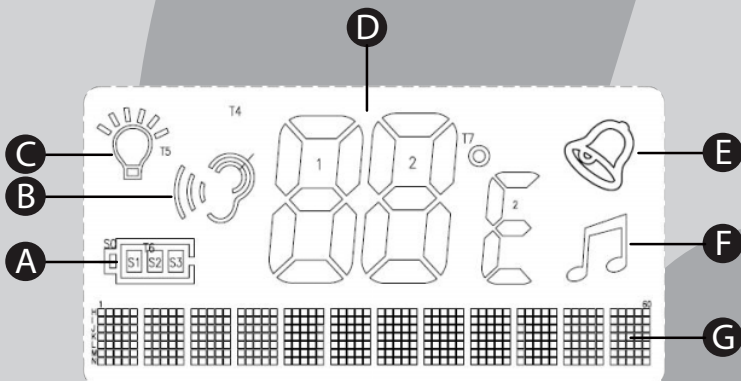

- A. Battery level indication
- B. Baby Unit sensitivity adjusting
- C. Night light on
- D. Temperature reading
- E. Alarm function on
- F. Lullaby is playing
- G. Date/Time & Information



Table of contents

- 1. Safety Instructions 6**
- 2. Getting started 7**
 - 2.1 Baby unit battery Installation 7
 - 2.2 Baby unit power supply 8
 - 2.3 Parent unit battery Installation 8
 - 2.4 Parent unit power supply 9
 - 2.5 Link 10
 - 2.6 Registration 11
 - 2.7 Paging 11
- 3. Using the MBP15 12**
 - 3.1 Volume adjustment 12
 - 3.1.1 Parent unit 12
 - 3.1.2 Baby unit 12
 - 3.2 Talk to your baby 12
 - 3.3 Menu operation 12
 - 3.4 Night Light 14
 - 3.4.1 Remote activation 14
 - 3.4.2 Local activation 14
 - 3.5 Lullaby 14
 - 3.5.1 Remote activation 14
 - 3.5.2 Local activation 15
 - 3.6 Voice Activation 15
 - 3.7 Sound alert 15
 - 3.7.1 Sound alert volume 16
 - 3.8 Temperature 16
 - 3.8.1 Temperature range 16
 - 3.8.2 Temperature alert 17
 - 3.8.3 Temperature unit (°C or °F) 17
 - 3.9 Clock 18
 - 3.9.1 Set Date and Time 18
 - 3.9.2 Hour Format 18
 - 3.10 Feed Time 19
 - 3.10.1 Set Feed Time 19
 - 3.10.2 Set Interval Time 19
 - 3.10.3 Set Alarm 20
 - 3.10.4 Alarm Volume 20
 - 3.11 Display language 20
- 4. Disposal of the device (environment) 21**
- 5. Cleaning 22**
- 6. Help 23**
- 7. General Information 25**



1. Safety Instructions

WARNING

This baby monitor is compliant with all relevant standards regarding electromagnetic fields and is, when handled as described in the User's Guide, safe to use. Therefore, always read the instructions in this User's Guide carefully before using the device.

- Adult assembly is required. Keep small parts away from children when assembling.
- This product is not a toy. Do not allow children to play with it.
- This baby monitor is not a substitute for responsible adult supervision.
- Keep this User's Guide for future reference.
- Do not place the baby unit or cables in the crib or within arm's reach of the baby (the unit should be at least 3 feet away).
- Keep the cords out of reach of children.
- Do not cover the baby monitor with a towel or blanket.
- Never use extension cords with power adaptors. Only use the power adaptors provided.
- Test the baby monitor before use. Become familiar with its functions.
- Do not use the baby monitor near water.
- Do not install the baby monitor near a heat source.
- Only use the chargers and power adaptors provided. Do not use other chargers or power adaptors as this may damage the device and batteries.
- Only insert batteries of the same type. Never use ordinary, non-rechargeable batteries in the parent unit. Insert batteries with the right polarity (indicated in the battery compartment).
- Do not touch the charger or plug contacts with sharp or metal objects.

CAUTION

Risk of explosion if battery is replaced by an incorrect type. Dispose of used batteries according to the instructions.

2. Getting started

2.1 Baby unit battery Installation

The baby unit can be used either with 3 AA size batteries (non-rechargeable batteries recommended) or the household mains electricity. **The baby unit has no charging function!**

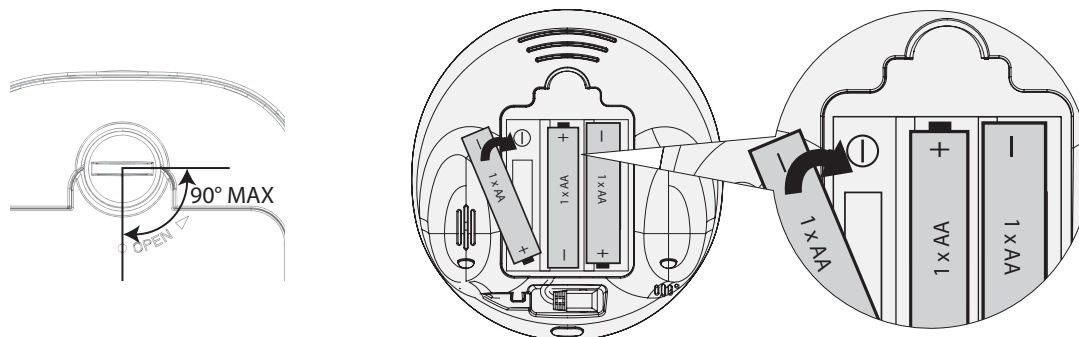



IMPORTANT

The non-rechargeable batteries for the Baby unit are not supplied with your product. We recommend the batteries to be installed before use, so that the unit continues to work in the event of a mains power failure.

1. Using a screwdriver, turn the screw of the battery cover on the back of the baby unit 90 degrees in a counterclockwise direction. Remove the battery cover.

NOTE

*Do not try to rotate the screw further than the position **OPEN**.*

2. Install 3 AA non-rechargeable batteries following the polarity as shown.
3. Close the battery compartment and turn the screw 90 degrees back in a clockwise direction.
4. Press . The power LED will illuminate.
5. Press and hold  to switch off the baby unit.

NOTE

When the battery level is low, the power LED flashes and the baby unit emits a short warning tone once every minute.

WARNING

Do not mix old batteries with new ones.

Keep batteries away from small children.

Do not short-circuit batteries or dispose of in fire.

Remove the batteries if this device is not going to be used for a long period of time.



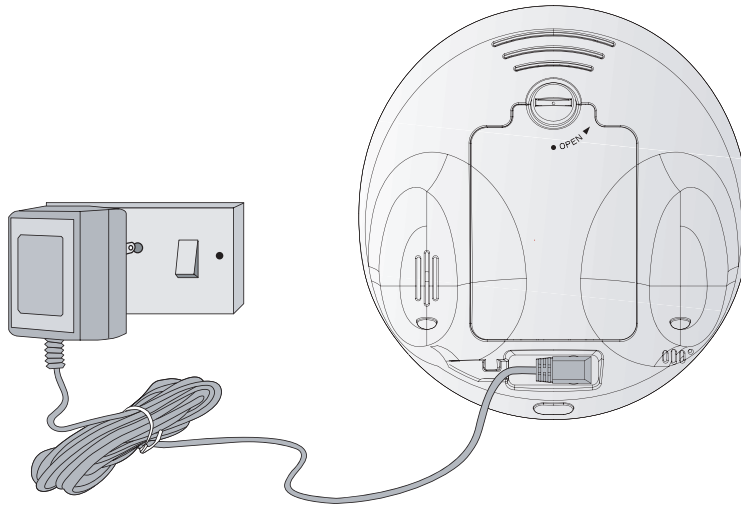

2.2 Baby unit power supply



1. Connect the small plug of the power adaptor to the power connector on the baby unit and the other end of the adaptor to the electrical outlet (110V/60Hz).

NOTE

Only use the enclosed adaptor (6V DC / 300mA).

2. Press . The power LED will illuminate.
3. Press and hold  to switch off the baby unit.

2.3 Parent unit battery Installation

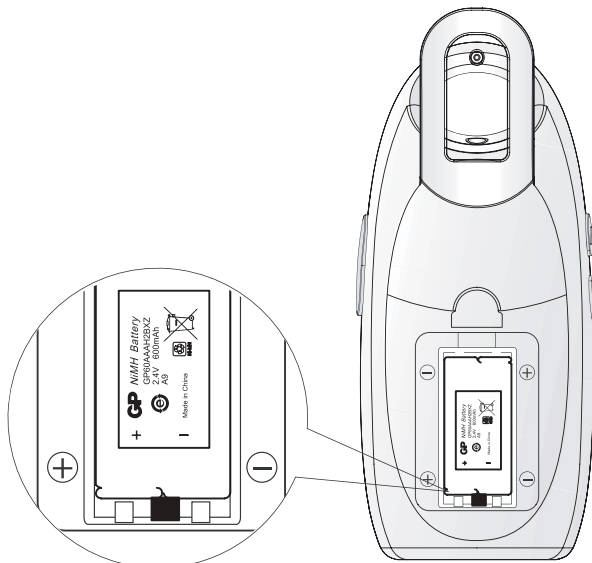

1. Turn the belt clip so that it is in the hanging position.



- Using a screwdriver, turn the screw on the back of the parent unit 90 degrees in a counterclockwise direction. Remove the battery cover.



NOTE

Do not try to rotate the screw further than the position OPEN.

- Install the enclosed 2.4V 600mAh Ni-MH rechargeable battery pack following the polarity as shown.

WARNING

Do not use non-rechargeable batteries for the Parent Unit. Risk of explosion if battery is replaced by an incorrect type. Dispose of used batteries according to the instructions.

- Close the battery compartment and tighten the screw in a clockwise direction.
- Press . The LCD display will illuminate.
- Press and hold  to switch off the parent unit.

NOTE

When the battery level is low, the  icon flashes on the LCD display and the parent unit emits a short warning tone once every minute.

2.4 Parent unit power supply

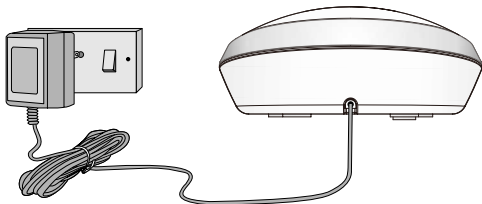

- Connect the power adaptor cable of the charger pod to the electrical outlet (110V/60Hz).

NOTE



Only use the enclosed adaptor (6V DC / 300mA).

- Place the parent unit on the charger. The red charging light illuminates.



NOTE

It takes about 15 hours to charge the unit.

3. Press . The LCD display will illuminate.
4. Press and hold  to switch off the parent unit.

2.5 Link

NOTE

Do not place the baby unit or cables in the crib or within arm's reach of the baby (the unit should be at least 3 feet away).

When using the baby monitor for the first time, it is advised to test the connection.



- Install the parent unit in the same room as the baby unit, but make sure there are at least 3 feet between the 2 units to avoid feedback howling.
- When both units are switched on, the parent unit will search for the baby unit.
- The green link LED on the parent unit will flash until the parent unit is connected with the baby unit.
Once the link is established, the LED will stop flashing.
- The sound captured by the microphone on the baby unit will be audible on the parent unit.
- The detected sound level is indicated by the LEDs near the top of the parent unit.
- When the sound reaches the maximum level, a beep will be heard.
- When the connection is established, move the parent unit to the room you want to monitor from, but within the operational range.
- When there is no connection or out of range, the parent unit emits a warning beep every 3 seconds and the green link LED on the parent unit will flash.
- Move the parent unit closer until the link is re-established.



2.6 Registration

The baby monitor is already pre-registered upon your purchase. You do not need to re-register it again unless the baby unit loses its link with the parent unit.

To re-register your baby monitor, follow the procedure below:

1. Switch off the baby unit mains power and remove any batteries from the baby unit. Then, remove the batteries from the parent unit.
2. Press and hold  while the baby unit mains power is switched back on, and keep holding it down until the night light flashes. The baby unit is in registration mode.
3. Press and hold  while the battery is replaced in the parent unit, and keep holding it down until the red sound LEDs flash. The parent unit is in registration mode.
4. Wait for the 2 units to search and establish the link.

When the registration is complete, the LEDs stop flashing and the parent unit emits a long beep.

2.7 Paging

If the parent unit is misplaced, press and hold  for 2 seconds on the baby unit.

The parent unit will emit a repeated beep tone for 30 seconds so that you can locate it.

Press any key on the parent unit to stop paging.

3. Using the MBP15

3.1 Volume adjustment

3.1.1 Parent unit

There are 5 volume levels on the parent unit, and a **Volume Off** setting.

- Press ▲ to increase the volume level.
- Press ▼ to decrease the volume level.

NOTE

When Volume Off is displayed, the sound detected (such as baby's cries) is indicated by the LEDs near the top of the unit.

3.1.2 Baby unit

- Press ▲ to increase the volume level.
- Press ▼ to decrease the volume level.

NOTE



The volume level of the baby unit determines the volume when you talk to the baby and when playing a lullaby.

3.2 Talk to your baby

You can talk to your baby through the baby monitor.

1. Press and hold  on the parent unit to talk to your baby.
2. Release the button to stop talking.

3.3 Menu operation

1. Press  on the parent unit to enter the menu.
2. Press ▲ or ▼ to scroll through the menu options.
3. Press  to select the desired setting.

Press  to go back one level or exit the menu.

TIPS

If no button is pressed for about 20 seconds, the display will return to standby mode.







Menu map

Main Menu	Sub menu 1	Sub menu 2
Night Light	On? / Off?	
Lullaby	Play? / Stop? Select New	Twinkle Silent Night Minuet in G Danny Boy Blue Danube Play All
Sensitivity	<i>Adjust Baby unit microphone sensitivity level (5 levels)</i>	
Sound Alert	On? / Off? Volume	<i>Adjust volume level</i>
Temperature	Set Range Temp Alert	<i>Set temperature range</i> Alert On? / Alert Off? Volume
	Degree F? / Degree C?	
Clock	Set Time	Year / Month / Day / Hour / Minute
	Hour Format	24 Hrs? / 12Hrs?
Feed Time	Set Time Set Interval Alarm	Hour / Minute Hour/Minute On? / Off? Volume
Language	<i>Select language (country-dependent)</i>	



3.4 Night Light

3.4.1 Remote activation

1. Press  on the parent unit, **Night Light** is displayed.
 2. Press . **On?** is displayed.
 3. Press  again to activate the night light on the baby unit.
- Press  to exit the menu.

TIPS

*To remotely deactivate the night light, follow the same steps, but select **Off?**.*













3.4.2 Local activation

Press  on the baby unit to switch the night light on or off.

3.5 Lullaby

5 lullabies can be played on the baby unit.

3.5.1 Remote activation

1. Press  on the parent unit, **Night Light** is displayed.
 2. Press  or  until **Lullaby** is displayed.
 3. Press . **Play?** is displayed.
 4. Press  or  to select **Select New**.
 5. Press  to confirm.
 6. Press  or  to select the desired lullaby or select **Play All** to play all lullabies one after the other.
 7. Press  to confirm.
 8. Press . **Play?** is displayed.
 9. Press  to start playing the lullabies.
- Press  to exit lullaby setting.

TIPS

*To remotely deactivate the Lullaby, follow the same steps, but select **Stop**.*

NOTE

The volume level of the played lullaby can only be adjusted on the baby unit. The baby unit will remember the last set volume level (see “3.1 Volume adjustment”).





If you press  on the parent unit, the lullaby will stop automatically.

3.5.2 Local activation

1. Press ►|| on the baby unit. The last selected lullaby is played.
2. Press ▲ to increase the volume level or ▼ to decrease the volume level.
3. Press 🎵 to change lullaby.
4. Press ►|| to stop playing.





3.6 Voice Activation

The sound detection sensitivity level (VOX) of the Baby Monitor can be adjusted. If the baby is a quiet sleeper, the sensitivity level can be increased so that minor disturbances can be detected and transmitted to the parent unit.

1. Press  on the parent unit, **Night Light** is displayed.
 2. Press ▲ or ▼ until **Sensitivity** is displayed.
 3. Press  to confirm.
 4. Press ▲ or ▼ to select the desired VOX sensitivity.
 5. Press  to confirm.
- Press  to exit the menu.

3.7 Sound alert

The level of sound detected (such as baby's cries) is indicated by the number of volume indicator LEDs on top of the display. Even when the volume of the parent unit is set to **Volume Off**, a beep can be emitted to alert you that the sound level has reached the 'red' zone.











1. Press  on the parent unit, **Night Light** is displayed.
 2. Press ▲ or ▼ until **Sound Alert** is displayed.
 3. Press . **On?** is displayed.
 4. Press  to confirm.
- Press  to exit the menu.

TIPS

*To deactivate Sound alert, follow the same steps, but select **Off?**.*



3.7.1 Sound alert volume













1. Press  on the parent unit, **Night Light** is displayed.
 2. Press  or  until **Sound Alert** is displayed.
 3. Press  to confirm.
 4. Press  or  until **Volume** is displayed.
 5. Press  to confirm.
 6. Press  or  to select the desired volume.
 7. Press  to confirm.
- Press  to exit the menu.

3.8 Temperature

In standby mode, the room temperature where the baby unit is placed is displayed on the parent unit.

3.8.1 Temperature range

When the room temperature has exceeded the upper or lower limit, it will be indicated on the display screen.

1. Press  on the parent unit, **Night Light** is displayed.
 2. Press  or  until **Temperature** is displayed.
 3. Press . **Set Range** is displayed.
 4. Press  to confirm.
 5. Press  or  to select the desired upper limit (max 28°C).
 6. Press  to confirm.
 7. Press  or  to select the desired lower limit (min 17°C).
 8. Press  to confirm.
- Press  to go back one level or exit the menu.









NOTE

*When the limits are exceeded, the display will show **High** or **Low** and the current temperature will flash. If you have set the alert tone to on, you will also be alerted by a warning beep when the limit is exceeded.*



3.8.2 Temperature alert













When the temperature limits are exceeded, a double beep tone can be emitted to alert you.

1. Press  on the parent unit, Night Light is displayed.
2. Press  or  until Temperature is displayed.
3. Press  to confirm.
4. Press  or  until Temp Alert is displayed.
5. Press . Alert On? is displayed.
6. Press  to activate the temperature alert.

TIPS







To deactivate the alert, follow the same steps, but select Alert Off?.

3.7.2.1 Temperature alert volume

1. Press  on the parent unit, Night Light is displayed.
2. Press  or  until Temperature is displayed.
3. Press  to confirm.
4. Press  or  until Temp Alert is displayed.
5. Press  to confirm.
6. Press  or  until Volume is displayed.
7. Press  to confirm.
8. Press  or  to select the desired volume.
9. Press  to confirm.

Press  to go back one level or exit the menu.

3.8.3 Temperature unit (°C or °F)

1. Press  on the parent unit, Night Light is displayed.
2. Press  or  until Temperature is displayed.
3. Press  to confirm.
4. Press  or  until Degree F? is displayed.
5. Press  to confirm.

Press  to go back one level or exit the menu.

TIPS

To set the unit to °C, follow the same steps, but select Degree C?.























3.9 Clock

The display screen on the parent unit shows the date and time (default on power up 01/01 12:00), but will need to be set to the correct date and time. The time can be shown in either 24 or 12 hour clock format (your monitor is pre-set to show the 24 hour clock format).









If you wish to use the Feed Time feature, you will need to set the clock.

3.9.1 Set Date and Time

1. Press  on the parent unit, **Night Light** is displayed.
2. Press  or  until **Clock** is displayed.
3. Press . **Set Time** is displayed.
4. Press . **Year** is displayed.
5. Press  or  to select the year.
6. Press . **Month** is displayed.
7. Press  or  to select the month.
8. Press . **Day** is displayed.
9. Press  or  to select the day.
10. Press . **Hour** is displayed.
11. Press  or  to select the hour.
12. Press . **Minute** is displayed.
13. Press  or  to select the minutes.
14. Press  to confirm.

Press  to go back one level or exit the menu.

3.9.2 Hour Format

1. Press  on the parent unit, **Night Light** is displayed.
2. Press  or  until **Clock** is displayed.
3. Press  to confirm.
4. Press  or  until **Hour Format** is displayed.
5. Press . **12Hrs?** is displayed.
6. Press  to confirm.

Press  to go back one level or exit the menu.

TIPS

*To set the unit to 24 hour clock format, follow the same steps, but select **24Hrs?**.*















3.10 Feed Time

If your baby follows a regular nursing routine, you may wish to set your baby monitor to alert you when your baby's nursing is to begin. You can set your baby's next nursing time and the subsequent nursing times based on the interval time between them.

First, you will need to ensure that you have set the date and time on your parent unit.













3.10.1 Set Feed Time

1. Press , **Night Light** is displayed.
2. Press  or  until **Feed Time** is displayed.
3. Press . **Set Time** is displayed.
4. Press . **Hour** is displayed.
5. Press  or  to select the hour.
6. Press . **Minute** is displayed.
7. Press  or  to select the minutes.
8. Press  to confirm.

Press  to go back one level or exit the menu.

3.10.2 Set Interval Time









When setting the interval time, please include the time it takes to nurse your baby.

1. Press , **Night Light** is displayed.
2. Press  or  until **Feed Time** is displayed.
3. Press  to confirm.
4. Press  or  until **Set Interval** is displayed.
5. Press . **Hour** is displayed.
6. Press  or  to select the interval hour.
7. Press . **Minute** is displayed.
8. Press  or  to select the minute interval.
9. Press  to confirm.

Press  to go back one level or exit the menu.

3.10.3 Set Alarm

The alarm must be turned on if you want an alert at the feed time and subsequent intervals.













1. Press , **Night Light** is displayed.
2. Press  or  until **Feed time** is displayed.
3. Press  to confirm.
4. Press  or  until **Alarm** is displayed.
5. Press . **On?** is displayed.
6. Press  to confirm, and the Alarm icon will show on the parent unit display.

Press  to go back one level or exit the menu.

TIPS







*To deactivate the Alarm, follow the same steps, but select **Off?***

3.10.4 Alarm Volume

1. Press  on the parent unit, **Night Light** is displayed.
2. Press  or  until **Feed Time** is displayed.
3. Press  to confirm.
4. Press  or  until **Alarm** is displayed.
5. Press  to confirm.
6. Press  or  until **Volume** is displayed.
7. Press  to confirm.
8. Press  or  to select the volume of the beep tone.
9. Press  to confirm.

Press  to go back one level or exit the menu.

3.11 Display language

1. Press  on the parent unit, **Night Light** is displayed.
2. Press  or  until **Language** is displayed
3. Press . The current language is displayed.
4. Press  or  to select the desired language.
5. Press  to confirm.

Press  to exit the menu.



4. Disposal of the device (environment)

At the end of the product lifecycle, you should not dispose of this product with normal household waste, but take the product to a collection point for the recycling of electrical and electronic equipment. The symbol on the product, user's guide and/or box indicates this.



Some of the product materials can be re-used if you take them to a recycling point. By reusing some parts or raw materials from used products you make an important contribution to the protection of the environment.

Please contact your local authorities in case you need more information on the collection points in your area.

Dispose of the batteries in an environmentally-friendly manner according to your local regulations.

5. Cleaning

Clean the MBP15 with a slightly damp cloth or with an anti-static cloth. Never use cleaning agents or abrasive solvents.

Cleaning and care

- Do not clean any part of the product with thinners or other solvents and chemicals — this may cause permanent damage to the product which is not covered by the Warranty. When necessary, clean it with a damp cloth.
- Keep your MBP15 away from hot, humid areas or strong sunlight, and don't let it get wet.
- Every effort has been made to ensure high standards of reliability for your MBP15. However, if something does go wrong, please do not try to repair it yourself — contact Customer Service for assistance.

6. Help

Charging

The  is not scrolling when the parent unit is placed on the charger pod

- Bad battery contact - move the parent unit slightly.
- Dirty contact - Clean the battery contacts on the parent unit and charger pod with a cloth moistened with alcohol.
- Battery is full - no need to charge.
- Make sure the charger pod is correctly plugged in to a 110VAC, 60Hz mains power socket and that the socket is switched on.
- Make sure the 2.4V 600mAh Ni-MH rechargeable battery pack are properly inserted and with the polarity correct, in the battery compartment of the parent unit .

Display

No display

- Try recharging or replacing the batteries.
- Reset the units. Remove the batteries from the parent unit, wait for about 15 seconds and then replace them.
- Is the unit turned on?
Press and release  on the side of the parent unit to turn it on.

Registration

If the baby unit has lost its link with the parent unit

- Try recharging or replacing the batteries.
- If the baby unit is too far away it may be going out of range, so move the baby unit closer to the parent unit.
- Reset the units. Remove the batteries from the parent unit, wait for about 15 seconds and then replace them. Allow up to one minute for the baby unit and the parent unit to synchronize.
- See “2.6 Registration” if there is a need to re-register the units.



Interference

Noise interference on your parent unit

- Your baby and parent units may be too close. Move them further away from each other.
- Make sure there are at least 3 feet between the 2 units to avoid feedback howling.
- If the baby unit is too far away it may be going out of range, so move the baby unit closer to the parent unit.
- Make sure the baby and parent units are not near other electrical equipment, such as a television, computer or cordless/mobile telephone.

7. General Information

If your product is not working properly....

1. Read this User's Guide or the Quick Start Guide.
2. Visit our website:
<http://www.motorola.com>
3. Contact Customer Service at US 1-888-331-3383 or
Canada 905-831-6555.

To order a replacement battery, contact customer service or visit our website.

Consumer Products and Accessories purchased in the United States or Canada

What Does this Warranty Cover?

Subject to the exclusions and limitations contained below, Binatone Electronics International LTD. warrants the Motorola branded consumer products that it manufactures ("Products") and the Motorola branded or certified accessories sold for use with these Products that it manufactures ("Accessories") to be free from defects in materials and workmanship under normal consumer usage for the period(s) outlined below. This limited warranty is a consumer's exclusive remedy, and only applies as follows to new Motorola branded Products and Accessories manufactured by Binatone Electronics International LTD., and purchased by consumers in the United States or Canada, which are accompanied by this written warranty:

Who is covered?

This warranty covers only the first consumer purchaser, and is not transferable.



What will BINATONE ELECTRONICS INTERNATIONAL LTD. do?

BINATONE ELECTRONICS INTERNATIONAL LTD., at its sole option, will at no charge repair, replace or refund the purchase price of any Products or Accessories that does not conform to this warranty. Binatone Electronics International LTD. may use functionally equivalent reconditioned/ refurbished/ pre-owned or new Products, Accessories or parts in such repair or replacement and any Products, Accessories or parts removed or being replaced under this warranty become the property of Binatone Electronics International LTD.

What Other Limitations Are There?

ANY IMPLIED WARRANTIES OR CONDITIONS IRRESPECTIVE OF WHETHER THEY ARE IMPOSED BY LAW OR OTHERWISE, INCLUDING WITHOUT LIMITATION THE IMPLIED WARRANTIES OF MERCHANTABILITY AND FITNESS FOR A PARTICULAR PURPOSE, SHALL BE LIMITED TO THE DURATION OF THIS LIMITED WARRANTY, OTHERWISE THE REPAIR, REPLACEMENT, OR REFUND AS PROVIDED UNDER THIS EXPRESS LIMITED WARRANTY IS THE EXCLUSIVE REMEDY OF THE CONSUMER, AND IS PROVIDED IN LIEU OF ALL WARRANTIES AND MOTOROLA AND BINATONE ELECTRONICS INTERNATIONAL LTD. MAKES NO OTHER WARRANTIES OR CONDITIONS, EXPRESS OR IMPLIED. IN NO EVENT SHALL MOTOROLA OR BINATONE ELECTRONICS INTERNATIONAL LTD. BE LIABLE, WHETHER UNDER THIS LIMITED WARRANTY OR IN CONTRACT OR TORT (INCLUDING NEGLIGENCE OR STRICT PRODUCT LIABILITY) OR OTHERWISE FOR DAMAGES OR CLAIMS IN EXCESS OF THE PURCHASE PRICE OF THE PRODUCT OR ACCESSORY, OR FOR ANY INDIRECT, INCIDENTAL, SPECIAL OR CONSEQUENTIAL DAMAGES OF ANY KIND, OR LOSS OF REVENUE, SAVINGS OR PROFITS, LOSS OF BUSINESS, LOSS OF PROGRAMS DATA INFORMATION (WHETHER CONFIDENTIAL PROPRIETARY OR PERSONAL IN NATURE OR OTHERWISE) OR OTHER FINANCIAL LOSS ARISING OUT OF OR IN CONNECTION WITH THE ABILITY OR INABILITY TO USE THE PRODUCTS OR



ACCESSORIES AND BINATONE ELECTRONICS INTERNATIONAL LTD. SHALL UNDER NO CIRCUMSTANCES BE LIABLE FOR ANY CLAIMS OR DEMANDS MADE BY ANY THIRD PARTY OR MADE BY YOU ON BEHALF OF ANY THIRD PARTY TO THE FULL EXTENT THESE DAMAGES OR CLAIMS MAY BE DISCLAIMED BY LAW.

Some states, countries or jurisdictions do not allow the limitation or exclusion of incidental or consequential damages, or limitation on the length of an implied warranty, so the above limitations or exclusions may not apply to you in such states, countries or jurisdictions. This warranty gives you specific legal rights, and you may also have other rights that vary from state to state or from one country/jurisdiction to another.

Products or Accessories Covered	Length of Coverage
Consumer Products	One (1) year from the date of purchase by the first consumer purchaser of the product.
Consumer Accessories	Ninety (90) days from the date of purchase by the first consumer purchaser of the accessory.
Consumer Products and Accessories that are Repaired or Replaced	The balance of the original warranty or for ninety (90) days from the date returned to the consumer, whichever is longer.

Exclusions

Normal Wear and Tear. Periodic maintenance, repair and replacement of parts due to normal wear and tear are excluded from coverage.

Batteries. Only batteries whose fully charged capacity falls below 80% of their rated capacity and batteries that leak are covered by this limited warranty. Battery life and the changes in battery capacity with time or use are excluded from this warranty.

Abuse & Misuse. Defects or damage that result from: (a) improper or unreasonable use, operation, storage, misuse or abuse, accident or neglect or other external cause, such as physical damage (cracks,

scratches, etc.) to the surface of the product resulting from misuse; (b) your failure to follow or operate outside the usage parameters stated in the user instructions that came with the Products or Accessories; (c) contact with liquid, water, rain, extreme humidity or heavy perspiration, sand, dirt or the like, extreme heat, or food; (d) use of the Products or Accessories for commercial purposes or subjecting the Product or Accessory to abnormal usage or conditions; or (e) other acts or omissions which are not the fault or neglect of Motorola or Binatone Electronics International LTD., are excluded from coverage.

Use of Non-Motorola branded Products and Accessories. Defects or damage that result from the use of Non-Motorola branded or certified Products or Accessories or other peripheral equipment are excluded from coverage.

Unauthorized Service or Modification. Defects or damages resulting from service, testing, adjustment, installation, maintenance, alteration, or modification in any way by someone other than Motorola, Binatone Electronics International LTD. or its authorized service centers, are excluded from coverage.

Altered Products. Products or Accessories with (a) serial numbers or date tags that have been removed, altered or obliterated; (b) broken seals or that show evidence of tampering; (c) mismatched board serial numbers; or (d) nonconforming or non-Motorola branded housings, or parts, are excluded from coverage.

Communication Services. Defects, damages, or the failure of Products or Accessories due to any communication service or signal you may subscribe to or use with the Products or Accessories is excluded from coverage.

How to Obtain Warranty Service or Other Information?

To obtain service or information, please call:

US: 1-888-331-3383

CANADA: 905-831-6555

You will receive instructions on how to ship the Products or Accessories, the shipment of which shall be at your own risk and expense, to a BINATONE ELECTRONICS INTERNATIONAL LTD. Authorized Repair Center. To obtain service, you must include: (a) a copy of your receipt, bill of sale or other comparable proof of purchase of the Products or Accessories showing the date of purchase; (b) a written description of the problem; and, most importantly; (c) your address and telephone number.

These terms and conditions constitute the complete warranty agreement between you and BINATONE ELECTRONICS INTERNATIONAL LTD. regarding the Products or Accessories purchased by you, and supersede any prior agreement or representations, including representations made in any literature publications or promotional materials issued by BINATONE ELECTRONICS INTERNATIONAL LTD. or representations made by any agent employee or staff of BINATONE ELECTRONICS INTERNATIONAL LTD., that may have been made in connection with the said purchase.

FCC and IC regulations

FCC Part 15

NOTE: This equipment has been tested and found to comply with the limits for a Class B digital device, pursuant to Part 15 of the Federal Communications Commission (FCC) rules. These limits are designed to provide reasonable protection against harmful interference in a residential installation. This equipment generates, uses and can radiate radio frequency energy and, if not installed and used in accordance with the instructions, may cause harmful interference to radio communications. However, there is no guarantee that interference will not occur in a particular installation. If this equipment does cause harmful interference to radio or television reception, which can be determined by turning the equipment off and on, the user is encouraged to try to correct the interference by one or more of the following measures:

- Reorient or relocate the receiving antenna.
- Increase the separation between the equipment and receiver.

- Connect the equipment into an outlet on a circuit different from that to which the receiver is connected.
 - Consult the dealer or an experienced radio/TV technician for help.
- Changes or modifications to this equipment not expressly approved by the party responsible for compliance could void the user's authority to operate the equipment.

This device complies with Part 15 of the FCC rules. Operation is subject to the following two conditions: (1) this device may not cause harmful interference, and (2) this device must accept any interference received, including interference that may cause undesired operation. Privacy of communications may not be ensured when using this device.

To ensure safety of users, the FCC has established criteria for the amount of radio frequency energy that can be safely absorbed by a user or bystander according to the intended usage of the product. This product has been tested and found to comply with the FCC criteria. The Baby unit shall be installed and used such that parts of the user's body other than the hands are maintained at a distance of approximately 20 cm (8 inches) or more.

This Class B digital apparatus complies with Canadian ICES-003.

WARNING

Changes or modifications to this equipment not expressly approved by the party responsible for compliance could void the user's authority to operate the equipment.

Industry Canada

Operation is subject to the following two conditions: (1) this device may not cause harmful interference, and (2) this device must accept any interference, including interference that may cause undesired operation of the device.

The term "IC: " before the certification/registration number only signifies that the Industry Canada technical specifications were met.

This product meets the applicable Industry Canada technical specifications.

RENSEIGNEMENTS RELATIFS AUX RÈGLEMENTS DE LA COMMISSION FÉDÉRALE DES COMMUNICATIONS 'FCC' ET D'INDUSTRIE Canada 'IC'

Article 15 des règlements du FCC

AVIS: Cet équipement a été testé et s'est révélé conforme aux limites d'un appareil numérique de classe B, conformément à la Section 15 du règlement de la Federal Communications Commission (FCC). Ces limites sont conçues pour offrir une protection raisonnable contre toute interférence nuisible sur une installation résidentielle. Cet appareil génère, utilise et peut émettre des fréquences radio et s'il n'est pas installé selon les instructions, peut nuire aux radiocommunications. Toutefois, rien ne garantit que des parasites ne surviendront pas dans une installation particulière. Si cet appareil cause des interférences nuisibles à la réception du téléviseur ou de la radio, ce que vous pouvez déterminer en mettant votre appareil en et hors fonction, nous vous invitons à essayer l'une des mesures correctives suivantes :

- Réorientez l'antenne de réception.
- Éloignez l'appareil du composant qui reçoit les ondes.
- Branchez l'appareil dans une prise de courant CA différente de celle du composant qui reçoit les ondes.
- Au besoin, consultez votre marchand électronique ou un technicien spécialisé dans le service des radios/téléviseurs pour des suggestions supplémentaires.

Toute modification ou changement effectué à cet appareil sans l'accord des parties responsables de l'homologation peut retirer à l'utilisateur son droit d'utiliser l'appareil.

Cet appareil est conforme à l'article 15 de la FCC. Le fonctionnement est soumis aux deux conditions suivantes: (1) Cet appareil ne doit pas causer d'interférences nuisibles et; (2) Il doit pouvoir supporter les parasites qu'il reçoit, incluant les parasites pouvant nuire à son fonctionnement. La confidentialité des communications peut ne pas être assurée avec cet appareil.

Afin de garantir la sécurité des utilisateurs, la FCC a établi les critères relatifs à l'énergie générée par les fréquences radio pouvant être absorbée en toute sécurité par un utilisateur ou par quelqu'un se trouvant à proximité, dépendamment de l'utilisation prévue du produit. Ce produit a été testé et s'avère conforme aux normes de la FCC. L'unité du bébé devra être installée et utilisée de manière à ce que le corps de l'utilisateur, à l'exception des mains, soit toujours à une distance d'environ 20 cm (8 po.) ou plus.

Cet appareil numérique de la classe B est conforme à la norme NMB-003 du Canada.

AVERTISSEMENT

Tout changement ou modification à cet équipement, non expressément autorisé par la partie responsable de la conformité, pourrait annuler l'autorisation donnée à l'utilisateur d'utiliser cet équipement.

Industrie Canada

Le fonctionnement est soumis aux deux conditions suivantes : (1) Cet appareil ne doit pas causer d'interférences nuisibles et; (2) Cet appareil accepte toute les interférences dont celles qui pourraient provoquer le fonctionnement involontaire de l'appareil.

L'abréviation 'IC' se trouvant avant cette homologation signifie que la certification fut effectuée selon une déclaration de conformité spécifiant que les normes d'Industrie Canada ont été rencontrées.

Cet appareil est conforme aux spécifications techniques d'Industrie Canada.



Technical Specifications

Frequency range	2.4GHz to 2.4835GHz (bandwidth = 83.5MHz)
Operating range	Extended range up to 950 feet* *Based on unobstructed line of sight. Actual range will vary depending on surroundings.
Electrical power	Parent unit: 2.4V 600mAh Ni-MH rechargeable battery pack (Supplier: GPI, Model: GP60AAAH2BXZ) Baby unit: Input — 100-240VAC, 50/60Hz (USA plug); Output — 6VDC, 300 mA (Model: Kings, KSS05-060-0300U) OR 3 AA non-rechargeable batteries (<i>Note: Batteries are not included</i>) Charger pod: Input — 100-240VAC, 50/60Hz (USA plug); Output — 6VDC, 300 mA (Model: Kings, KSS05-060-0300U)



MOTOROLA

Manufactured, distributed or sold by Binatone Electronics International LTD., official licensee for this product. MOTOROLA and the Stylized M Logo, and other Motorola trademarks and trade dress are owned by Motorola, Inc. and are used under license from Motorola, Inc. MOTOROLA and the Stylized M Logo are registered in the US Patent & Trademark Office. All other product or service names are the property of their respective owners.

© Motorola, Inc. 2009. All rights reserved.



Version 1.0

Printed in China

