



MOTOROLA

USER'S GUIDE

MBP30

BABY MONITOR

USER'S GUIDE

The features described in this user's guide are subject to modifications without prior notice.

V 0.1



Welcome...

to your new Motorola Baby Monitor!

Thank you for purchasing the MBP30. Now you can see and hear your baby sleeping in the other room or you can monitor your older children in their playroom.

Please retain your original dated sales receipt for your records. For warranty service of your Motorola product, you will need to provide a copy of your dated sales receipt to confirm warranty status. Registration is not required for warranty coverage.

For product related questions, please call:

US 1-888-331-3383 or Canada 905-831-6555

On the Web: www.motorola.com

This User's Guide provides you with all the information you need to get the most from your product.

Before you can use the baby monitor, you'll need to insert and fully charge the battery on the Parent unit. Please read the Safety Instructions on page 6 before you install the units.

Got everything?

- 1 x Parent unit
- 1 x Baby unit
- 1 x Rechargeable Ni-MH battery pack for the Parent unit
- 1 x Power adapter for the Parent unit
- 1 x Power adapter for the Baby unit

IMPORTANT



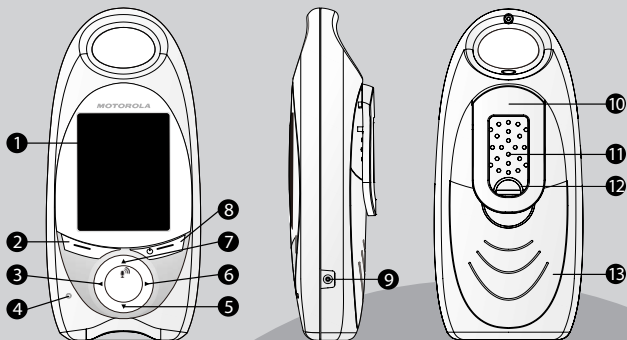

The non-rechargeable batteries for the Baby unit are not supplied with your product. We recommend the batteries to be installed before use, so that the unit continues to work in the event of a mains power failure.

Overview of your Parent unit



1. Display
2. Menu key
3. Left key
4. Microphone
5. Down key
6. Right key
7. Up/Talk key
8. Power/Channel/Enter key
9. Power adapter connector
10. Belt clip
11. Speaker
12. Battery cover screw
13. Battery cover

Parent unit menu icons

	Adjust contrast level of the LCD
	Turn the night vision on or off
	Adjust the voice activation level
	Set video timer to switch off the LCD
	Pair a camera unit

Overview of your *Baby unit*

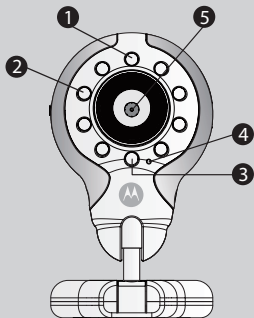

1. Power LED
2. Infrared LEDs
3. Light sensor
4. Microphone
5. Camera lens

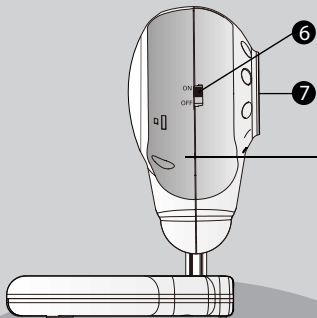

6. On/Off switch
7. Speaker



Table of contents

1. Safety Instructions	6
2. Getting started	7
2.1 Baby unit power supply	7
2.2 Parent unit battery installation	8
2.3 Parent unit power supply	9
2.4 Registration	10
3. Using the Baby Monitor MBP30	11
3.1 Setting up	11
3.2 Setting up	12
3.3 Selecting camera channel	12
3.4 Pairing camera channels	12
3.5 Night vision	13
3.6 Talk function	13
3.7 Adjusting the volume of the parent unit	13
4. MBP30 Parent Unit Menu Options	13
4.1 Brightness	13
4.2 Night Vision	13
4.3 Voice Activation	14
4.4 Video Timer	14
5. Disposal of the device (environment)	15
6. Cleaning	15
7. Help	16
8. General Information	16
9. Wall mounting instructions	25



1. Safety Instructions

WARNING

This baby monitor is compliant with all relevant standards regarding electromagnetic fields and is, when handled as described in the User's Guide, safe to use. Therefore, always read the instructions in this User's Guide carefully before using the device.

- Adult assembly is required. Keep small parts away from children when assembling.
- This product is not a toy. Do not allow children to play with it.
- This baby monitor is not a substitute for responsible adult supervision.
- Keep this user's guide for future reference.
- Do not place the baby unit or cables in the crib or within arm's reach of the baby (the unit should be at least 3 feet away).
- Keep the cords out of reach of children.
- Do not cover the baby monitor with a towel or blanket.
- Never use extension cords with power adaptors. Only use the power adaptors provided.
- Test the baby monitor before use. Become familiar with its functions.
- Do not use the baby monitor near water.
- Do not install the baby monitor near a heat source.
- Only use the chargers and power adaptors provided. Do not use other chargers or power adaptors as this may damage the device and battery pack.
- Only insert battery pack of the same type.
- Do not touch the charger or plug contacts with sharp or metal objects.

CAUTION

Risk of explosion if battery is replaced by an incorrect type. Dispose of used batteries according to the instructions.

2. Getting started

2.1 Baby unit power supply

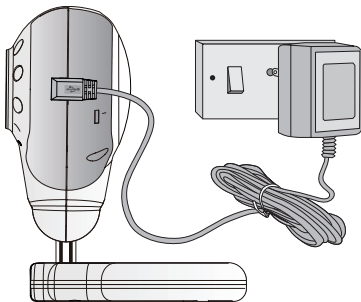

1. Connect the small plug of the power adaptor to the baby unit and the other end to the electrical outlet (110V/60Hz).

NOTE



Only use the enclosed power adaptor (5V DC / 500mA).

2. Slide the power switch to the ON position. The power LED will light up in green.
3. To switch off the baby unit, slide the power switch to OFF position.

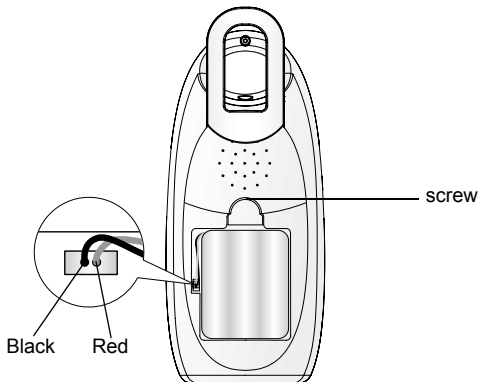

2.2 Parent unit battery Installation



1. Turn the belt clip so that it is in the hanging position.
 2. Loosen the screw in a counterclockwise direction using a small screwdriver. Remove the battery cover.
 3. Insert the wire tab of the rechargeable battery pack into the contact slot as shown above and fit the battery pack into the compartment.
 4. Close the battery compartment and tighten the screw in a clockwise direction.
 5. Press  to switch ON the parent unit. The LCD screen illuminates.
- *It will take a few seconds to start up the unit.*
 6. Press and hold  to switch OFF the parent unit.
- The battery icon  indicates that the battery pack is low and needs to be recharged. The battery pack takes about 15 hours to charge fully.



2.3 Parent unit power supply

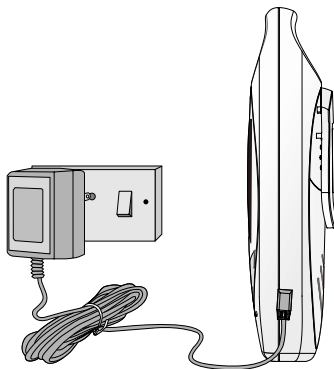

IMPORTANT

We recommend the rechargeable battery pack to be installed before use, so that the unit continues to work in the event of a mains power failure.

1. Connect the small plug of the power adaptor to the parent unit and the other end to the electrical outlet (110V/60Hz)

NOTE

Only use the enclosed power adaptor (5V DC / 1000mA).

2. The LCD screen illuminates and starts up automatically after a few seconds.
3. Press and hold  to switch OFF the parent unit.

NOTE

Once the baby and parent units are switched on, the display on the parent unit will show the video captured by the baby unit.







When there is no connection or out of range, the  icon on the LCD display will flash and the parent unit will beep continuously. Move the parent unit closer to the baby unit until the link is re-established.



2.4 Registration

The baby monitor is already pre-registered upon your purchase. You do not need to re-register it again unless the baby unit loses its link with the parent unit. Please check that you have selected the correct channel that was linked to your baby unit before you attempt to re-register your unit.

To re-register your baby monitor, follow the procedure below:

1. Switch off the camera and remove the small power plug from the camera. Then, remove the battery pack from the parent unit and switch off the mains power.
2. When the battery pack is replaced in the Parent unit with the mains power switched back on, the LCD screen illuminates and starts up automatically.
3. Press  to enter menu mode.
4. Press  or  until  is selected on the LCD screen.
5. Press  or  to select the camera channel you wish to pair. There are up to 4 camera channels available for pairing.
6. Switch on the camera and press  on the Parent unit to start pairing. **Pairing** is displayed as the Parent unit search for a camera device.

Wait for 16 seconds for the parent unit to locate the camera and map it to the current selected channel. The pairing is complete when the display screen on the parent unit captures the video from the baby unit's camera.

If no camera is found, **No Device found** will be displayed on the LCD screen. Switch the camera off and on to try again.



3. Using the Baby Monitor MBP30

3.1 Setting up

- Place the camera in a convenient location (for e.g. on a table) and point the lens of the camera towards the area you want to monitor.
- Tilt the head of the baby unit up or down to your desired position until the parent unit gets a good reception of the baby.

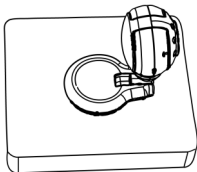
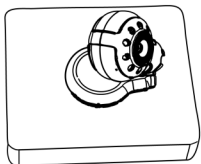
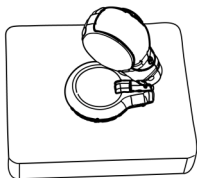
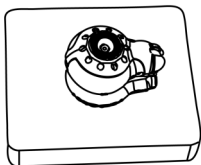

- To wall mount your camera, see “9. Wall mounting instructions” for more details.
- To use your video monitor baby and parent unit together, you must be able to establish a radio link between them, and the range will be affected by environmental conditions.
- Any large metal object, like a refrigerator, a mirror, a filing cabinet, metallic doors or reinforced concrete, between the baby and parent unit may block the radio signal.



- The signal strength may also be reduced by other solid structures, like walls, or by radio or electrical equipment, such as TV's, computers, cordless or mobile phones, fluorescent lights or dimmer switches.
- Use of other 2.4GHz products, such as wireless networks, Bluetooth systems or microwave ovens may cause interference with this product, so keep the baby monitor away from these types of products, or turn them off if they appear to be causing interference.
- If the signal is poor, try moving the parent and/or the baby unit to different positions in the rooms.

NOTE

Do not place the camera within baby's reach!

3.2 Setting up

- Place the camera in a convenient location and point the lens of the camera towards the area you want to monitor.
- Tilt the head of the baby unit up or down to your desired position until the parent unit gets a good reception of the baby.

NOTE

Do not place the camera within baby's reach!

3.3 Selecting camera channel

The Parent unit has 4 camera channels of which the video and audio feed from the channels can be displayed on the LCD. You will need additional cameras paired to the parent unit if you wish to monitor different areas using this channel option.

To switch between the channels, press .

3.4 Pairing camera channels

The enclosed camera has already been paired and no setup is required. For additional cameras, you will need to pair them to new channels before you can use them. There are up to 4 camera channels available for pairing. See "2.4 Registration" for more details.



3.5 Night vision

The camera has 9 high-intensity infrared LEDs for picking up clear images in the dark. When the built-in photo sensor detects a low level of ambient light, the LEDs will automatically activate and the screen on the parent unit will display in black and white.

3.6 Talk function

Press and hold **▲** on the parent unit to talk to your baby through the baby unit loudspeaker. The symbol  will be displayed at the top of the LCD screen.



3.7 Adjusting the volume of the parent unit

When the video is playing or in standby mode, press **◀** to decrease volume or **▶** to increase volume.

4. MBP30 Parent Unit Menu Options



4.1 Brightness

This option lets you change the brightness of the LCD.

1. Press  to enter menu mode.
2. Press **▲** or **▼** until  is selected on the LCD screen.
3. Press **◀** or **▶** to adjust the LCD brightness level.
The LCD brightness will be adjusted accordingly.

4.2 Night Vision

When activated, this function automatically switches the camera to night vision when the brightness level of the room where the camera is placed is not strong enough.



1. Press  to enter menu mode.
2. Press **▲** or **▼** until  is selected on the LCD screen.



3. Press ◀ or ▶ to turn the Baby Unit Night Vision On or Off. The night lights on the baby unit will be switched on and off accordingly.

4.3 Voice Activation

The sound detection sensitivity level (VOX) of the Baby Monitor can be adjusted. If the baby is a quiet sleeper, the sensitivity level can be increased so that minor disturbances can be detected and transmitted to the parent unit.

1. Press  to enter menu mode.
2. Press ▲ or ▼ until  is selected on the LCD screen.
3. Press ◀ or ▶ to adjust the VOX level.



When the VOX function is on, VOX will be displayed at the top of the LCD screen. The LCD screen will switch off after a few seconds if the detected sound is below the level selected.

NOTE

The LCD screen on the parent unit will be switched back on when the sound level of the baby reaches the VOX threshold or when any key on the parent unit is pressed.

4.4 Video Timer

This function makes the LCD switch off automatically after a certain amount of time (1 min) in order to save power, unless it is set to always on.

1. Press  to enter menu mode.
2. Press ▲ or ▼ until  is selected on the LCD screen.
3. Press ◀ or ▶ to turn the Parent Unit Video Timer On or Off (the default setting is On).

NOTE

The LCD turns on automatically when the sound level reaches the VOX threshold or when any key on the parent unit is pressed. This setting applies to all cameras paired to the parent unit.



5. Disposal of the device (environment)

At the end of the product lifecycle, you should not dispose of this product with normal household waste, but take the product to a collection point for the recycling of electrical and electronic equipment. The symbol on the product, user's guide and/or box indicates this.



Some of the product materials can be re-used if you take them to a recycling point. By reusing some parts or raw materials from used products you make an important contribution to the protection of the environment.

Please contact your local authorities in case you need more information on the collection points in your area.

Dispose of the battery pack in an environmentally-friendly manner according to your local regulations.

6. Cleaning

Clean the MBP30 with a slightly damp cloth or with an anti-static cloth. Never use cleaning agents or abrasive solvents.

Cleaning and care

- Do not clean any part of the product with thinners or other solvents and chemicals — this may cause permanent damage to the product which is not covered by the Warranty. When necessary, clean it with a damp cloth.
- Keep your MBP30 away from hot, humid areas or strong sunlight, and don't let it get wet.
- Every effort has been made to ensure high standards of reliability for your MBP30. However, if something does go wrong, please do not try to repair it yourself — contact Customer Service for assistance.



7. Help

Display

No display

- Try recharging or replacing the battery pack.
- Reset the units. Disconnect the battery pack of the parent unit and unplug the units' electrical power, then plug them back in.
- Is the unit turned on?
Press and release  on the parent unit to turn it on.

Registration

If the baby unit has lost its link with the parent unit

- Try recharging or replacing the battery pack.
- If the baby unit is too far away it may be going out of range, so move the baby unit closer to the parent unit.
- Reset the units by unplugging the units' electrical power. Wait for around 15 seconds and plug it back in again. Allow up to one minute for the baby unit and the parent unit to synchronize.
- See "2.4 Registration" if there is a need to re-register the units.

8. General Information

If your product is not working properly....

1. Read this User's Guide or the Quick Start Guide.
2. Visit our website:
<http://www.motorola.com>
3. Contact Customer Service at US 1-888-331-3383 or
Canada 905-831-6555.

To order a replacement battery pack, contact customer service or visit our website.



Consumer Products and Accessories purchased in the United States or Canada

What Does this Warranty Cover?

Subject to the exclusions and limitations contained below, Binatone Electronics International LTD. warrants the Motorola branded consumer products that it manufactures (“Products”) and the Motorola branded or certified accessories sold for use with these Products that it manufactures (“Accessories”) to be free from defects in materials and workmanship under normal consumer usage for the period(s) outlined below. This limited warranty is a consumer’s exclusive remedy, and only applies as follows to new Motorola branded Products and Accessories manufactured by Binatone Electronics International LTD., and purchased by consumers in the United States or Canada, which are accompanied by this written warranty:

Who is covered?

This warranty covers only the first consumer purchaser, and is not transferable.

What will BINATONE ELECTRONICS INTERNATIONAL LTD. do?

BINATONE ELECTRONICS INTERNATIONAL LTD., at its sole option, will at no charge repair, replace or refund the purchase price of any Products or Accessories that does not conform to this warranty. Binatone Electronics International LTD. may use functionally equivalent reconditioned/ refurbished/ pre-owned or new Products, Accessories or parts in such repair or replacement and any Products, Accessories or parts removed or being replaced under this warranty become the property of Binatone Electronics International LTD.

What Other Limitations Are There?

ANY IMPLIED WARRANTIES OR CONDITIONS IRRESPECTIVE OF WHETHER THEY ARE IMPOSED BY LAW OR OTHERWISE, INCLUDING WITHOUT LIMITATION THE IMPLIED WARRANTIES OF MERCHANTABILITY AND FITNESS FOR A PARTICULAR PURPOSE, SHALL BE LIMITED TO THE DURATION OF THIS



LIMITED WARRANTY, OTHERWISE THE REPAIR, REPLACEMENT, OR REFUND AS PROVIDED UNDER THIS EXPRESS LIMITED WARRANTY IS THE EXCLUSIVE REMEDY OF THE CONSUMER, AND IS PROVIDED IN LIEU OF ALL WARRANTIES AND MOTOROLA AND BINATONE ELECTRONICS INTERNATIONAL LTD. MAKES NO OTHER WARRANTIES OR CONDITIONS, EXPRESS OF IMPLIED. IN NO EVENT SHALL MOTOROLA OR BINATONE ELECTRONICS INTERNATIONAL LTD. BE LIABLE, WHETHER UNDER THIS LIMITED WARRANTY OR IN CONTRACT OR TORT (INCLUDING NEGLIGENCE OR STRICT PRODUCT LIABILITY) OR OTHERWISE FOR DAMAGES OR CLAIMS IN EXCESS OF THE PURCHASE PRICE OF THE PRODUCT OR ACCESSORY, OR FOR ANY INDIRECT, INCIDENTAL, SPECIAL OR CONSEQUENTIAL DAMAGES OF ANY KIND, OR LOSS OF REVENUE, SAVINGS OR PROFITS, LOSS OF BUSINESS, LOSS OF PROGRAMS DATA INFORMATION (WHETHER CONFIDENTIAL PROPRIETARY OR PERSONAL IN NATURE OR OTHERWISE) OR OTHER FINANCIAL LOSS ARISING OUT OF OR IN CONNECTION WITH THE ABILITY OR INABILITY TO USE THE PRODUCTS OR ACCESSORIES AND BINATONE ELECTRONICS INTERNATIONAL LTD. SHALL UNDER NO CIRCUMSTANCES BE LIABLE FOR ANY CLAIMS OR DEMANDS MADE BY ANY THIRD PARTY OR MADE BY YOU ON BEHALF OF ANY THIRD PARTY TO THE FULL EXTENT THESE DAMAGES OR CLAIMS MAY BE DISCLAIMED BY LAW.

Some states, countries or jurisdictions do not allow the limitation or exclusion of incidental or consequential damages, or limitation on the length of an implied warranty, so the above limitations or exclusions may not apply to you in such states, countries or jurisdictions. This warranty gives you specific legal rights, and you may also have other rights that vary from state to state or from one country/jurisdiction to another.

Products or Accessories Covered	Length of Coverage
Consumer Products	One (1) year from the date of purchase by the first consumer purchaser of the product.



Consumer Accessories	Ninety (90) days from the date of purchase by the first consumer purchaser of the accessory.
Consumer Products and Accessories that are Repaired or Replaced	The balance of the original warranty or for ninety (90) days from the date returned to the consumer, whichever is longer.

Exclusions

Normal Wear and Tear. Periodic maintenance, repair and replacement of parts due to normal wear and tear are excluded from coverage.

Batteries. Only batteries whose fully charged capacity falls below 80% of their rated capacity and batteries that leak are covered by this limited warranty. Battery life and the changes in battery capacity with time or use are excluded from this warranty.

Abuse & Misuse. Defects or damage that result from: (a) improper or unreasonable use, operation, storage, misuse or abuse, accident or neglect or other external cause, such as physical damage (cracks, scratches, etc.) to the surface of the product resulting from misuse; (b) your failure to follow or operate outside the usage parameters stated in the user instructions that came with the Products or Accessories; (c) contact with liquid, water, rain, extreme humidity or heavy perspiration, sand, dirt or the like, extreme heat, or food; (d) use of the Products or Accessories for commercial purposes or subjecting the Product or Accessory to abnormal usage or conditions; or (e) other acts or omissions which are not the fault or neglect of Motorola or Binatone Electronics International LTD., are excluded from coverage.

Use of Non-Motorola branded Products and Accessories. Defects or damage that result from the use of Non-Motorola branded or certified Products or Accessories or other peripheral equipment are excluded from coverage.

Unauthorized Service or Modification. Defects or damages resulting from service, testing, adjustment, installation, maintenance, alteration, or modification in any way by someone other than Motorola, Binatone Electronics International LTD. or its authorized service centers, are excluded from coverage.



Altered Products. Products or Accessories with (a) serial numbers or date tags that have been removed, altered or obliterated; (b) broken seals or that show evidence of tampering; (c) mismatched board serial numbers; or (d) nonconforming or non-Motorola branded housings, or parts, are excluded from coverage.

Communication Services. Defects, damages, or the failure of Products or Accessories due to any communication service or signal you may subscribe to or use with the Products or Accessories is excluded from coverage.

How to Obtain Warranty Service or Other Information?

To obtain service or information, please call:

US: 1-888-331-3383

CANADA: 905-831-6555

You will receive instructions on how to ship the Products or Accessories, the shipment of which shall be at your own risk and expense, to a BINATONE ELECTRONICS INTERNATIONAL LTD. Authorized Repair Center. To obtain service, you must include: (a) a copy of your receipt, bill of sale or other comparable proof of purchase of the Products or Accessories showing the date of purchase; (b) a written description of the problem; and, most importantly; (c) your address and telephone number.

These terms and conditions constitute the complete warranty agreement between you and BINATONE ELECTRONICS INTERNATIONAL LTD. regarding the Products or Accessories purchased by you, and supersede any prior agreement or representations, including representations made in any literature publications or promotional materials issued by BINATONE ELECTRONICS INTERNATIONAL LTD. or representations made by any agent employee or staff of BINATONE ELECTRONICS INTERNATIONAL LTD., that may have been made in connection with the said purchase.



FCC and IC regulations

FCC Part 15

NOTE: This equipment has been tested and found to comply with the limits for a Class B digital device, pursuant to Part 15 of the Federal Communications Commission (FCC) rules. These limits are designed to provide reasonable protection against harmful interference in a residential installation. This equipment generates, uses and can radiate radio frequency energy and, if not installed and used in accordance with the instructions, may cause harmful interference to radio communications. However, there is no guarantee that interference will not occur in a particular installation. If this equipment does cause harmful interference to radio or television reception, which can be determined by turning the equipment off and on, the user is encouraged to try to correct the interference by one or more of the following measures:

- Reorient or relocate the receiving antenna.
- Increase the separation between the equipment and receiver.
- Connect the equipment into an outlet on a circuit different from that to which the receiver is connected.
- Consult the dealer or an experienced radio/TV technician for help.

Changes or modifications to this equipment not expressly approved by the party responsible for compliance could void the user's authority to operate the equipment.

This device complies with Part 15 of the FCC rules. Operation is subject to the following two conditions: (1) this device may not cause harmful interference, and (2) this device must accept any interference received, including interference that may cause undesired operation. Privacy of communications may not be ensured when using this device.

To ensure safety of users, the FCC has established criteria for the amount of radio frequency energy that can be safely absorbed by a user or bystander according to the intended usage of the product. This product has been tested and found to comply with the FCC criteria. The Baby unit shall be installed and used such that parts of the user's body other than the hands are maintained at a distance of approximately 20 cm (8 inches) or more.

This Class B digital apparatus complies with Canadian ICES-003.



WARNING

Changes or modifications to this equipment not expressly approved by the party responsible for compliance could void the user's authority to operate the equipment.

Industry Canada

Operation is subject to the following two conditions: (1) this device may not cause harmful interference, and (2) this device must accept any interference, including interference that may cause undesired operation of the device.

The term "IC: " before the certification/registration number only signifies that the Industry Canada technical specifications were met.

This product meets the applicable Industry Canada technical specifications.

RENSEIGNEMENTS RELATIFS AUX RÈGLEMENTS DE LA COMMISSION FÉDÉRALE DES COMMUNICATIONS 'FCC', ET D'INDUSTRIE Canada 'IC'

Article 15 des règlements du FCC

AVIS: Cet équipement a été testé et s'est révélé conforme aux limites d'un appareil numérique de classe B, conformément à la Section 15 du règlement de la Federal Communications Commission (FCC). Ces limites sont conçues pour offrir une protection raisonnable contre toute interférence nuisible sur une installation résidentielle. Cet appareil génère, utilise et peut émettre des fréquences radio et s'il n'est pas installé selon les instructions, peut nuire aux radiocommunications. Toutefois, rien ne garantit que des parasites ne surviendront pas dans une installation particulière. Si cet appareil cause des interférences nuisibles à la réception du téléviseur ou de la radio, ce que vous pouvez déterminer en mettant votre appareil en et hors fonction, nous vous invitons à essayer l'une des mesures correctives suivantes :

- Réorientez l'antenne de réception.
- Éloignez l'appareil du composant qui reçoit les ondes.
- Branchez l'appareil dans une prise de courant CA différente de celle du composant qui reçoit les ondes.
- Au besoin, consultez votre marchand électronique ou un technicien spécialisé dans le service des radios/téléviseurs pour des suggestions supplémentaires.



Toute modification ou changement effectué à cet appareil sans l'accord des parties responsables de l'homologation peut retirer à l'utilisateur son droit d'utiliser l'appareil.

Cet appareil est conforme à l'article 15 de la FCC. Le fonctionnement est soumis aux deux conditions suivantes: (1) Cet appareil ne doit pas causer d'interférences nuisibles et; (2) Il doit pouvoir supporter les parasites qu'il reçoit, incluant les parasites pouvant nuire à son fonctionnement. La confidentialité des communications peut ne pas être assurée avec cet appareil.

Afin de garantir la sécurité des utilisateurs, la FCC a établi les critères relatifs à l'énergie générée par les fréquences radio pouvant être absorbée en toute sécurité par un utilisateur ou par quelqu'un se trouvant à proximité, dépendamment de l'utilisation prévue du produit. Ce produit a été testé et s'avère conforme aux normes de la FCC. L'unité du bébé devra être installée et utilisée de manière à ce que le corps de l'utilisateur, à l'exception des mains, soit toujours à une distance d'environ 20 cm (8 po.) ou plus.

Cet appareil numérique de la classe B est conforme à la norme NMB-003 du Canada.

AVERTISSEMENT

Tout changement ou modification à cet équipement, non expressément autorisé par la partie responsable de la conformité, pourrait annuler l'autorisation donnée à l'utilisateur d'utiliser cet équipement.

Industrie Canada

Le fonctionnement est soumis aux deux conditions suivantes : (1) Cet appareil ne doit pas causer d'interférences nuisibles et; (2) Cet appareil accepte toute les interférences dont celles qui pourraient provoquer le fonctionnement involontaire de l'appareil.

L'abréviation 'IC' se trouvant avant cette homologation signifie que la certification fut effectuée selon une déclaration de conformité spécifiant que les normes d'Industrie Canada ont été rencontrées.

Cet appareil est conforme aux spécifications techniques d'Industrie Canada.



Technical Specifications

Baby unit

Frequency	2.4GHz to 2.4835GHz
Maximum range	Extended range up to 450 feet* *Based on unobstructed line of sight. Actual range will vary depending on surroundings.
Image sensor	Colour CMOS
Lens	f 2.5mm, F 2.8
IR LED	9 pcs
Power	DC 5V, 500mA (Model: Kings, KSS05-050-0500U)

Parent unit

Frequency	2.4GHz to 2.4835GHz
Display	2.4" TFT LCD
Desplay colours	16.7M colour LCD
Brightness control	5 steps
Power	Adaptor: DC 5V, 1000mA (Model: Kings, KSS05-050-1000U) OR Battery: NiMH rechargeable battery pack (Model: TFL3X44AAA650-CD77-01B)

WARNING
Do not use non-rechargeable batteries for the Parent Unit. Risk of explosion if battery is replaced by an incorrect type. Dispose of used batteries according to the instructions.



9. Wall mounting instructions

1. Cut the illustration below and drill holes in the wall exactly as illustrated.

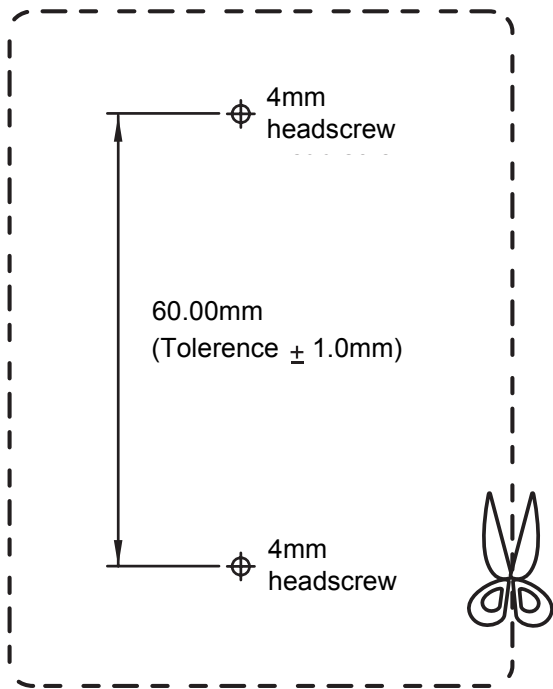



2. Insert 4mm head screws (to be purchased separately) into the holes and tighten the screws. Then, align your camera with the screws and push it down.

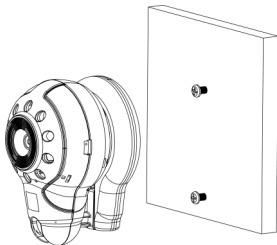

3. Point the lens of the camera towards the area you want to monitor. Tilt the head of the baby unit up or down to your desired position until the parent unit gets a good reception of the baby.

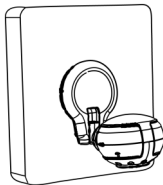
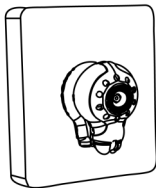
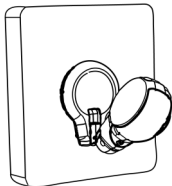



MOTOROLA

Manufactured, distributed or sold by Binatone Electronics International LTD., official licensee for this product. MOTOROLA and the Stylized M Logo, and other Motorola trademarks and trade dress are owned by Motorola, Inc. and are used under license from Motorola, Inc. MOTOROLA and the Stylized M Logo are registered in the US Patent & Trademark Office. All other product or service names are the property of their respective owners.

© Motorola, Inc. 2009. All rights reserved.



Version 1.0

Printed in China

