

Doc Title :	Product Data – User’s Guide	Revision :	R.00
Model :	MBP482	Page(s) :	1 of 17



motorola

User’s Guide

Video Baby Monitor

MBP482PU; MBP482BU

Doc Title :	Product Data – User’s Guide	Revision :	R.00
Model :	MBP482	Page(s) :	2 of 17

Welcome...

to your new Motorola Baby monitor!

Thank you for purchasing the MBP482. Now you can see and hear your baby sleeping in another room or you can monitor your older children in their play room.

Please retain your original dated sales receipt for your records. For warranty service of your Motorola product, you will need to provide a copy of your dated sales receipt to confirm warranty status. Registration is not required for warranty coverage.

For product-related questions, please call:

US and Canada 1-888-331-3383
Email: motorola@encompass.com

This User’s Guide provides you with all the information you need to get the most from your product.

Before you use the baby monitor, we recommend you insert and fully charge the battery in the parent unit, so that it continues to work if you disconnect it from the mains power to carry it to another location. Please read the Safety Instructions on page 8 before you install the units.

Got everything?

- 1 x Parent unit
- 1 x Baby unit (baby unit)
- 1 x Rechargeable Ni-MH battery pack for the Parent unit
- 1 x Battery door for Parent unit
- 1 x Stand for Parent unit
- 1 x Power adaptor for the Parent unit
- 1 x Power adaptor for the Baby unit

In multi-baby unit packs, you will find one or more additional Baby unit units with power adaptor units.

Overview of your Baby unit

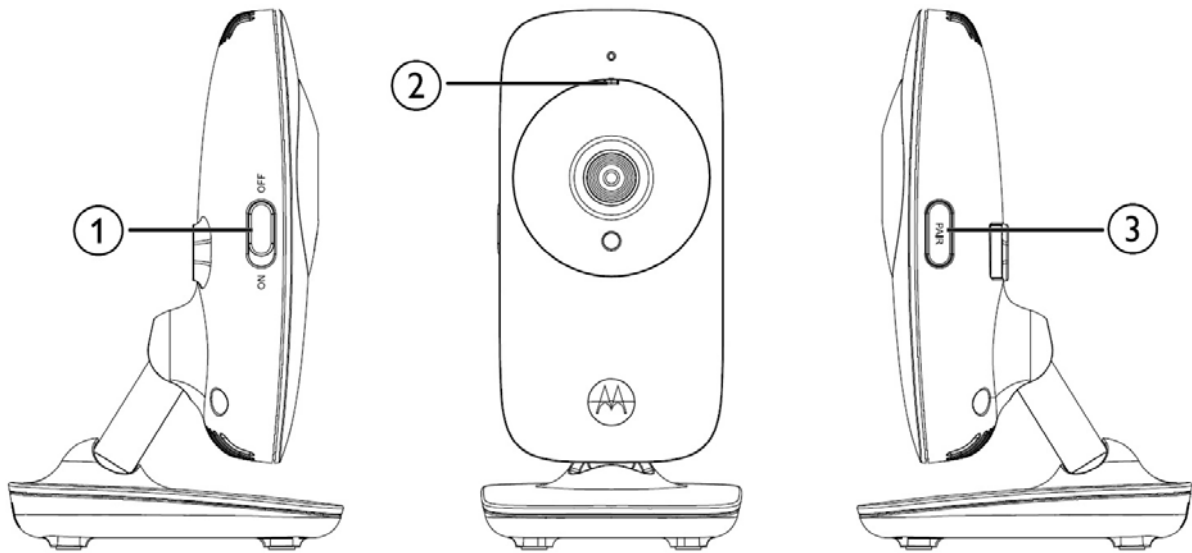

1 Power ON/OFF switch

Slide to turn the parent unit on or off.

2 Power/Link indicator

- Red when the baby unit is turned on and linked to the parent unit.
- Flashes red when the baby unit is searching for the parent unit, or is in pairing process.
- Off when the baby unit is powered off.

3 PAIR

Press and hold to pair to the parent unit.

Overview of the Parent unit

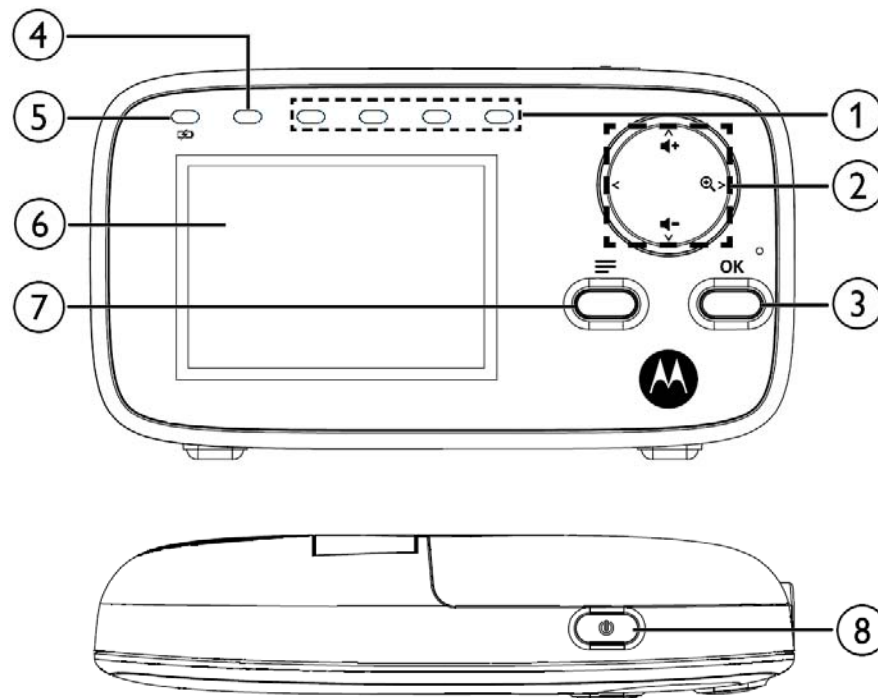

1. Sound Level indicators

The sound level indicators show the sound level as detected by the baby unit.

- Sound level detected by the baby unit:

The more LEDs light on, the stronger the sound is detected.

2 Control key panel

UP / VOLUME +

- Press to increase the speaker volume.
- While in the menu, press to scroll up.
- While viewing a zoomed image, press and hold to move the image upward.

DOWN / VOLUME -

- Press to decrease the speaker volume.
- While in the menu, press to scroll down.
- While viewing a zoomed image, press and hold to move the image downward.

LEFT <

- While viewing a zoomed image, press and hold to move the image leftward.

ZOOM / RIGHT

- While in a menu, press to choose the option on the right side.
- While viewing a zoomed image, press to zoom out; or press and hold to move the image rightward..

3. OK

While in a menu, press to choose an item, or save a setting.

Doc Title :	Product Data – User’s Guide	Revision :	R.00
Model :	MBP482	Page(s) :	5 of 17

4 Power ON/OFF indicator

- Red when the parent unit is turned on.
- Flashes red when the parent unit is searching for the parent unit, or is in pairing process..
- Off when the parent unit battery is fully charge

5 Battery level indicator

- Green when the parent unit battery is being charged.
- Flashes green when the parent unit battery is low and needs charging.
- Off when the parent unit battery is not being charged, or when no battery is installed.

6 LCD display



















7.

Press to enter the main menu.

8 Power ON/OFF button

- Press and hold the parent unit on or off.
- Press to turn the screen on or off.

Parent unit Status Icons

	<p>Connection status</p> <ul style="list-style-type: none"> -  displays when strong signal strength is detected between the baby unit and the parent unit. -  or  displays when moderate signal strength is detected between the baby unit and the parent unit. -  flashes when the parent unit is out of the valid range. -  displays when the link between the baby unit and the parent unit is lost.
	<p>Patrol mode</p> <ul style="list-style-type: none"> - Displays when the parent unit is in patrolling mode.
	<p>Current view status</p> <ul style="list-style-type: none"> - Displays the number of the baby unit that is being viewed in patrol mode.
	<p>Zoom</p> <ul style="list-style-type: none"> - Displays when the microphone is muted.
	<p>Volume off</p> <ul style="list-style-type: none"> - Displays when the volume is turned off.
<p>20°C or 69°F</p>	<p>Temperature</p> <ul style="list-style-type: none"> - Displays the current temperature the baby unit has detected.
	<p>Battery status</p> <ul style="list-style-type: none"> -  ->  ->  ->  animates when the battery is charging. -  displays solid when the battery is fully charged. -  displays when the battery is low and needs charging. -  displays when no battery is installed but operates using AC power, or the battery has been installed incorrectly.

Important guidelines for installing your baby monitor

- To use your baby unit and parent unit together, you must be able to establish a radio link between them, and the range will be affected by environmental conditions.
- Any large metal object, like a refrigerator, a mirror, a filing cabinet, a metallic door or reinforced concrete, between the baby unit and parent unit may block the radio signal.
- The signal strength may also be reduced by other solid structures, like walls, or by radio or electrical equipment, such as TVs, computers, cordless or mobile phones, fluorescent lights or dimmer switches.
- If the signal is poor, try moving the parent unit and/or the baby unit to different positions in the rooms.

TABLE OF CONTENTS

1	SAFETY INSTRUCTIONS	8
2	GETTING STARTED	9
2.1	CONNECTING BABY UNIT TO POWER.....	9
2.2	INSTALLING BATTERY AND CONNECTING PARENT UNIT TO POWER	10
2.3	THE STAND ON THE PARENT UNIT.....	11
3	USING YOUR BABY MONITOR	11
3.1	POWER ON OR OFF THE BABY UNIT	11
3.2	POWER ON OR OFF THE PARENT UNIT	11
3.3	TURN OFF THE PARENT UNIT SCREEN.....	11
3.4	ADJUST THE SPEAKER VOLUME FOR PARENT UNIT	11
3.5	ADJUST THE LCD BRIGHTNESS OF THE PARENT UNIT	12
3.6	SET THE ALARM ON THE PARENT UNIT	12
3.7	MONITOR THE TEMPERATURE.....	12
3.7.1	<i>Temperature format</i>	12
3.8	DELETE A BABY UNIT	12
3.9	SET THE SCREEN OFF TIME OF THE PARENT UNIT	12
3.10	ZOOM	13
3.11	PAIR AND REPLACE EXTRA NEW BABY UNIT	13
4	DISPOSAL OF THE DEVICE (ENVIRONMENT)	13
5	CLEANING	13
6	TROUBLESHOOTING	14
7	GENERAL INFORMATION	14
8	TECHNICAL SPECIFICATIONS	17

Doc Title : Product Data – User’s Guide	Revision : R.00
Model : MBP482	Page(s) : 8 of 17

1 SAFETY INSTRUCTIONS



WARNING:

STRANGULATION HAZARD – Keep the unit and adaptor cord more than 3 feet from the crib and out of the baby’s reach.

NEVER place baby unit or cords within the crib.

Secure the cords more than 3 feet away from the baby’s reach.

Never use extension cords with AC Adaptors. Only use the AC Adaptors provided.

BABY UNIT SET UP & USE:

- Determine a location for the BABY UNIT that will provide the best view of your baby in his/her crib.
- Place the BABY UNIT on a flat surface, such as a dresser, bureau, or shelf or mount the Unit to a wall securely using the keyhole slots under the stand.
- NEVER place the Baby unit or cords within the crib.

WARNING

This Baby Monitor is compliant with all relevant standards regarding electromagnetic fields and is, when handled as described in the User’s Guide, safe to use. Therefore, always read the instructions in this User’s Guide carefully before using the device.

- Adult assembly is required. Keep small parts away from children when assembling.
- This product is not a toy. Do not allow children to play with it.
- This Baby Monitor is not a substitute for responsible adult supervision.
- Keep this user’s guide for future reference.
- Keep the cords out of reach of children.
- Do not cover the Baby Monitor with a towel or blanket.
- Test this monitor and all its functions so that you are familiar with it prior to actual use.
- Do not use the Baby Monitor in damp areas or close to water.
- Do not install the Baby Monitor in extreme cold or heat, direct sunlight, or close to a heat source.
- Only use the chargers and power adaptors provided. Do not use other chargers or power adaptors as this may damage the device and battery pack.
- Only insert a battery pack of the same type.
- Do not touch the plug contacts with sharp or metal objects.
- Connect the power adaptors to easily accessible electrical outlets.

CAUTION

You chance the risk of explosion if battery is replaced by an incorrect type.

Dispose of used batteries according to their instructions.

se only the rechargeable battery pack with rating: 3.6V 800mAh

2 GETTING STARTED

2.1 Connecting baby unit to power

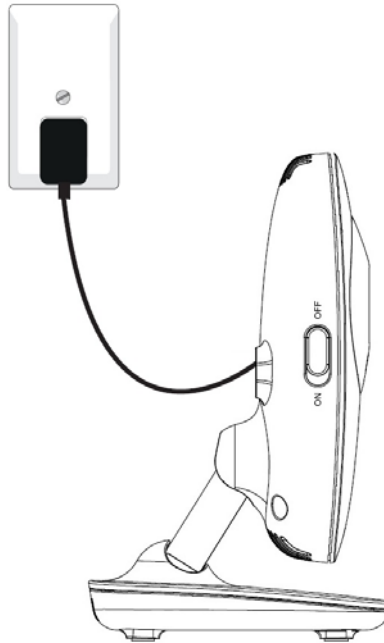

1. Insert the DC plug of the power adaptor with the smaller DC plug into the DC jack in the side of the baby unit.
2. Connect the other end of the power adaptor to a suitable power outlet.

NOTE

Only use the provided power adaptor.

2.2 Installing battery and connecting parent unit to power

A rechargeable battery pack is supplied and should be fitted, so that the parent unit can be moved without losing the link and picture from the baby unit(s). Charge the parent unit before you use it for the first time or when the parent unit indicates that the battery is low

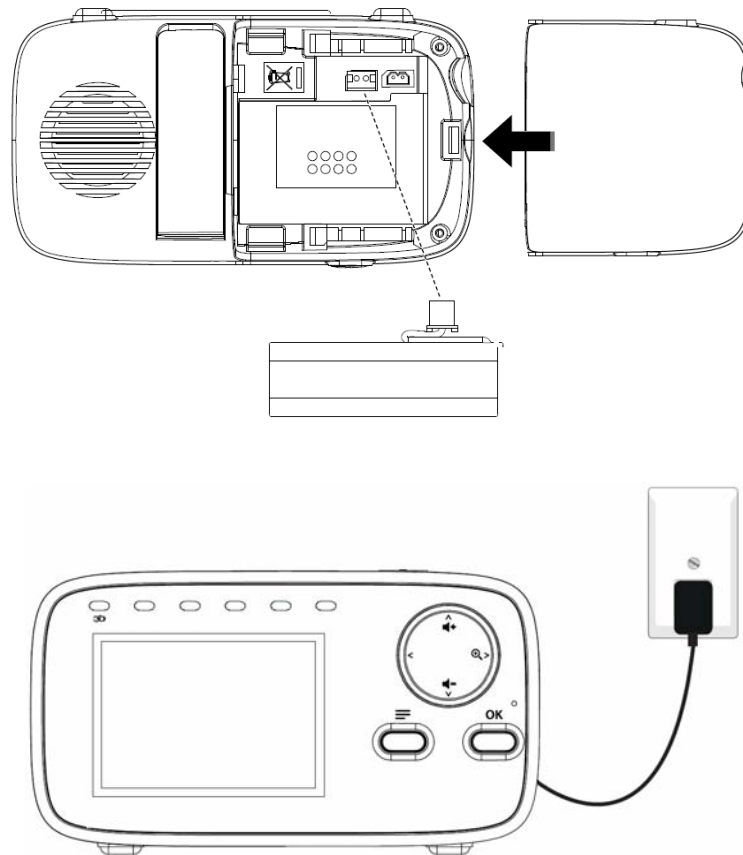

1. Slide off the battery compartment cover
2. Insert the plug of the battery pack into the jack inside the battery compartment, and fit the battery pack into the compartment.
3. Replace the battery compartment cover, and pull out the stand (refer to section 2.3).
4. Insert the DC plug of the power adaptor with the bigger DC plug into the DC jack in the side of the parent unit.
5. Connect the other end of the power adaptor to a suitable power outlet.
6. The battery level indicator turns comes on

NOTE

Only use the provided power adaptor and battery pack. The parent unit can work with the power adaptor connected but without a battery pack installed.

Doc Title :	Product Data – User’s Guide	Revision :	R.00
Model :	MBP482	Page(s) :	11 of 17

2.3 The stand on the parent unit

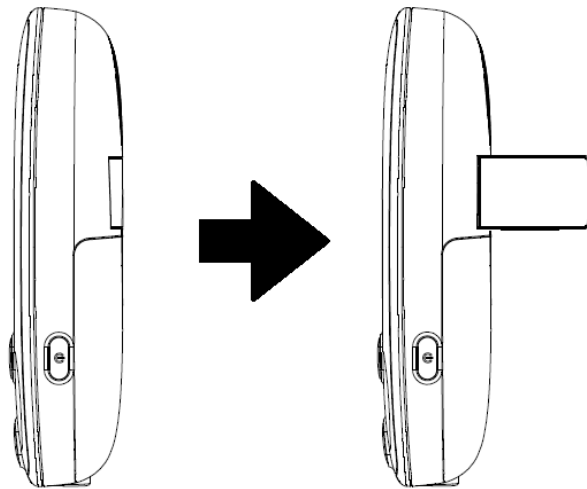



- Pull the stand out so that parent unit can stand.



3 USING YOUR BABY MONITOR

Please read these instructions carefully, and be aware that this baby monitor is only intended as an aid. It is not a substitute for responsible, correct parental supervision.

3.1 Power on or off the baby unit

- Press and hold  to turn on the baby unit. The **Power/Link indicator** turns on.
- Press and hold  again to turn off the baby unit. The **Power/Link indicator** light turns off.

3.2 Power on or off the parent unit

- Press and hold  to turn on the parent unit. The **Power indicator** turns on.
- Press and hold  again to turn off the parent unit. The **Power indicator** turns off.

NOTE

If you place the parent and baby units too close together, you may hear a high pitched noise. This is not a fault. The units are designed to be operated at some distance apart, e.g. in separate rooms, so move the units further apart.

3.3 Turn off the parent unit screen

You can turn on or off the parent unit screen without powering off the parent unit. You can still hear sound from the baby unit.

- Press and hold  on the parent unit to turn off the screen..
- Press any key on the parent unit to turn on the screen again.

3.4 Adjust the speaker volume for parent unit

You can adjust the speaker volume from **Volume 1** to **Volume 5**, or turn it off.





- Press  or  on the parent unit when it is not in use.

When the speaker volume is set to off, the screen displays .

Doc Title :	Product Data – User’s Guide	Revision :	R.00
Model :	MBP482	Page(s) :	12 of 17

3.5 Adjust the LCD brightness of the parent unit













You can adjust the brightness of the parent unit screen from **Level 1** to **Level 5**.

1. Press  when the parent unit is not in use.  is displayed.
2. Press  or  to adjust the brightness.
3. Press **OK** to confirm your selection.







3.6 Set the alarm on the parent unit

You can use the parent unit to set the alarm as a reminder for you to take care of your baby.

Turn on and set the alarm when it is currently off:

1. Press  when the parent unit is not in use.
2. Press  or  to scroll to .
3. Press  or  to choose **On**, then press **OK**.
4. Press  and then press  or  to scroll to  again.
5. Press  or  to choose **2h, 3h, 4h, 5h** or **6h**
6. Press **OK** to confirm your selection.

Turn off the alarm when it is currently on:







1. Press  when the parent unit is not in use.
2. Press  or  to scroll to .
3. Press  or  to choose **Off**
4. Press **OK** to confirm your selection.

3.7 Monitor the temperature

Your baby unit measures the surrounding temperature. If the detected temperature falls beyond a desired temperature range, you will hear an alert tone. You can change the settings for the temperature format as follows.









3.7.1 Temperature format

You can choose to display the temperature in °F or °C.

1. Press  when the parent unit is not in use.
2. Press  or  to scroll to .
3. Press  or  to choose **°F** or **°C**.
4. Press **OK** to confirm your selection.







3.8 Delete a baby unit

You can choose to remove a paired baby unit from the parent unit.

1. Press  when the parent unit is not in use.
2. Press  or  scroll to .
3. Press  or  to select the desired baby unit (**1, 2, 3** or **4**).
4. Press  or  to choose **YES** or **NO**
5. Press **OK** to confirm your selection.

3.9 Set the screen off time of the parent unit

You can set the screen of time the parent unit after being in the idle mode for a particular time interval.

1. Press  when the parent unit is not in use.
2. Press  or  to scroll to .
3. Press  or  select (**60m, 30m, 5m** or **OFF**).
4. Press **OK** to confirm your selection.

Doc Title :	Product Data – User’s Guide	Revision :	R.00
Model :	MBP482	Page(s) :	13 of 17

3.10 Zoom

You can zoom in or out while viewing image from baby unit.

1. Press to zoom in.
2. Press and hold , , or to move the zoomed image upward, downward, leftward or rightward correspondingly.
3. Press to zoom out.

3.11 Pair and replace extra new baby unit

The baby units and parent unit provided are already paired. You can add or replace baby unit in your video and audio monitor system.

You can pair a maximum of four baby units to your parent unit. Each new baby unit must be paired to the parent unit before use.

To pair and replace a baby unit:

1. Press when the parent unit is not in use.
2. Press or to scroll to .
2. Press or to choose a desired baby unit slot, then press **OK**. The pairing mode starts.

NOTE

If you choose an occupied baby unit slot, the new baby unit will replace the existing baby unit.

4. Turn on the new baby unit, and then immediately press and hold **Pair** until the Power/Link indicator turns on.

4 DISPOSAL OF THE DEVICE (ENVIRONMENT)

At the end of the product lifecycle, you should not dispose of this product with normal household waste. Take this product to a collection point for the recycling of electrical and electronic equipment. The symbol on the product, user’s guide and/or box indicates this.



Some of the product materials can be re-used if you take them to a recycling point. By reusing some parts or raw materials from used products you make an important contribution to the protection of the environment.

Please contact your local authorities in case you need more information on the collection points in your area.

Dispose of the battery pack in an environmentally-friendly manner according to your local regulations.

5 CLEANING

Clean your MBP482 with a slightly damp cloth or with an anti-static cloth. Never use cleaning agents or abrasive solvents.

Cleaning and care

- Do not clean any part of the MBP482 with thinners or other solvents and chemicals – this may cause permanent damage to the product which is not covered by the warranty.
- Keep your MBP482 away from hot, humid areas or strong sunlight, and do not let it get wet.
- Every effort has been made to ensure high standards of reliability for your MBP482. However, if something does go wrong, please do not try to repair it yourself – contact Customer Service for assistance.

IMPORTANT

Always switch off and disconnect the power adaptor before cleaning your baby monitor.

Doc Title :	Product Data – User’s Guide	Revision :	R.00
Model :	MBP482	Page(s) :	14 of 17

6 TROUBLESHOOTING

Power Indicator on the parent unit does not come on

- Check whether the parent unit is powered on.
- Check whether the supplied battery pack is correctly installed and that they are not drained.
- Recharge the parent unit by connecting it to the power supply.

Power/Link Indicator on the baby unit flashes

- The baby unit may be not paired to the parent unit. Refer to section 3.11 to pair the baby unit.
- The parent unit and the baby unit may be out of range with each other. Reduce the distance between the units, but not closer than 3 feet.
- The baby unit may be switched off. Press the  button to switch on the baby unit.

light on the parent unit flashes

- Battery pack in the parent unit is running low. Connect the parent unit to the mains power with the supplied power adaptor for recharging.

The parent unit beeps

- The parent unit may have lost connection with the monitoring baby unit. Reduce the distance between the parent unit and the baby unit, but not closer than 3 feet.
- The baby unit may be switched off. Press the  button to switch on the baby unit.
- Battery pack in parent unit is running low. Connect the parent unit to the mains power with the supplied power adaptor for recharging.

Cannot hear sound or baby cry from the parent unit

- The volume level in the parent unit may be set too low, increase the volume level of the parent unit. Refer to section 3.4 for volume level settings
- The parent unit and the monitoring baby unit may be out of range with each other. Reduce the distance between the units, but not closer than 3 feet.

The baby monitor system produces a high-pitched noise

- The parent unit and the baby unit are too close to each other. Make sure the parent unit and baby unit is at least 3 feet away from each other.
- The speaker volume of the parent unit maybe set too high. Decrease the volume of the parent unit.

Battery pack in the parent unit is running low quickly

- The LCD brightness may be set too high. Try to decrease the brightness level. Refer to section 3.5 for details.
- The volume level of the parent unit may be set too high which consumes power. Decrease the volume level of the parent unit. Refer to section 3.4 for volume level settings.

7 GENERAL INFORMATION

If your product is not working properly...

1. Read this User’s Guide.
2. Visit our website: www.motorola.com
3. Contact Customer Service at
US and Canada 1-888-331-3383
Email: motorola@encompass.com

To order a replacement battery pack for parent unit, contact customer service.

Consumer Products and Accessories Limited Warranty (“Warranty”)

Thank you for purchasing this Motorola branded product manufactured under license by Binatone Electronics International LTD (“BINATONE”)

Doc Title :	Product Data – User’s Guide	Revision :	R.00
Model :	MBP482	Page(s) :	15 of 17

What Does this Warranty Cover?

Subject to the exclusions contained below, BINATONE warrants that this Motorola branded product ("Product") or certified accessory ("Accessory") sold for use with this product that it manufactured to be free from defects in materials and workmanship under normal consumer usage for the period outlined below. This Warranty is your exclusive warranty and is not transferable.

Who is covered?

This Warranty extends only to the first consumer purchaser, and is not transferable.

What will BINATONE do?

BINATONE or its authorized distributor at its option and within a commercially reasonable time, will at no charge repair or replace any Products or Accessories that does not conform to this Warranty. We may use functionally equivalent reconditioned/ refurbished/ pre-owned or new Products, Accessories or parts.

What Other Limitations Are There?

ANY IMPLIED WARRANTIES, INCLUDING WITHOUT LIMITATION THE IMPLIED WARRANTIES OF MERCHANTABILITY AND FITNESS FOR A PARTICULAR PURPOSE, SHALL BE LIMITED TO THE DURATION OF THIS LIMITED WARRANTY, OTHERWISE THE REPAIR OR REPLACEMENT PROVIDED UNDER THIS EXPRESS LIMITED WARRANTY IS THE EXCLUSIVE REMEDY OF THE CONSUMER, AND IS PROVIDED IN LIEU OF ALL OTHER WARRANTIES, EXPRESS OR IMPLIED. IN NO EVENT SHALL MOTOROLA OR BINATONE BE LIABLE, WHETHER IN CONTRACT OR TORT (INCLUDING NEGLIGENCE) FOR DAMAGES IN EXCESS OF THE PURCHASE PRICE OF THE PRODUCT OR ACCESSORY, OR FOR ANY INDIRECT, INCIDENTAL, SPECIAL OR CONSEQUENTIAL DAMAGES OF ANY KIND, OR LOSS OF REVENUE OR PROFITS, LOSS OF BUSINESS, LOSS OF INFORMATION OR OTHER FINANCIAL LOSS ARISING OUT OF OR IN CONNECTION WITH THE ABILITY OR INABILITY TO USE THE PRODUCTS OR ACCESSORIES TO THE FULL EXTENT THESE DAMAGES MAY BE DISCLAIMED BY LAW.

Some jurisdictions do not allow the limitation or exclusion of incidental or consequential damages, or limitation on the length of an implied warranty, so the above limitations or exclusions may not apply to you. This Warranty gives you specific legal rights, and you may also have other rights that vary from one jurisdiction to another.

Products Covered	Length of Coverage
Consumer Products	One (1) year from the date of the products original purchase by the first consumer purchaser of the product.
Consumer Accessories	Ninety (90) days from the date of the accessories original purchase by the first consumer purchaser of the product.
Consumer Products and Accessories that are Repaired or Replaced	The balance of the original warranty or for ninety (90) days from the date returned to the consumer, whichever is longer.

Exclusions

Normal Wear and Tear. Periodic maintenance, repair and replacement of parts due to normal wear and tear are excluded from coverage.

Batteries. Only batteries whose fully charged capacity falls below 80% of their rated capacity and batteries that leak are covered by this Warranty.

Abuse & Misuse. Defects or damage that result from: (a) improper operation, storage, misuse or abuse, accident or neglect, such as physical damage (cracks, scratches, etc.) to the surface of the product resulting from misuse; (b) contact with liquid, water, rain, extreme humidity or heavy perspiration, sand, dirt or the like, extreme heat, or food; (c) use of the Products or Accessories for commercial purposes or subjecting the Product or Accessory to abnormal usage or conditions; or (d) other acts which are not the fault of MOTOROLA or BINATONE., are excluded from coverage.

Use of Non-Motorola branded Products and Accessories. Defects or damage that result from the use of Non-Motorola branded or certified Products or Accessories or other peripheral equipment are excluded from coverage.

Doc Title :	Product Data – User’s Guide	Revision :	R.00
Model :	MBP482	Page(s) :	16 of 17

Unauthorized Service or Modification. Defects or damages resulting from service, testing, adjustment, installation, maintenance, alteration, or modification in any way by someone other than MOTOROLA, BINATONE or its authorized service centers, are excluded from coverage.

Altered Products. Products or Accessories with (a) serial numbers or date tags that have been removed, altered or obliterated; (b) broken seals or that show evidence of tampering; (c) mismatched board serial numbers; or (d) nonconforming or non-Motorola branded housings, or parts, are excluded from coverage.

Communication Services. Defects, damages, or the failure of Products or Accessories due to any communication service or signal you may subscribe to or use with the Products or Accessories is excluded from coverage.

How to Obtain Warranty Service or Other Information?

To obtain service or information, please call:

US and Canada 1-888-331-3383
Email: motorola@encompass.com

You will receive instructions on how to ship the Products or Accessories at your expense and risk, to a BINATONE Authorized Repair Center.

To obtain service, you must include: (a) the Product or Accessory; (b) the original proof of purchase (receipt) which includes the date, place and seller of the Product; (c) if a warranty card was included in your box, a completed warranty card showing the serial number of the Product; (d) a written description of the problem; and, most importantly; (e) your address and telephone number.

These terms and conditions constitute the complete warranty agreement between you and BINATONE. regarding the Products or Accessories purchased by you, and supersede any prior agreement or representations, including representations made in any literature publications or promotional materials issued by BINATONE. or representations made by any agent employee or staff of BINATONE, that may have been made in connection with the said purchase.

FCC, ACTA and Industry Canada (IC) Regulations

Warning: Changes or modifications to this equipment not expressly approved by the party responsible for compliance could void the user’s authority to operate the equipment.

NOTE: This equipment has been tested and found to comply with the limits for a Class B digital device, pursuant to Part 15 of the FCC Rules. These limits are designed to provide reasonable protection against harmful interference in a residential installation. This equipment generates, uses and can radiate radio frequency energy and, if not installed and used in accordance with the instructions, may cause harmful interference to radio communications.

However, there is no guarantee that interference will not occur in a particular installation. If this equipment does cause harmful interference to radio or television reception, which can be determined by turning the equipment off and on, the user is encouraged to try to correct the interference by one or more of the following measures:

- Reorient or relocate the receiving antenna.
- Increase the separation between the equipment and receiver.
- Connect the equipment into an outlet on a circuit different from that to which the receiver is connected.
- Consult the dealer or an experienced radio/TV technician for help.

This device complies with part 15 of the FCC Rules. Operation is subject to the following two conditions: (1) This device may not cause harmful interference, and (2) this device must accept any interference received, including interference that may cause undesired operation.

This device complies with Industry Canada licence-exempt RSS standard(s). Operation is subject to the following two conditions: (1) this device may not cause interference, and (2) this device must accept any interference, including interference that may cause undesired operation of the device.

This Class B digital apparatus complies with Canadian requirement: CAN ICES-3 (B)/NMB-3(B)

Doc Title :	Product Data – User’s Guide	Revision :	R.00
Model :	MBP482	Page(s) :	17 of 17

This device complies with the FCC RF radiation exposure limits set forth for an uncontrolled environment.

Caution: To maintain the compliance with the FCC’s RF exposure guideline, place the baby unit at least 20 cm from nearby persons."

8 TECHNICAL SPECIFICATIONS

BABY UNIT UNIT:

Frequency	2407.5 - 2475 MHz
Channels	21
Operating temperature	5°C - 45°C
Image sensor	Color CMOS 0.3M Pixels
Lens	f 2.7mm, F 2.6
Power supplier	Ten Pao
	Models: UL - S003AKU0600040
	UK - S003GB0600040
	EU - S003GV0600040

For pluggable equipment, the socket-outlet (power adaptor) shall be installed near the equipment and shall be easily accessible

Power supply adaptor (UL)	Input 100-120VAC, 60Hz, 150mA
Power supply adaptor (UK/EU)	Input 100-240VAC, 50/60Hz, 150mA

Rating Output 6VDC, 400mA.

PARENT UNIT:

Frequency	2407.5 - 2475 MHz
Channels	21
Operating temperature	5°C - 45°C
Display	2.4" diagonal TFT LCD
Brightness control	5 steps
Battery supplier	GPI (GP80AAAHC3BMXZ)
Battery rating	3.6V 800mAh Ni-MH battery pack
Power supplier	Ten Pao
	Models: UL - S003AKU0600040
	UK - S003GB0600040
	EU - S003GV0600040

For pluggable equipment, the socket-outlet (power adaptor) shall be installed near the equipment and shall be easily accessible

Power supply adaptor (UL)	Input 100-120VAC, 60Hz, 150mA
Power supply adaptor (UK/EU)	Input 100-240VAC, 50/60Hz, 150mA
Rating	Output 6VDC, 400mA.

Specifications are subject to change without prior notice.



motorola

Manufactured, distributed or sold by Binatone Electronics International LTD., official licensee for this product. MOTOROLA and the Stylized M Logo are trademarks or registered trademarks of Motorola Trademark Holdings, LLC. and are used under license. All other trademarks are the property of their respective owners.
© 2016 Motorola Mobility, LLC. All rights reserved.
Version 1.0

Printed in China