



motorola



USER'S GUIDE

Smart Air Purifier

Model: MBP87SN

The features described in this guide are subject to modifications without prior notice.

Welcome...

to your new Motorola air purifier MBP87SN!

Thank you for purchasing your new Motorola smart air purifier!

The Air Purifier is designed to let you manage and maintain it while at work, on the road via "Hubble Connect for Smart Nursery" App. Featuring Visual Air Quality LED Indicator, true Hepa Filter that removes 99.97% of airborne particles including allergens, pollen, dust mites, and pet dander, soothing Nightlight and UV-C Light that is used to kill germs without the use of any chemicals. The Air Purifier freshens air in your room.

Please keep your original dated sales receipt for your records. For warranty service of your Motorola product, you will need to provide a copy of your dated sales receipt to confirm warranty status. Registration is not required for warranty coverage.

For product related questions, please call:

US and Canada 1-888-331-3383

E-mail: support@motorolastore.com

On the Web: www.motorolastore.com/support

This User's Guide has all the information you need to make the most out of your product.

Please read the Safety Instructions on page 5 before you install the unit.

Inside the Box

- 1 x Air Purifier with Activated Carbon Filter and True HEPA Filter installed
- 1 x Quick Start Guide

Overview of the Air Purifier

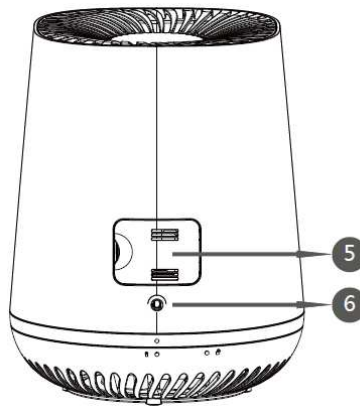
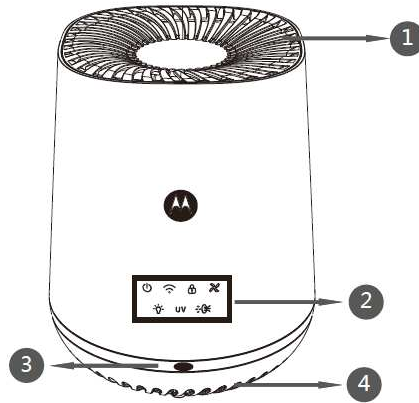

1. Air Outlet	4. Air Inlet
2. Control Panel (with LED Backlight)	5. Air Quality Sensor Door
3. Air Quality Indicator	6. Power cord





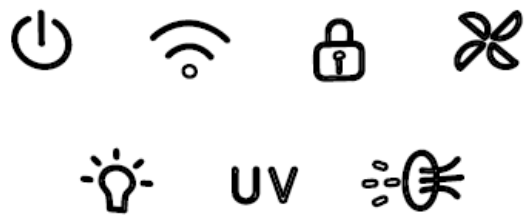

Understand the Air Quality Indicator

Color of the air quality light	Air quality level
Blue	Good
Yellow	Fair
Red	Bad







Note:
The built-in air quality sensor measures the air quality and automatically selects the appropriate color of the air quality light. When the air is clean, the color of the air quality light is in blue. When the air quality deteriorates, the color of the air quality light changes to yellow or red.

Control Panel Icons



	Power ON/OFF Button		Night Light Button (Fully bright, Half bright)
	Wi-Fi Button		UV C Light Button
	Child Lock Button		Filter Change Reminder Button
	Fan Speed Button (AUTO, 1, 2, 3)		

Operation of the Touch Control Buttons

	ON/OFF Button	<p>Tap to turn the unit ON or OFF. When the unit is turned on, it will work at HI-speed mode (default), with the SPEED button white backlight and HI-SPEED white LED illuminating.</p>
	WIFI (Pair Key)	<p>Long press this button for 3s when the machine starts up or when in standby, the WIFI button white backlight illuminates as “0.5s on/0.5s off”, the machine goes into Wi-Fi pairing status.</p>
	Child Lock	<p>Press this button for 5s, CHILD LOCK BUTTON white backlight illuminates, other buttons can't be operate in this mode except the Child Lock Button itself.</p>
	Fan Speed Button	<p>Tap to cycle through the speed options (1, 2, 3 or AUTO). The selected speed (1, 2, 3) is showed as White backlight, with AUTO showed as Green backlight but also with a white backlight for speed #1, or 2, or 3 per the environment status.</p>
	Night Light	<ul style="list-style-type: none"> • Fully bright light: Press the button once • Half bright light: Press the button twice • To turn off the night light: Press the button again.
	UV C Light	<ul style="list-style-type: none"> • ON / OFF: Tap to turn the UV light button. • The white backlight LED will flicker when it's time to replace the bulb. Turn off and unplug the unit. Replace the bulb according to directions, then press and hold UV Light button for 5s to reset the system.
	HEPA Filter Replace / Reset Button	<ul style="list-style-type: none"> • The replace HEPA Filter white LED backlight will flicker indicating that it's time to replace the HEPA Filter. Turn off and unplug the unit. Replace the filter according to instructions, then press and hold the button for 5s to reset the system.

1. Safety Instructions	7
2. System Requirements	9
3. Getting Started	10
3.1 The Air Purifier Working Principle.....	10
3.2 Connect Air Purifier to Power Supply.....	11
4. Connecting Devices	12
4.1 User Account and Air Purifier Setup on Android™ Devices...12	
4.1.1 Download Hubble Connect for Smart Nursery App.....12	
4.1.2 Run Hubble Connect for Smart Nursery App on Android™ Device.....	13
4.1.3 Add Air Purifier to Your Smart Nursery Account.....14	
4.2 User Account and Air Purifier Setup on iOS® Devices17	
4.2.1 Download Hubble Connect for Smart Nursery App.....17	
4.2.2 Run Hubble Connect for Smart Nursery App on iOS® Device	17
4.2.3 Add Air Purifier to Your Smart Nursery Account.....18	
5. Overview of Hubble App	21
6. Recommendations for Use and Care	22
7. Replace the HEPA Filter and UV Bulb	23
7.1 Replace the HEPA Filter.....	23
7.2 Replace the UV Bulb.....	25
7.3 Clean the Air Quality Dust Sensor.....	27
8. Troubleshooting	28
9. Disposal of the Device (Environment)	31
10. General Information	32
11. Technical Specifications	37

1. Safety Instructions

READ AND SAVE THESE INSTRUCTIONS.

WARNING

This product is compliant with all relevant electromagnetic field standards and is, when handled as described in the User's Guide, safe to use. Therefore, always read the instructions in this User's Guide carefully before using the device, and save it for later use.

- The air purifier is intended for indoor use only. Do not operate the air purifier outdoors.
- Make sure all filters are properly installed before you switch on the appliance.
- Always unplug the air purifier before moving or cleaning the unit, opening the grill, changing the filters and whenever the unit is not in use. To disconnect the unit, be sure to pull the plug and not the cord.
- Plug the appliance directly into a 120V~ electrical outlet. When it plugs to 220V power, the unit will not function but buzz to remind the users to change the right voltage of 110-120V power supply.
- Keep the cord out of heavy traffic areas. To avoid fire hazard, NEVER put the cord under rugs, near heat registers, radiators, stoves, or heaters.
- To protect against electrical hazards, DO NOT immerse the appliance in water or other liquids. Do not use near water.
- The appliance should only be used by children under adult supervision.
- NEVER drop or insert any objects into the air inlet and outlet of the unit.
- If the supply cord is damaged, it must be replaced by the manufacturer, its service agent or similarly qualified persons in order to avoid hazard.
- Always handle the air purifier with dry hands to avoid electric shock.
- NEVER place the appliance on a soft surface, such as a bed or sofa, as this could cause the unit to tip over and block the air inlet or outlet grills.
- Do NOT place anything on top of unit.
- Do NOT run cord under carpeting.
- Do NOT use this appliance when you have used indoor smoke-type insect repellents or in places with oil residues, burning incense, or chemical fumes.
- Do NOT use the appliance in a room with major temperature changes, as this may cause condensation inside the appliance.
- To prevent interference, placed the appliance at least 2 m (6.6 feet) away from electrical appliances that use airborne radio waves such as TVs, radios, and radio-controlled clocks.
- Do NOT use the appliance in wet surroundings with high ambient temperatures, such as the bathroom, toilet, or kitchen.
- Do NOT place the appliance directly below an air conditioner to prevent condensation from dripping onto the appliance.
- Keep the appliance away from heated surfaces and open flames.
- DO NOT attempt to repair or adjust any electrical or mechanical functions on this unit. Doing so will void your warranty. The inside of the unit contains no user serviceable parts. All servicing should be performed by the manufacturer or its service agent.

- Use appliance only for intended household use as described in this user manual. Any other use not recommended by the manufacturer may cause fire, electric shock or injury to persons.
- Always turn the appliance off before unplugging it.
- This product is not a toy. Do not allow children to play with it.
- Keep this User's Guide for future reference.
- CAUTION: Do NOT use gasoline, benzene, thinner, harsh cleaners, etc. on and/or in the unit while cleaning as they will damage the product. NEVER use alcohol or other solvents.
- Place the air purifier on a smooth, level surface, such as a table.

Important guidelines for installing the air purifier

- Use of other 2.4GHz products, such as other wireless networks, Bluetooth® systems or microwave ovens may cause interference with this product. Keep the air purifier away from these types of products, or turn them off if they appear to be causing interference.
- Always ensure that you have a good Wi-Fi® connection available.

2. System Requirements

Smartphones/Tablets: Android™ and **iOS® only.**

System requirement: iOS8.0, Android™ 4.4 or higher

For more information please visit: <https://hubbleconnected.com/requirements>

3. Getting Started

3.1 The Air Purifier Working Principle

STAGE 1 - The air firstly flows through the carbon filter which acts as a pre-filter and captures larger particles, thus extending the life of the true HEPA filter.

STAGE 2 – The filtered air goes through the UVC Light to eliminate airborne germs.

STAGE 3 – The cleaned air goes out of the appliance from the air outlet.

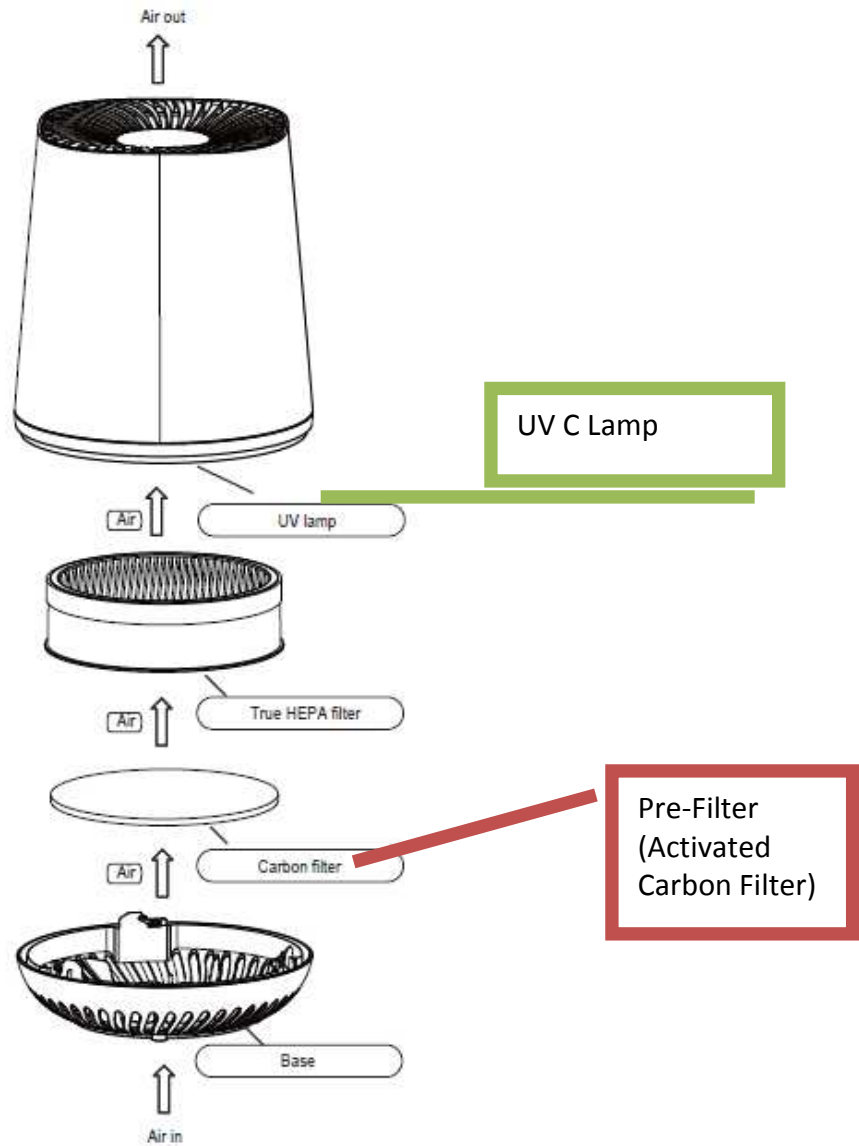

3.2 Connect Air Purifier to Power Supply

1. Connect the Smart Air Purifier to the main power socket.

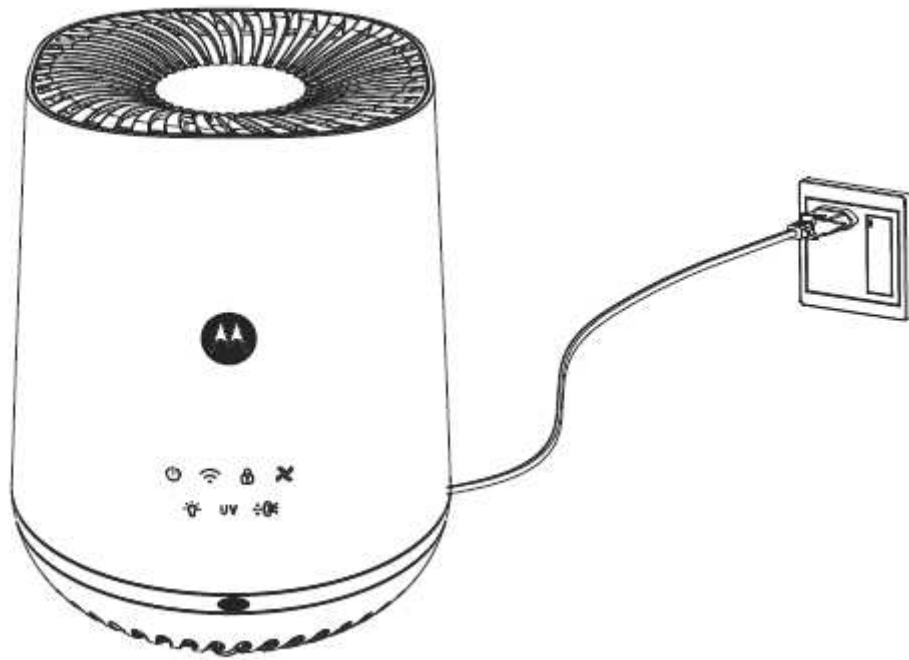

2. The Power ON/OFF button will light up momentarily and then continuously blink until tap to turn on the Air Purifier.

4. Connecting Devices

How Does It Work?

Air Purifier

Air Purifier



When a user tries to access the Air Purifier, our *Smart Nursery* server authenticates the user's identity and permits access.

Note

You can only setup via a compatible smartphone or tablet and not via a PC.

4.1 User Account and Air Purifier Setup on Android™

Devices

What you need

- Air Purifier
- Device with Android™ system 4.4.2 or higher

4.1.1 Download Hubble Connect for Smart Nursery App

- Go to Google Play™ Store to search for *Hubble Connect for Smart Nursery*.
- Download *Hubble Connect for Smart Nursery* App and install it on your Android™ device



4.1.2 Run Hubble Connect for Smart Nursery App on

Android™ device

- Ensure that your Android™ Device is connected to the Wi-Fi® router or mobile network.

- Run *Hubble Connect for Smart Nursery App*, tap SIGNUP and follow the in-app instructions to create your *Smart Nursery Account*. By signing up, you agree to our Terms & Conditions. (Pictures A1 & A2)

Note

If you already have a Smart Nursery App account, please tap LOGIN by entering your account information and go to the next steps.

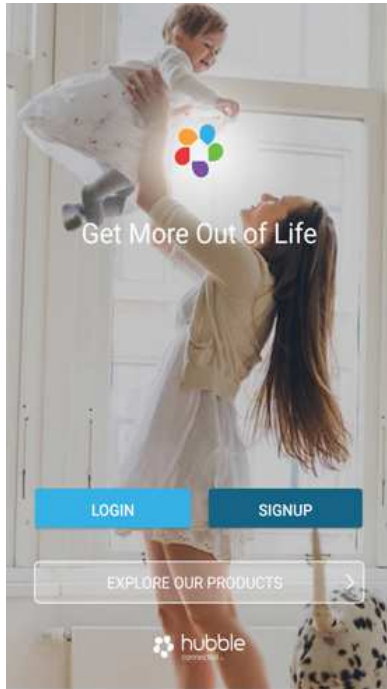

(A1)

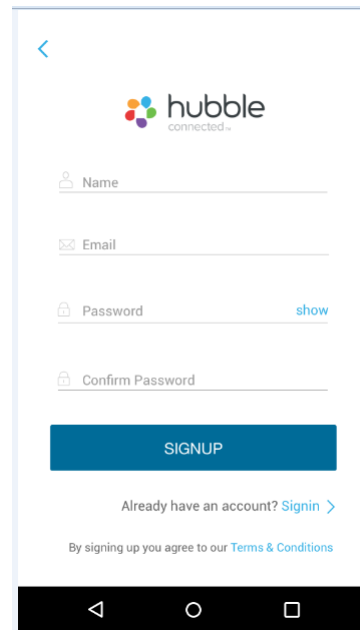

(A2)

4.1.3 Add Air Purifier to your Smart Nursery account

- Switch on your Humidifier, then press and hold the Wi-Fi / Power On-Off key for 3 seconds to enter Wi-Fi pairing/ setting mode.

- Tap on Smart Humidifier or press Add Device then tap on Smart Humidifier to enter Humidifier setup mode. (Picture A3)

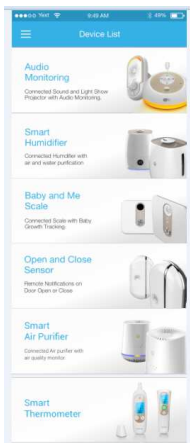

(A3)

- Tap on Skip to Setup, then tap Next to search for Humidifier. (Pictures A4 & A5)

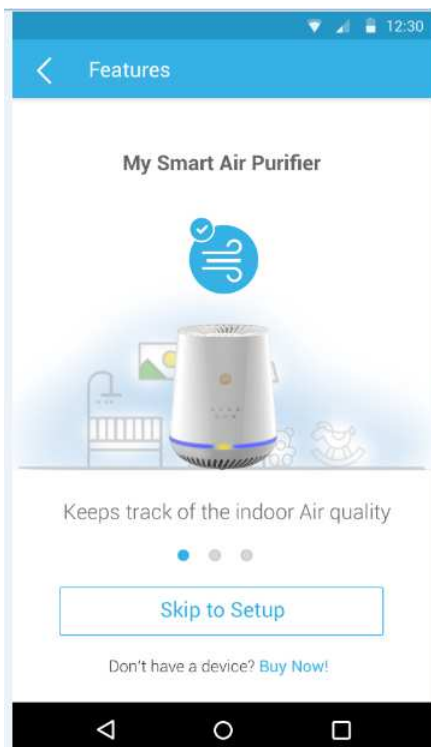

A4

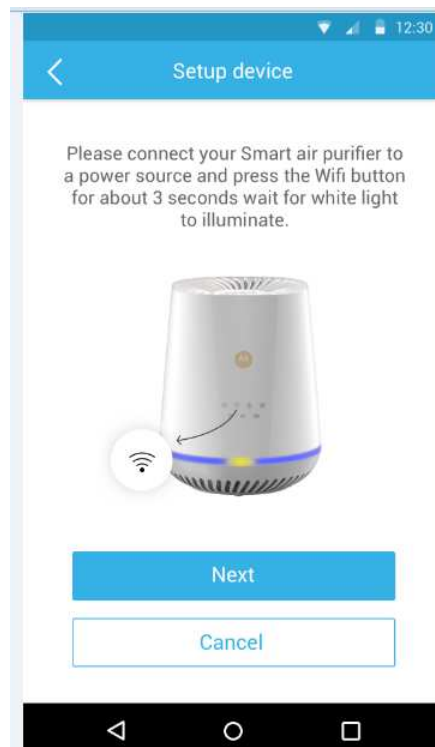

A5

- The device SSID can be found on your Android™ Device. Tap the SSID to confirm. (Picture A6)

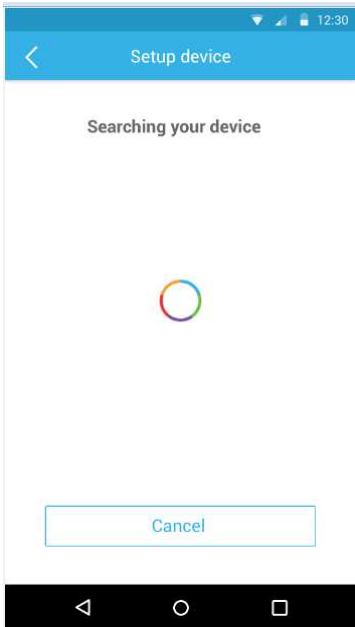

A6

Air Purifier is detected. Tap Next to proceed to the next step.
(Picture A7)

- You need a Wi-Fi® network to connect to your Air Purifier. Tap Search to start network searching. (Picture A8)

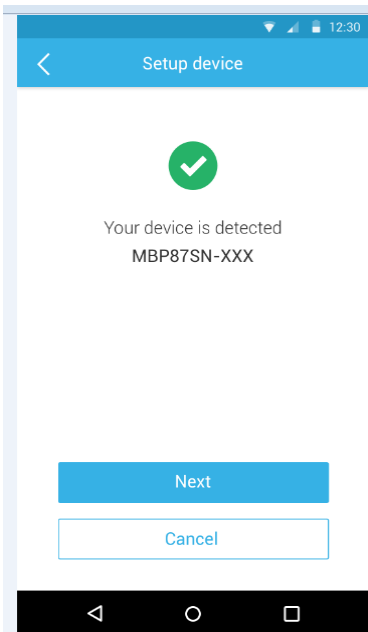

(A7)

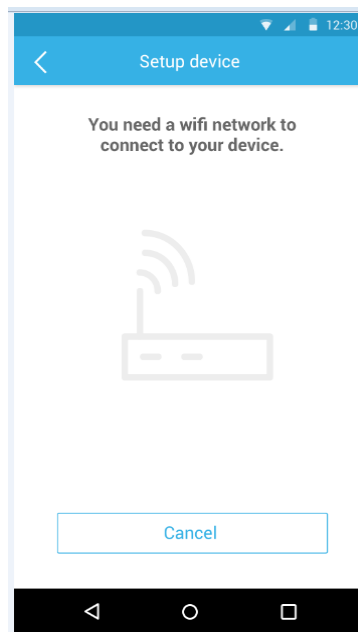

(A8)

Select a Wi-Fi® network from the network list, enter Wi-Fi® password and then tap Submit. (Picture A9)

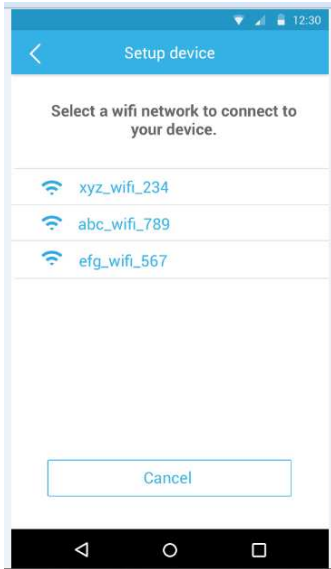

A9

It will take a few minutes for Air Purifier to connect to the Wi-Fi® network. Tap Get Started when Air Purifier is successfully connected to *Hubble Connect for Smart Nursery App*. (Pictures A10 & A11)

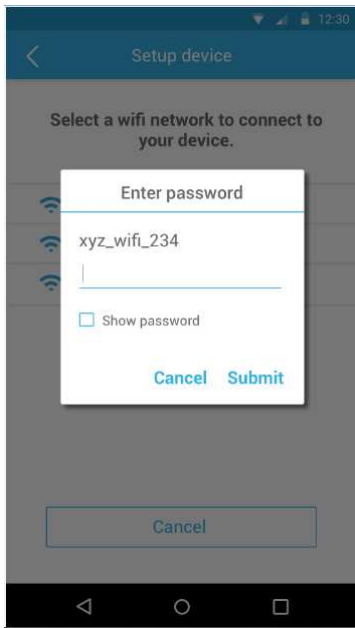

A10 -

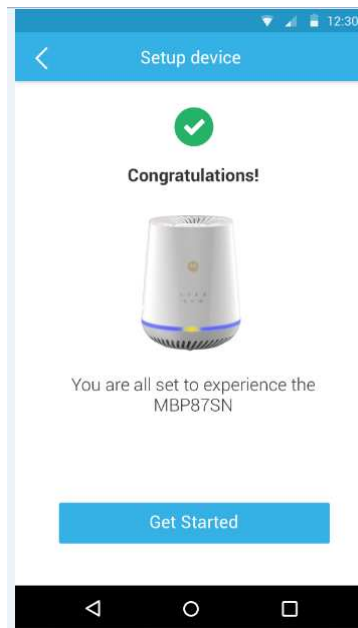

A11

Note

If you fail to complete the setup process, press and hold the Wi-Fi key until the backlight blinks to enter registration mode and repeat the above steps again.

4.2 User Account and Air Purifier Setup on iOS®

Devices

What you need

- Air Purifier
- Device with iOS® 8.0 or higher

4.2.1 Download Hubble Connect for Smart Nursery App

- Go to App Store to search for *Hubble Connect for Smart Nursery*.
- Download *Hubble Connect for Smart Nursery* App and install it on your iOS® device



4.2.2 Run Hubble Connect for Smart Nursery App on iOS® Device

- Ensure that your iOS® device is connected to the Wi-Fi® router or mobile network.
- Run *Hubble Connect for Smart Nursery* App, tap SIGNUP and follow the in-app instructions to create your *Smart Nursery* Account. By signing up, you agree to our Terms & Conditions. (i1 & i2)

Note

If you already have a Smart Nursery App account, please tap LOGIN by entering your account information and go to the next steps.

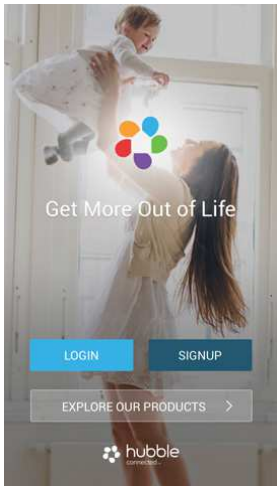

(i1)

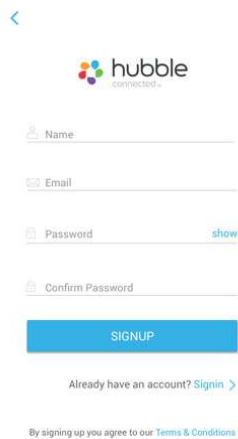

(i2)

4.2.3 Add Humidifier to your Smart Nursery account

- Switch on your Humidifier, then press and hold the Wi-Fi / Power On-Off key for 3 seconds to enter Wi-Fi pairing/ setting mode.
- Tap on Smart Humidifier to enter Humidifier setup mode. (Picture

i3)

- Skim over the main features of your Humidifier, then tap Skip To Setup. (Picture i4)

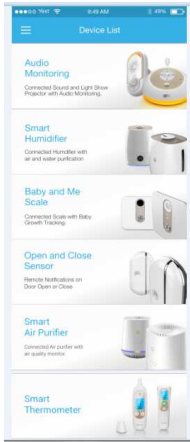

(i3)



(i4)

The following setup instructions will appear on the screen. (Picture i5)

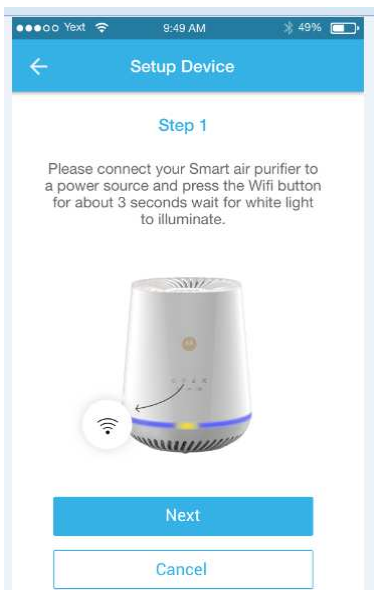

(i5)

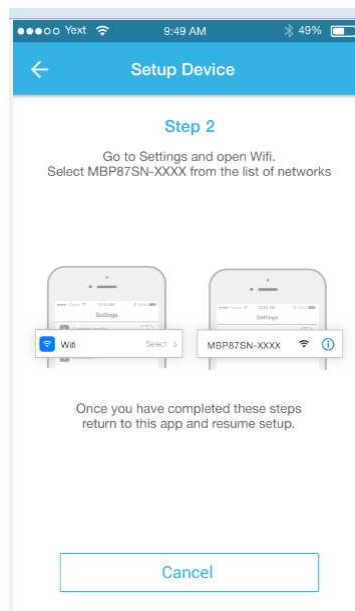

(i6)

Follow the on-screen instructions.

- Go to Settings > Wi-Fi menu on your iOS® device. (Pictures i6)
- Select the SSID of your Air Purifier from the list of networks. (Pictures i8)

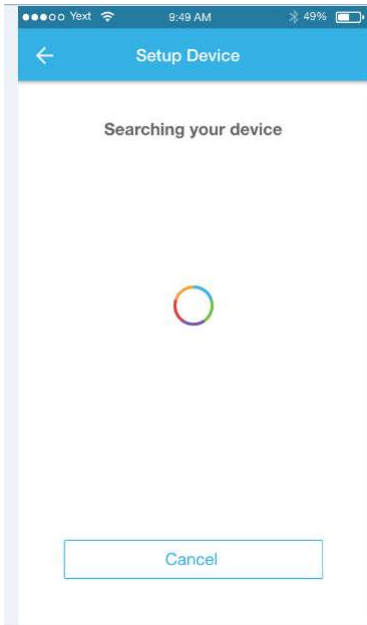

(i7)

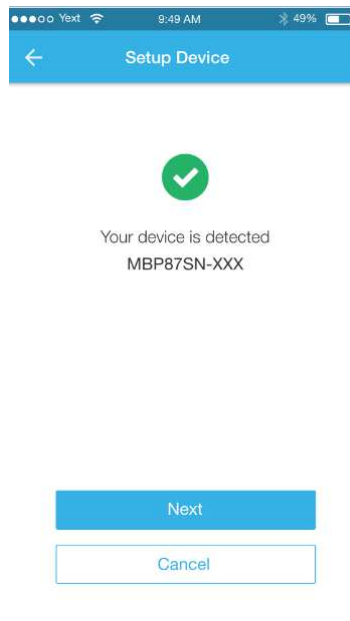

(i8)

Return to the Smart Nursery App to resume setup.

- Select your Wi-Fi® network and tap Search. (Picture i10)
- Enter your Wi-Fi® password and tap OK. (Picture i11)



(i9)

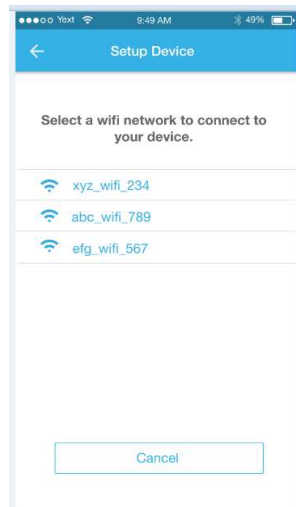

(i10)

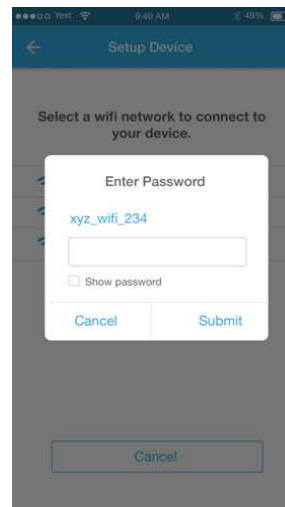

(i11)

It will take a few minutes for Air Purifier to connect to the Wi-Fi® network before showing the connection status (Pictures i12)

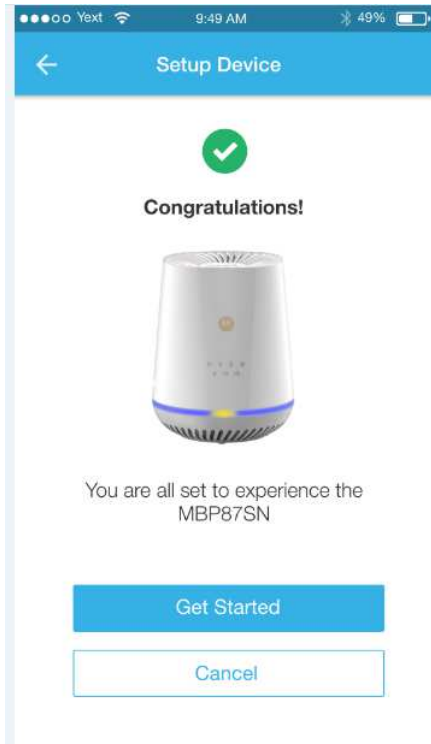









(i12)

Note

If you fail to complete the setup process, press and hold the Wi-Fi key until the backlight blinks to enter registration mode and repeat the above steps again.

5. Overview of Hubble App

	Fan Speed Button (AUTO, 1, 2, 3)	Tap to select the speed level (1 - 3 or Auto)
--	-------------------------------------	---

		
	Child Lock	To activate and deactivate the child lock feature.
	Select Timer (in hours)	Tap to switch timer ON/OFF, then select the operation hours from 1 hour to 12 hours
	Night Light	<ul style="list-style-type: none"> • Tap button once to turn ON. • Tap button to select "Fully Bright Light". • Tap button to select "Half Bright Light". • Tap button to turn OFF.
	Air Quality Status View	<p>The built-in air quality sensor measures the air quality and automatically selects the appropriate color of the air quality light.</p> <p>The following colors represent the measured air quality.</p> <p>Blue = good air quality Yellow = fair air quality Red = bad air quality</p>
	UV Light Change Reminder Button	<ul style="list-style-type: none"> • ON / OFF: Tap to turn the UV light button. • Message appears when it's time to replace the bulb. Turn off and unplug the unit. Replace the bulb according to directions, then press and hold UV Light button (control panel) for 5s to reset the system.
	HEPA Filter Replace / Reset Button	<p>Message appears when it's time to replace the HEPA Filter.</p> <p>Turn off and unplug the unit. Replace the filter according to instructions, then press and hold the button (control panel) for 5s to reset the system.</p>
	Motorola Shopping Cart	By tapping on the button, you will be directed to the Motorola website and you can shop the replacement HEPA filter and UV bulb and other products.

6. Recommendations for Use and Care

- The appliance is only intended for household use as described in this manual. Any other use not recommended by the manufacturer may cause fire, electric shock or injury to persons.
- During the device operation, NEVER block the air openings, grills/ outlets or place on a soft surface such as a bed or sofa, as this could cause the unit to tip over, blocking the air inlet or outlet opening.
- Before replace the true-HEPA filter or UV bulb, make sure you unplug the air purifier from the main power socket in order to prevent the risk of electrical shock.
- Do not let the area around the air purifier to become damp or wet. Please also not immerse the device into water or other liquids in order to protect against electrical hazards.
- Clean the air purifier as user's guide when the product will not be in frequent use. Before storage, make sure all the parts are clean and dry. Store the air purifier in a dry place. After storage, clean the air purifier again and remove any dust on the outside.
- Please NOT operate the appliance with a damaged cord or plug. If the motor fan fails to rotate, OR if the device has been dropped or damaged in any manner, leading to the appliance malfunctions, DO NOT operate it to avoid any harm or injury risk for users.
- Never block the air openings, grills/outlets or place on a soft surface such as a bed or sofa, as this could cause the unit to tip over, clocking the air intake or outtake opening.
- During the device operation, it may cause interference near any other 2.4 GHz products, such as other wireless networks Bluetooth systems or microwave ovens. Keep the air purifier away from these types of products, or turn them off if interference appeared.
- Every effort has been made to ensure high standards of reliability of your air purifier. However, if something does go wrong, please do not try to repair it yourself - contact Customer Service for assistance.
- Use a clean, dry, soft cloth to wipe the external surface of the unit.

7. Replace HEPA Filter and UV C Bulb

You will be notified by LED lights on the control panel and the Smart Nursery App when it's time to change the activated carbon filter and the HEPA Filter.

7.1 Replace the HEPA Filter

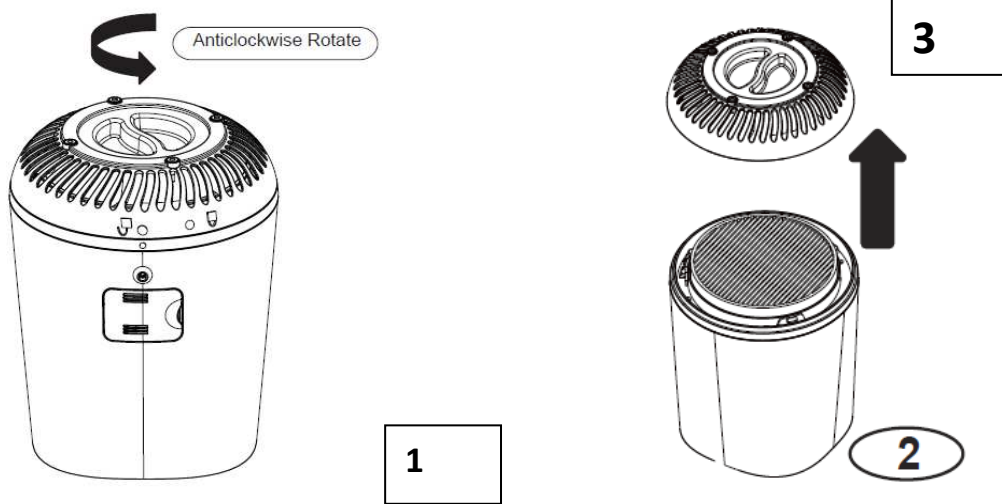

Step 1) Turn off and unplug the unit!

Step 2) Rotate the bottom cover in anticlockwise direction until matching the unlock icon.
 Step 3) Remove the bottom cover after rotation

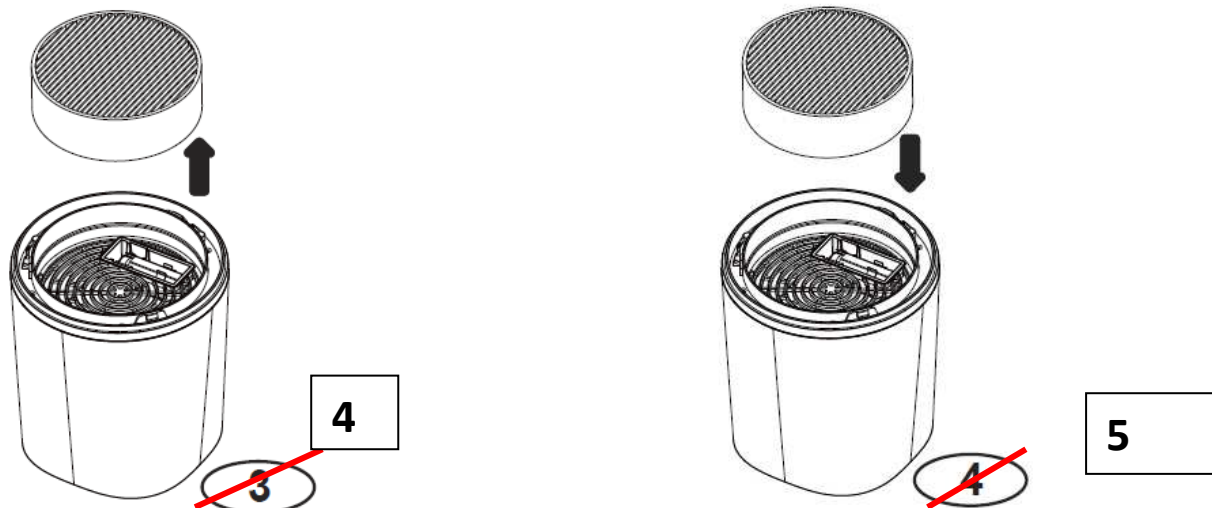

Step 4) Remove the HEPA filter after open the bottom cover

Step 5) Install a new HEPA filter in the correct position.

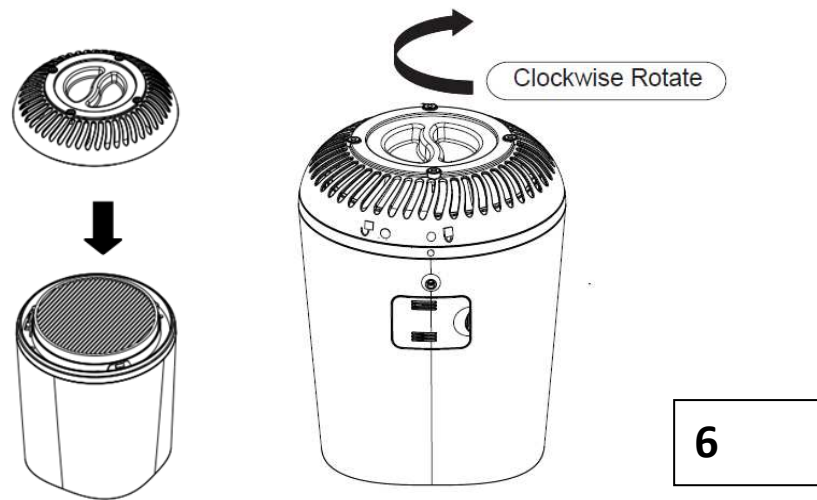

Step 6) Put the bottom cover back to the unit and rotate in clockwise direction until matching the Lock icon.

The white LED Filter Change Reminder Button will blink continuously indicating that it's time to replace the filter. Replace the HEPA filter according to the directions, then press and hold the  button for 5s to reset the system.

Checking and Maintaining Filter

- Maintain the Activated Carbon Filter and HEPA Filter by checking it frequently.
- When the filter turns from white to grey or black, it should be replaced.
- Depending on air quality conditions, you may need to replace it more frequently.

IMPORTANT: Do NOT try to wash and re-use combination filter. Please contact service at 1-888-331-3383 or visit our website: www.motorolastore.com to purchase a replacement filter.

NOTE: The combination filter is one filter system. The multi layers include the True Hepa /Activate Carbon filter.

7.2 Change the UV Bulb

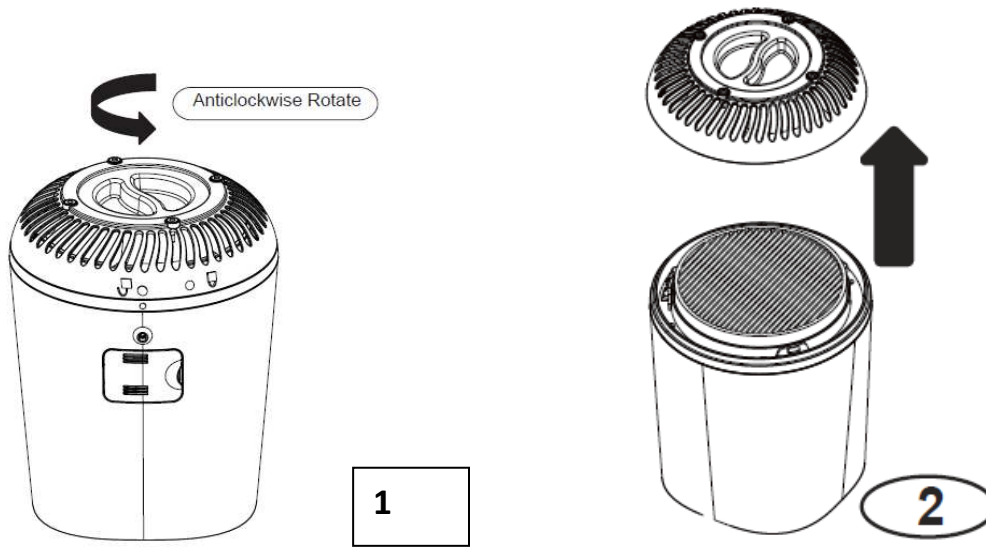

- Step 1) Turn off and unplug the unit.
- Step 2) Rotate the bottom cover in anticlockwise direction until matching the Unlock icon.
- Step 3) Remove the bottom cover after rotation

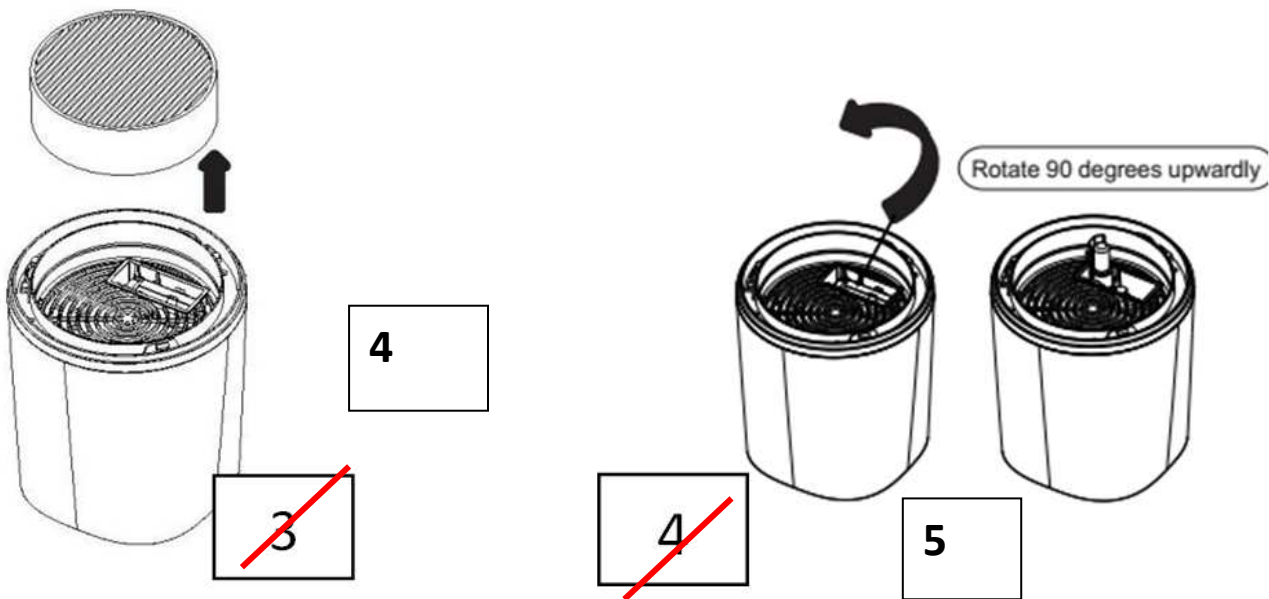

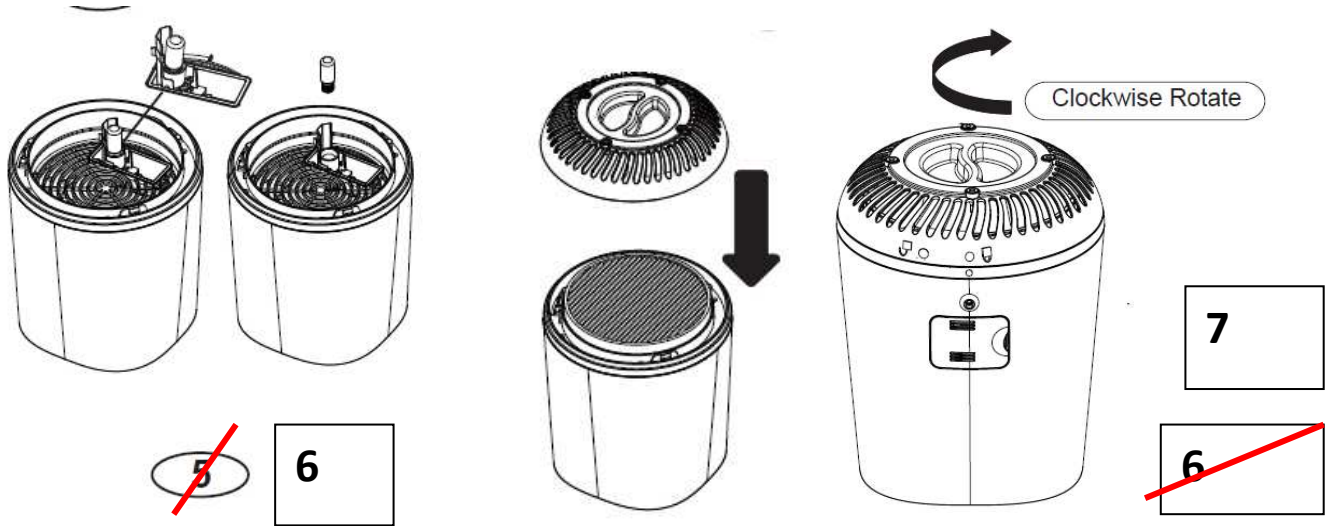

- Step 4) Remove the true-HEPA filter after open the bottom cover
- Step 5) Rotate the UV bulb shield 90 degrees upwardly.



Step 6) Carefully rotate the UV bulb at 5 degrees by using a clean cloth in anticlockwise direction, and then pull the UV bulb straight out of the unit. The UV lamp is reinstalled by sliding it clockwise with a clean cloth, rotating in horizontal and back into the unit.
 Step 7) Put the bottom cover back to the unit and rotate it in clockwise direction until matching the Lock icon for firmly locking.

NOTE: The white LED UV C Light Button will blink continuously indicating that it's time to replace the bulb. Replace the bulb according to the directions, then press and hold the button for 5s to reUV the system.

Replacement UV C Bulb: Please contact service at 1-888-331-3383 or visit our website: www.motorolastore.com to purchase a replacement bulb.

 LAMP CONTAINS MERCURY 
<p>Manage in accordance with Spills, Disposal and Site Cleanup Requirements. In case of breakage, follow clean-up procedures provided by contacts below.</p>
<p>www.epa.gov/cflcleanup 1-866-284-4010</p>

7.3 Clean the Air Quality Dust Sensor

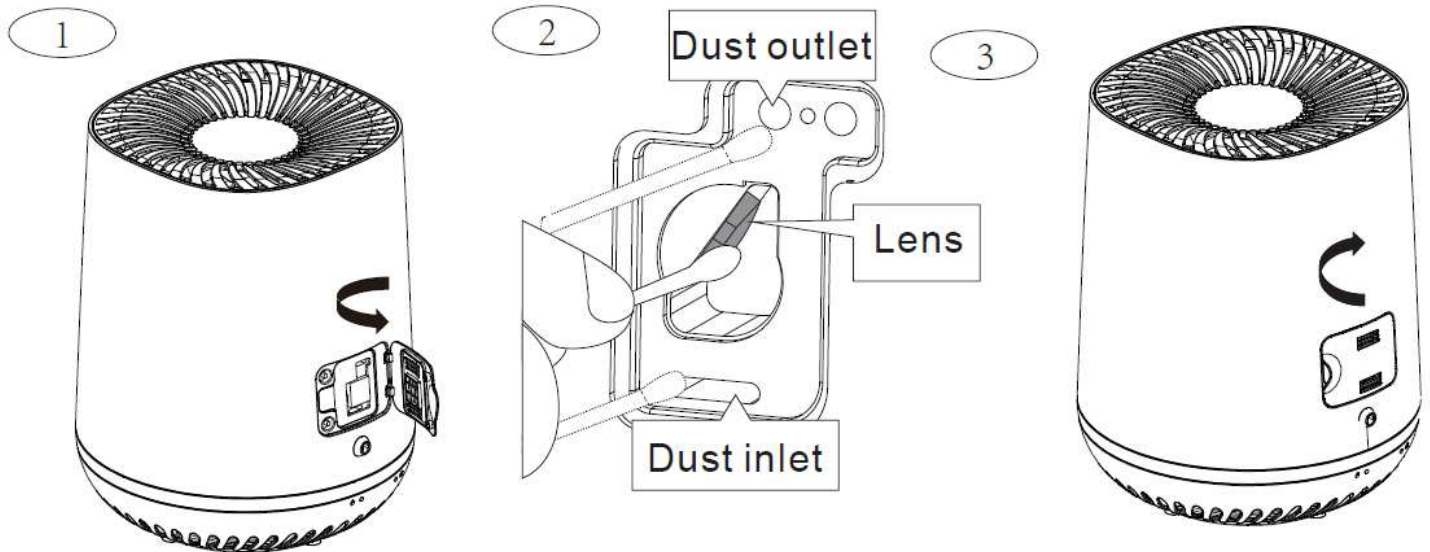



Cleaning Method:

- 1) Open the air quality sensor door.
- 2) Clean the lens and dust inlet/outlet with a lightly moistened cotton swab. Afterwards, dry the lens and dust inlet/outlet with a dry cotton swab.
- 3) Close the air quality sensor door.

Note: When the humidity level in the room is very high, it is possible that condensation develops on the air quality sensor. As a result, the air quality light may indicate that the air quality is bad even though it is good. In this case, you have to clean the air quality sensor on a periodically basis, i.e. every 2 months.

8. Troubleshooting

Problem Category	Problem Description / Error	Solution
Account	I am unable to login even after registration.	Please check your user name and password.
Account	What to do if forget the password?	Click on the "Forgot Password" link on https://app.hubbleconnected.com/#lostpassword OR on your Android™ or iOS application. An e-mail will be sent to your registered e-mail address.
Account	I am unable to receive a new password although I have used the "Forgot password" option.	<ol style="list-style-type: none"> 1) The e-mail might have been sent to your Junk Mail Folder. Please check it. 2) There might be a delay to get your e-mail. Please wait a few minutes and refresh your e-mail account.
Account	I receive an error message saying: "E-mail ID is not registered".	Please ensure that you have registered with us. Tap SIGN UP to create an account.
Connectivity Issue	I get a message: We are having problems accessing your Device. This could be due to the lack of an internet connection. Please wait and try again later.	<ol style="list-style-type: none"> 1. Please try again in a few minutes. This could be because of any issue with your internet connection. 2. If the problem remains, please restart your Device to check if this fixes the problem. 3. Please restart your Wireless Router.
Connectivity Issue	I am unable to access the device.	Please check if the Device is within Wi-Fi range. If the LED on your Device is flashing slowly, please try to move the Device closer to the router for better Wi-Fi connectivity and try again.
Functions	The unit will not operate.	<ol style="list-style-type: none"> 1) Please check and make sure the unit is properly plugged and outlet is energized. 2) Please make sure the unit has been turned ON. 3) Please check and make sure the filter is properly installed and the rear grill is seated correctly.

Functions	The airflow that comes out of the air outlet is significantly weaker than before.	<ol style="list-style-type: none"> 1) Please make sure nothing is blocking air inlet and filtered air outlets. 2) Please check the filter condition and replace it if necessary. 3) Please check if you have removed all packaging . 4) The air quality sensor is wet. The humidity level in your room is high and causes condensation. Make sure that the air quality sensor is clean and dry (see “Clean the air quality sensor”)
Functions	Why I heard excessive noise during the device running?	<ol style="list-style-type: none"> 1) Please check and make sure parts are firmly positioned in place. 2) Please check if you have removed all the packaging material from the HEPA filter.
Functions	The air purifier still indicates that I need to replace a filter; but I already did.	<p>Perhaps you did not press the “Filter Change Reminder Button”</p>  <p>Plug in the air purifier, press ON/OFF button and press and hold the</p>  <p>button (control panel) for 5 seconds.</p>

Functions	Why is the night light continuously blinking?	It's the reminder to clean the “air quality sensor”, see 7.3 ‘clean the air quality sensor’.
-----------	---	--

Functions	How to reset the filter timer after replacing the filter.	Under power on mode, long press the Filter Change/Reset Button (control panel) for 5s, the air quality indicator will blink as reminder, and then continuously press another 3s to finish resetting.
Functions	The UV lamp button has been on continuously.	Please replace the UV lamp per the User's Guide and hold the UV button (control panel) for 5s to reset the system
General	How to download the App for Android™ and iOS devices?	<p>Android™:</p> <ul style="list-style-type: none"> - Open the Google Play on your Android™ device. - Select Search - Type in "Hubble Connect for Smart

		<p>Nursery"</p> <ul style="list-style-type: none"> - The results will show the Hubble App - Select to install it. <p>iOS Device:</p> <ul style="list-style-type: none"> - Open the App StoreSM - Select Search - Type in "Hubble Connect for Smart Nursery" - The results will show the Hubble App - Select to install it.
General	Which platforms are supported for accessing my Device?	<p>Minimum requirement:</p> <p>Android™ 4.4.2</p> <p>iPhone / iPad iOS version 8.0</p>
Installation	I am unable to match the air inlet grill onto the device housing.	Please line up the Lock icon (🔒) on the air inlet grill with the power cord outlet on the device housing, so that ensure the grill is securely locked in place.
Power indication light off, does not work	No power supply	Connect power supply, switch on.

9. Disposal of the Device (Environment)

At the end of the product life cycle, you should not dispose of this product with normal household waste. Take this product to a collection point for the recycling of electrical and electronic equipment. The symbol on the product, user's guide and/or box indicates this. Some of the product materials can be re-used if you take them to a recycling point. By reusing some parts or raw materials from used products you make an important contribution to the protection of the environment. Please contact your local authorities in case you need more information on the collection points in your area.

Dispose of the battery pack in an environmentally-friendly manner according to your local regulations.



10. General Information

If your product is not working properly....

1. Read this User's Guide.
2. Visit our website: www.motorolastore.com
3. Contact Customer Service at

US and Canada 1-888-331-3383

E-mail: support@motorolastore.com

Consumer Products and Accessories Limited Warranty

("Warranty")

Thank you for purchasing this Motorola branded product manufactured under license by Binatone Electronics International Ltd ("BINATONE").

What Does this Warranty Cover?

Subject to the exclusions contained below, BINATONE warrants that this Motorola branded product ("Product") or certified accessory ("Accessory") sold for use with this product is manufactured to be free from defects in materials and workmanship under normal consumer usage for the period outlined below. This Warranty is your exclusive warranty and is not transferable.

Who is covered?

This Warranty extends only to the first consumer purchaser, and is not transferable.

What will BINATONE do?

BINATONE or its authorized distributor at its option and within a commercially reasonable time, will at no charge repair or replace any Products or Accessories that does not conform to this Warranty. We may use functionally equivalent reconditioned/ refurbished/ pre-owned or new Products, Accessories or parts.

What Other Limitations Are There?

ANY IMPLIED WARRANTIES, INCLUDING WITHOUT LIMITATION THE IMPLIED WARRANTIES OF MERCHANTABILITY AND FITNESS FOR A PARTICULAR PURPOSE, SHALL BE LIMITED TO THE DURATION OF THIS LIMITED WARRANTY, OTHERWISE THE REPAIR OR REPLACEMENT PROVIDED UNDER THIS EXPRESS LIMITED WARRANTY IS THE EXCLUSIVE REMEDY OF THE CONSUMER, AND IS PROVIDED IN LIEU OF ALL OTHER WARRANTIES, EXPRESS OR IMPLIED. IN NO EVENT SHALL MOTOROLA OR BINATONE BE LIABLE, WHETHER IN CONTRACT OR TORT (INCLUDING NEGLIGENCE) FOR DAMAGES IN EXCESS OF THE PURCHASE PRICE OF THE PRODUCT OR ACCESSORY, OR FOR ANY INDIRECT, INCIDENTAL, SPECIAL OR CONSEQUENTIAL DAMAGES OF ANY KIND, OR LOSS OF REVENUE OR PROFITS, LOSS OF BUSINESS, LOSS OF INFORMATION OR OTHER FINANCIAL LOSS ARISING OUT OF OR IN CONNECTION WITH THE ABILITY OR INABILITY TO USE THE PRODUCTS OR ACCESSORIES TO THE FULL EXTENT THESE DAMAGES MAY BE DISCLAIMED BY LAW.

Some jurisdictions do not allow the limitation or exclusion of incidental or consequential damages, or limitation on the length of an implied warranty, so the above limitations or exclusions may not apply to you. This Warranty gives you specific legal rights, and you may also have other rights that vary from one jurisdiction to another.

Products Covered	Length of Coverage
Consumer Products	One (1) year from the date of the products, original purchase by the first consumer purchaser of the product.

Consumer Accessories	Ninety (90) days from the date of the Accessories, original purchase by the first consumer purchaser of the product.
Consumer Products and Accessories that are Repaired or Replaced	The balance of the original warranty or for Ninety (90) days from the date returned to the consumer, whichever is longer.

Exclusions

Normal Wear and Tear. Periodic maintenance, repair and replacement of parts due to normal wear and tear are excluded from coverage.

Batteries. Only batteries whose fully charged capacity falls below 80% of their rated capacity and batteries that leak are covered by this Warranty.

Abuse & Misuse. Defects or damage that result from: (a) improper operation, storage, misuse or abuse, accident or neglect, such as physical damage (cracks, scratches, etc.) to the surface of the product resulting from misuse; (b) contact with liquid, water, rain, extreme humidity or heavy perspiration, sand, dirt or the like, extreme heat, or food; (c) use of the Products or Accessories for commercial purposes or subjecting the Product or Accessory to abnormal usage or conditions; or (d) other acts which are not the fault of MOTOROLA or BINATONE, are excluded from coverage.

Use of Non-Motorola branded Products and Accessories. Defects or damage that result from the use of Non-Motorola branded or certified Products or Accessories or other peripheral equipment are excluded from coverage.

Unauthorized Service or Modification. Defects or damages resulting from service, testing, adjustment, installation, maintenance, alteration, or modification in any way by someone other than MOTOROLA, BINATONE or its authorized service centers, are excluded from coverage.

Altered Products. Products or Accessories with (a) serial numbers or date tags that have been removed, altered or obliterated; (b) broken seals or that show evidence of tampering; (c) mismatched board serial numbers; or (d) nonconforming or non-Motorola branded housings, or parts, are excluded from coverage.

Communication Services. Defects, damages, or the failure of Products or Accessories due to any communication service or signal you may subscribe to or use with the Products or Accessories is excluded from coverage.

How to Obtain Warranty Service or Other Information?

To obtain service or information, please call: 1-888-331-3383

E-mail: support@motorolastore.com

You will receive instructions on how to ship the Products or Accessories at your expense and risk, to a BINATONE Authorized Repair Center.

To obtain service, you must include: (a) the Product or Accessory; (b) the original proof of purchase (receipt) which includes the date, place and seller of the Product; (c) if a warranty card was included in your box, a completed warranty card showing the serial number of the Product; (d) a written description of the problem; and, most importantly; (e) your address and telephone number.

These terms and conditions constitute the complete warranty agreement between you and BINATONE regarding the Products or Accessories purchased by you, and supersede any prior agreement or representations, including representations made in any literature publications or promotional materials issued by BINATONE or representations made by any agent employee or staff of BINATONE, that may have been made in connection with the said purchase.

Responsible Party in the USA

Legal Company Name: Binatone North America
Address: 11550 North Meridian Street, Suite 525
Carmel, IN 46032
Phone, Fax: 317-313-0581
E-mail address: Mert.Ulusoy@binatoneglobal.com
Contact Person: Mert Ulusoy

FCC and IC regulations FCC Part 15

NOTE: This equipment has been tested and found to comply with the limits for a Class B digital device, pursuant to Part 15 of the Federal Communications Commission (FCC) rules. These limits are designed to provide reasonable protection against harmful interference in a

residential installation. This equipment generates, uses and can radiate radio frequency energy and, if not installed and used in accordance with the instructions, may cause harmful interference to radio communications. However, there is no guarantee that interference will not occur in a particular installation. If this equipment does cause harmful interference to radio or television reception, which can be determined by turning the equipment off and on, the user is encouraged to try to correct the interference by one or more of the following measures:

- Reorient or relocate the receiving antenna.
 - Increase the separation between the equipment and receiver.
 - Connect the equipment into an outlet on a circuit different from that to which the receiver is connected.
 - Consult the dealer or an experienced radio/TV technician for help.
- Changes or modifications to this equipment not expressly approved by the party responsible for compliance could void the user's authority to operate the equipment.

This device complies with Part 15 of the FCC rules. Operation is subject to the following two conditions: (1) this device may not cause harmful interference, and (2) this device must accept any interference received, including interference that may cause undesired operation.

Caution: To maintain compliance with the FCC's RF exposure guideline, place the base unit at least 20 cm from nearby persons. To ensure safety of users, the FCC has established criteria for the amount of radio frequency energy that can be safely absorbed by a user or bystander according to the intended usage of the product. This product has been tested and found to comply with the FCC criteria.

This Class B digital apparatus complies with Canadian ICES-003.
CAN ICES-3(B)/NMB-3(B)

This equipment has been certified to comply with ETL US/Canada safety standard in accordance with UL 998 and Canadian National Standard, CSA C22.2 No. 104-11, (Bi-National Standard, same as UL 998).

WARNING

Changes or modifications, to this equipment not expressly approved by the party responsible for compliance could void the user's authority to operate the equipment.

The socket-outlet shall be installed near the equipment and shall be easily accessible.

Industry Canada

This device complies with Industry Canada licence-exempt RSS

standard(s): Operation is subject to the following Two conditions:(1) this device may not cause interference, and (2) this device must accept any interference, including interference that may cause undesired operation of the device.

The term "IC: " before the certification/registration number only signifies that the Industry Canada technical specifications were met. This product meets the applicable Industry Canada technical specifications.

Le présent appareil est conforme aux CNR d'Industrie Canada applicables aux appareils radio exempts de licence. L'exploitation est autorisée aux deux conditions suivantes : (1) l'appareil ne doit pas produire de brouillage, et (2) l'utilisateur de l'appareil doit accepter tout brouillage radioélectrique subi, même si le brouillage est susceptible d'en compromettre le fonctionnement.

11. Technical Specifications

Wi-Fi	2.4GHz
RF Power	10 dBm max
Standby power consumption	less than 0.5 W
Operating Temperature	41°F -104°F (5 °C - 40°C)
Rated Voltage/Frequency	AC120V / 60Hz
Power	Hi-speed 45W Me-speed 37W Lo-speed 25W
Air Quality Indicator	3 colors LED shows air quality • Blue LED = good • Yellow LED = fair • Red LED = bad
Speed Button	Hi-Mid-Low (White light) Auto (Green light)
UVC (Ultraviolet C)	3W – 253.7nm, hot cathode UVC bulb To help kill airborne bacteria, viruses and germs.

Activated Carbon Filter and True HEPA Filter Yes -replaceable

Noise Low \leq 40 dB; Mid \leq 50 dB; High \leq 60 dB

CADR 60CFM
