



motorola



User's Guide

Wearable Smart Device with HD Camera and Wi-Fi® Internet Viewing

Model: SMARTCOLLAR5000

The features described in this User's Guide are subject to modifications without prior notice.



motorola



User's Guide

Wearable Smart Device with HD Camera and Wi-Fi® Internet Viewing

Model: SMARTCOLLAR5000

The features described in this User's Guide are subject to modifications without prior notice.

Welcome...

to your new Motorola Pet Monitor!

Thank you for purchasing the Motorola Pet Monitor. Integrated with a 720p wide-angle camera and connects via Wi-Fi® & mobile network, the Pet Camera streams video of what your dog is doing to your smart device, allowing you to see the world through your dog's eyes.

Please retain your original dated sales receipt for your records. For warranty service of your Motorola product, you will need to provide a copy of your dated sales receipt to confirm warranty status. Registration is not required for warranty coverage.

For product related questions, please call:

US and Canada 1-888-331-3383

Email: support@motorolamonitors.com

This User Guide provides you with all the information you need to get the most from the product and is accurate at the time it was completed. As part of our ongoing effort to improve our products, features and on-screen displays may change from time to time. We recommend you to visit our website www.motorolamonitors.com to get the latest User Guide.

Before using this product:

- Visit our website www.motorolamonitors.com to get the latest User Guide.
- Read and follow the instructions in the User Guide along with the Safety Instructions from pages 6 - 8.
- Upgrade the product's app and firmware (see page 34).

Got everything?

- 1 x Pet Camera (with integrated battery) - Best Fits Pets Over 15 lbs.
- 1 x Leatherette Collar Strap for the Pet Camera
- 1 x Power Adapter for the Pet Camera
- 1 x Quick Start Guide
- 1 x User Guide

Overview of the Pet Camera

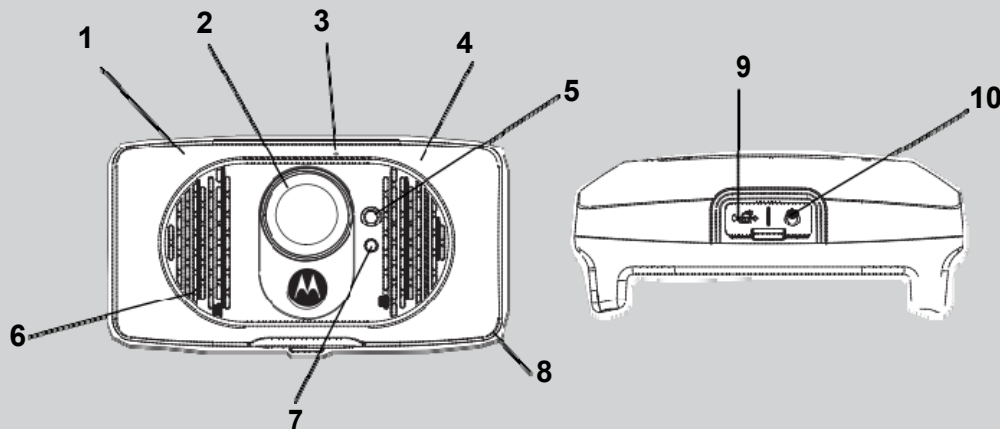

- 1. GPS Antenna**
Tracking - locate the dog's position
GeoFencing - notify you when the dog leaves the defined boundary
- 2. Wide angle camera**
Videostreaming - see what your dog sees
Take pictures
Record videos
- 3. Microphone/G-Sensor**
Detect environmental sound.
G-sensor discriminates your dog's bark from other external noise.
- 4. Wi-Fi®**
Stay in touch with the dog
Stream what the dog sees
Activate local recording
Transmit voice wirelessly
- 5. White LED Light** See what the dogs sees in dark places and at night
- 6. Speaker**
Two way communication
- 7. Status Indicator LED** Lights up in solid green when it is powered on. Lights up in solid red when charging. Blinks in green when it is connected to a smart device.
- 8. Integrated Memory**
Local recording in 720p (HD)
- 9. Micro USB Charging Socket** (with waterproof cover)
- 10. Power On/Off button** (with waterproof cover) 

Behavior of the Status Indicator LED

1. Visible white light - Flash;
2. Solid Green - When powering the device ON and OFF;
3. Solid Red - Charging when the device is switched ON;
4. Solid Orange - Charging when the device is switched OFF;
5. Blue - Switching to Wi-Fi® Direct Mode.

How the Pet Monitor works

The Wi-Fi® and mobile network enabled Pet Camera is integrated with a wide-angle 720p resolution camera, GPS, bark sensor, speaker and more. It offers a quick and easy way for you to track the location of your dog, see what they're doing and receive notifications when they are barking. The Pet Camera streams video and sends alerts to your smart device through an App called "Hubble".

Important guidelines when using the Pet Monitor

- Do not make your dog wear the Pet Camera for more than 12 hours continuously to avoid skin irritation.
- Do not connect a leash to the Pet Camera.
- When connecting a separate collar for the leash, make sure that it does not add pressure on the Pet Camera.
- Check the contact area on your dog's neck for signs of irritation. If there is a rash or sore, discontinue use until the skin is completely healed. See a veterinarian if the condition persists.
- Use of other 2.4 GHz products, such as other wireless networks, Bluetooth® systems or microwave ovens may cause interference with this product. Keep the Pet Camera away from these types of products, or turn them OFF if they appear to be causing interference.
- Always ensure that you have a good Wi-Fi® or mobile connection available.



Table of contents

1. Safety Instructions	6
2. System Requirements	7
3. Basic Setup	8
3.1 Charge the Pet Camera	8
3.2 Attach the Adjustable Strap to the Pet Camera	8
3.3 Fit the Pet Camera on your Dog's Neck	9
3.4 Power On/Off the Pet Camera	10
4. Connecting Devices	11
4.1 User Account and Camera Setup on Android™ Devices	12
4.2 Home Screen of Hubble App on Android Devices	16
4.3 User Account and Camera Setup: Working with iPhone®/iPad®	17
4.4 Home Screen of Hubble App on iOS Devices	21
5. Overview of the features in Hubble App	22
5.1 Modes of operation	22
5.2 Wi-Fi® Local Mode	24
5.3 Wi-Fi® Direct Mode	26
5.4 Mobile Connection Mode	28
5.5 Camera Settings	30
5.6 Account Settings	32
5.7 Add another Pet Camera to your Hubble Account	33
5.8 Reset or remove a Pet Camera from your Hubble Account	33
6. App and Firmware Upgrades	34
6.1 App Upgrade	34
6.2 Firmware Upgrade	34
7. Working with PC/Notebook	35
8. Disposal of the Device (Environment)	36
9. Cleaning and Care	37
10. Help	38
11. Troubleshooting	39
12. General Information	46
13. Technical Specifications	51

1. Safety Instructions



WARNING:

As with any electrical device, supervision of your pet's usage should be exercised until your pet is acclimated to the product. If your pet is prone to chewing, we strongly recommend that you keep this and all other electrical devices out of its reach.

RISK OF SKIN DAMAGE

- Determine a proper fit of the Pet Camera on your dog's neck. If worn for too long or the fit is too tight, it may cause skin damage.
- Check your dog's neck area daily for signs of skin irritation.
- Discontinue use immediately if a rash or sore is found on the neck area.
- AVOID wearing for more than 12 continuous hours a day.
- Clean your dog's neck area and the Pet Camera with a soft damp cloth weekly.

WARNING This Pet Monitor is compliant with all relevant electromagnetic field standards and is, when handled as described in the User's Guide, safe to use. Therefore, always read the instructions in this User's Guide carefully before using the product.

- This product is not a toy. Do not allow children to play with it.
- This product is not a substitute for responsible supervision of your dog.
- Test this product and all its functions so that you are familiar with it prior to actual use.
- Only use the Power Adapter provided.
- Do not use other power adapters as this may damage the device.
- Never use extension cords with Power Adapters.
- Do not touch the plug contacts with sharp or metal objects.
- Keep this User's Guide for future reference.

2. System Requirements

Web Portal

- Windows® 7
- Mac OS® 10.7
- Chrome™ 24
- Internet Explorer® 9
- Safari®6
- Java™ 7
- Firefox® 18.0
- Adobe® Flash® Player 15.0

Android™ System

- Version 4.2 or above

iPhone®/iPad® iOS

- Version 7.0 or above

High Speed (Wi-Fi®) Internet

- At least 0.6 Mbps upload bandwidth per Pet Monitor (you can test your internet speed on this site: <http://www.speedtest.net>)

3. Basic Setup

3.1 Charge the Pet Camera

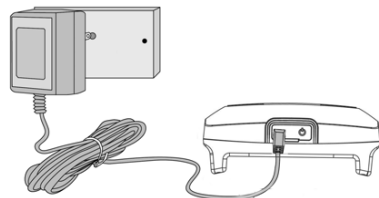

1. Connect the power adapter to an electrical outlet and insert the plug into the micro USB socket on the Pet Camera. Only use the supplied power adapter (5V DC / 1000mA) with the Micro USB plug.
2. The status indicator LED lights up solid red, which indicates that it is charging.

NOTE

Only use the enclosed power adapter (5V DC / 1000mA). The battery pack will take approximately 6 hours to charge. The average battery life is up to 2 weeks, depending on how often you use it. The status indicator LED blinks in red when battery is low. To conserve battery life, press and hold the **POWER KEY** to switch off the Pet Camera when it is not in use.

3.2 Attach the Adjustable Strap to the Pet Camera

1. Set the Pet Camera facing down.
2. With the front side of the buckle facing down, thread the strap through the first slot, moving it towards the second slot.

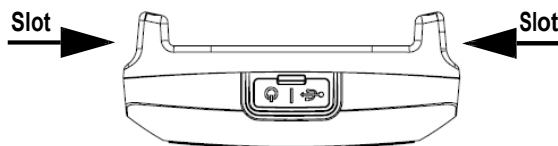

3. Continue to thread through the second slot.

3.3 Fit the Pet Camera on your Dog's Neck

1. Have your dog stand in a balanced position on a flat, even surface.
2. Put the strap over your dog's neck, centering the Pet Camera underneath its neck and making sure that the Motorola logo is upright facing you.
3. String the end of the strap through the strap buckle.
4. Pull the end of the strap until the desired level of tightness is reached and push the retainer bar through the nearest strap hole, then insert the strap through the remaining strap buckle to secure it.
5. Check to ensure that the Pet Camera is in the center underneath the neck of your dog.

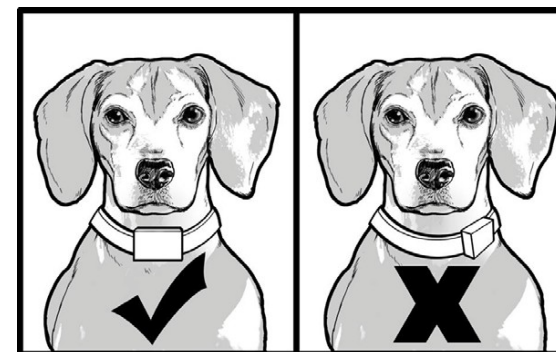
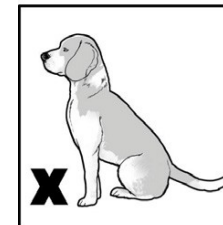
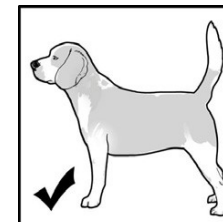

6. Check the fit again after your dog has worn the Pet Camera for several minutes or as your dog gets more comfortable with it.

NOTE The Pet Camera should fit snugly on your dog's neck such that you can only fit two fingers underneath it. It should not be able to rotate around the neck.

3.4 Power On/Off the Pet Camera To power on the Pet Camera, press and hold the **POWER KEY**  for about 3 seconds. The LED lights up in solid green and a melody is played.

To power off the Pet Camera, press and hold the **POWER KEY**  for at least 3 seconds until a melody is played. The LED lights up in solid green before it goes off.

4. Connecting Devices

How does it work?

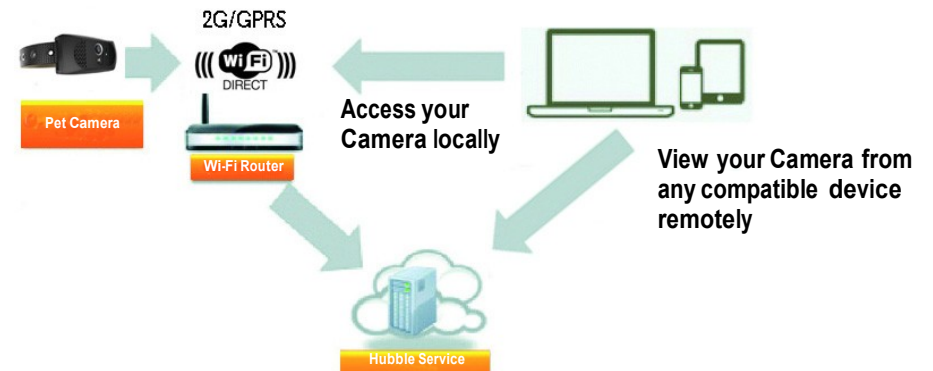

When a user tries to access the Camera, the Hubble server will authenticate the user's identity before it grants access to the Camera.

Important

Make sure that the battery level is more than 70% or the power adapter is plugged in before starting installation.

Setup

- Connect the power adapter to an electrical outlet and insert the plug into the micro USB socket on the Pet Camera.
- Press and hold the **POWER KEY**  for about 3 seconds to switch it on. When switched on, the LED lights up in solid green and a message indicating that the device is ready for connection is played.
- The Pet Camera must be within range of the Wi-Fi[®] router with which you want to connect. Make sure that you have the password of the router for the setup process.

Note You can only setup via a compatible smart device, such as smartphone or tablet, and not via a PC.

4.1 User Account and Camera Setup on Android™ Devices

What you need

- Pet Camera
- Pet Camera Power Adapter
- Device with Android™ system version 4.0 and above

4.1.1 Power On the Pet Camera

- Connect the power adapter to an electrical outlet and insert the plug into the micro USB socket on the Pet Camera.
- Press and hold the POWER KEY  for about 3 seconds to switch it on. When switched on, the LED lights up in solid green and a message indicating that the device is ready for connection is played.

4.1.2 Download Hubble for Motorola Petcam App

- Go to Google Play™ Store to search for "Hubble for Motorola Petcam".
- Download "Hubble for Motorola Petcam" App from Google Play™ Store and install it on your Android™ device

4.1.3 Run Hubble for Motorola Petcam app on Android™ device

- Ensure that your Android™ device is connected to your Wi-Fi® router.
- Run "Hubble for Motorola Petcam" App, tap Get Started, enter your account information, read through the Terms of Service, then select "I agree to the Terms of Use" before you tap Create account. (Picture A1)

Note If you already have a Hubble App account, please select Already have an Account? to go to the next step.

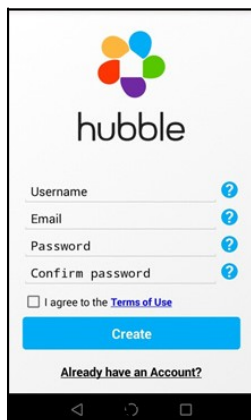

4.1.4 Add Camera to your account

- Tap  on the top right corner of the screen to add camera. (Picture A2)

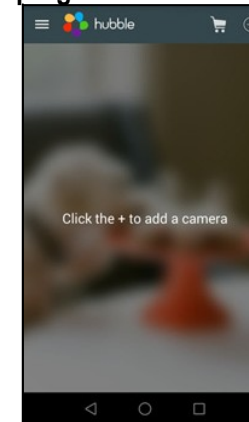

A2

- The following setup instructions will appear on the screen. (Picture A3)

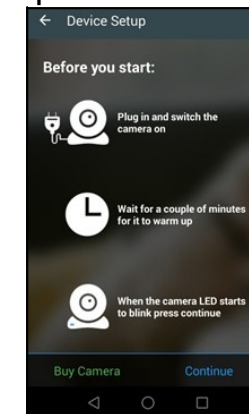

A3

- Tap Continue.

- The following setup instructions will appear on the screen. (Picture A4)

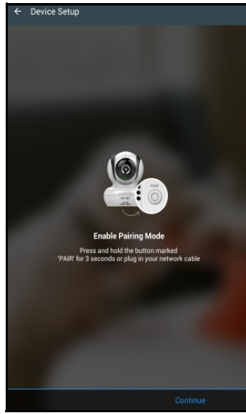

A4

- Tap Continue.
- The App will automatically search for the Pet Camera. (Picture A5)
- Tap to select the Pet Camera.

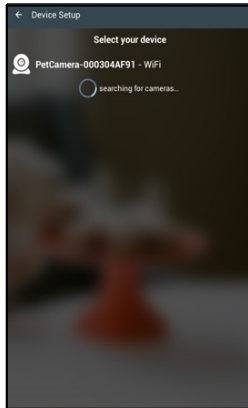

A5

- Select your Wi-Fi® Network, enter your password and then tap Connect. (Pictures A6, A7)

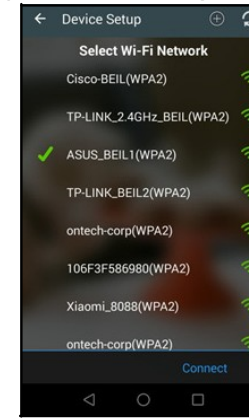

A6

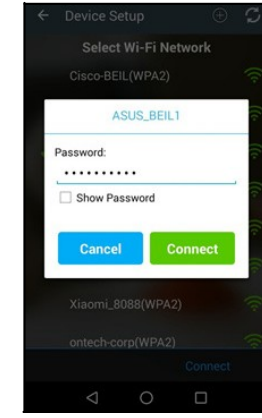

A7

- It will take a few minutes for the Pet Camera to connect to the Wi-Fi® network before showing the connection status. (Picture A8, A9)
- If connection fails, please tap Retry and repeat the steps starting from 4.1.4.

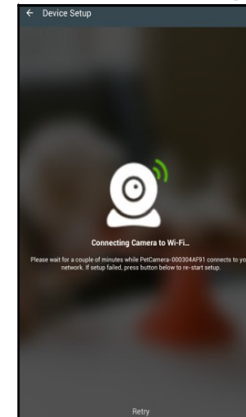

A8

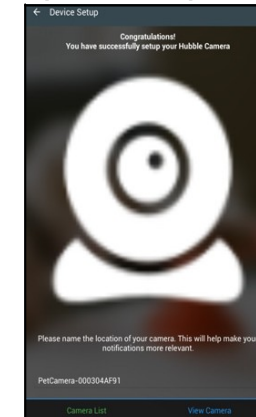

A9

- Tap View Camera to go into live streaming mode.

4.2 Home Screen of Hubble App on Android Devices

Tap to access Camera list or enter Account Settings.

Tap to enter live streaming mode.

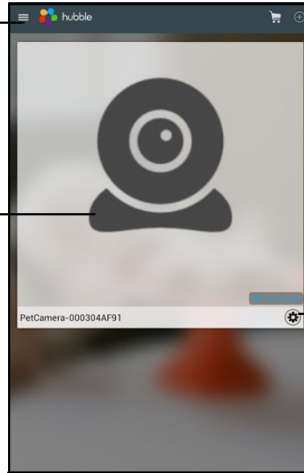

Tap to enter Camera Settings.

4.3 User Account and Camera Setup: Working with iPhone®/iPad®

What you need

- Baby Unit (Camera)
- Power adapter for the Camera
- iPhone® / iPad® with iOS version 7.0 and above

4.3.1 Power On the Pet Camera

- Connect the power adapter to an electrical outlet and insert the plug into the micro USB socket on the Pet Camera.
- Press and hold the **POWER KEY**  for about 3 seconds to switch it on. When switched on, the LED lights up in solid green and a message indicating that the device is ready for connection is played.

4.3.2 Download Hubble for Motorola Petcam App

- Go to App Store to search for "Hubble for Motorola Petcam".
- Download "Hubble for Motorola Petcam" App and install it on your iPhone®/iPad®.

4.3.3 Run Hubble App on your iPhone®/iPad®

- Ensure that your iPhone®/iPad® is connected to your Wi-Fi® Router.
- Run the "Hubble for Motorola Petcam" App, enter your account information, read through the Terms of Service, and then select "I agree to the Terms of Service" before you tap Create. (Picture i1)

Note: If you already have a Hubble App account, please select Already have an Account? to go to the next step (Picture i1).

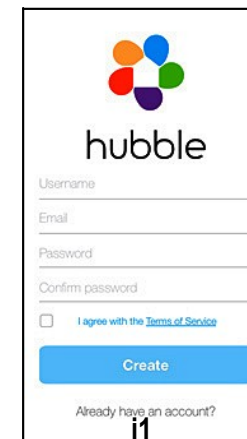

4.3.4 Add the Camera to your account

- Tap on the top right corner of the screen to add camera. (Picture i2).

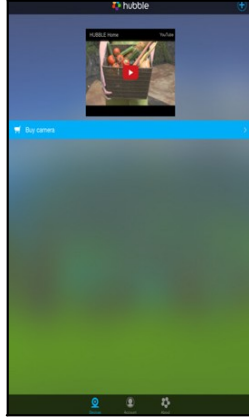

i2

- The following setup instructions will appear on the screen. (Picture i3)

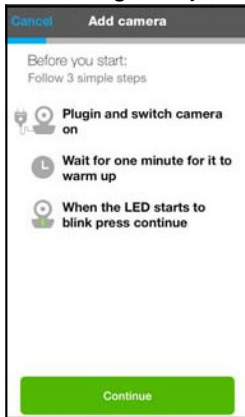

i3

- Tap Continue.

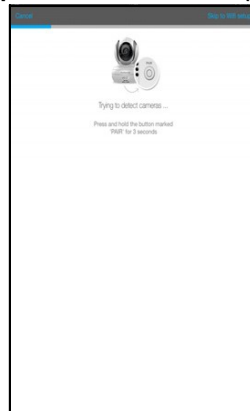

i4

- The following setup instructions will appear on the screen.



i4



i5

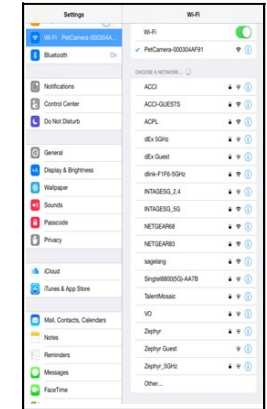

i6

- Press the Home Key on iPhone®/iPad® and go to Settings > Wi-Fi menu (Pictures i4, i5).
- Select your Pet Camera from the list of networks (Picture i6).
- Return to the Hubble app to resume setup.
- Name the location of your Pet Camera and tap Continue. (Pictures i7, i8)

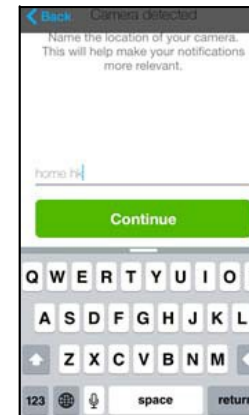

i7



i8

- Select your Wi-Fi® network and tap Continue. (Picture i9)

- Enter your Wi-Fi® password and tap Next. (Picture i10)

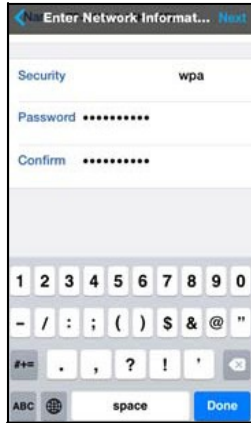

i10

- It will take a few minutes for the Pet Camera to connect to the Wi-Fi® network before showing the connection status (Picture i11, i12).

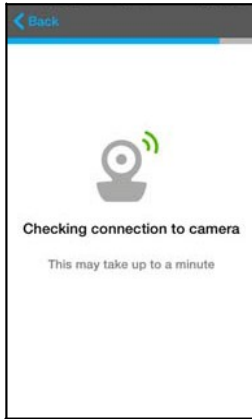

i11

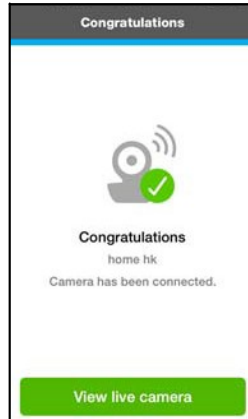

i12

- If connection fails, please tap Retry and repeat the steps starting from 4.3.4.
- Tap View Live Camera to go into live streaming mode.

4.4 Home Screen of Hubble App on iOS Devices

Tap to enter live streaming mode.

Tap to enter Camera Settings.

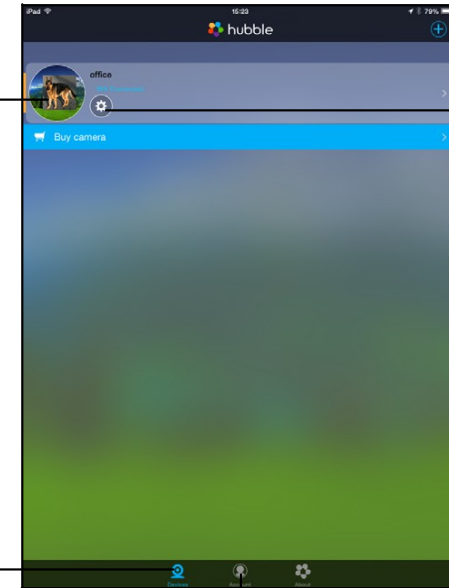

Tap to access Camera list.

Tap to enter Account Settings.

5. Overview of the features in Hubble App

5.1 Modes of operation

The Pet Camera supports 3 modes of operation:

- Wi-Fi® Local (smart device connects to Pet Camera via local Wi-Fi® Access Point)
- Wi-Fi® Direct (smart device connects directly to Pet Camera via Wi-Fi®)
- Mobile (smart device connects to Pet Camera via 2G/GPRS)

	Wi-Fi® Local	Wi-Fi® Direct	Mobile [^]
<i>Live streaming</i>	√	√	x
<i>Record video</i>	√	√	√
<i>Take pictures</i>	√	√	√
<i>Night vision</i>	√	√	
<i>Download and Share pictures & video*</i>	√	√	√
<i>2-way communication</i>	√	√	x
<i>Playback pre-recorded reward or warning messages</i>	√	√	√
<i>Location view (mobile, GPS)</i>	x	√	√
<i>Location tracking (mobile, GPS)</i>	x	√	√

<i>Geo Fencing (GPS)</i>	x	√	√
<i>Bark Detection</i>	n/a	n/a	n/a

Notes

*Once a video is downloaded, it will be removed from the Pet Camera.

[^]You will receive a notification when the battery level falls below 20%. The Pet Monitor will go into power saving mode. All functions will be deactivated except mobile connection.

[^]You must have a 2G network subscription plan and be within 2G coverage areas.

Send Pre-recorded Reward or Warning Message (see Section 5.2)

You can record reward or warning messages and send them to your dog through the Pet Collar when the pet behaves or misbehaves.

Two-way Communication (see Section 5.2)

Listen and speak back to your dog through the Pet Collar, issue commands or offer a soothing voice for your agitated dog.

Geo Fencing (see Fence Settings in Section 5.3)



Set up virtual boundary and receive notifications when your dog ventures out of the set boundary.

Location Tracking (see Bark and GPS Settings in Section 5.3)







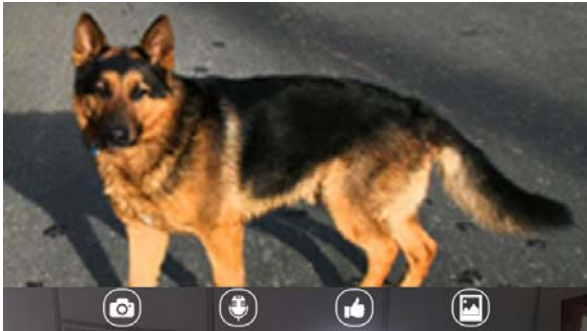

Find the dog's current location via GPS.

Note Location tracking will be based on the mobile network first (with a tolerance of around 0.6miles), then by GPS satellite (with a tolerance of around 30 feet).

5.2 Wi-Fi® Local Mode





- Run Hubble for Motorola Petcam App on your smart device and log into your Hubble account.
- If you have more than 1 Pet Camera in your account: For iOS Devices, tap Devices  to select a camera from the camera list
For Android™ Devices, tap  > Cameras  to select a camera from the camera list
- Tap on the video image to show the options available.







	Take Photo/ Record Video/ Activate Night Vision	Tap to take a photo  , record a video from  your Pet Camera or activate night vision  (the white LED light on the Pet Camera will light up).
	Two-way communication	Tap to activate the function. Tap on the round button  once to speak through the Pet Camera. Toggle the button again to listen to the audio feedback from the Pet Camera.
	Send Reward/ Warning Messages	Tap to send a pre-recorded reward  or warning  message to your dog through the Pet Camera.



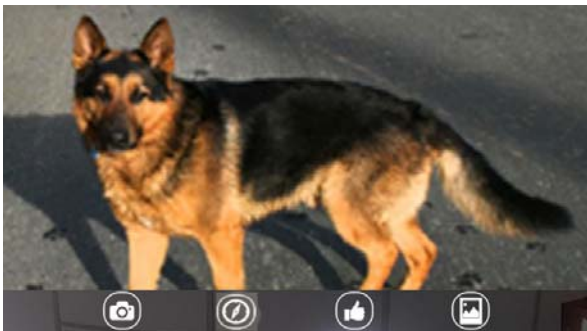





	Photo/Video Gallery	Tap to enter photo or video gallery where you can download, share or delete the photos you have taken and videos you have recorded on your Pet Camera.
---	--------------------------------	--

5.3 Wi-Fi® Direct Mode





- Run Hubble for Motorola Petcam App on your smart device and log into your Hubble account.
- If you have more than 1 Pet Camera in your account: For iOS Devices, tap Devices  to select a camera from the camera list For Android™ Devices, tap  > Cameras  to select a camera from the camera list
- Tap on Settings icon  to enter Camera Settings.
- Tap Wifi Direct Mode to connect to your Pet Camera via Wi-Fi® Direct. It takes about 1 minute to establish a connection and you will hear a voice prompt notifying you that the connection has been established.
- Tap View Camera at the bottom of the screen and then tap on the video image to show the options available.
- Tap EXIT WIFI DIRECT and then tap OK to exit Wi-Fi® Direct mode.









	Take Photo/ Record Video/ Activate Night Vision	Tap to take a photo  , record a video from your Pet Camera or activate night vision  (the white LED light on the Pet Camera will light up).
--	--	---

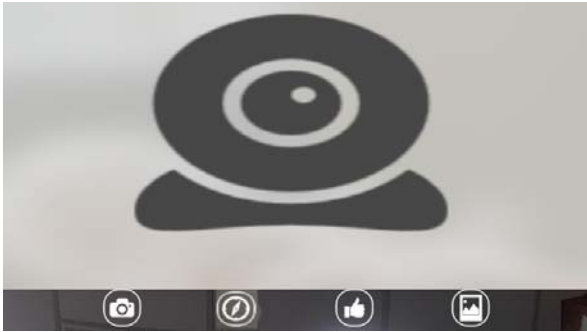



	Location Tracking and Geo Fencing	Tap  > Track to track the location of your pet. Your pet's location is identified by a blue dot. Note that location tracking will be based on the mobile network first (with a tolerance of around 0.6miles), then by GPS satellite (with a tolerance of around 30 feet). Tap  to set the radius for Geo Fencing.
	Two-way communication and Send Reward/ Warning Messages	Tap on the round button  once to speak through the Pet Camera. Toggle the button again to listen to the audio feedback from the Pet Camera. Tap to send a pre-recorded reward  or warning  message to your dog through the Pet Camera.
	Photo/Video Gallery	Tap to enter photo or video gallery where you can download, share or delete the photos you have taken and videos you have recorded on your Pet Camera.

5.4 Mobile Connection Mode





- Run Hubble for Motorola Petcam App on your smart device and log into your Hubble account.
- If you have more than 1 Pet Camera in your account: For iOS Devices, tap  to select a camera from the camera list For Android™ Devices, tap  > Cameras  to select a camera from the camera list
- If your smart device is not connected to any local Wi-Fi® network, it will be connected by mobile network automatically.
- Tap  in the center of the screen to show the options available.



	Take Photo/ Record Video	Tap to take a photo  , record a video  from your Pet Camera.
	Location Tracking and Geo Fencing	Tap  > Track to activate location tracking. Your pet's location is identified by a blue dot. Note that location tracking will be based on the mobile network first (with a tolerance of around 0.6miles), then by GPS satellite (with a tolerance of around 30 feet). Tap  to set the radius for Geo Fencing.

	Send Reward/ Warning Messages	Tap to send a pre-recorded reward  or warning  message to your dog through the Pet Camera.
	Photo/Video Gallery	Tap to enter photo or video gallery where you can download, share or delete the photos you have taken and videos you have recorded on your Pet Camera.

5.5 Camera Settings

- Run Hubble for Motorola Petcam App on your smart device and log into your Hubble account.
- If you have more than 1 Pet Camera in your account: For iOS Devices, tap Devices  to select a camera from the camera list For Android™ Devices, tap  > Cameras  to select a camera from the camera list
- Tap on Settings icon  to enter Camera Settings.
- Tap Save after you have modified the settings.

General Settings	<ul style="list-style-type: none"> • Clock: 12h or 24h • Time Out (Recording): 1m - 5m The Pet Camera will stop recording after the set time out duration. • Units: Meter or Feet • Email
Bark and GPS Settings	<ul style="list-style-type: none"> • Bark notification: On or Off (<i>currently not available</i>) • Bark Sensitivity: Low, Medium or High (<i>currently not available</i>) • Recorded Tone: Record Reward Tone and Warning Tone • GPS Notification: On or Off • GPS Mode: Tap to select Battery Saving or Tracking

Fencing Settings	<p>Set up virtual boundary and receive notifications when your dog ventures out of the set boundary.</p> <ul style="list-style-type: none"> • Fence Notification: On or Off • Fence Sensitivity: Low, Medium or High • Narrow: 50m to 100m • Medium: 101m to 200m • Large: 301m to 500m • Tolerance: 5m to 20m
Camera Details	<ul style="list-style-type: none"> • Change camera name • Change snapshot of the Pet Camera in your Hubble account by taking a photo or take a snapshot of the camera's image.
Wifi Direct Mode	Tap to switch connection mode to Wifi Direct.
Memory	Check memory available on the Pet Camera.
Battery Level	Check battery level on the Pet Camera.
Updates	Shows the status of the software application.
Logout	Tap to logout of Hubble account.

5.6 Account Settings

- Run Hubble for Motorola Petcam App on your smart device and log into your Hubble account.
- For iOS Devices, tap Account 

For Android™ Devices, tap  > Account 

- You can modify the following settings:



Profile	Username: shows current username Email: shows current user email Temperature: choose Celsius or Fahrenheit Password: change Password Debug Screen: Go to debug screen Log out:
Subscription	Shows your subscription plan.
Notifications	Do Not Disturb: disabled, or from 1 minute to 180 minutes Notification frequency: immediately, 1 minute to 60 minutes or disabled. Notify me by sound: check or uncheck the checkbox to enable or disable. Notify me by vibration: check or uncheck the checkbox to enable or disable Notify me when on a call: check or uncheck the checkbox to enable or disable
Remote Connection Setting	Remote View Timeout: check or uncheck the checkbox to enable or disable
About Hubble	View Terms and Conditions Shows the current App version number.

5.7 Add another Pet Camera to your Hubble Account

- In the home screen of the Hubble app, tap  to add another Pet Camera to your account (follow 4.1.4 for Android devices and 4.3.4 for iPhone/iPad devices)
- You can add up to 4 Pet Monitors to one account.

5.8 Reset or remove a Pet Camera from your Hubble Account

If your Pet Camera is moved from one router (e.g. home) to another (e.g. office) or you have setup issues, then the Pet Camera must be reset.

- Go to Camera Settings  menu of the Pet Camera you wish to remove (see Section 5.3).
- Tap the trash bin icon  on the top right corner of the screen.
- Tap Yes to remove the Pet Camera.
- The Pet Camera will be de-registered from your Hubble Account and all settings will be reset to default.

6. App and Firmware Upgrades

6.1 App Upgrade

You can find the latest version of Hubble App by visiting your mobile device's app store (e.g.: iTunes App Store, Google Play™). From there, you can see what's new with the app and install the latest version.

Occasionally, Hubble Server will also send you a notification that a latest version of the app is available. While some of the upgrades simply keep your system running efficiently, and some are critical to system functionality. We strongly recommend that you complete the upgrade as soon as possible. Software Upgrade will only be performed in Wi-Fi® mode.

6.2 Firmware Upgrade

Firmware updates will be sent to the Pet Camera over Wi-Fi® or GPRS network.

7. Working with PC/Notebook

- Go to: <http://www.hubbleconnected.com/motorola/login/>
- Enter your User Name and Password and then click Login if you have already created an account.
- Click the Camera list paired in your account via Android™ device or iPhone®/iPad®. The video captured by the Pet Camera will appear on the screen. You can easily stay connected with your dog with live video streaming.
- You can also change the settings by following the Menu instructions on the website.

8. Disposal of the Device (Environment)

At the end of the product life cycle, you should not dispose of this product with normal household waste. Take this product to a collection point for the recycling of electrical and electronic equipment. The symbol on the product, user's guide and/or box indicates this. 

Some of the product materials can be reused if you take them to a recycling point. By reusing some parts or raw materials from used products you make an important contribution to the protection of the environment.

Please contact your local authorities in case you need more information on the collection points in your area.

Dispose of the battery pack in an environmentally-friendly manner according to your local regulations.

9. Cleaning and Care

- Check your dog's neck area for irritation and wash neck weekly.
- Every effort has been made to ensure high standards of reliability of your Pet Monitor. However, if something does go wrong, please do not try to repair it yourself – contact Customer Service for assistance.

10. Help

Noise interference

- To avoid background noise or echoes, ensure that there is enough distance between your device and the Pet Monitor.
- Use of other 2.4 GHz products, such as Bluetooth® systems or microwave ovens, may cause interference with this product. Keep the Pet Monitor at least 5 feet (1.5 meters) away from these types of products, or turn them off if they appear to be causing interference.

Lost connection

- Check your Wi-Fi® settings. If necessary, reconnect your Wi-Fi®. Ensure that the Pet Monitor is switched ON. Wait a few minutes to connect to the Wi-Fi® network.

If you forgot your password If you do not remember your password, tap *Forgot Password* to submit your e-mail address. A new password will be sent to your e-mail address immediately.

11. Troubleshooting

Category	Problem Description / Error	Solution
Account	I am not able to login even after registration.	Please check your user name and password.
Account	I receive an error message saying: "Email ID is not registered".	Please ensure that you have registered an account with us. Tap Create Account to create an account.
Account	What do I do if I forget my password?	Click on the "Forgot Password" link on the website http://www.hubbleconnected.com/motorola/login/ OR on your Android™ or iOS application. An email will be sent to your registered email address.
Account	I did not receive a new password although I have used the "Forgot Password" option.	<ol style="list-style-type: none"> 1. The e-mail might have been sent to your Junk Mail Folder. Please check your Junk Mail Folder. 2. There might be a delay in getting your e-mail. Please wait for a few minutes and refresh your email account.
Camera	When I try to view the Pet Monitor, I get a prompt for Pet Camera firmware upgrade. What should I do?	Please upgrade your firmware. This takes around 5 minutes. We push upgrades from time to time to improve Pet Camera features.

Connectivity Issues	<p>I get a message: We are having problems accessing your Camera. This could be due to the lack of an internet connection. Please wait and try again later.</p>	<ol style="list-style-type: none"> 1. Please try again in a few minutes. This could be due to an issue with your internet connection. 2. If the problem persists, please restart your Pet Camera to check if this fixes the problem. 3. Please restart your Wireless Router. 4. Rebooting your smart phone/ smart device could also resolve the problem.
Connectivity Issues	<p>I am not able to access my Pet Camera.</p>	<p>Please check if the Pet Camera is within Wi-Fi® range. If the LED on your Pet Camera is flashing slowly, please try to move the Pet Camera closer to the router for better Wi-Fi® connectivity and try again.</p>
Connectivity Issues	<p>Even though I am accessing my Pet Camera from the same Wi-Fi® network, my Pet Camera is still shown as remote. I can only access it for 5 minutes at a time.</p>	<p>Please check your wireless router settings. For example, there is an option called Wireless Isolation on Buffalo brand routers. Please disable this option.</p>
Connectivity Issues	<p>I found interference caused by my other webcam devices.</p>	<p>Video streaming performance is related to internet bandwidth, especially if you have 2 or more video streaming devices that are working through the same router.</p>

Features	<p>The sound alert setting threshold is not right.</p>	<p>You can adjust Sound Sensitivity to trigger notifications under the Pet Camera Settings menu. (See Section 5.3)</p>
Features	<p>How many users can access the Pet Camera at one time?</p>	<p>If you are accessing in local mode, two users are supported. If there are more than two users, all streaming will go through the remote server. This allows for unlimited user access to a single Pet Camera at one time.</p>
General	<p>What are the supported browsers for access from my PC/ Mac®?</p>	<p>We recommend using Google Chrome™ 24 or above. However the following browsers are also supported: Internet Explorer 9.0® or above (for PC), Safari® 6.0 or above (for Mac) or Firefox® 18.0 or above (both PC or Mac).</p>
General	<p>Which platforms are supported for access to my Pet Camera?</p>	<p>Minimum requirement: Windows 7* *Java browser plug-in needed Mac OS version 10.7 Chrome™ version 24 Internet Explorer version 9 Safari version 6 Java™ version 7 Firefox version 18.0 Adobe Flash Player 15.0 Android™ 4.2 iPhone /iPad iOS version 7.0</p>

General	I do not hear sound when I am accessing a remote Pet Camera.	You can tap on the Speaker icon in the video stream screen to hear audio. By default, the audio is OFF when you are accessing a remote Pet Camera.
General	What is the meaning of "Local Camera" and "Remote Camera"?	When you are accessing your Pet Camera from the same wireless network (Home) in which it is configured, it is a local Camera. When you are accessing your Pet Camera away from your home, it is a Remote Camera. You may be using 3G, 4G or 4G LTE or a Wi-Fi® connection outside of your home.

General	What is the significance of LED flashing?	<p>A flashing LED indicates the following status:</p> <p>Slow flashing: 1. Your Pet Camera is in setup mode. You can add the Pet Camera to your account in this mode. Out of the box, the Pet Camera is in Setup mode. To reset to Setup mode, see Section 5.8.</p> <p>Slow flashing: 2. The Pet Camera is either connecting to the router or has lost the link to the router. Please ensure that the Pet Camera is in the Wi-Fi® signal range.</p> <p>LED is stable: The Pet Camera is connected to the Wi-Fi® network.</p>
---------	---	---

General	How do I download the Application for Android™ and iOS devices?	<p>Android™:</p> <ul style="list-style-type: none"> - Open the <i>Google Play Store</i> on your Android™ device - Select Search - Type "Hubble for Motorola Petcam" - The results will show the Hubble for Motorola Petcam App - Select to install it <p>iOS Device:</p> <ul style="list-style-type: none"> - Open the <i>App Store</i>SM - Select Search - Type "Hubble for Motorola Petcam" - The results will show the Hubble for Motorola Petcam App - Select to install it
Setting Up	While I am adding a new Pet Camera to my account, I am not able to find any Pet Camera to add.	If you are trying to add a Pet Camera which has previously been added into your account or another account, you will first have to reset the Pet Camera. To reset the Pet Camera, see Section 5.8.
Setting Up	During setup on devices for Android™ and iOS, I am not able to find my Pet Camera during the last step and the setup fails.	Please reset the Pet Camera to Setup mode and try again. To reset the Pet Camera, see Section 5.8.

Setting up	When the video is cut off, the application attempts to reconnect and this results in lost sound and choppy video.	You will need to turn off the auto lock function on your smart device to ensure continuous video/audio feeding.
Viewing Camera	When I am in "Remote Mode", the video stops after 5 minutes. How do I view it for longer?	<p>When you are accessing your Pet Camera via a network different from your home network (over the internet) your video will time-out after 5 minutes.</p> <p>You can click on the Pet Camera again from the Android™/iOS application to start streaming again.</p> <p>If you are accessing from your web browser, you can press the Reload button to start viewing the video stream from your Pet Camera again.</p>

12. General Information

If your product is not working properly....

1. Read this User's Guide.
2. Contact Customer Service: US
and Canada 1-888-331-3383
Email: support@motorolamonitors.com

Consumer Products and Accessories Limited Warranty Thank you for purchasing this Motorola branded product manufactured under license by Binatone Electronics International LTD ("BINATONE").

What Does this Warranty Cover? Subject to the exclusions contained below, BINATONE warrants that this Motorola branded product ("Product") or certified accessory ("Accessory") sold for use with this product that it manufactured to be free from defects in materials and workmanship under normal consumer usage for the period outlined below. This Warranty is your exclusive warranty and is not transferable.

Who is covered?

This Warranty extends only to the first consumer purchaser, and is not transferable.

What will BINATONE do? BINATONE or its authorised distributor at its option and within a commercially reasonable time, will at no charge repair or replace any Products or Accessories that does not conform to this Warranty. We may use functionally equivalent reconditioned/ refurbished/ pre-owned or new Products, Accessories or parts.

What Other Limitations Are There? ANY IMPLIED WARRANTIES, INCLUDING WITHOUT LIMITATION THE IMPLIED WARRANTIES OF MERCHANTABILITY AND FITNESS FOR A PARTICULAR PURPOSE, SHALL BE LIMITED TO THE DURATION OF THIS LIMITED WARRANTY, OTHERWISE THE REPAIR OR REPLACEMENT PROVIDED UNDER THIS EXPRESS LIMITED WARRANTY IS THE EXCLUSIVE REMEDY OF THE CONSUMER, AND IS PROVIDED IN LIEU OF ALL OTHER WARRANTIES, EXPRESS OR IMPLIED. IN NO EVENT SHALL MOTOROLA OR BINATONE BE LIABLE, WHETHER IN CONTRACT OR TORT (INCLUDING NEGLIGENCE) FOR DAMAGES IN EXCESS OF THE PURCHASE PRICE OF THE PRODUCT OR ACCESSORY, OR FOR ANY INDIRECT, INCIDENTAL, SPECIAL OR CONSEQUENTIAL DAMAGES OF ANY KIND, OR LOSS OF REVENUE OR PROFITS, LOSS OF BUSINESS, LOSS OF INFORMATION OR OTHER FINANCIAL LOSS ARISING OUT OF OR IN CONNECTION WITH THE ABILITY OR INABILITY TO USE THE PRODUCTS OR ACCESSORIES TO THE FULL EXTENT THESE DAMAGES MAY BE DISCLAIMED BY LAW.

Some jurisdictions do not allow the limitation or exclusion of incidental or consequential damages, or limitation on the length of an implied warranty, so the above limitations or exclusions may not apply to you. This Warranty gives you specific legal rights, and you may also have other rights that vary from one jurisdiction to another.

Products Covered	Length of Coverage
Consumer Products	One (1) year from the date of the products original purchase by the first consumer purchaser of the product.
Consumer Accessories	Ninety (90) days from the date of the accessories original purchase by the first consumer purchaser of the product.
Consumer Products and Accessories that are Repaired or Replaced	The balance of the original warranty or for Ninety (90) days from the date returned to the consumer, whichever is longer.

Exclusions

Normal Wear and Tear. Periodic maintenance, repair and replacement of parts due to normal wear and tear are excluded from coverage.

Batteries. Only batteries whose fully charged capacity falls below 80% of their rated capacity and batteries that leak are covered by this Warranty.

Abuse & Misuse. Defects or damage that result from: (a) improper operation, storage, misuse or abuse, accident or neglect, such as physical damage (cracks, scratches, etc.) to the surface of the product resulting from misuse; (b) contact with liquid, water, rain, extreme humidity or heavy perspiration, sand, dirt or the like, extreme heat, or food; (c) use of the Products or Accessories for commercial purposes or subjecting the Product or Accessory to abnormal usage or conditions; or (d) other acts which are not the fault of MOTOROLA or BINATONE, are excluded from coverage.

Use of Non-Motorola branded Products and Accessories. Defects or damage that result from the use of Non-Motorola branded or certified Products or Accessories or other peripheral equipment are excluded from coverage.

Unauthorised Service or Modification. Defects or damages resulting from service, testing, adjustment, installation, maintenance, alteration, or modification in any way by someone other than MOTOROLA, BINATONE or its authorized service centers, are excluded from coverage.

Altered Products. Products or Accessories with (a) serial numbers or date tags that have been removed, altered or obliterated; (b) broken seals or that show evidence of tampering; (c) mismatched board serial numbers; or (d) nonconforming or non-Motorola branded housings, or parts, are excluded from coverage.

Communication Services. Defects, damages, or the failure of Products or Accessories due to any communication service or signal you may subscribe to or use with the Products or Accessories is excluded from coverage.

How to Obtain Warranty Service or Other Information?

To obtain service or information, please call:

US and Canada 1-888-331-3383

Email: support@motorolamonitors.com

You will receive instructions on how to ship the Products or Accessories at your expense and risk, to a BINATONE Authorized Repair Centre.

To obtain service, you must include: (a) the Product or Accessory; (b) the original proof of purchase (receipt) which includes the date, place and seller of the Product; (c) if a warranty card was included in your box, a completed warranty card showing the serial number of the Product; (d) a written description of the problem; and, most importantly; (e) your address and telephone number.

These terms and conditions constitute the complete warranty agreement between you and BINATONE regarding the Products or Accessories purchased by you, and supersede any prior agreement or representations, including representations made in any literature publications or promotional materials issued by BINATONE or representations made by any agent employee or staff of BINATONE, that may have been made in connection with the said purchase.

FCC, ACTA and Industry Canada (IC) regulations

WARNING Changes or modifications to this equipment not expressly approved by the party responsible for compliance could void the user's authority to operate the equipment.

NOTE This equipment has been tested and found to comply with the limits for a Class B digital device, pursuant to Part 15 of the Federal Communications Commission (FCC) rules. These limits are designed to provide reasonable protection against harmful interference in a residential installation. This equipment generates, uses and can radiate radio frequency energy and, if not installed and used in accordance with the instructions, may cause harmful interference to radio communications. However, there is no guarantee that interference will not occur in a particular installation. If this equipment does cause harmful interference to radio or television reception, which can be determined by turning the equipment off and on, the user is encouraged to try to correct the interference by one or more of the following measures:

- Reorient or relocate the receiving antenna.
- Increase the separation between the equipment and receiver.
- Connect the equipment into an outlet on a circuit different from that to which the receiver is connected.
- Consult the dealer or an experienced radio/TV technician for help. This device complies with Part 15 of the FCC rules. Operation is subject to the following two conditions: (1) this device may not cause harmful interference, and (2) this device must accept any interference received, including interference that may cause undesired operation. Privacy of communications may not be ensured when using this device.

To ensure safety of users, the FCC has established criteria for the amount of radio frequency energy that can be safely absorbed by a user or bystander according to the intended usage of the product. This product has been tested and found to comply with the FCC criteria. This Class B digital apparatus complies with Canadian ICES-003. CAN ICES-3(B)/NMB-3(B)

13. Technical Specifications

Wi-Fi®	802.11 b/g/n Image
sensor	Color CMOS 1M Pixels
Lens	f = 2.3mm, F = 2.4
LED	5 colors
Power Adapter	Input: 100-240V AC, 50/60Hz, 300mA Output: 5V DC, 1000mA

To comply with RF exposure requirements, a minimum separation distance of **20cm** must be maintained between the user's body including the antenna.



Manufactured, distributed or sold by Binatone Electronics International LTD., official licensee for this product. MOTOROLA and the Stylized M logo are trademarks or registered trademarks of Motorola Trademark Holdings, LLC. and are used under license. Apple logo and Safari are trademarks of Apple Inc., registered in the U.S. and other countries. App Store is a service mark of Apple Inc. Google Play, Android, and Chrome are trademarks of Google Inc. Wi-Fi is a trademark of the Wi-Fi Alliance. Internet Explorer and Windows are trademarks of the Microsoft group of companies. Firefox is a registered trademark of the Mozilla Foundation. Adobe and Flash are either registered trademarks or trademarks of Adobe Systems Incorporated. Java is a registered trademark of Oracle and/or its affiliates. All other trademarks are the property of their respective owners. © 2015 Motorola Mobility LLC. All rights reserved.