

Bioland®

Blood Glucose Monitor

Model: G-427B



OWNER'S MANUAL

CE 0123

Dear Bioland Blood Glucose Monitoring System Owner:

Thank you for choosing this system!

This manual contains important information you must know about the system.

Please read it thoroughly and carefully.

The system provides No Code function which means that you don't need to calibrate your metermaking it easier for the user to monitor blood glucose at home.

IMPORTANT SAFETY INSTRUCTIONS

The meter and lancing device are for single patient use. Do not share them with anyone including other family member! Do not use on multiple patients!

All parts of the kit are considered biohazardous and can potentially transmit infectious diseases even after you have performed cleaning and disinfection.

Changes or modifications not expressly approved by the party responsible for compliance could void the user's authority to operate the equipment.

This device complies with Part 15 of the FCC Rules. Operation is subject to the following two conditions: (1) this device may not cause harmful interference, and (2) this device must accept any interference received, including interference that may cause undesired operation.

This equipment has been tested and found to comply with the limits for a Class B digital device, pursuant to Part 15 of the FCC Rules. These limits are designed to provide reasonable protection against harmful interference in a residential installation. This equipment generates, uses and can radiate radio frequency energy and, if not installed and used in accordance with the instructions, may cause harmful interference to radio communications. However, there is no guarantee that interference will not occur in a particular installation.

If this equipment does cause harmful interference to radio or television reception, which can be determined by turning the equipment off and on, the user is encouraged to try to correct the interference by one or more of the following measures:

- Reorient or relocate the receiving antenna.
- Increase the separation between the equipment and receiver.
- Connect the equipment into an outlet on a circuit different from that to which the receiver is connected.
- Consult the dealer or an experienced radio/TV technician for help.

READ THIS BEFORE USING

DANGER - Misuse of this electrical device can cause electrocution, burns, fire and other HAZARDS.

Basic safety precautions should always be taken, including all those listed below.

Close supervision is necessary when equipment is used by, on, or near children,

handicapped persons or invalids.

The following basic safety notice should always be taken:

1. Do not place the device in liquid, nor put it where it could fall into liquid.
2. The following basic safety notice should always be taken.
3. Use the device only for the intended use described in this manual.
4. Do not use adjunct which are not supplied by the producer.
5. Do not make the device come into contact with surfaces which are too hot to touch.
6. Do not use the device where aerosol sprays are being used.
7. Do not use the device if it is not working properly, or if it has been damaged.
8. Read all the manual, and practice the test, and then use the product to test your blood glucose. Do all quality control checks as directed and consult with a diabetes expert.

KEEP THESE INSTRUCTION IN A SAFE PLACE

Table of Contents

BEFORE YOUR BEGIN.....	4
INTRODUCTION TO THE SYSTEM.....	4
Intended Use	4
ABOUT ALTERNATIVE SITE TESTING (AST)	5
CONTENTS OF THE KITS.....	6
Blood Glucose Meter.....	7
Meter Screen Display Message	7
Test Strip.....	7
SETTING THE METER AND DELETING THE MEMORY	8
THE TWO MEASURING MODES	11
TESTING WITH BLOOD SAMPLE	11
Overview of the Lancing Device	12
Setting Up the Lancing Device.....	12
Preparing the puncture site	13
Performing a Blood Glucose Test	13
Comparing Meter and Laboratory Results	15
CONTROL SOLUTION TEST.....	15
VIEWING RESULTS ON THE METER	16
CARE AND STORAGE FOR YOUR SYSTEM	17
Cleaning and Disinfection.....	17
METER SPECIFICATION	18
Limitations of use:.....	18
DISPLAY MESSAGE	19
Problems	20

BEFORE YOUR BEGIN

Installing the battery

1. Open the battery cover on the back of meter.
2. If replacing the batteries, please remove the used batteries.
3. Insert 2 new (AAA) batteries with correct +/- direction.
4. Close the battery cover.

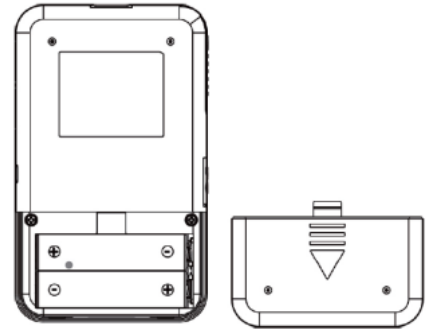

Environment Protection – Waste electrical products should not be disposed of with household waste. Please recycle where facilities exist. Check with your local Authority or retailer for recycling advice.

INTRODUCTION TO THE SYSTEM

Indications for Use

The Blood Glucose Monitoring System is intended to be used for the quantitative measurement of glucose (sugar) in fresh capillary whole blood samples drawn from the fingertip. The Blood Glucose Monitoring System is intended to be used by a single patient and should not be shared.

The Blood Glucose Monitoring System is intended for self-testing outside the body (in vitro diagnostic use) by people with diabetes at home as an aid to monitor the effectiveness of diabetes control. The Blood Glucose Monitoring System is not to be used for the diagnosis of or screening of diabetes, or for neonatal use.

The Test Strips are for use with the Blood Glucose Meter to quantitatively measure glucose drawn from the fingertips.

Caution

- The system is intended for use outside the body (in vitro diagnostic use). It is for single-patient use. It should be used only for testing glucose (sugar) and only with fresh capillary whole blood samples taken from the finger and the alternative sites including the palm, the forearm, the upper arm, the calf and the thigh. The system is intended for use at home. It should not be used for the diagnosis of diabetes or for the testing of newborns.
- The System is to be used by a single person and should not be shared.
- The System is intended for self-testing outside the body (in vitro diagnostic use) by

people with diabetes at home as an aid to monitor the effectiveness of diabetes control. Alternative site testing should be done only during steady – state times (when glucose is not changing rapidly).

- The “ Bioland ” Test Strips are for use with the Blood Glucose Meter to quantitatively measure glucose in fresh capillary whole blood samples drawn from the fingertips, palm, forearm, upper arm, calf and thigh.
- The Bioland control solutions is intended for use with the System, to check that the glucose meter and test strips are working properly and that you are doing the test correctly. These solutions contain a known range of glucose, as indicated on the strips vial bottles.
- This device is not intended for use in healthcare or assisted-use settings such as hospitals, physician’s offices, or long-term care facilities because it has not been determined to be safe and effective for use in these settings, including for routine assisted testing or as part of glycemic control procedures.
- Use of this device on multiple patients may lead to transmission of Human Immunodeficiency Virus (HIV), Hepatitis C Virus (HCV), Hepatitis B Virus (HBV), or other bloodborne pathogens.

AST in this system can be used only during steady-state blood glucose conditions described in the section of “About AST”.

Test principle

The test is based on the measurement of electrical current generated by the reaction of glucose with the reagent of the strip. The meter measures the current and displays the corresponding blood glucose level. The strength of the current produced by the reaction depends on the amount of glucose in the blood sample.

ABOUT ALTERNATIVE SITE TESTING (AST)

Important. There are limitations for doing AST.

Please consult your healthcare professional before you do AST.

What is AST?

Alternative site testing (AST) means that people use parts of the body other than the fingertips to check their blood glucose levels. This system allows you to test on the palm, the forearm, the upper arm, the calf, or the thigh with the equivalent results to fingertips testing.

What’s the advantage?

Fingertips feel pain more readily because they are full of nerve endings (receptors). At other body sites, since nerve endings are not so condensed, you will not feel as much pain as at the fingertip.

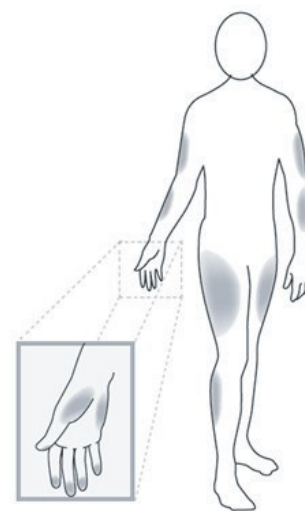

When to use AST?

Food , medication , illness, stress and exercise can affect blood glucose levels. Capillary blood at fingertip reflects these changes faster than capillary blood at other sites. Therefore when testing blood glucose during or immediately after meal, physical exercise, or any other event, take a blood sample from your finger only. You do AST only in the following instances:

- In a pre-meal or fasting state (more than 2 hours since the last meal).
- Two hours or more after taking insulin.
- Two hours or more after exercising.

NOTE:

- Alternative site testing(AST) should not be used to calibrate continuous glucose monitoring systems (CGMs).
- Results from alternative site testing should not be used in insulin doses calculations.

Do NOT use AST if:

- You think your blood glucose is low.
- You are unaware of hypoglycemia.
- You are testing for hyperglycemia.
- Your AST results do not match the way you feel.
- Your routine glucose results are often fluctuating.

CONTENTS OF THE KITS

- A Meter
- Carry Case
- Owner's Manual
- Two AAA Alkaline Batteries
- Test Strips (Optional)
- Lancing Device
- Sterile Lancet (Optional)
- Control Solution (Optional)

NOTE:

- The Lancing Device can be used for several times however the lancet should be changed after each use.
- Sterile lancet and control solution are not included in the standard kit.
- There are three levels for the control solutions: low, normal and high available, please contact the place of purchase for more information.

If any items are missing from your kit or opened prior to use, please contact local customer services or place of purchase for assistance.

Blood Glucose Meter

1. STRIP PORT: Where you insert the test strip. The meter will turn on automatically
2. DATA PORT: Located at the side is for cable connection
3. STRIP EJECTOR: Slide forward to eject the test strip after test
4. LCD DISPLAY: It guides you through the test using symbols and simple messages
5. "M" BUTTON: It is used to turn on the meter enter the memory mode
6. "S" BUTTON: It is used to set up the meter



Meter Screen Display Message

- 1) BLOOD DROP SYMBOL: Flashes when it is ready to apply the blood sample
- 2) TEST STRIPS SYMBOL: Appears when the meter is turned on
- 3) LOW BATTERY SYMBOL: Appears when the battery power is low
- 4) MEASUREMENT UNIT: Appears with the test result in mg/MI or mmol/L
- 5) CTL SYMBOL: Appears when doing a Control test and indicates That the result won't be Stored in the memory
- 6) MEMORY SYMBOL: Appears when you review the memory
- 7) TEST RESULT AREA: Displays glucose results
- 8) KETONE WARNING: Appears when your result ≥ 13.3 mmol/L (240mg/dl)
- 9) BLUETOOTH SYMBOL: Appears when transmit data
- 10) DATE
- 11) DAY AVERAGE: Indicate that the displayed test result is an average value
- 12) TIME

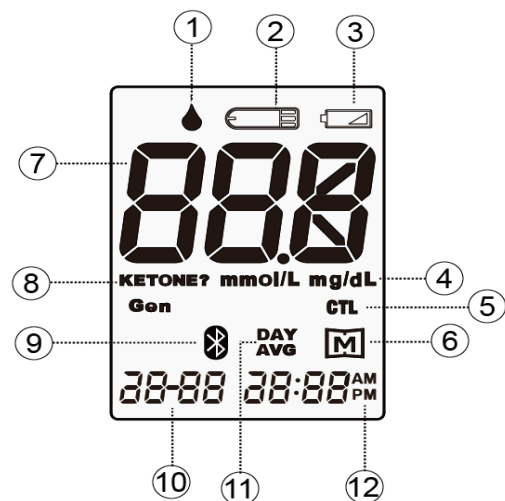

Test Strip

Each strip can be used only once. The test strip consists of the following parts:

1-Absorbent hole

Apply a drop of blood here. The blood will be drawn in automatically.

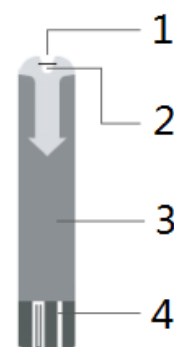

2-Confirmation window

This is where you confirm if enough blood has been drawn into the absorbent hole of the strip.

3-Test strip handle

Hold this part to insert the test strip into the slot.

4-Contact bars

Insert this end of the test strip into the meter. Push it in firmly until it will go no further.

Attention!

Test results might be wrong if the contact Bar is not fully inserted into the test slot.

The front side of the test strip should face up when inserting the test strip.

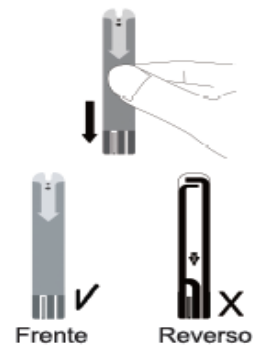

SETTING THE METER AND DELETING THE MEMORY

1. Setting the language and voice volume

1.1 Setting the language

Press and Hold "S" button for 3 seconds, until the ENG or ESP is flashing. Press "M" button to select a language you desire. Press "S".



1.2 Setting the Volume

With the Volume level number flashing, Press "M" button to select level between "0"~"7" (set "0" to turned off voice). Press "S".



2. Setting the date and time

2.1 Setting the Year

Press and Hold "S" button for 3 seconds, until the last two digits of the year will flash on the screen (for example, "14" equals 2014). Press "M" button until the correct year appears. Press "S".



2.2 Setting the month

With the month flashing, press "M" until the correct month appears. Press "S".

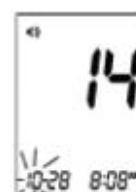

2.3 Setting the day

With the day flashing, Press “M” until the correct day appears. Press “S”.

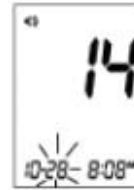

2.4 Setting the AM/PM

With the AM or PM flashing, Press “M” until the correct one appears. Press “S”.

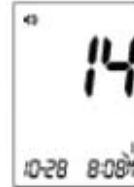

2.5 Setting the hour

With the hour flashing, Press “M” until the correct hour appears. Press “S”.

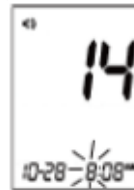

2.6 Setting the minute

With the minute flashing, Press “M” until the correct minute appears. Press “S”.

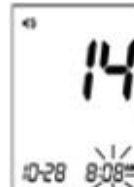

3. Deleting the Memory

Press “S” then “dEL” will display with flashing “M”.



Press “M” once, to confirm delete, press “M” button again to delete ALL

memory. The meter then displays “OK”, which means that the memory is deleted. If you don’t want to delete the memory, press the S button to skip this step. The meter will automatically turn “OFF”, and the set up will be completed.



NOTE:

- The date, time, unit and memory deletion can ONLY be set in the setting mode.
- When the meter is in setting mode, if no button is pressed within 3 minutes, the meter will turn off.
- No set up necessary, meter is pre-set. Meter is pre-set for Eastern Standard Time. Please refer to page 13 of this manual for set up instruction.

4. Speaking Function

Clever Choice Voice HD meter “speaks” with step by step instructions to guide you through the process of setting up your meter and blood glucose testing. The following table tells you when and what the meter “speaks”/

When does the meter speak?	What does the meter speak?
Setting up the meter	
Choosing the language	Setting mode, thank you for using this

	product.
Setting the voice volume	Voice volume is (number)
Setting the year	The year is (number)
Setting the month	The month is (month)
Setting the date	The date is the (number)
Setting the AM/PM	AM/PM
Setting the hour	The hour is (number)
Setting the minutes	The minutes are (number)
Deleting the memory	<ol style="list-style-type: none"> 1. Delete all record mode. Press “M” key to delete all records. 2. Are you sure? Yes, to press “M” key again. 3. All memory record have been deleted.
At the end of the meter setting	<ol style="list-style-type: none"> 1. Today’s date is (month) (day), (year) 2. The time is (hour minute)AM/PM 3. Thank you for using this product
Using the meter	
Insert test strip When the meter is ready to test.	<ol style="list-style-type: none"> 1. Test strip inserted 2. Today’s date is (month) (day), (year) 3. The time is (hour minute)AM/PM 4. Please apply blood onto the test strip.
After sample is applied onto the test strip	Beep
When the test is completed (result appears on display)	Your blood glucose is (number) milligrams per deciliter
When the test result is $< 20\text{mg/dL}$	Your blood glucose is less than 20 milligrams per deciliter
When the test result is $> 600\text{mg/dL}$	Your blood glucose is over 600 milligrams per deciliter
When selected CTL for control solution testing	Control solution mode
Recall the stored test result (press M key to turn on)	<ol style="list-style-type: none"> 1. Today’s date is (month)(day),(year) 2. The time is (hour minute)AM/PM 3. Press M key for memory recall mode 4. Memory record for (month)(day),(year) (hour minute)AM/PM 5. Your blood glucose was (number) milligrams per deciliter
Recall the average of blood glucose results	The (number) day blood glucose average is (number) milligrams per deciliter for (number) records
If no results stored in memory	No memory record available
Downloading results from your meter onto the computer	Connecting computer
When display E-b	The battery is dead, please replace

When inserted an used strip	Strip has been used
When room temperature is outside operating range, which is 50°F~104°F (10°C~40°C)	Temperature is out of range
When error message appear	Unable to measure

THE TWO MEASURING MODES

The meter provides you with two modes for measuring, General and CTL. The CTL mode should be used when a control solution is being tested. See the table below.

Modes	Use when
General test (not display)	Any time of day without regard to time since last meal
CTL	Testing with the control solution

You can switch between each mode by:

1. Start with the meter turned off. Insert a test strip to turn on the meter, the screen will display a flashing blood drop.

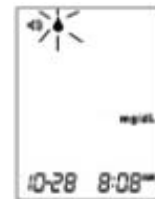

2. Press M to select General or CTL mode.

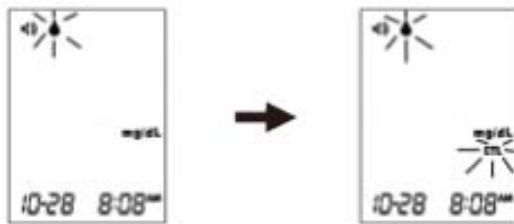

TESTING WITH BLOOD SAMPLE

CAUTION:

To reduce the chances of infection:

- Choose a clean, dry work surface.
- Never share a lancing device and lancet with another person.
- Always use a new and sterile lancet. Lancets are for single use only.
- Always use a new test strip. Test strip are for single use only.
- Avoid getting lotion, oils, dirt or debris in or on the lancet and lancing device.

Note: Before testing, please read the following steps thoroughly and carefully, please relax and do the test step by step. Simplifying or changing the test procedure may produce inaccurate results.

Overview of the Lancing Device

- A. Device Cap
- B. Handle
- C. Needle Cap
- D. Needle Holder
- E. Device Body
- F. Connecting Collar
- G. Adjustable tip
- H. Release Button
- I. Ejection Button
- J. Device control cap

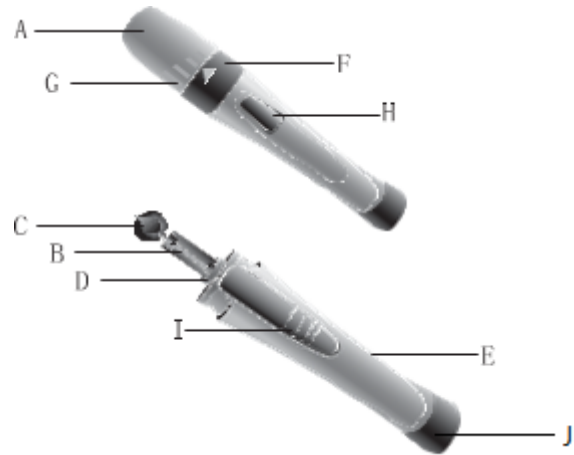

On the lancets and the lancing device.

If your lancing device differs from the one shown here, please refer to the manufacturer's manual to ensure proper usage.

NOTE:

To reduce the chance of infection:

- Never share a lancet or the lancing device.
- Always use a new, sterile lancet. Lancets are for single use only.
- Avoid getting hand lotion, oils, dirt, or debris when handling the lancets.

Setting Up the Lancing Device

1. Screw the lancing device cap off. Insert a needle into the lancet holder and push down firmly until it is fully in place.

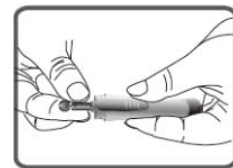

2. Screw the needle cap and place it in appropriate location to use again after finish blood-taking.

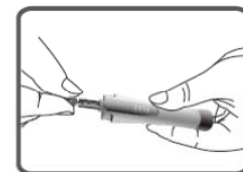

3. Replace the lancing device cap. Turn the cap until it is snug but not too tight. And then Adjust the adjustable tip to proper level.

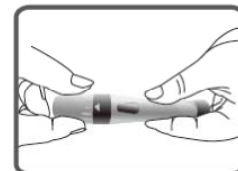

NOTE: The adjustable tip offers 5 levels of skin penetration. Twist the adjustable tip to the proper level:

- 1-2 level for soft or thin skin
- 3 level for average skin
- 4-5 level for thick or calloused skin

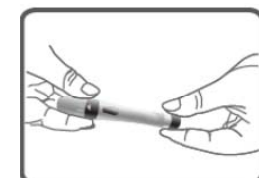

4. Pull the device control cap until it clicks. If not clicks, check the needle is installed appropriately.

5. Aiming at the sterilized part for blood-taking, press the release key to finish blood-taking.

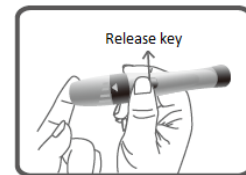

6. Screw the device cap. Push the exposed needle into the needle cap, and then push the ejection button to discard the used needle in appropriate container. Cover the device cap at last.

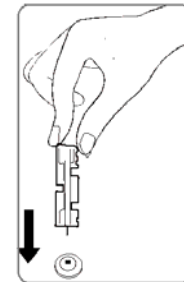

Preparing the puncture site

Stimulating blood perfusion by rubbing the puncture site prior to blood extraction has a significant influence on the glucose value obtained. Blood from a site that has not been rubbed exhibits a measurably different glucose concentration than blood from the finger. When the puncture site was rubbed prior to blood extraction, the difference was significantly reduced.

Please follow the suggestions below before obtaining a drop of blood:

- Rub the puncture site for about 20 seconds before penetration.
- Select the puncture site either at the fingertips or another body part (please see section “Alternative Site Testing” (AST) on how to select the appropriate sites).
- Clean the puncture site using cotton moistened with 70% alcohol and let it air dry.

Fingertip testing

Hold the lancing device firmly against the side of your finger. Press the release key. You will hear a click, indicating that the puncture is complete.

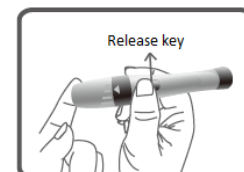

NOTE:

- Choose a different spot each time you test. Repeated punctures at the same spot may cause soreness and calluses.
- Please consult your health care professional before you begin AST.
- It is recommended to discard the first drop of blood as it might contain tissue fluid, which may affect the test result.

Performing a Blood Glucose Test

Step 1.

Wash hands with soap and warm water.

Step 2.

Remove a test strip from its vial. With clean, dry hands, you may touch the test strip anywhere on its surface. Do not bend, cut or modify the test strips in any way. Remove the test strip from the vial and use it instantly.

Step 3.

Insert the test strip into the meter's test port and the meter is turned on. The time and date appears on the screen.

NOTE: Be sure to use "Bioland" test strips, other test strips may not produce accurate results.

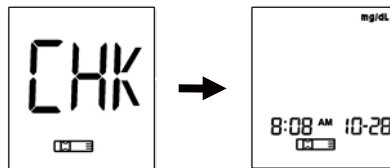

Step 4

When the blood drop symbol flashes on the screen, you may select the appropriate measurement mode, for selecting the measurement mode of Control(CTL) or General, please refer to the "THE TWO MEASURING MODES" section.

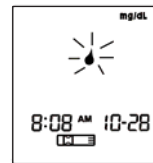

Step 5

Apply your blood to the absorbent hole of the test strip.

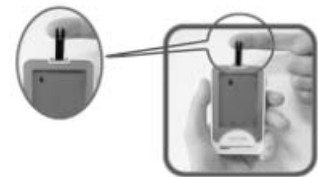

Step 6

As soon as enough blood has filled the confirmation window of the test strip, you will hear a beep letting you know the test has begun. A countdown of 5 seconds starts.

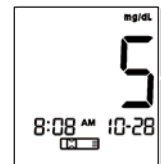

Note: make sure the confirmation window of the Test Strip is completely filled with your blood sample.

Step 7

Your blood glucose level, along date and time appears on the display. Blood glucose results are automatically stored in the memory. When bluetooth connected, Bluetooth symbol flashing, and waiting for other device with Bluetooth to scan and connect, then upload the test results data.



NOTE:

The results obtained from this meter are plasma-calibrated. This helps you and your physician or other qualified healthcare provider to compare your meter results with laboratory tests. Reference to the instructions given by your physician or other qualified healthcare provider, do not deviate from these instructions on the basis of the result without first consulting your physician.

Step 8

Eject the used test strip and remove the lancet. To eject the test strip, point the strip at a disposal container for sharp objects. The meter will switch itself off automatically after the test strip is ejected.

Please wash hands thoroughly with soap and water after handling the meter, lancing device, or test strips.

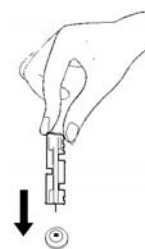

Reference value:

Time of day	Normal plasma glucose rang for people without
Before breakfast (fasting)	<100 mg/dL
Two hours after meals	<140 mg/dL

Source: American Diabetes Association. Standards of Medical Care in Diabetes-2012. Diabetes Care 2012,35 (Suppl.1)S11-S63. Please work with your doctor to determine a target range that works best for you.

Comparing Meter and Laboratory Results

The meter provides you with whole blood equivalent results. The result you obtain from your meter may differ somewhat from your laboratory result due to normal variation. Meter results can be affected by factors and conditions that do not affect laboratory results in the same way. To make an accurate comparison between meter and laboratory results, follow the guidelines below.

Before going to the lab:

- Do a control solution test to make sure that the meter is working properly.
- Fast for at least eight hours and then do comparison tests, if possible.
- Take your meter with you to the lab.

While staying at the lab:

Make sure that the samples for both tests are taken and tested within 15 minutes of each other.

- Wash your hands and then obtain a blood sample
- Never use your meter with blood that has been collected in a gray top test tube.
- Use fresh capillary blood only.

CONTROL SOLUTION TEST

Material needed:

- Glucose Meter
- Test strips
- Control solution

When to do a control solution test:

- ◆ When you suspect that the meter or test strips are not working properly.

- ◆ If your blood glucose test results are not consistent with how you feel.
- ◆ After the test strips are exposed to extreme conditions.
- ◆ After dropping the meter.

The control solution is to check that the meter and the test strips can work together as a system and work correctly.

Step 1

Insert the test strip to turn on the meter. Insert the test strip into the meter. Wait for the meter to display the drop symbol.

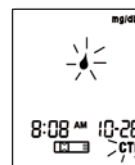

Step 2

You may press “M” button to select CTL mode, for selecting the CTL mode, please refer to the “THE TWO MEASURING MODES” section.

Step 3

Apply the control solution

Shake the control solution vial thoroughly before use.

Squeeze out a drop and wipe it off, then squeeze another drop and place it on the tip of the vial cap.

Hold the meter to move the absorbent hole of test strip so it touches the drop. Once the confirmation window fills completely, the meter will begin counting down.

To avoid contaminating the control solution, do not directly apply control solution onto a strip.

Step 4

The result of the control solutions test appears on the display. The result will not be stored under CTL mode.

The result of the control solutions test should be within the range printed on the test strip vial label. If the test results falls outside the specified range printed on test strip vial label, repeat the test. Results falling outside the specified range may be caused by:

- Error in performing the test
- Expired or contaminated Control Solution
- Expired or contaminated Test Strip
- Malfunction of your Meter

If you continue to get control solution test results that fall outside of the range printed on the vial, the system may not be working properly, Do not use the meter. Please contact your customer support immediately

NOTE: Do not use the expired control solution.

VIEWING RESULTS ON THE METER

Your meter stores the 500 most recent blood glucose test results with dates and times. It also provides 7-, 14-, 21-, 28-, 60- and 90-day averages of your blood glucose test results.

Note: The control solution readings are not included in the average of your results.

Recalling the Stored Test Results

1. Start with the meter off, press the “M” button to turn on the meter. The “M” symbol will flash with the time and date displayed on the screen.

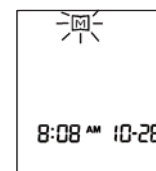

2. Press “M” again, the most recent test results with date and time will display. Press “M” once more and the next most recent test results will appear. Each time you press and release “M”, the meter will recall up to your last 500 test results in order. Press the “S” to turn off the meter. When the memory is full, the oldest result is dropped and the newest result is added.

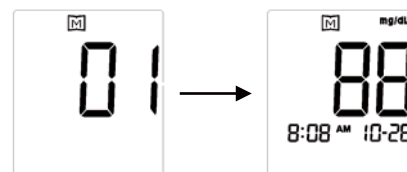

Reading the Average of Blood Glucose Results

When the meter is off, press and hold the “M” button until the DAY AVG flashing, release button then 7-day average results appear with “n024” (means 24 records to be averaged) on the screen. Press the “M” button to review the 14-, 21-, 28-, 60- and 90-day general averages. Press the “S” button to turn off the meter. Note: The control solution readings are not included in the average of your results.

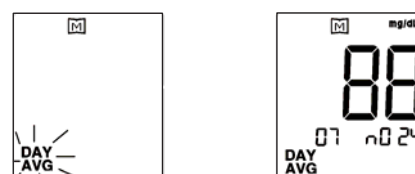

CARE AND STORAGE FOR YOUR SYSTEM

- ◆ Handle the meter with care. Dropping or throwing the meter may cause damage to the device.
- ◆ Don't expose the Blood Glucose Monitoring System, Test strip, and Control Solution, to extreme conditions, such as high humidity, heat, freezing cold or dust. The storage conditions for the test strips are 39°F~86°F, Humidity<80%RH. Storage conditions for the meter are -40°F~131°F, Humidity<80%RH.
- ◆ Always wash your hands with soap and water and rinse and dry completely before handling the Blood Glucose Monitoring system and Test strip.
- ◆ Use CaviWipes (see below) to clean the Blood Glucose Monitoring System.
- ◆ Discard the used lancet into a container for sharp objects.

Cleaning and Disinfection

The cleaning and disinfection is absolutely necessary for the test procedure, because cleaning can insure the meter works well (for example, display will be clear to see after cleaning); and disinfection can avoid the infection to you or to the other people, and the cross-infection. We strongly warn that the device should be cleaned and disinfected following use on every patient. And we suggest you use the following product: CaviWipes (EPA registration number: 46781-8) . You can purchase this product according to the following information: visit the web site: www.metrex.com or contact Metrex at 800-841-1428 for product or technical information. CaviWipes are also available at www.amazon.com or via a Google search.

The meter for single-patient use and the lancing devices may be cleaned 5-6 times per day (Test 5-6 times every day), so the meter will be cleaned and disinfected about 11000 cycles that include cleanings plus disinfections (1 cycle = 1 cleaning + 1 disinfection) during its 5 years life cycle.

1. Before the test, the user should clean and wash hands. If you are a caregiver, (not the patient), please use disposable gloves.
2. After test, take one wipe to clean the meter’s housing, buttons, lens, mark, usb cover and support block, including its front and back for 10 seconds for cleaning until there is no soil on the surface. Then disinfect the meter’s housing, buttons, lens, mark, usb cover and support block use another wipe for 2 min, keep the surface wet for 2 min.
3. Take off the glove; discard carefully according to your health- care provider’s instruction.

Note:

1. Each disinfection step requires a pre-cleaning step.
2. If the meter is being operated by a second person who is providing testing assistance to the user, the meter and lancing device shall be cleaned and disinfected first.
3. The users should wash hands thoroughly with soap and water after handling the meter, lancing device, or test strips.

METER SPECIFICATION

Model	G-427B (with “ Bioland ” test strip and control solution)
Machine size	90mm (L)×54mm (W)×13mm(H)
Weight	50g (excluding batteries)
Measuring method	Amperometric technology using glucose oxidase
Measuring range	20 mg/dL ~600 mg/dL
Blood Source	Fresh capillary whole blood
Blood Volume	Around 1.8uL
Memory	448 blood glucose tests
Display	LCD display with backlight
Power source	DC 3V (AAA×2 alkaline batteries)
Battery Life	Approx. 500 normal tests
Operating conditions	50°F~104°F, Humidity:25%~80%RH
Storage Condition (system :meter and test strips)	39.2°F~104°F and below 85% relative humidity
Storage Condition (meter)	-40°F~131°F, Humidity<80%RH, 700hPa~1060hPa
Use life	Five years

Limitations of use:



- ✘ The blood Monitoring System is not intended for use on neonates.
- ✘ The blood Monitoring System is not intended for use on artery blood, neonates’ serum and plasma.





- ※ The Blood Glucose Meter should be used with “ Bioland ” test strip.
- ※ The system can be used up to an altitude of 10744 feet.
- ※ The following substances at levels greater than normal or therapeutic levels may cause significant interference (affect the result by greater than 10%) resulting in an inaccurate result: ascorbic acid, uric acid, hemoglobin, acetaminophen, Dopamine, L-dopa, L-dopa and Tolbutamide etc. These substances do not affect test results in normal concentration but may affect test results in high concentration. Do not use haemolysis sample, icterus sample or high lipemia samples.
- ※ The following compounds, when determined to be in excess of their limitation, may produce inaccurate results:

Compound	Limitation
Ascorbic acid	> 2mg/dL
Uric acid	> 10mg/dL
Acetaminophen	> 5mg/dL
Bilirubin	> 15mg/dL
Dopamine	> 0.03mg/dL
L-dopa	> 0.45mg/dL
Methyldopa	> 0.75mg/dL
Tolbutamide	> 24mg/dL
Triglycerides	> 2000mg/dL
Hemoglobin	> 250mg/dL

- ※ Patients undergoing oxygen therapy may yield falsely lower results.
- ※ Not for use for patients in a hyperglycemic-hyperosmolar state, with or without ketosis.
- ※ Not for use on critically ill patients.
- ※ Not to be used for patients who are dehydrated, hypertensive, hypotensive or in shock.
- ※ Very low (less than 20%) or very high (more than 60%) red blood cell count (hematocrit) can lead to incorrect test results. If you do not know your hematocrit level, please consult your health care provider.

DISPLAY MESSAGE

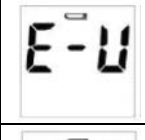
MESSAGE	WHAT IT MEANS	ACTION
	Blood glucose level is lower than 20mg/dl (1.1mmol/L)	The message indicates very low blood sugar. You should consult with your healthcare professional.
	Blood glucose level is higher than 600 mg/dl (33.3mmol/L)	This indicates severe hyperglycemia (high blood glucose). You should seek immediate medical assistance.

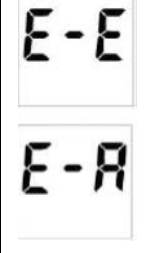
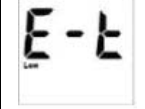
	Meter is ready to test control solution under the CTL state.	Please place a drop of control solution onto the test well of test strip.
	Battery power is low.	Please change the battery.
MESSAGE	WHAT IT MEANS	ACTION
	Use a used test strip	Please use a new strip and re-test
	Error message indicates that you may remove the strip after applying blood to the absorbent hole	Try again with a new test strip
	Problem with the meter	Re-test with a new test strip. If the problem is still unsolved, please call the customer care line for help.
	Environmental temperature is lower than 50°F ~104°F	Please test at an environmental temperature within 50°F ~104°F operation range

Problems

Problems	Causes	Solutions
Display remains blank after the test strip has been inserted into the Meter.	<ol style="list-style-type: none"> 1. Battery may be installed improperly. 2. Battery power is too low for use. 3. Too much time has passed between inserting the Test Strip and performing the test. 4. Test Strip has not been fully inserted into the Meter. 	<ol style="list-style-type: none"> 1. Install the Battery correctly. 2. Replace with new Battery. 3. Reinsert the Test Strip into the Meter. 4. Reinsert the Test Strip into the Meter.
Test results are inconsistent or Control Solution test results are not within the specified range.	<ol style="list-style-type: none"> 1. Not enough sample in the Test Strip. 2. Test Strip or Control Solution has expired. 3. Test Strip has been damaged due to heat or humidity so that sample cannot be applied or the speed of applying sample is too slow. 4. System is not performing due 	<ol style="list-style-type: none"> 1. Redo test with new test strip and make sure that enough sample has been added. 2. Redo test with new test strip. 3. Perform a Control Solution test using a new Test Strip. If results are still out of range, replace with new vial of Test Strips. 4. Bring System to a room temperature environment and

	to the environment being above or below room temperature.	wait approximately 30 minutes before performing a new test.
The Meter countdown did not start.	Test Strip has not been inserted correctly.	Use a new Test Strip and redo the test.

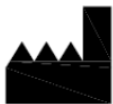

Bioland Technology LTD.

No. A6B7 (Block G) ShangRong Industrial Zone No. 5 Baolong Road, Baolong Community Longgang District 518116, Shenzhen, Guangdong PEOPLE'S REPUBLIC OF CHINA

Version: V1.0 @ 2016-01 by Bioland Technology LTD.