

NESS L300™

User's Guide

User Guide Copyright

© 2006 NESS Ltd.

All rights reserved.

No part of this publication may be reproduced, transmitted, transcribed, stored in a retrieval system, or translated into any language or any computer language, in any form or by any third party, without the prior written permission of NESS Ltd.

Trademarks

NESS is a trademark of NESS Ltd.

NESS L300™ is a trademark of NESS Ltd.

Disclaimer

NESS Ltd. shall not be liable for any injury or damage suffered by any person, either directly or indirectly, as a result of the unauthorized use or repair of NESS Ltd's products. NESS Ltd. does not accept any responsibility for any damage caused to its products, either directly or indirectly, as a result of use and/or repair by unauthorized personnel.

Environmental Policy



Service personnel are advised that when changing any part of the NESS L300™, care should be taken to dispose of those parts in the correct manner; where applicable, parts should be recycled. When the lifecycle of the NESS L300™ has been completed, the product should be discarded according to the laws and regulations of the local authority.

For more detailed information regarding these recommended procedures, please contact your local or regional NESS L300™ distributor.

NESS is committed to continuously seeking and implementing the best possible manufacturing procedures and servicing routines.

Conformity Certification



Caution: Federal law restricts this device to sale by or on the order of a physician.

Manufacturer



NESS Ltd. 19 Ha'haroshet St., Keidar Center, P.O. Box 2500, Ra'anana, 43654, Israel

Tel: (972) 9-748-5738 Fax: (972) 9-748-5740, Email: ness@ness.co.il, Website: www.nessltd.com

U.S. Distributor



Bioness Inc. 25134 Rye Canyon Loop Suite 300
Santa Clarita, California 91355

Tel: (800) 211-9136 Fax: (661) 362-4851

Email: info@bionessinc.com

Website: www.bionessinc.com

European Distributor



Ness Europe B.V, Zadelmakerstraat 53

2984 CC Ridderkerk, The Netherlands

Tel: 31-180-481600 Fax: 31-180-463152

Email: ness@ness.nl

Website: www.ness.nl

Contents

1. Introduction to your NESS L300™	1
Indications For Use.....	1
Advanced Technology in Rehabilitation.....	1
For Your Health and Safety.....	2
2. General Overview of your NESS L300™	7
Components of the NESS L300™	7
The Orthosis.....	8
Indicator lights on the RF Stim Unit.....	9
The Foot Sensor.....	10
The Control Unit.....	11
Control Unit Buttons.....	12
Control Unit Display and Audio Indication.....	13
3. Operating Modes	15
Standby Mode.....	15
Gait Mode.....	15
Training Mode.....	15
4. Daily Use of your NESS L300™	17
Activating and Using the System.....	17
Positioning the Orthosis on your leg.....	18

Taking the Orthosis off.....	22
Operating the Control Unit.....	22
5. Care and Maintenance.....	25
Batteries.....	25
Low Battery Warning.....	25
Charging the Batteries.....	26
Replacing the Batteries.....	29
Replacing Electrodes.....	31
Cleaning your NESS L300™.....	35
6. Replacing and Installing System Components.....	37
Replacing and Registering Components.....	37
Removing and Installing the RF Stim Unit.....	39
Placing a Foot Sensor in your Shoe.....	40
7. Accessories.....	43
8. Troubleshooting.....	45
9. Specifications.....	49
10. List of Symbols.....	55

List of Figures

Figure 1: NESS L300™ System Components	7
Figure 2: The Orthosis	8
Figure 3: The Foot Sensor	10
Figure 4: The Control Unit	11
Figure 5: Recommended Knee Angle for Orthosis Application	18
Figure 6: Placing the Orthosis on the Leg	19
Figure 7: Fastening the Strap	20
Figure 8: Orthosis Fastened in Place	21
Figure 9: RF Stim Unit and Control Unit Charging Sockets	26
Figure 10: Connecting the Charger	27
Figure 11: Control Unit Charging Indicators	28
Figure 12: RF Stim Unit charging Indicators	28
Figure 13: Replacing the Foot Sensor's Battery	29
Figure 14: Replacing the Control Unit's Battery	30
Figure 15: Removing Used Electrodes	31

Figure 16: Removing a New Electrode from its Cover.....	32
Figure 17: Attaching a New Electrode	32
Figure 18: Removing the Protective Liners.....	33
Figure 19: Attaching the Electrode Cover.....	34
Figure 20: Display while Registering	38
Figure 21: Removing the RF Stim Unit from the Orthosis	39
Figure 22: Foot Sensor Adhesive Pad in a Shoe.....	40
Figure 23: Foot Sensor in Place under Insole	41
Figure 24: Transmitter in Place (Left Shoe Shown).....	42
Figure 25: Accessories	45

Introduction to your NESS L300™

Indications For Use

The NESS L300™ is intended to provide ankle dorsiflexion in individuals with foot drop following an upper motor neuron injury or disease. During the swing phase of gait, the NESS L300™ electrically stimulates muscles in the affected leg to provide dorsiflexion of the foot; thus, it may improve the individual's gait. The NESS L300™ may also facilitate muscle re-education, prevent/retard disused atrophy, maintain or increase joint range of motion and increase local blood flow.

Advanced Technology in Rehabilitation

Central nervous system injuries often cause a gait disorder called "Foot Drop" which is the inability to raise the foot while walking and therefore results in dragging of the foot, instability and increased effort during gait.

The NESS L300™ is an advanced Neuroprosthesis designed to improve gait in people suffering from foot drop as a result of a central nervous system injury or disease.

The NESS L300™ system is comprised of an Electronic Orthosis, Foot Sensor and Control Unit. These components communicate wirelessly, thus enabling easy and comfortable use without cumbersome wires. The NESS L300™ delivers electrical pulses to the Peroneal Nerve which controls the movement of the calf muscles, causing them to raise the foot at the appropriate phase of walking and therefore prevents foot drop.

The Orthosis can be used single handedly and its advanced ergonomic design ensures constant and snug contact between the user's limb and its

integrated electrodes. While walking, the Foot Sensor detects whether the foot is in the air or on the ground and transmits that information to the rest of the system which accordingly activates the foot.

The wireless Control Unit displays information regarding the system's status and manages the various system components.

The NESS L300™ system incorporates cutting edge technology and sophisticated ergonomics in order to improve your walking and quality of life.

Please read this guide carefully in order to maximize the benefits provided by this advanced system.

For Your Health and Safety

Contraindications

- Patients with a demand-type cardiac pacemaker should not use the NESS L300™.
- Stimulation should not be applied over, or in proximity to cancerous lesions.
- The NESS L300™ should not be used over areas of regional disorders, such as a fracture or dislocation, which would be adversely affected by motion from the stimulation.
- Patients with an implanted electronic metallic device (for example a cardiac pacemaker or defibrillator) should not be subjected to stimulation unless specialist medical opinion has first been obtained.

Warnings

- The long-term effects of chronic electrical stimulation are unknown.
- The Orthosis should not be applied over swollen, infected, or inflamed areas or skin eruptions, e.g., phlebitis, thrombophlebitis, varicose veins, etc.
- Simultaneous connection of the L300™ to the patient and to high-frequency surgical equipment may result in burns at the site of the stimulator electrodes and possible damage to the RF Stim Unit of the Orthosis.
- Do not use the NESS L300™ in close proximity (less than 3 feet) to short wave or microwave therapy equipment as it may produce instability in the RF Stim Unit output.
- System configuration should only be performed by an authorized clinician.

Precautions

- Inflammation in the region of the NESS L300™ may be aggravated by motion, muscle activity or pressure from the Orthosis. Use of the device should be temporarily halted until the inflammation clears.
- Caution should be used for patients with suspected or diagnosed heart problems.
- Caution should be used in the presence of the following:
 - When there is a tendency to hemmorage following acute trauma or fracture.
 - Following recent surgical procedures when muscle contraction may disrupt the healing process.
 - Over areas of the skin which lack normal sensation.

- Caution should be used for patients with suspected or diagnosed epilepsy.
- Some patients may experience skin irritation or hypersensitivity due to the electrical stimulation or electrical conductive medium. The irritation can usually be reduced by using an alternate conductive medium or alternate electrode placement.
- Electrode placement and stimulation settings should be based on the guidance of the prescribing practitioner.
- The NESS L300™ should be used only with electrodes supplied by NESS Ltd.
- Specific physician clearance should be obtained prior to use in patients with alteration of normal arterial or venous flow due to local insufficiency, occlusion, arterio-venous fistula for the purpose of hemodialysis, or primary disorder of the vasculature.
- Specific physician clearance should be obtained when there is a structural deformity or placement of metal implant in the area to be stimulated.
- The safety of the NESS L300's use during pregnancy has not been established.
- Skin problems in areas of contact with the Orthosis may be aggravated by use of the NESS L300™.
- The NESS L300™ should be turned off before removing or replacing the electrodes.
- The NESS L300™ should be kept out of the reach of children.
- The NESS L300™ Control Unit is splash proof. However, it should be protected from any contact with water such as dampness from sinks, bathtubs and shower stalls, from weather such as rain or snow or any other source of water.

- Do not leave the NESS L300™ stored in a car in hot weather where the temperature may exceed the recommended storage temperature and could cause damage to the device.
- Should any technical problem occur, that is not covered in the troubleshooting section of this manual, contact your clinician or NESS L300™ distributor. Do not attempt to repair your NESS L300™.
- The Orthosis is meant to be worn only on the leg of the user for whom it is fitted. It should not be applied to anyone else or any other part of the body.
- Put on the Orthosis only when the NESS L300™ is turned off. Do not activate it until it is fastened in place.
- The system should not be used while driving, operating machinery, or during any activity in which involuntary muscle contractions may put the user at undue risk of injury.

Adverse Reactions

In the unlikely event of any of the following occurrences, stop using your NESS L300™ immediately and consult your personal physician.

- Signs of significant skin irritation or pressure sores on the limb in areas of contact with the Orthosis.
- A significant increase in muscle spasticity.
- A feeling of heart-related stress during stimulation.
- Swelling of the leg, knee, ankle, or foot.
- Skin irritations and burns have been reported with the use of powered muscle stimulators.
- Any other unanticipated reaction.

Radio Communication Information

This device complies with Part 15 of the FCC Rules. Operation is subject to the following conditions:

- This device may not cause harmful interference.
- This device must accept any interference received, including interference that may cause undesired operation.

Parts of the NESS L300™ communicate via radio communication and have been tested and found to comply with the limits for a Class B digital device, pursuant to Part 15 of the FCC Rules. These limits are designed to provide reasonable protection against harmful interference in a residential installation. This equipment generates, uses, and can radiate radio frequency energy and, if not installed and used in accordance with the instructions, may cause harmful interference to radio communications. However, there is no guarantee that interference will not occur in a particular installation. If this equipment does cause harmful interference to radio or television reception, which can be determined by turning the equipment off and on, the user is encouraged to try to correct the interference by one or more of the following measures:

- Reorient or relocate the receiving antenna.
- Increase the separation between the equipment and receiver. Consult the dealer or an experienced radio/TV technician for help.

The antenna for each transmitter must not be co-located or operating in conjunction with any other antenna or transmitter.



Changes or modifications to this equipment not expressly approved by NESS Ltd. could void the user's authority to operate the equipment.

General Overview of your NESS L300™

Components of the NESS L300™

The NESS L300™ is supplied with the following components:

- Control Unit
- Orthosis & RF Stim Unit
- Foot Sensor & Adhesive pads
- Electrodes
- Charger
- User's Guide
- Carrying case

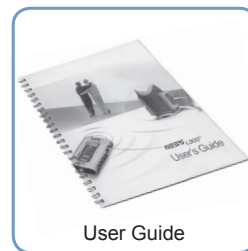
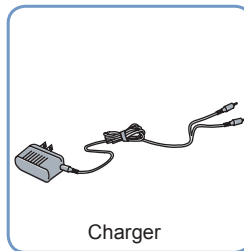
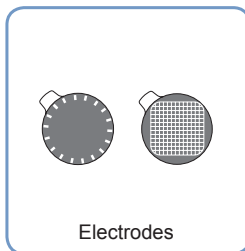
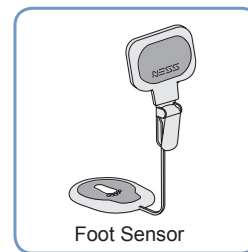
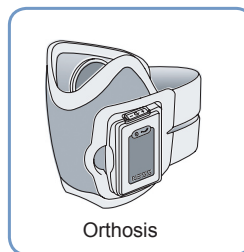
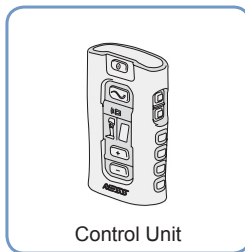
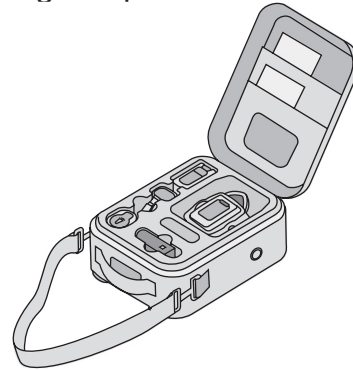

Figure 1: NESS L300™ System Components

The Orthosis

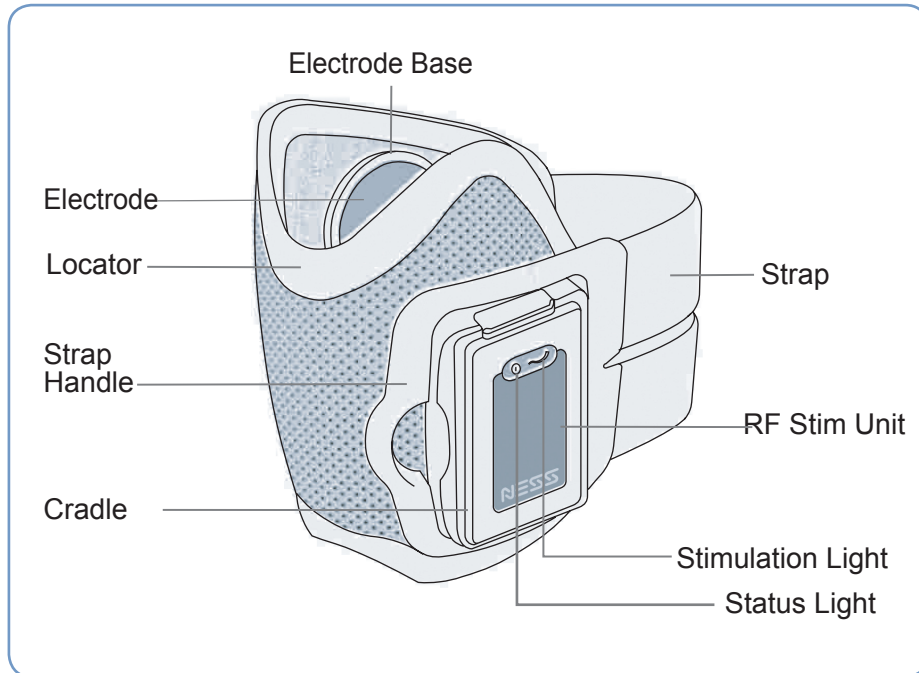







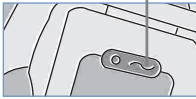

Figure 2: The Orthosis

- The Orthosis is light weight and has a low profile allowing it to be positioned under trousers.
- It is anatomically designed to allow accurate placement on the leg.
- The RF Stim Unit is integrated into the cradle on the Orthosis. It may be snapped in or out of the Orthosis for maintenance.

- The device is held in place by a strap which may be fastened using only one hand.
- Two electrodes are attached to their bases on the inner lining of the Orthosis; their position in the Orthosis has been carefully determined by the clinician during the fitting process. The electrodes may be easily replaced by the user without changing their positions.

Indicator lights on the RF Stim Unit

Indicator lights on the RF Stim Unit displays the unit's status and when stimulation occurs.

Indicator	Display	Display Pattern	Description
Status Light 		Flashes green	System on
		Flashes yellow	Low battery
		Alternating between yellow and green	Charging
		Constant Green	Battery fully charged
Stimulation Light 		Flashes slowly yellow	Stimulation inactive
		Flashes rapid yellow	Stimulation applied

The Foot Sensor

The Foot Sensor (Figure 3) detects whether the foot is on the ground or in the air and transmits radio signals to the RF Stim Unit according to which stimulation is activated.

The Foot Sensor consists of a pressure sensor worn underneath the insole of the shoe and a small transmitter attached to the upper edge of the shoe by a clamp.

There is no need to detach the Foot Sensor between uses.

The Foot Sensor is powered by a small non-rechargeable battery which needs replacing after approximately every six months of use.

The Foot Sensor by default should be placed under the paretic (weak) foot.

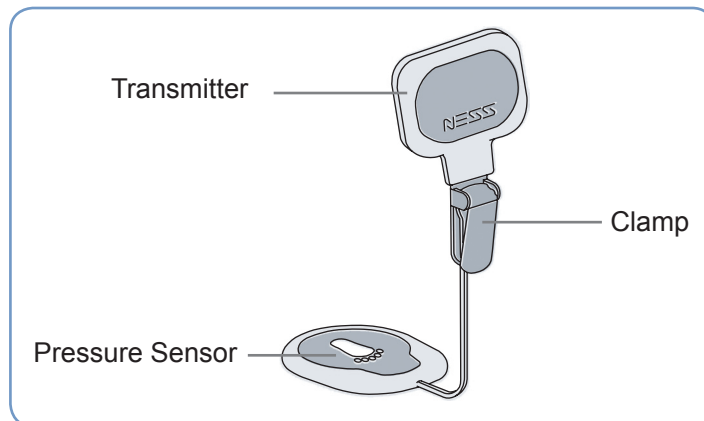

Figure 3: The Foot Sensor

The Control Unit

The Control unit (see figure 4) enables the user to activate/deactivate the system, select the operation mode, fine-tune the stimulation intensity and receive information regarding the system by visual and audio indicators.

During operation, the Control unit maintains communication with the RF Stim Unit in the Orthosis and Foot Sensor.

It can be carried in a pocket, belt pouch or around the neck using the neck strap supplied.

The Control Unit is powered by a single rechargeable AAA battery.

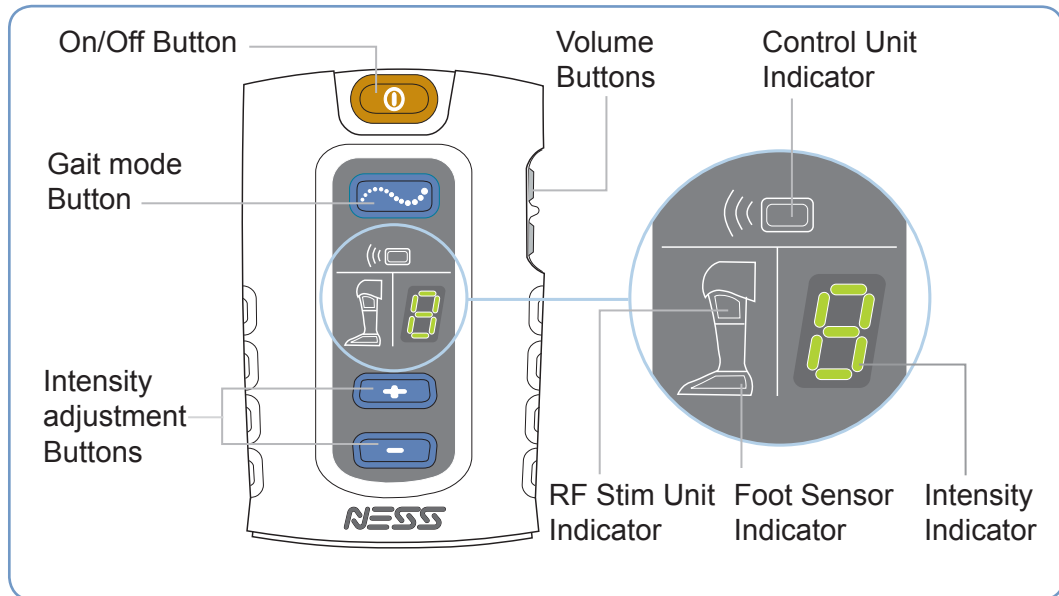
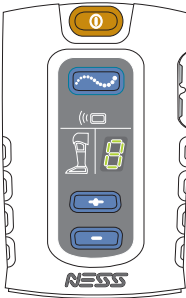







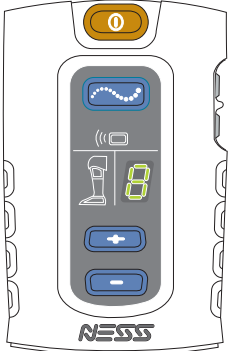







Figure 4: The Control Unit

Control Unit Buttons

Control Unit	Operating Button		Description
	ON/OFF		Turns the Control Unit ON and OFF
	Gait mode		Selects Gait, Training or Standby Mode
	Volume Adjustment	 	Adjusts the volume of the audio indications
	Intensity	 	Adjusts the intensity of stimulation

Control Unit Display and Audio Indications

Visual Indications





Control Unit	Display	Display Pattern	Description
		Flashes Green	System is ON
		Flashes Yellow SLOWLY	System in Gait or Training mode, but not Stimulating
		Flashes Yellow RAPIDLY	System in Gait or Training mode and Stimulating
		Displays 0 - 9	Intensity level
		Alternates "t" and the intensity level	Training mode
		One of the Indications Flashes Yellow	Low Battery
		Rotating Circle	Charging
		Horizontal Line	Fully Charged

Audio indications

The audio alert beeps when:

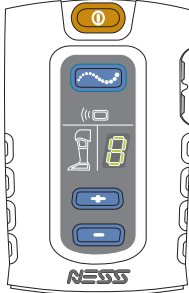
- The system is first turned ON.
- A button is pressed.
- Low battery.
- There is a malfunction accompanied by a visual indication.

Error indications

Display	Display	Flash	Meaning
		The RF Stim Unit's Indicator is Constantly Red and "E" appears on the Intensity Indicator	Bad Electrode Contact
		All indicators flash Red and "E" flashes on the Intensity Indicator	Radio Communication failure between the Control Unit and RF Stim Unit
		The Foot Sensor's Indicator is Constantly Red and the Intensity value flashes	Foot Sensor not found by the system
		One of the Indicators is Constantly Red	Component Malfunction

Operating Modes

Standby mode

The system is ON, and waiting for commands. Stimulation is not applied in Standby mode.

Gait mode

Select this mode for walking. In Gait mode the stimulation is synchronized by the Foot Sensor, in order to achieve foot lifting while the foot is in the air and foot rest while the foot is on the ground.

Training mode

Select this mode for muscle training while you are sitting or lying down. The purpose of the training mode is to facilitate muscle re-education, prevent retard disuse atrophy of the calf muscles, maintain or improve range of motion of the ankle joint and improve local blood circulation.

In the training mode the stimulation is applied in pre-determined cycles adjusted by your clinician and works independently of the Foot Sensor.



The training mode can also be used to check if the Orthosis was placed accurately on the leg. If the foot does not respond to the stimulation as it should, reposition the Orthosis.

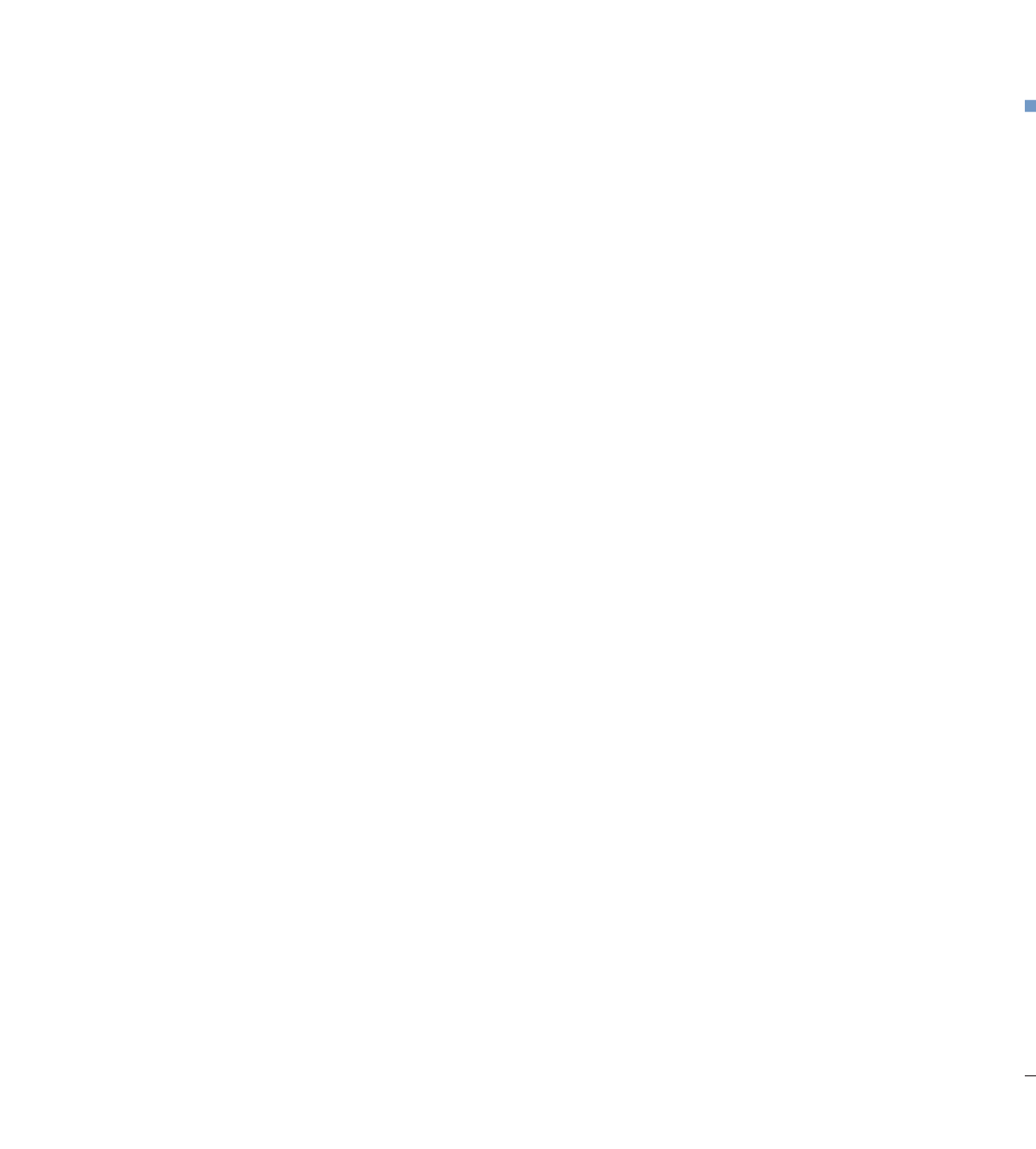

Daily Use of your NESS L300™

Activating and Using the System

1. Position the Orthosis on your leg.
2. Turn ON the Control unit.
3. Select either GAIT or TRAINING mode.
4. Begin walking or let the training mode exercise your leg.



Before using the system make sure the Foot Sensor is installed. If not install it according to the section “Placing the Foot Sensor in your Shoe”.

Positioning the Orthosis on your leg

1. While seated, slightly extend your leg as seen in Figure 5. This causes the outline of the kneecap to be clearly defined. It may be helpful to place your foot on a small stool or footrest.

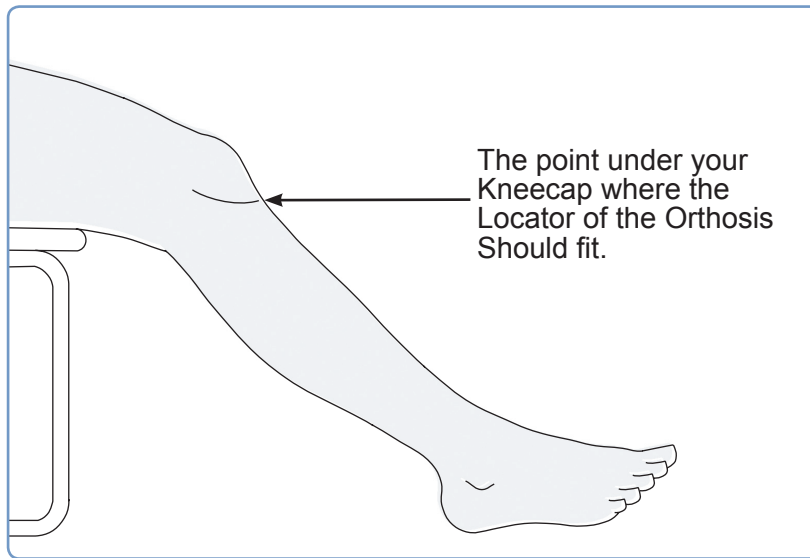

Figure 5: Recommended Knee Angle for Orthosis Application

2. Grasp the Orthosis around the cradle area and tilt it towards you, slide the Orthosis up your leg, until the "U" of the Locator reaches the lower part of the kneecap, as seen in Figure 6.

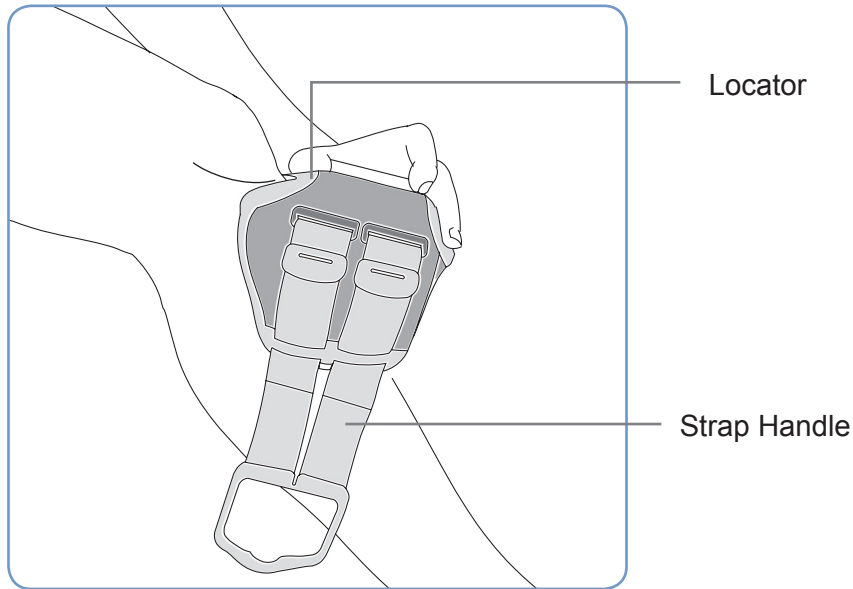

Figure 6: Placing the Orthosis on the Leg

After the Orthosis is in position, push the Orthosis against the leg. The Orthosis will gently grip the leg.

3. To fasten the Orthosis strap, grasp the handle of the elastic strap with the fingers of the *opposite* hand (see Figure 7), then hook your thumb around the cradle in order to hold the Orthosis in place while you pull the handle around the cradle.

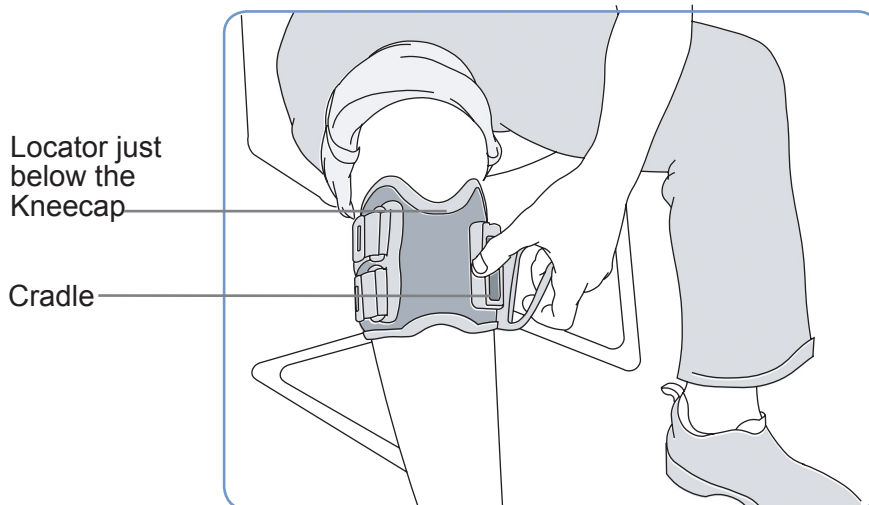

Figure 7: Fastening the Strap



Fastening the strap can be performed with one hand although if the other hand is functional, it can also be used.

4. At this stage you should check to see if visually the Orthosis is in place (see figure 8). If not, take the Orthosis off and put it back on accurately.

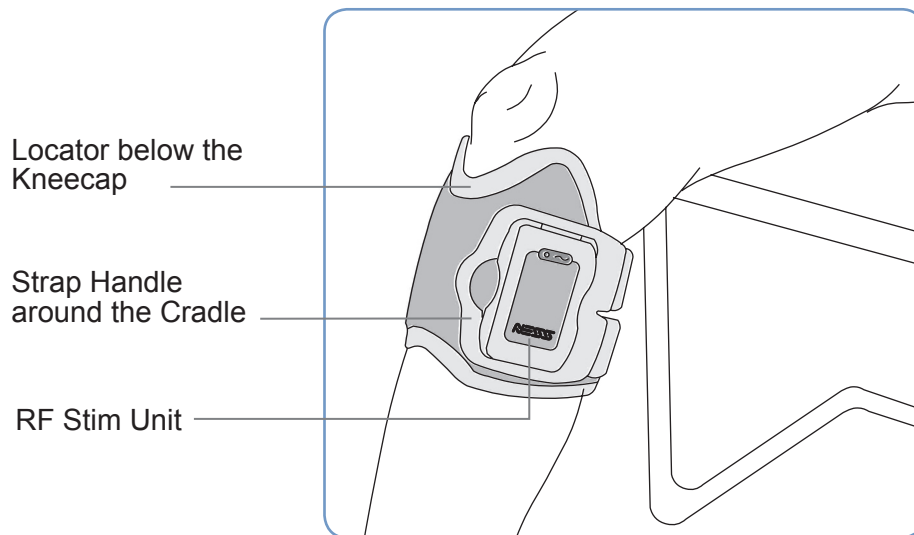



Figure 8: Orthosis Fastened in Place

Taking the Orthosis OFF

1. Make sure the system is OFF.
2. Unhook the strap handle from the cradle and take the Orthosis off.
3. Place the electrode cover over the electrodes.
4. Charge the Control Unit and RF Stim Unit's batteries fully at the end of your daily use (see Charging the Batteries).



Operating the Control Unit

Turning ON the system



Press the  button once. The system starts in standby mode. All display indicators light up for a few seconds while the system performs a self-test, then the  button flashes green to indicate that the system is activated.

Selecting the Mode



To select the gait mode:

After the unit is turned on, press the  button once briefly. You should hear a beep and the  button will start to flash slowly. During stimulation the button flashes rapidly.



To select the training mode:

After the unit is turned on, press and hold the  button until a beep is heard. The  button will start to flash slowly. In addition, the intensity indicator displays a “t” alternating with the intensity level.

To return to standby mode:

From the gait or training mode, press the  button again briefly. You will hear a beep and the  button will stop flashing.

Adjusting the Stimulation Intensity Level

When the Control Unit is turned on, the stimulation intensity level starts at level 5, which is the default stimulation intensity level. Normally there is no need to adjust the stimulation intensity; however, it may be necessary while walking on different surfaces or with various shoes. When necessary, the stimulation level can be manually adjusted by pressing the  or  buttons on the Control Unit.



If the intensity is reduced to 0, no stimulation will be applied.

To lift the foot higher:

If the foot slightly drags or catches on the floor while walking, the stimulation level can be increased by pressing the  button.

To decrease foot lift:

If your foot rises too high while walking or if the stimulation is unpleasant, the intensity level can be reduced by pressing the  button. Be sure that your foot does not drag or catch on the floor after reducing the intensity level.

When the intensity level is altered, its level appears on the display of the Control Unit and a corresponding beep is emitted.

Adjusting the Volume of the Audio Indication

Use the  buttons to adjust the volume:

- Each time one of the buttons is pressed the volume increases or decreases. You will hear a corresponding beep at the volume you select.
- Reducing the volume to the minimal setting mutes the Control Unit.
- When you turn the system off, the volume level is saved unless the volume is set to "mute", in which case the volume level is automatically adjusted to the default level.



While using the system, the various components of your NESS L300™ must not be separated. If the system components are separated for any reason, radio contact will be lost and the system will cease all activity until communication is re-established.



Care and Maintenance

Batteries

 *The batteries should be charged before the first use, after every day's use, and after extended storage.*

Low Battery Warning

When one of the batteries is low, its indicator light on the Control unit flashes yellow. For more information see the following table:

Indication	Display	Warning Indication	Time left (approximately)
Low battery in the Control Unit		Slow flash accompanied by an audio indication	Four hours
		Medium flash speed with an audio indication every 10 minutes	One hour
		Rapid flashing with an audio indication every 1 minute	Ten minutes
Low battery in the RF Stim Unit		Slow flash accompanied by an audio indication	Four hours
		Medium flash speed with an audio indication every 10 minutes	One hour
		Rapid flashing with an audio indication every 1 minute	Ten minutes
Low battery in the Foot Sensor		Slow flash accompanied by an audio indication	Fourteen days
		Medium flash speed with an audio indication every two hours	Seven days
		Rapid flashing with an audio indication every hour	Two days
		Rapid flashing and an audio indication every 30 seconds	Fifteen Minutes

Charging the Batteries

Control Unit and RF Stim Unit



- *Both the Control Unit's and RF Stim Unit's batteries are rechargeable.*
- *Remove Orthosis from leg while charging.*

1. Open the cover of the charging socket at the bottom of the Control Unit and at the top of the RF Stim Unit as seen in Figure 9.

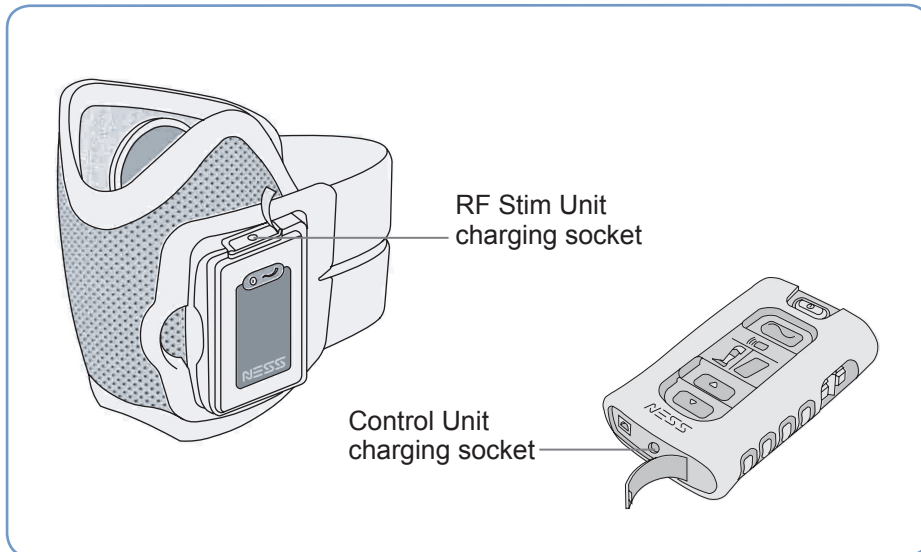



Figure 9: RF Stim Unit and Control Unit Charging Sockets

2. Connect the charger cable to the Control Unit and to the RF Stim Unit as seen in Figure 10 and plug into the wall socket. A rotating circular  icon will appear on the Control Unit's display and the status light on the RF Stim Unit will start flashing alternating yellow/green  .

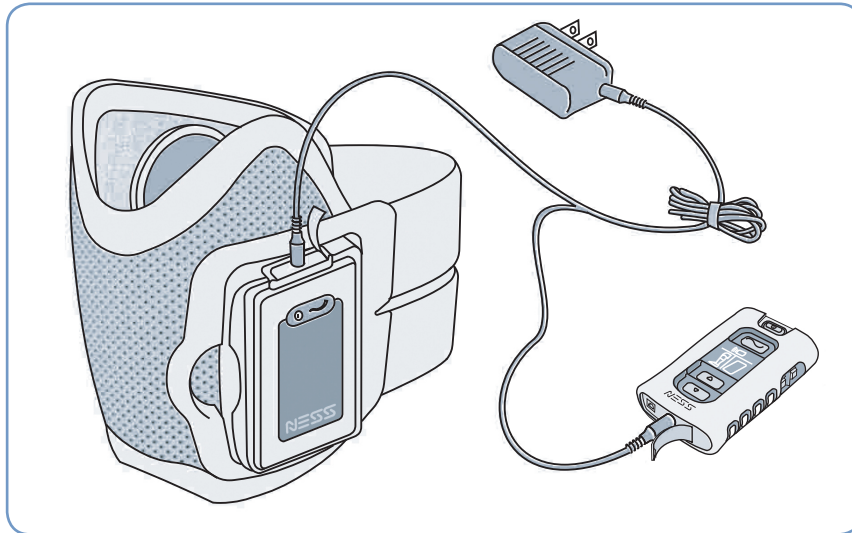

Figure 10: Connecting the Charger



3. Leave the charger connected until the  appears on the Control Unit's display and the RF Stim Unit's status light turns a constant green , indicating a full charge. The charging process should last approximately 3 hours.



Figure 11: Control Unit Charging Indicators

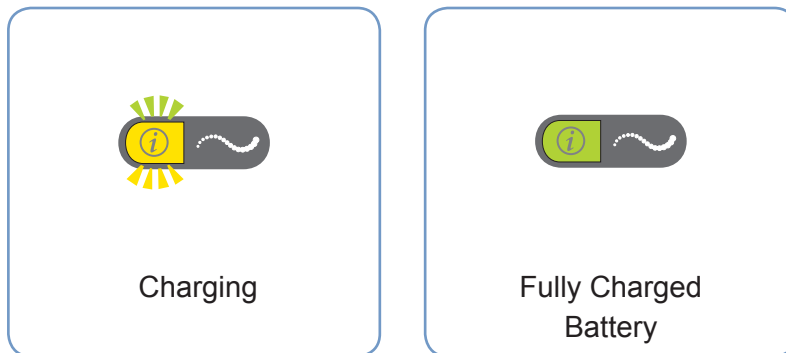

Figure 12: RF Stim Unit Charging Indications

Replacing the Batteries

RF Stim Unit

The RF Stim Unit's battery needs replacing approximately every 2 years by a NESS certified technician.

Foot Sensor

The battery in the Foot Sensor is not rechargeable, and needs replacing approximately every 6 months.

To install a new battery (**Lithium coin cell, CR2430**):

1. Unscrew the two screws from the battery cover.
2. Slide the cover out.
3. Remove the old battery.
4. Insert the new battery (The “+” should face outwards).
5. Slide the cover back into place and reinstall the screws.

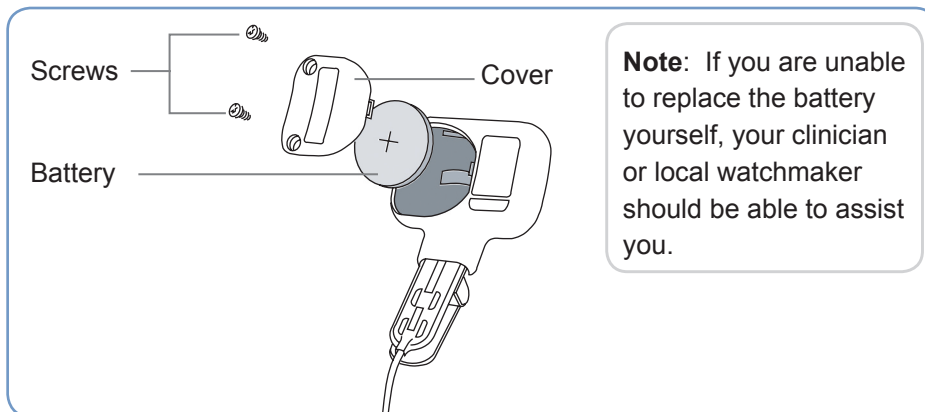

Figure 13: Replacing the Foot Sensor's Battery

Control Unit

The Control Unit's battery is a rechargeable AAA battery and needs replacing approximately every 2 years.

1. Remove the screw from the battery cover on the back of the Control Unit. (The screw may be under an ID sticker-gently peel it off the screw).
2. Remove the battery cover.
3. Remove the old battery.
4. Insert a new battery (rechargeable AAA), according to the polarity marks in the battery socket.
5. Slide the cover back into place.
6. Tighten the screw.

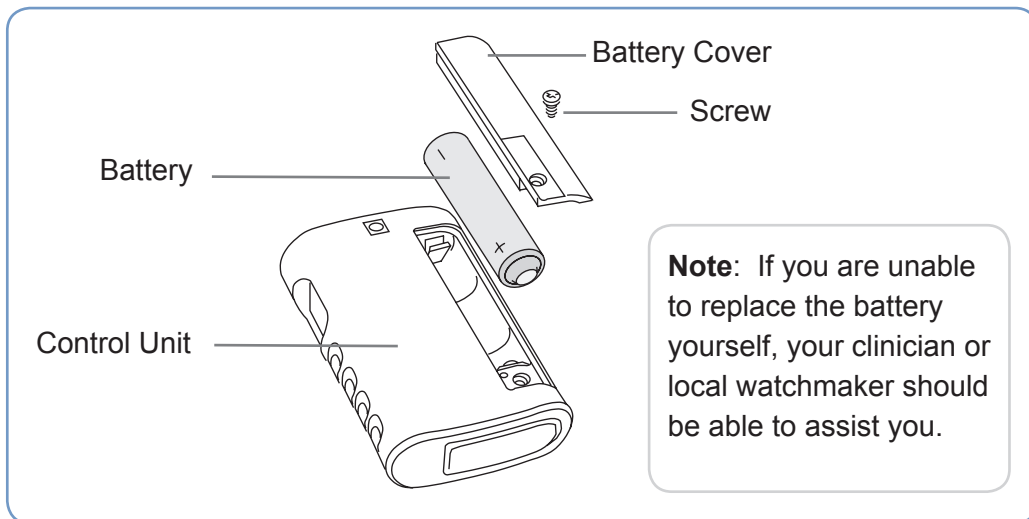

Figure 14: Replacing the Control Unit's Battery

Replacing Electrodes

- The electrodes should be replaced at least every 2 weeks. It is recommended to replace the electrodes regularly in order to maintain optimal efficiency.



The NESS L300™ should be used only with electrodes supplied by NESS Ltd.

1. Make sure the system is OFF.
2. Pull the used electrodes gently out of their bases (See Figure 15). Take care not to detach the electrode bases from the Orthosis.

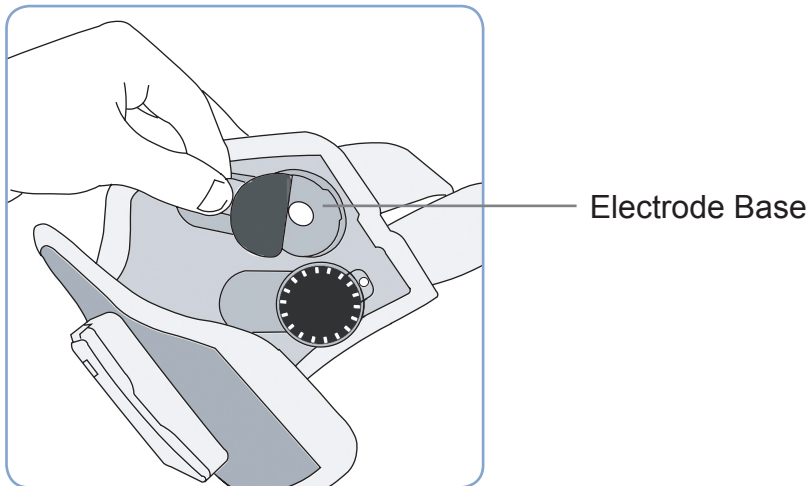

Figure 15: Removing Used Electrode

3. Pull a new electrode off the electrode cover.

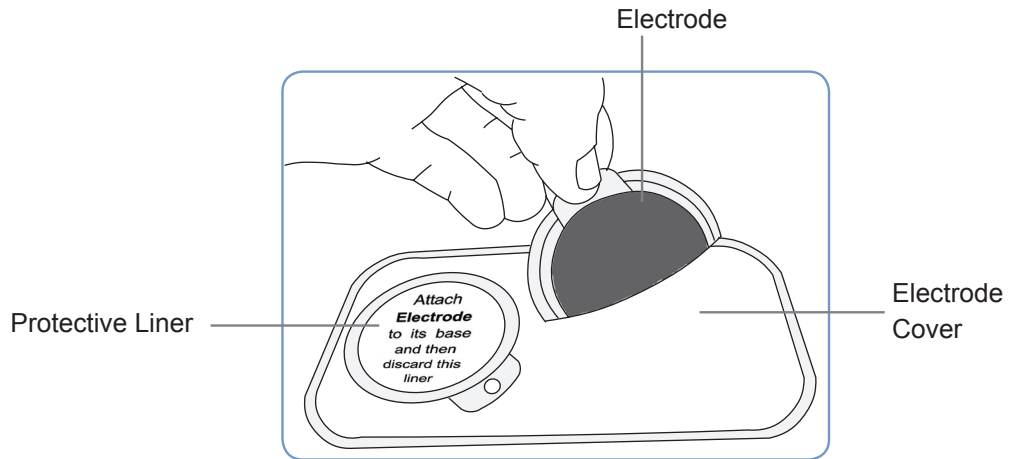

Figure 16: Removing a New Electrode from its Cover

4. Attach the new electrode to its base.

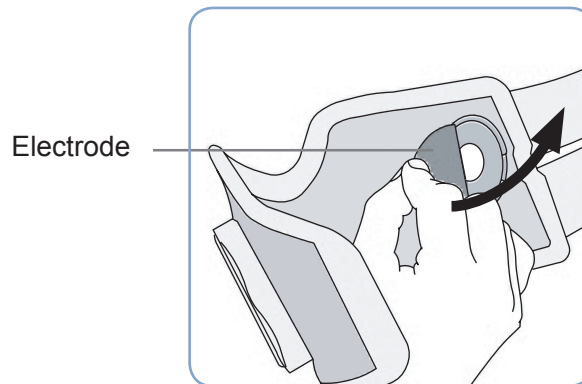

Figure 17: Attaching a New Electrode

5. Remove and discard the protective liners from the electrodes before using the system.

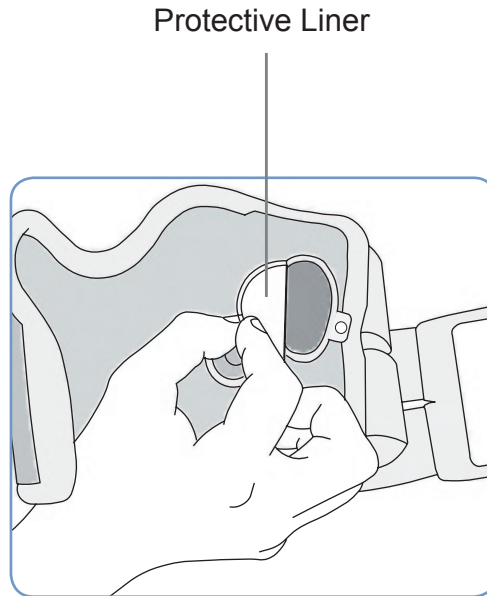

Figure 18: Removing the Protective Liners



The electrodes should be slightly moistened approximately once a week.

- Whenever the Orthosis is not on your leg the electrodes should be covered by the cover supplied with the electrodes.

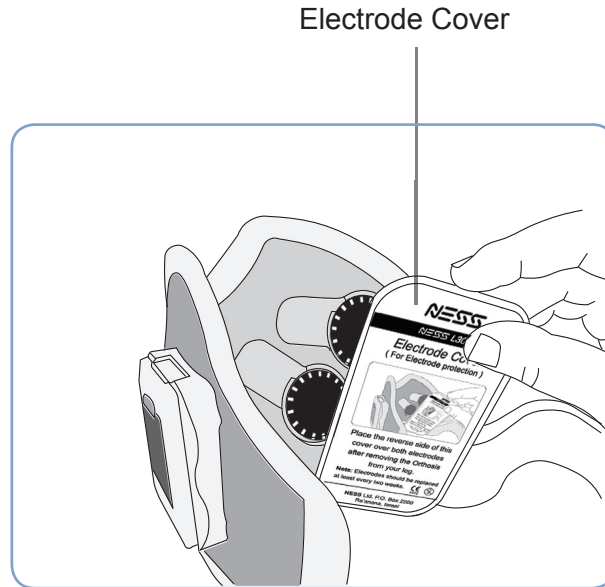

Figure 19: Attaching the Electrode cover

Cleaning your NESS L300™

All parts may be cleaned by carefully wiping with a damp cloth.

Electrical components are not waterproof, so **do not immerse them in water**. The Orthosis is the only component that can be immersed in water for cleaning.

When the Orthosis needs a thorough cleaning:

1. Remove the RF Stim Unit (see "*Removing and Installing the RF Stim Unit*" section).
2. Immerse the Orthosis for 30 minutes into lukewarm water with a small amount of mild detergent.
3. Rinse thoroughly under running water.
4. Immerse the Orthosis for an additional 15 minutes into clean lukewarm water.
5. Rinse again under running water.
6. Let dry in shade (do not hang).

The Orthosis should dry fully in 4 to 12 hours according to climate and humidity.

7. Reattach the RF Stim Unit once the Orthosis is completely dry.





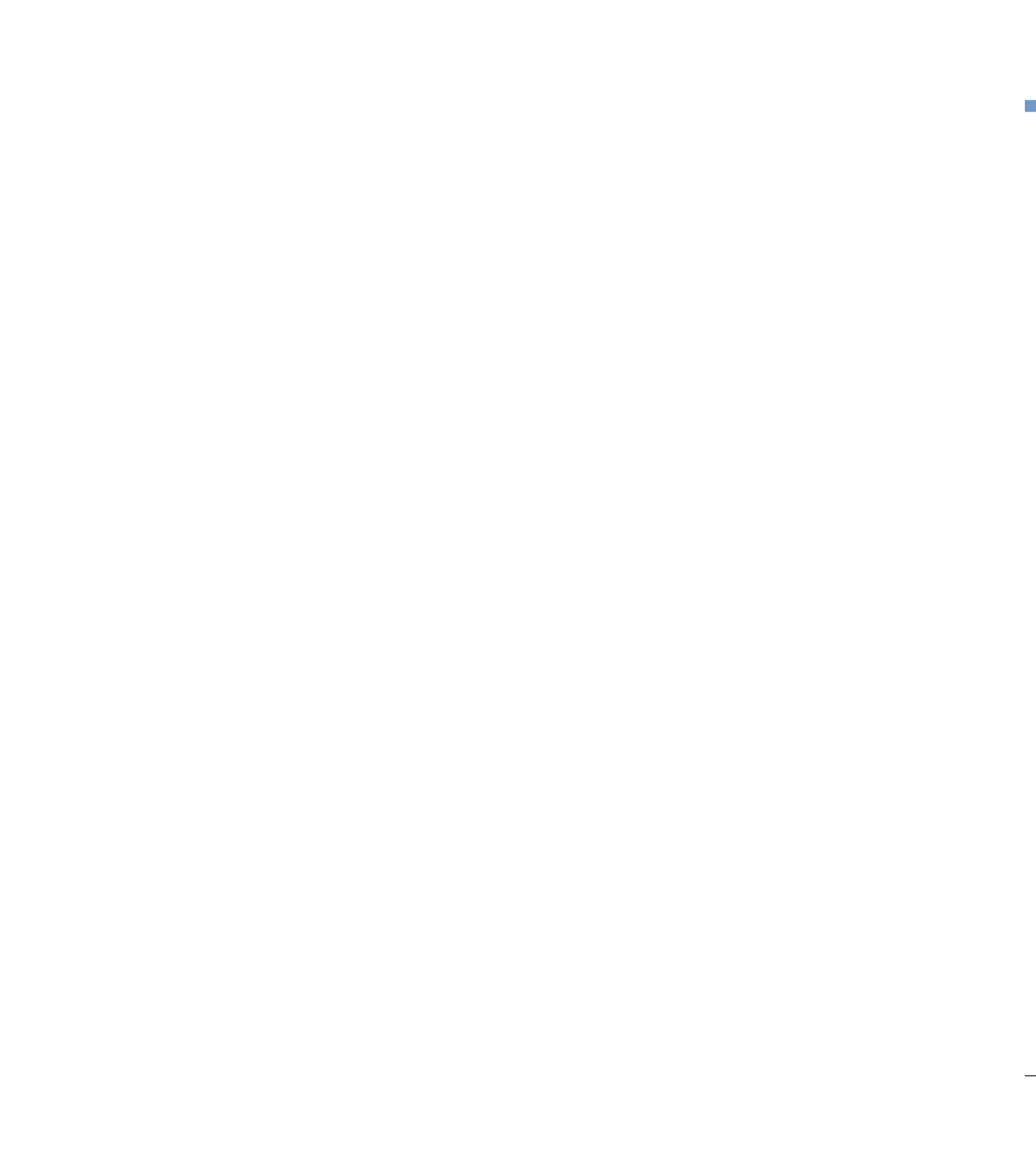

Do not use a washing machine or drier.



Replacing and Installing System Components

Replacing and Registering Components

When one or more of the NESS L300™ electronic components are replaced, it needs to be electronically registered to ensure radio communication between the components of the system. New components that requires registration are:

- Control Unit
 - RF Stim Unit
 - Foot Sensor
1. Make sure the Control Unit is turned OFF.
 2. Press the  and  buttons simultaneously and hold them for 3 seconds.
 3. The Control Unit's display will light up in 2 alternating arches  until the registration is complete (See Figure 20).
 4. If you are registering a new Foot Sensor, you need to apply pressure to the Foot Sensor immediately after entering the registration state.
 5. The letter  (short for connected) will appear on the Control Unit indicating a successful registration.



If the component registered is the RF Stim unit - its status light will turn green.

- The letter “E” (short for Error) will appear if the registration was unsuccessful. In such case, repeat steps 1-3. If the problem persists see the *troubleshooting* section.

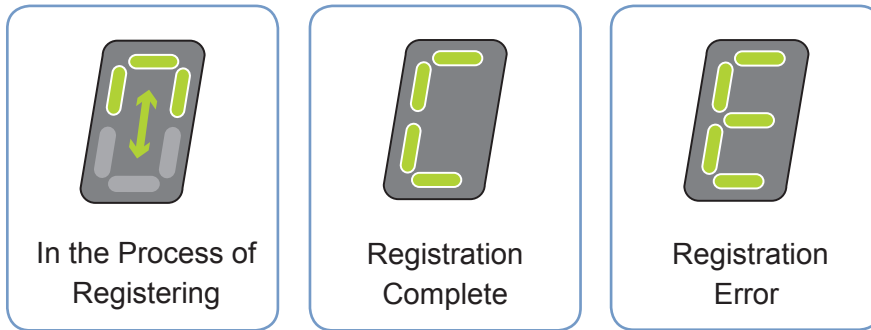

Figure 20: Display while Registering



Multiple Foot Sensors can be registered with one L300™ system, allowing you to use several pairs of shoes without the need to transfer your Foot Sensor from one shoe to another.

Removing and Installing the RF Stim Unit

The RF Stim Unit should be removed only for the purpose of cleaning the Orthosis or for its replacement.

Figure 21 shows how to detach the RF Stim Unit from the Orthosis cradle.

1. Release the RF Stim Unit from the cradle by pulling its upper edge out.
2. To reinstall the RF Stim Unit, insert the bottom prongs into the lower part of the cradle and push its upper part gently into the cradle until a snap sound is heard.

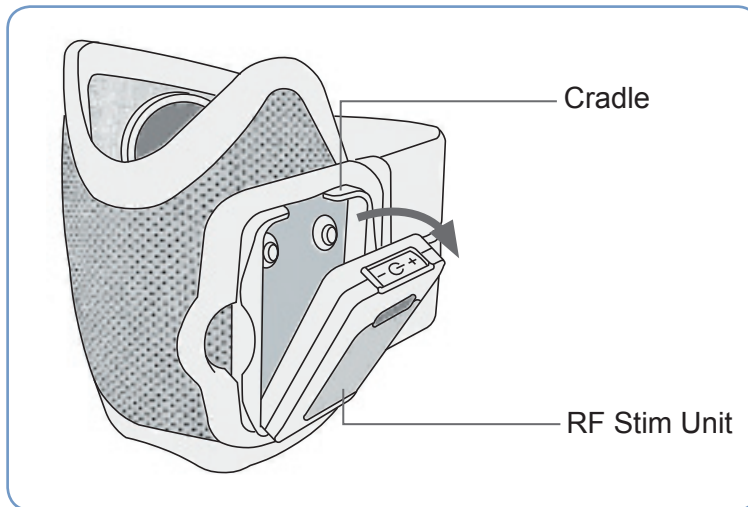

Figure 21: Removing the RF Stim Unit from the Orthosis

Warning: Do not turn the system on while the RF Stim Unit is out of the cradle

Placing a Foot Sensor in your Shoe

The Foot Sensor should be placed under an insole.

1. Remove the insole from the shoe.
2. Stick an adhesive pad (included in the kit) in your shoe in the area directly below your heel.

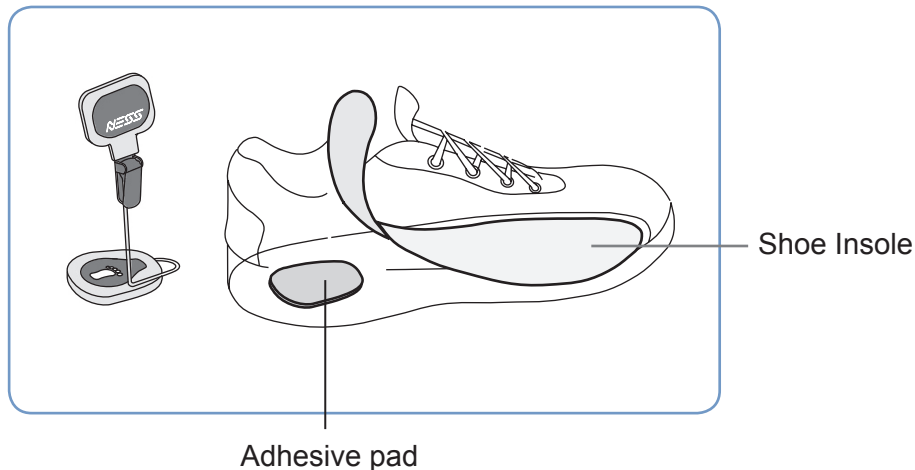

Figure 22: Foot Sensor Adhesive Pad in a Shoe

3. Place the Foot Sensor in the shoe, onto the adhesive pad with the wire pointing towards the toe area (also see the foot image on the sensor for correct alignment).

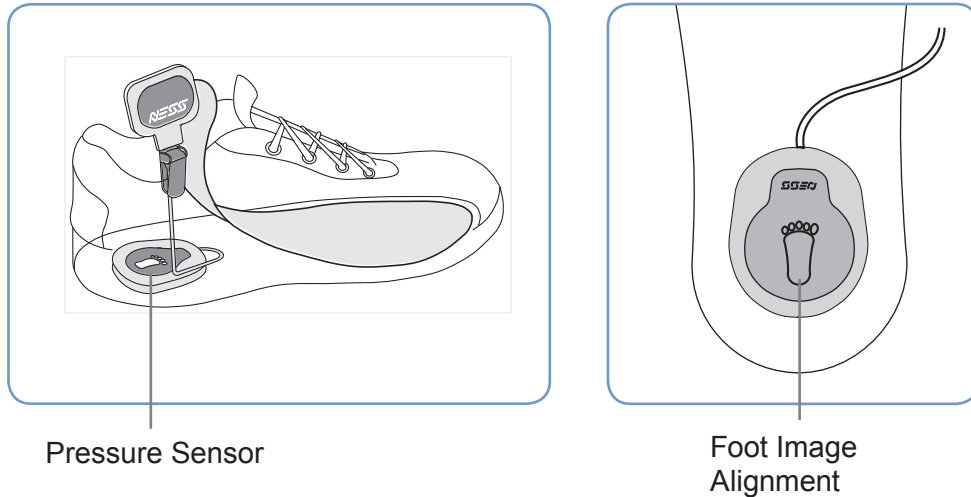

Figure 23: Foot Sensor in Place Under Insole

4. Insert the insole into the shoe to cover the sensor, making sure any excess wire is tucked out of the way under the insole.
5. Attach the transmitter of the Foot Sensor to the inner rim of the shoe using the clamp. The NESS logo on the transmitter should face away from the shoe.

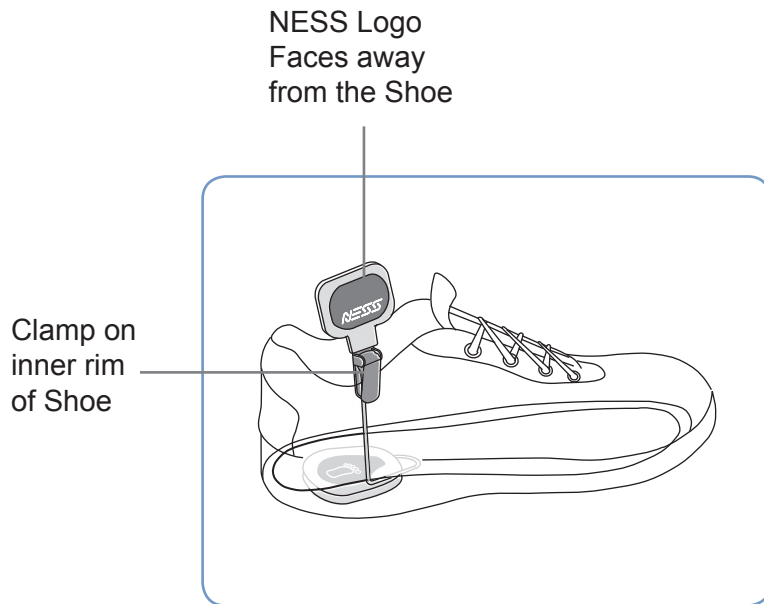

Figure 24: Transmitter in Place (Left Shoe Shown)

Accessories

The NESS L300™ comes with accessories that are designed to help you avoid the inconvenience and distraction of holding your Control Unit.

1. Neck strap (supplied):

The neck strap enables you to hang the Control Unit around your neck. If you find it more convenient you may insert the Control Unit into your shirt pocket.

2. Wrist strap (supplied):

The wrist strap allows you to hang the Control Unit from your hand, or to pull it out of a pocket or pouch easily.

3. Belt pouch:

This small pouch fits on your belt for quick and easy storage of your Control Unit.

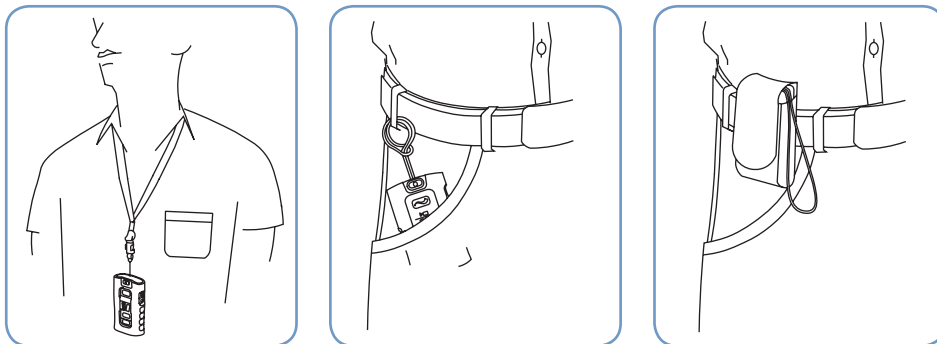
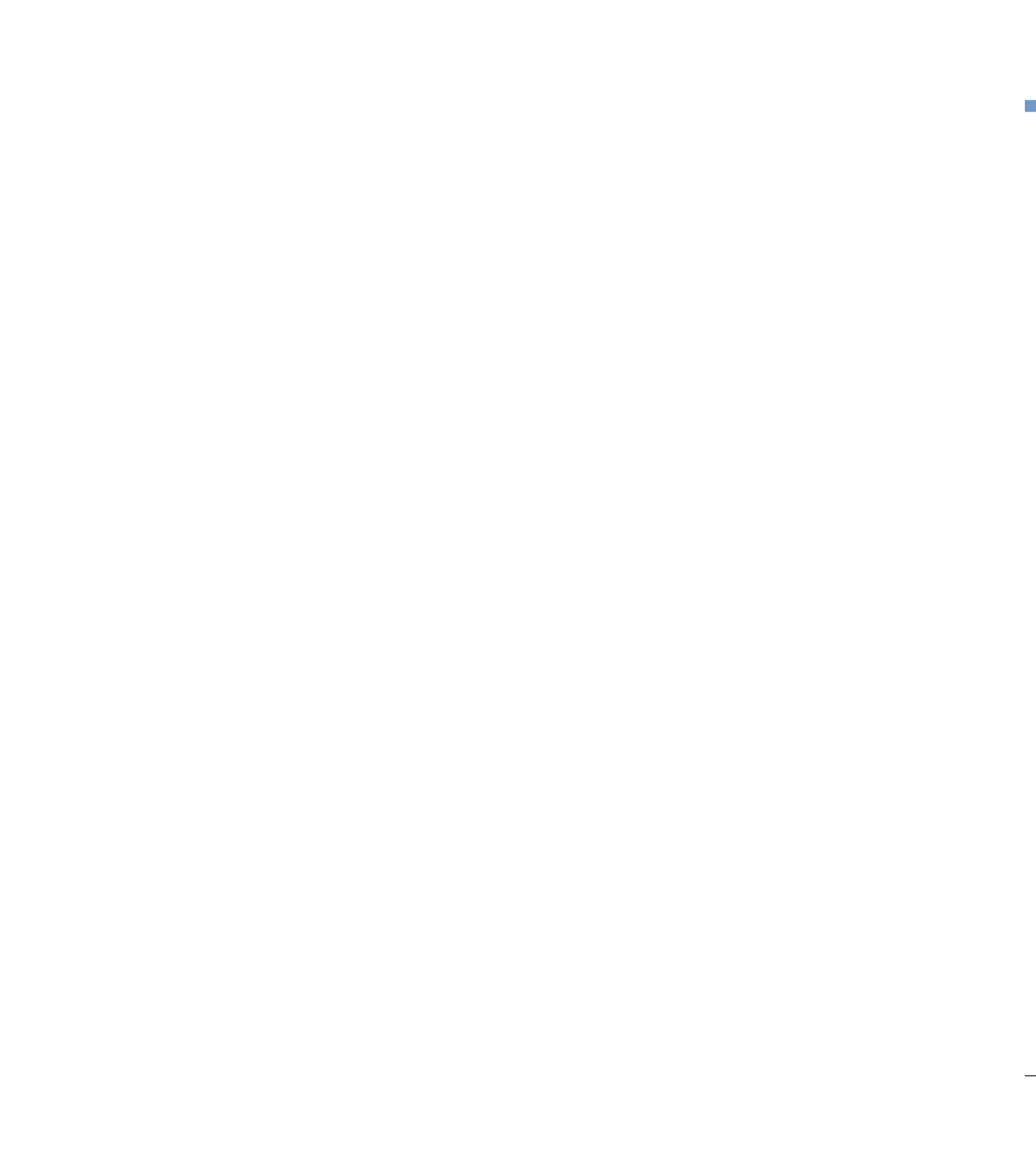

Figure 25: Accessories



Troubleshooting

What should I do if...

...I hear a beep, the RF Stim Unit's indicator on the Control Unit turns red and the letter "E" appears on the intensity display?



This is a symptom of **Bad Electrode Contact**. To resolve this follow these steps:

1. Turn OFF the Control Unit.
2. Remove the Orthosis from your leg.
 - Make sure the electrode liner is removed and there is no interference to the contact between the electrodes and the skin.
 - Make sure that the electrodes are installed properly. The electrodes may be missing or damaged. If this is the case then install new electrodes according to the section "Replacing Electrodes".
3. Put the Orthosis back on your leg, turn the Control Unit ON, and press the Gait mode button.

If the problem persists then:

4. Check that the RF Stim Unit is installed properly (see the section "Removing and Installing the RF Stim Unit").

If the problem persists then contact your NESS L300™ distributor.

What should I do if...

The Control Unit starts to beep, the system stops working, the Control Unit indicators start flashing red in succession and the letter "E" flashes on the intensity display?



This is a symptom of **Radio Communication Failure**. Make sure that all the components are in radio range of each other and their batteries full. The system will not work if all components aren't present or if one of the components isn't working. After making sure that all the components are present and working, turn the system OFF and back ON. If all components are present and working, apply pressure to the Foot Sensor. If the problem persists contact your NESS L300™ distributor.

...one of the component indication lights starts to flash yellow and I hear a beep?

The corresponding **component's battery is low**, and needs charging. If the Foot Sensor's light is flashing - its battery needs to be replaced. (see the sections "Charging the batteries" and "Replacing the batteries").

...one of the component indication lights starts to flash red and I hear a beep?

The corresponding **component is malfunctioning**. Stop using the NESS L300™ and contact your NESS L300™ distributor.

What should I do if...

...during charging the letter "E" appears on the Control Unit display?

An **error occurred while charging**. Try to reconnect the charger cable. If this doesn't help replace the battery or contact your NESS L300™ distributor.

... the Control Unit's display does not light up when I switch it ON?

Make sure that the **Control unit's battery** is charged (see the section "Charging the batteries"). If after charging the battery, the problem persists, replace the battery or contact your NESS L300™ distributor.

...after charging the batteries, they are still low?

Your **batteries need replacing** (see the section "replacing the batteries"). If the RF Stim Unit's battery needs replacing contact your NESS L300™ distributor.

... the electrodes are frayed, peeling, damaged, or falling off the Orthosis?

- Replace **electrodes** (see the section "Replacing Electrodes").
- Your electrode bases may be worn, contact your NESS L300™ distributor.

What should I do if...

...My NESS L300™ is stimulating, but there is no ankle movement or the foot does not move in a satisfactory way.

This is a symptom of **inaccurate positioning of the Orthosis** on the calf. To resolve this follow these steps:

1. Turn OFF the system.
2. Take the Orthosis off your leg.
3. Reposition the Orthosis on your leg while making sure it is placed accurately, as described in the section "Putting on the Orthosis".

If the movement is still unsatisfactory then contact your NESS L300™ distributor.

...stimulation happens in consistently while walking, but no fault indication appears.

This is a symptom of a **technical problem with the Foot Sensor**. The Foot Sensor is either worn out or incorrectly placed in the shoe. Reposition or replace the Foot Sensor accordingly.

...I receive stimulation in training mode but not in gait mode.

Replace the Foot Sensor's battery or Foot Sensor.

Specifications

Control Unit Specifications	
Classification	Internally powered, continuous operation
Operation modes	Gait, Training
Battery type	Rechargeable AAA NiMH 1.2 V, 750 mAh
Controls	On/Off illuminated button Gait mode illuminated button for changing operation modes Intensity +/- buttons to fine-tune the intensity Volume +/- buttons control buzzer volume
Indications	Three status LEDs: Control Unit, RF Stim unit and Foot Sensor. Numerical display designates relative stimulation intensity Illuminated buttons designates system operation mode. Buzzer for audible indications
Carrying	In pocket, Neck strap, Wrist strap, Belt pouch
Dimensions	Height: 71 mm Width: 46 mm Depth: 17.5 mm
Weight	45 grams
Environmental	Transport and storage: 0-35°C (32-95°F) Operating: 0-45°C (32-113°F) Charging: 10-45°C (50-113°F) 10% to 85% relative humidity 900 hPa to 1060 hPa atmospheric pressure

RF Stim Unit Specifications	
Classification	Internally powered, continuous operation with type BF applied parts
Operating voltage	3.7 V
Battery type	Proprietary rechargeable Lilon (Lithium Ion) 3.7 V, 700 mAh
Indications	Status (fault, battery, charging) and Stimulation LEDs Buzzer for audible indications
Dimensions	Height: 76mm Width: 43mm Depth: 14.5mm
Weight	45 grams
Environmental	Transport and storage: 0-35°C (32-95°F) Operating: 0-45°C (32-113°F) Charging: 10-45°C (50-113°F) 10% to 85% relative humidity 900hPa to 1060hPa atmospheric pressure
Pulse Parameters	
Pulse	Balanced Biphasic
Waveform	Symmetric or Asymmetric
Intensity	0 - 80 mA, 1mA resolution (positive phase)
Max Voltage	120 V

	Symmetric			Asymmetric		
Positive phase width	100 μ S	200 μ S	300 μ S	100 μ S	200 μ S	300 μ S
Negative phase width	100 μ S	200 μ S	300 μ S	400 μ S	800 μ S	1200 μ S
Inter-phase interval	50 μ S			0		
Total Pulse duration	250 μ S	450 μ S	650 μ S	500 μ S	1000 μ S	1500 μ S
Max Load	5000 Ω (Subject to Max Voltage limitation)					
Pulse repetition rate	15- 45 Hz (5 Hz resolution)					
Gait Parameters						
Ramp up	0 - 2 seconds, 0.1 second resolution					
Ramp down	0 - 2 seconds, 0.1 second resolution					
Delay	0 - 100% of stance time, 10% resolution					
Max duration	4 seconds					
Training Parameters						
On time	4 - 20 seconds, 1 second resolution					
Off time	4 - 60 seconds, 1 second resolution					
Ramp up	0 - 2 second, 1 second resolution					
Ramp down	0 - 2 seconds, 1 second resolution					
Total time	1 - 60 minutes					

Orthosis specifications	
Orthosis	Fabric-polymer Orthosis for single handed electrode relocation
Limb size	29 - 51 cm limb circumference
Dimensions	Height: 135 mm Width: 100 mm Depth: 125 mm
Weight	Approximately 150 grams

Electrode specifications	
Electrodes	Two, 45 mm reinforced hydro gel electrodes Note: Use only electrodes provided by NESS Ltd.







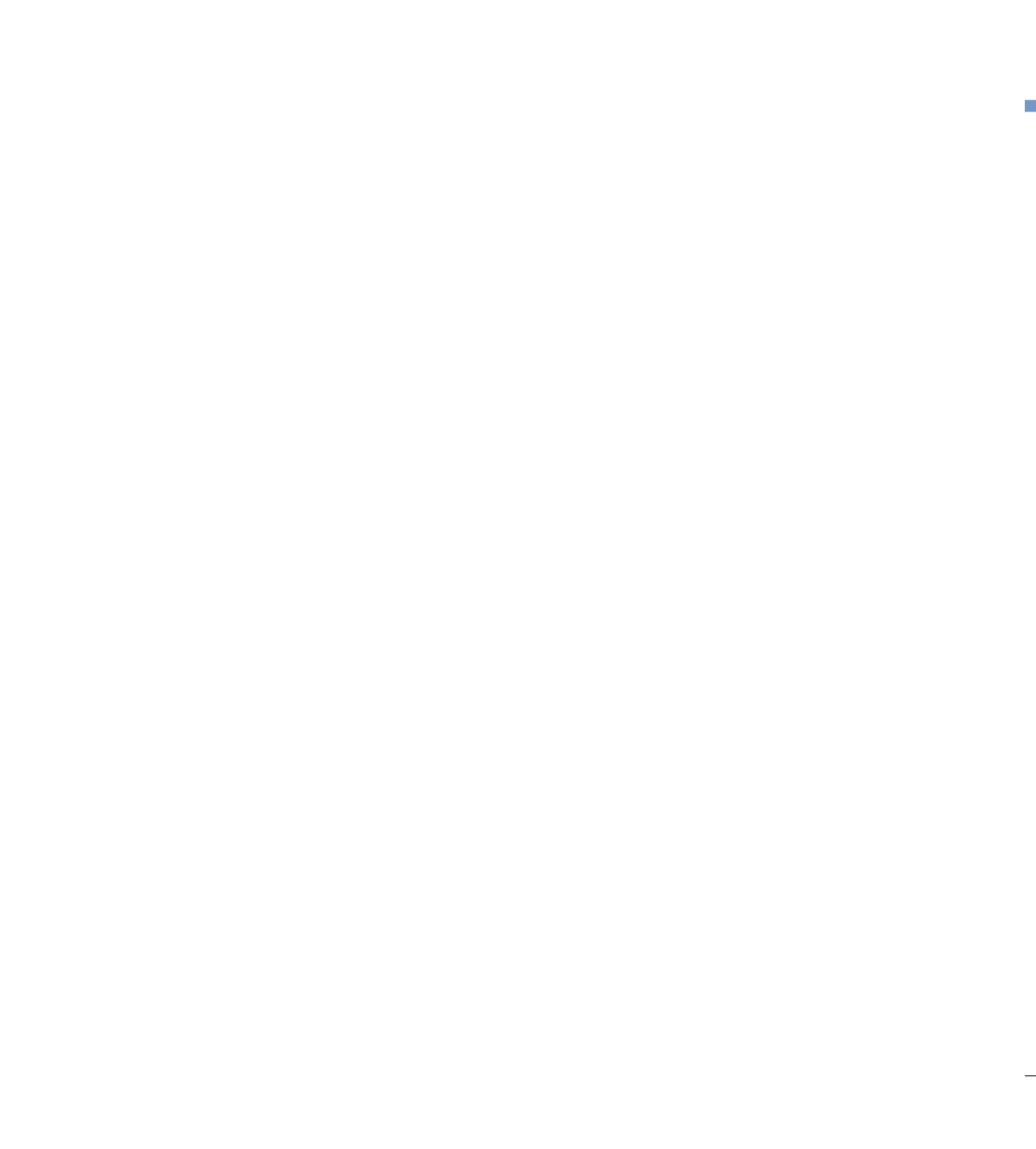



Foot Sensor Specifications	
Classification	Internally powered, continuous operation with type BF applied part
Battery type	Lithium coin cell, CR2430, 280 mAh
Dimensions of the transmitter	Height: 80 mm Width: 50 mm Depth: 10 mm
Weight	35 grams
Environmental	Transport and storage: 0-35°C (32-95°F) Operating: 0-45°C (32-113°F) 10% to 85% relative humidity 900 hPa to 1060 hPa atmospheric pressure

Power Supply specifications (Charger)	
Voltage	5V ± 5%
Current	1300 mA Note: Use only power supply provided/approved by NESS Ltd.

Wireless link specifications	
Frequency band	2.4 GHz, ISM band
Transmission power	Complies with FCC 15.247 (for US) / ETSI EN300-440 (for Europe) Regulations.



List of Symbols

	<p>Attention, See Instructions for Use</p>
	<p>Complies to United States and Canadian product safety standards</p>
	<p>Complies with the European Union medical device directive</p>
	<p>Serial Number</p>
	<p>Class II</p>
	<p>Type BF Applied Part</p>
	<p>Non-Ionizing Radiation</p>
	<p>Authorized European Representative</p>
	<p>Date of manufacture</p>
	<p>Manufacturer</p>
	<p>This product must not be disposed of with your other household waste</p>

