

Preface

Thank you for selecting the GE006 Blood Glucose Monitoring System. This manual provides all the information you need to operate this product for accurate test results. Please read this entire manual before you start any testing.

For people living with diabetes, it is important to regularly monitor blood glucose levels to effectively reduce complications from the disease. The easy-to-use GE006 Blood Glucose Monitoring System provides accurate, reliable test results to help you better manage your diabetes.

The GE006 Blood Glucose Monitoring System is designed for in vitro diagnostic use only (for self-testing by a single user outside the body). Testing requires only a small amount of fresh capillary whole blood from either the fingertip, palm or forearm.

The GE006 Blood Glucose Monitoring System is manufactured and supported by Bionime Corporation. If you have any questions or concerns, please contact your local Bionime Customer Service or call us at 886 0800 241 688 GMT+08:00, 08:30~17:30.

Preface

The GE006 Blood Glucose Monitoring System is a personal blood glucose monitoring system to be used for self-testing only. It is not recommended for multiple users.

A healthcare professional should be contacted when Customer Service is not available.

Caution

- Before using the GE006 Blood Glucose Monitoring System to test your blood glucose, please read all of the instructions and conduct all of the tests including the quality control test (Refer to page 37).
- Please perform the quality control test regularly to make sure the test results are accurate.
- The GE006 Blood Glucose Meter can only be used with GE006 Blood Glucose Test Strips. Other brands' test strips should not be used under any circumstances. The use of other brands' strips may give inaccurate results.
- The GE006 Blood Glucose Monitoring System is intended for in vitro diagnostic use only. The GE006 Blood Glucose test results using fresh capillary whole blood samples from the fingertip, palm and forearm are calibrated to be the equivalent to that of plasma testing.
- The GE006 Blood Glucose Monitoring System is intended for self-testing. It should not be used to screen for or diagnose diabetes mellitus.
- If the GE006 Blood Glucose Meter and Test Strips are exposed to a substantial change in temperature, please wait 30 minutes before measurement.
- Follow all environmental protection regulations when disposing of batteries.
- Avoid contact with dripping or splashing liquids.
- The minimum blood sample size to test using the GE006 Blood Glucose Monitoring System is 0.75µL:
(•)

Precaution

Sample Size Example



Blood sample size above 3.0µL might contaminate the test strip port and the meter.

Blood sample size below 0.75µL may cause an inaccurate result or may prevent a meter reading. An Er4 reading will be displayed if the sample size is too small. In this case, repeat the test with a new test strip.



Important Safety Notes:

- The GE006 Blood Glucose Meter and Lancing Device are for single patient use. Do not share them with anyone including other family members.
- All parts of the kit are considered biohazardous and can potentially transmit infectious diseases, even after following the cleaning and disinfecting procedures. Please refer to the section "Cleaning and Disinfecting Procedures" on page 47.
- Users should wash their hands thoroughly with soap and water before and after handling the meter, lancing device, or test strips.

Table of Contents

About the GE006 Blood Glucose Monitoring System	
The GE006 Blood Glucose Monitoring System	8
The GE006 Blood Glucose Meter	10
The GE006 Blood Glucose Test Strip	14
Before Testing	
Meter Activation and Battery Change	16
Setting Up Your Meter - Setting the Date, Time and Volume	18
Turning On/Off the Meter	21
Turning On/Off the Bluetooth	22
Handling the GE006 Blood Glucose Test Strip	23
Testing Procedure	
Getting Ready for Testing	25
Performing a Blood Glucose Test	26
Setting Markers	31
Alternative Site Testing	32
View Window Appearance	34
Understanding Test Results and Messages	35
Quality Control	
About Quality Control Testing	37

Table of Contents

Performing a Quality Control Test	40
Understanding Control Test Results	42
Test Memory	
Recalling Test Results	43
Recalling Average Test Results	45
Caring for Your Meter	46
Cleaning and Disinfecting Procedures	47
Error Messages and Troubleshooting	51
Limitations	55
Real Time Synchronize	56
FEDERAL COMMUNICATIONS COMMISSION (FCC) STATEMENT.....	58
NCC 警語	60
Specifications	61
Warranty	63
Customer Service	64
Expected Blood Glucose Values Without Diabetes	65
Component Manufacturer Information	66
Log Book	67
Warranty Card	82
Emergency Card	85

The GE006 Blood Glucose Monitoring System

Contents

Your GE006 Blood Glucose Monitoring System consists of several items. Please identify each item, learn its name and how it is used.

Below are the items included in your GE006 Blood Glucose Monitoring System:

1. Getting Started Guide *
 2. User's Manual (includes Log Book, Warranty Card, Emergency Card) *
 3. GE006 Blood Glucose Test Strip Package Insert *
 4. **Rightest**® Control Solution GC550 Package Insert *
 5. GE006 Blood Glucose Meter (with 2 AAA batteries installed)
 6. GE006 Blood Glucose Test strips (10/25 pcs) *
 7. **Rightest**® Control Solution GC550 *
 8. **Rightest**® GD500 Lancing Device *
 9. Clear Cap *
 10. Disposable Sterile Lancets (10 pcs) *
 11. Carrying Case (not shown) *
 12. Instruction for the lancing device (not shown) *
- (* Different packages have different bundled items. Some of packages might not include * items.)

The GE006 Blood Glucose Monitoring System

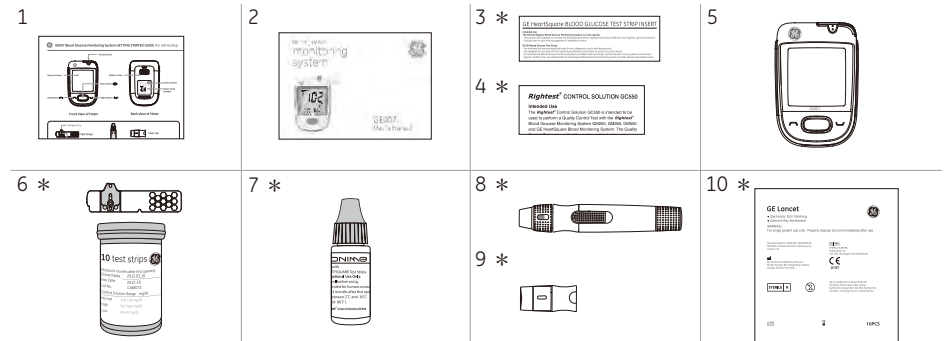

If you want to purchase optional items, please contact the Customer Support Center at 866-0800-241-688.

The GE006 Blood Glucose Meter

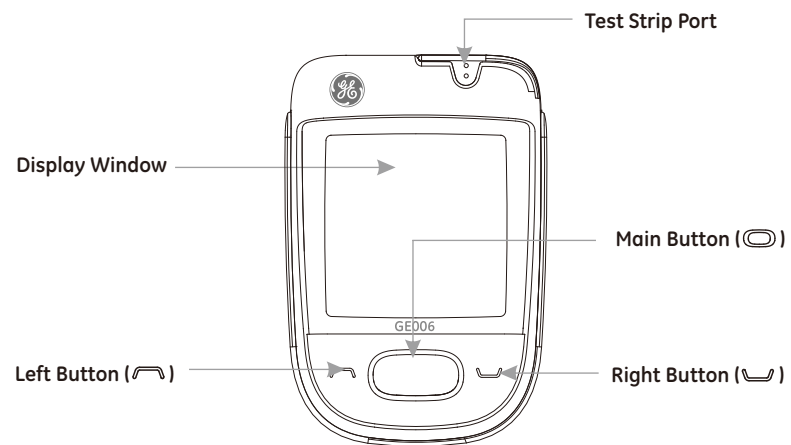

10

The GE006 Blood Glucose Meter

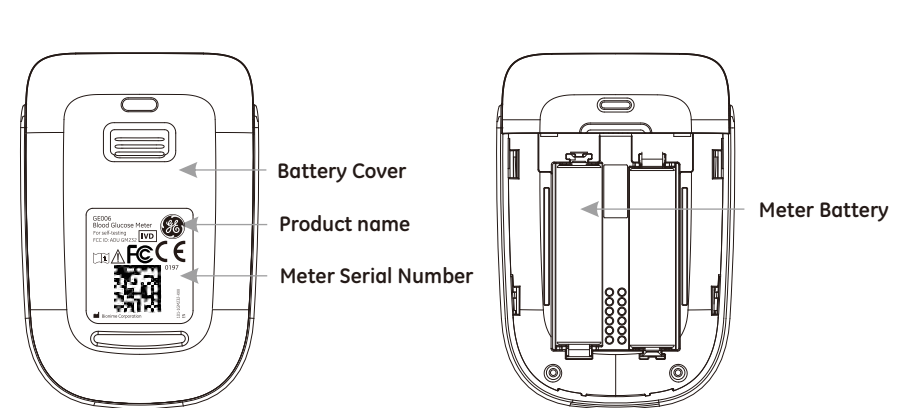

11

The GE006 Blood Glucose Meter

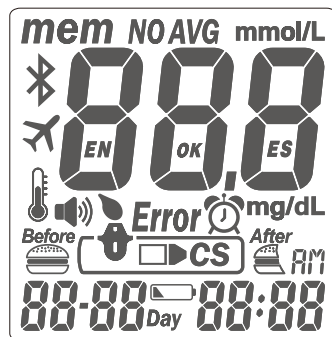

The GE006 Blood Glucose Meter

mem	Indicates a test result stored in memory		Indicates when to apply the blood sample
NO AVG	Indicates a test result not included into the Average function of this meter		Appears after you insert test strip into meter
AVG	Indicates the average result	Error	Appears when an error occurs
	Indicates a control solution test result	00:00	Current date under time mode or testing date under memory mode
mmol/L mg/dL	Unit of test result		Warns when the operational temperature limit is exceeded during testing
000	Test result	AM	Indicates the time in 12H format
	Warns when the battery is low or must be replaced	00:00	Displays current time under time mode or testing time under memory mode
	Indicates a meal marker with test result		Indicates that the Bluetooth is turned off
	Indicates that the Bluetooth is turned on	Day	Indicates the time period of test results
EN OK ES Manufacturing use only			

The GE006 Blood Glucose Test Strip

The GE006 Blood Glucose Meter can only be used with GE006 Blood Glucose Test Strips and **Rightest™** Control Solution GC550. The use of other test strips or control solutions can lead to incorrect results.

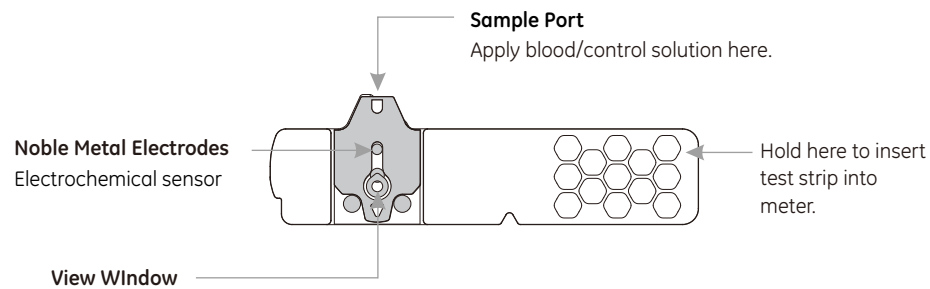

The GE006 Blood Glucose Test Strip

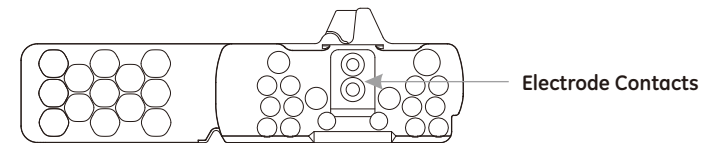

PRECAUTION

- Close the GE006 Blood Glucose Test Strip vial immediately after removing a test strip.
- Do not reuse GE006 Blood Glucose Test Strips.
- Do not use expired GE006 Blood Glucose Test Strips.
- When you open a new vial of GE006 Blood Glucose Test Strips, record the date on the vial. Discard the vial of test strips after 3 months from opening.
- Store the GE006 Blood Glucose Test Strip between 4-30°C (or 39-86°F) and in a location (< 90% relative humidity). Do not expose to direct sunlight or heat.
- If the GE006 Blood Glucose Meter and Test Strips are exposed to a substantial change in temperature, please wait 45 minutes before measurement.
- For detailed information, please refer to the GE006 Blood Glucose Test Strip Package Insert.

Meter Activation and Battery Change

Your GE006 Blood Glucose Meter comes with two AAA, batteries installed. Two new batteries will provide power to perform approximately 800 tests under normal use with one data transfer. Press the main button or insert a strip to activate your meter.



1. Turn the GE006 Blood Glucose Meter over. Press and slide the battery cover to open.

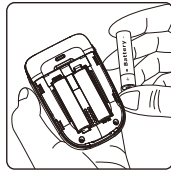

2. Install the batteries. Be sure to put the batteries in the correct direction.

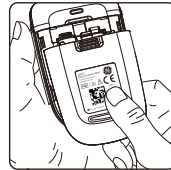

3. Slide the battery cover back until it snaps into place.

4. The GE006 Blood Glucose Meter will enter Self-Testing Mode automatically when replacing the battery (all symbols will appear on the screen).

5. Press any button to exit the self-test and enter Setting Mode.

6. You must set the time and date when replacing the battery. See Chapter "Setting Up Your Meter - Setting the Date, Time, and Volume" on page 18. Test results are still stored in the memory.

CAUTION

- Please follow the local regulation to properly discard a used battery.
- Risk of explosion if battery is replaced by an incorrect type.

Meter Activation and Battery Change

You can enter the Setting Mode two ways.

1. Replace the Battery

After removing the battery, press the main button several times until there is no signal on screen, then follow the battery installation steps to replace battery. The GE006 Blood Glucose Meter will perform a self-test. Press the main button to exit the self-test and enter the Setting Mode.

2. With Battery Inserted

Press the main button to turn on the GE006 Blood Glucose Meter. Hold down the main button for 7 seconds. During this time the screen will go blank until you hear a beep. After the beep, the meter will turn on into the Setting Mode. The display screen will show setting data.



NOTE

- Use the Left and Right buttons to select your setting data and press the main button to confirm each selection. After confirming all of the settings, you will return to the Time Mode.

Setting Up Your Meter - Setting the Date, Time and Volume

1. Year setting

With the year format blinking, press the Left or Right button until you see the current year. Press the Main button to confirm. Once the year is confirmed, the Month Setting will appear.

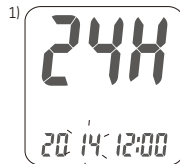

2. Month setting

With the month blinking, press the Left or Right button until you see the current month. Press the Main button to confirm. Once the month is confirmed, the Day Setting will appear.

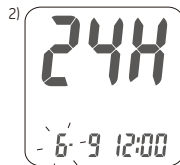

3. Day setting

With the day blinking, press the Left or Right button until you see the current day. Press the Main button to confirm. Once the day is confirmed, the Time Setting will appear.

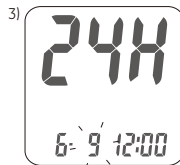

Setting Up Your Meter - Setting the Date, Time and Volume

4. Time format 12/24H selection

With the time format blinking, press the Left or Right button to switch between 12H and 24H. Press the Main button to confirm. Once confirmed, the Hour Setting will appear.

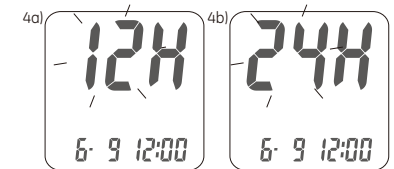

5. Hour setting

With the hour blinking, press the Left or Right button until you see the current hour. Press the Main button to confirm. Once the hour is confirmed, the Minute Setting will appear.

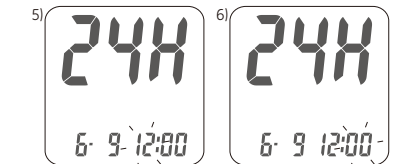

6. Minute setting

With the minutes blinking, press the Left or Right button until you see the current minute. Press the Main button to confirm. Once the minute is confirmed, the Volume Setting will appear.

Setting Up Your Meter - Setting the Date, Time and Volume

Turning On / Off the Meter

7. Volume Setting

With the volume blinking, press the Left or Right button to turn the volume on or off. Press the Main button to confirm and finish the settings.

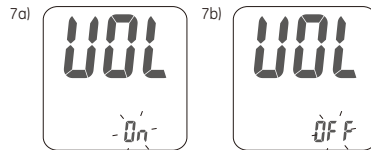

8. Setting the Unit of Measurement

With milligrams per deciliter (mg/dL) or millimoles per liter (mmol/L) blinking, press the Left or Right button to switch. Then press the Main button to confirm it and finish the settings.

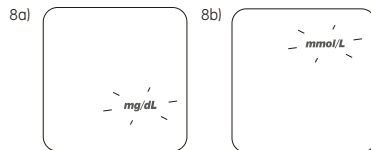

9. Ending setting

After measurement of unit setting, for confirmation you will hear a beep (if volume is turned on). All the settings are saved and completed and will return to time screen.

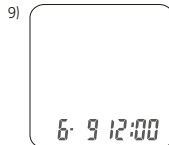

1. How to turn on the GE006 Blood Glucose Meter

Press the Main button or Insert a test strip.

2. Manual Power off

To power off the GE006 Blood Glucose Meter, press and hold the Main button for 4 seconds.

3. Auto Power off

The GE006 Blood Glucose Meter will power off automatically after 2 minutes if no buttons are pressed or no strip is inserted.

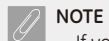

NOTE

- If you do not change any settings during Meter Set-up for over 2 minutes, the GE006 Blood Glucose Meter will leave setting mode and power off automatically.

Turning On/ Off the Bluetooth

1. Auto turn on the Bluetooth

After leaving the Setting mode, the Bluetooth will turn on automatically and the "📶" symbol blinks on the screen.

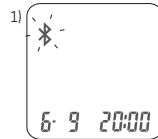

2. Turn off the Bluetooth

In Time mode, press and hold the Right or Left button for two seconds. The blinking "📶" symbol will switch to the "✈️" symbol with a beep (If Volume is turned on).



3. Manual turn on the Bluetooth

In Time mode, press and hold the Right or Left button for two seconds. The "✈️" symbol will switch to the blinking "📶" symbol with a beep (If Volume is turned on).

NOTE

1. The blinking "📶" symbol should turn to steady immediately when the Bluetooth connection is established.
2. Blinking back and forth "↔️" symbol on the screen means the meter is transferring data.



Handling the GE006 Blood Glucose Test Strip

How to handle the GE006 Blood Glucose Test Strip.

Inserting the GE006 Blood Glucose Test Strip:

1. Hold the GE006 Blood Glucose Test Strip between your thumb and middle finger with the view window "👁️" facing up.
2. Put your forefinger on the side of the strip as shown.
3. Insert the GE006 Blood Glucose Test Strip into test strip port until it clicks and firmly stops.

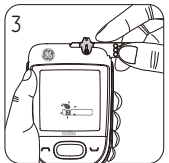
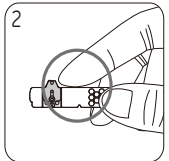
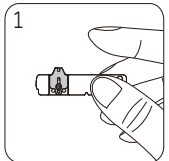

Handling the GE006 Blood Glucose Test Strip

Removing the GE006 Blood Glucose Test Strip:

1. Hold the GE006 Blood Glucose Test Strip as shown.
2. Rotate the GE006 Blood Glucose Test Strip counterclockwise and pull up simultaneously.
3. Take the GE006 Blood Glucose Test Strip out of the test strip port. Please follow your health care professional's direction and discard used strips properly.

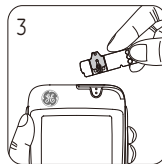
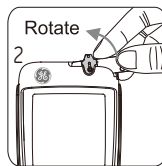
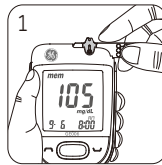

Before performing a blood glucose test, prepare the items below :

- GE006 Blood Glucose Meter
- GE006 Blood Glucose Test Strips
(Please check the expiration date on the test strip vial. Do not use expired test strips)
- **Rightest™** GD500 Lancing device
- Sterile lancet
- Alcohol swab (optional)

Getting Ready for Testing

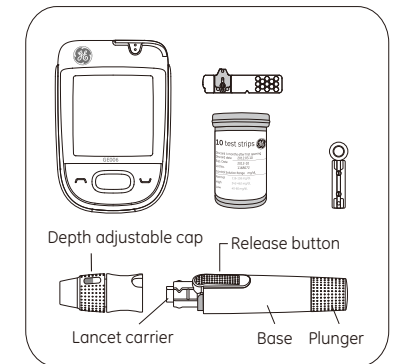

Performing a Blood Glucose Test

1. Hold the depth adjustable cap in one hand and hold the base with the other hand. Bend the cap down. When a gap appears between the cap and base, pull the cap and base in opposite directions.
2. Pull off the depth adjustable cap.
3. Insert a new disposable lancet firmly into lancet carrier.
4. Twist off and set aside the protective cover of the disposable lancet.
5. Replace the depth adjustable cap.
6. Choose a depth of penetration by rotating the top portion of the depth adjustable cap until your desired setting is visible in the window. Settings are based on skin type: " " for soft or thin skin; " " for average skin; " " for thick or calloused skin.

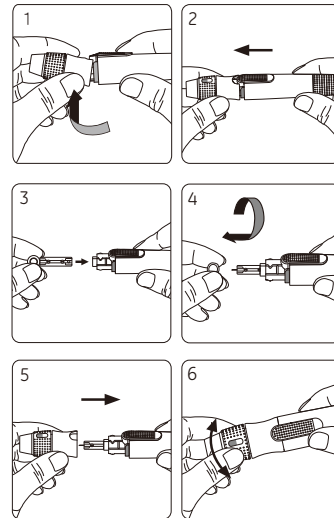

Performing a Blood Glucose Test

7. Hold the base in one hand and pull on the plunger with the other hand. The device will be cocked. Release the plunger and it will automatically move back to its original position near the base.
8. Wash your hands with warm soapy water and dry thoroughly.
9. Take one GE006 Blood Glucose Test Strip from the vial. Close the vial cap immediately.
10. Insert the strip into the test strip port of the GE006 Blood Glucose Meter with the view window facing up.
11. Once the strip is inserted, all symbols will appear on your meter display and will be accompanied by a beep (if volume is turned on).

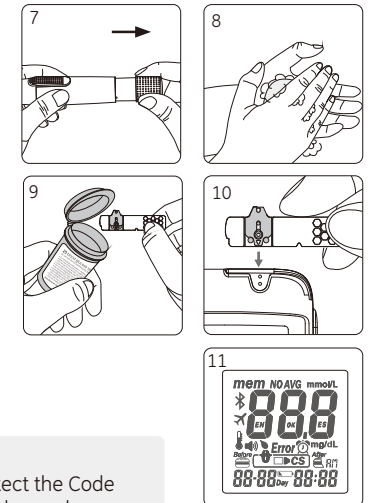

NOTE

- The GE006 Blood Glucose Meter will automatically detect the Code number on the strip. You do not have to check the Code number on the meter display and strip vial.

Performing a Blood Glucose Test

12. A blood drop icon will appear on the display window and will be accompanied by a beep (if volume is turned on). Apply the blood sample within 2 minutes.
13. Place the lancing device against your fingertip and press the release button.
14. Touch and hold the blood drop to the edge of sample port until the view window is filled with blood. If the view window is not completely filled with blood the test will not start. If the blood sample was insufficient, discard the test strip and repeat with a new GE006 Blood Glucose Test Strip.
15. Countdown Mode will begin on the display window. After 5 seconds, your test result will appear.

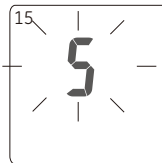
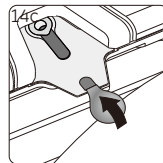
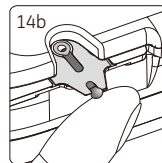
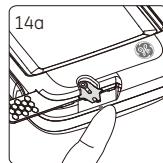
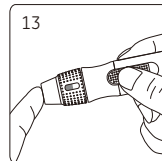
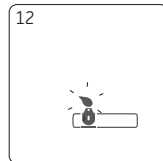

Performing a Blood Glucose Test

16. Pull off the depth adjustable cap. Without touching the used disposable lancet, insert the lancet tip into the protective lancet cover.
17. Hold the release button in one hand (see picture 17, step 1) and pull on the plunger with the other hand (see picture 17, step 2) to safely eject the used disposable lancet.
18. Discard the used disposable lancet into an appropriate puncture-proof or biohazard container.
19. Replace the depth adjustable cap after finishing the test.

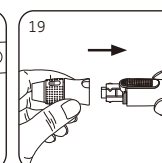
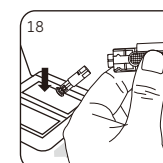
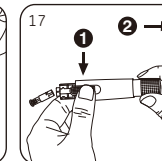
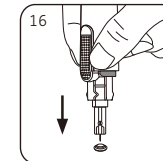

Performing a Blood Glucose Test



CAUTION



- Do not apply your blood drop to the sample port on the strip until you see the " " appear. The GE006 Blood Glucose Meter is performing an internal test and will display " " and " **Error** " if you apply blood too soon. If this occurs, please repeat the test with a new test strip.
- Record the opening date of a new test strip vial. Discard the vial of test strips 3 months after opening.
- Always keep the metal contacts of the test strip port clean. If any dust or impurities are present, please clean with a small, soft brush.
- The GE006 Blood Glucose Monitoring System and **Rightest™** GD500 Lancing Device are intended for a single user only. Do not share these devices with anyone, including other family members.
- All parts of this kit are considered biohazards and can potentially transmit infectious diseases, even after you have performed the cleaning and disinfecting procedure.
- Users should wash hands thoroughly with soap and water after handling the meter, lancing device, and test strips.
- Please refer to the section "Cleaning and Disinfecting Procedures "on page 47 for cleaning and disinfecting instructions.





Setting Markers

According to actual life status, you can set meal markers with test result.

You have to perform meal marker setting immediately after the meter displays the reading of your test result.

1. After test, the test result is displayed on the screen with time, date and flashing "  ".
2. Press the Right or Left button to choose among "  " (before meal), "  " (after meal), " " (no marker) and " **NO AVG** ". Then press the Main button to confirm and save this record.

	Before meal: You execute this blood glucose test before a meal.
	After meal: You execute this blood glucose test after a meal.
	(Blank) no marker: regular test or definition by user.
NO AVG	No average: You will exclude this test result from average calculation. Please refer to "Excluding test results from the average calculation "on page 45 for more information.



NOTE

If no button pressed, the marker will be set blank automatically after 15 seconds.

Alternative Site Testing

Alternative site testing: palm or forearm blood sampling

- To perform alternative site testing, install the clear cap for your **Rightest™** GD500 Lancing Device.
(For detailed information, refer to the instruction manual for the **Rightest™** GD500 Lancing Device.)
- To increase the blood flow, massage the intended puncture area of your palm or forearm for a few seconds.
- Immediately after massaging the intended puncture area, press and hold the lancing device with the clear cap against palm or forearm.
- Press the release button.
- Continue holding the lancing device against your palm or forearm and gradually increase pressure for a few seconds until the blood sample size is sufficient. (DO NOT test on the palm or forearm if you are testing for hypoglycemia (Low blood glucose).

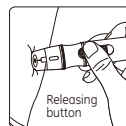
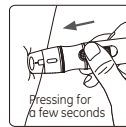
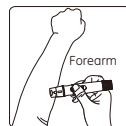

Alternative Site Testing



CAUTION

- Test results may vary if blood samples are taken from different sites or under certain conditions where glucose levels are changing rapidly such as: following a drink, a meal, an insulin dose or exercise. In these cases, only the fingertip should be used.
- DO NOT test on the palm or forearm if you are testing for hypoglycemia (Low blood glucose).
- Fingertip samples can show the rapid change in glucose faster than palm or forearm samples.
- Consult your healthcare professional before sampling from your palm or forearm.
- Since the blood flow in the forearm and palm is slower than in the fingertip, use the clear cap provided with the **Rightest™** GD500 Lancing Device when testing sites other than fingertip.
- If you use the normal lancing device for your palm or forearm, the blood sample may not be sufficient for meter operation.
- Periodically compare the test system to a laboratory test system that is known to be well maintained and monitored by a healthcare provider.

View Window Appearance

Make sure your blood sample covers the whole area of the view window to get an accurate test result. An insufficient blood sample will result in an error message ("Er4"). If this occurs, repeat the test with a new test strip.

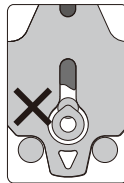

Insufficient blood sample

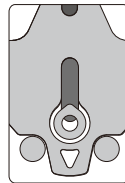

Sufficient blood sample

CAUTION

- Check the expiration date printed on the strip vial every time you use a test strip. Do not use expired GE006 Blood Glucose Test Strips.
- Use each GE006 Blood Glucose Test Strip immediately after removing it from the vial.
- Do not reuse GE006 Blood Glucose Test Strips.
- Do not perform testing immediately after moving from one ambient temperature to another (e.g. after coming indoors from the outside). Allow 45 minutes for the temperature of the meter and the test strips to equilibrate.
- Apply the blood sample only on the sample port of the test strip.

Understanding Test Results and Messages

If your blood glucose result is unusually high or low, or if you question your test results, repeat the test with a new GE006 Blood Glucose Test Strip.

You can also run a Quality Control Test with the **Rightest™** Control Solution GC550 to check your GE006 Blood Glucose Meter and GE006 Test Strip (Refer to "Performing a Quality Control Test" on page 40).

If the test result still remains unusually high or low, contact your healthcare professional immediately.

If you are experiencing symptoms that are not consistent with your blood glucose test results and you have made sure to follow all instructions in this manual, contact your healthcare professional immediately.

Consult your health care provider for appropriate disposal of used test strips and lancets.

Understanding Test Results and Messages

The GE006 Blood Glucose Meter displays results between 10 and 600 mg/dL.

If the test result is below 10 mg/dL, "Lo" will appear on the screen. Please repeat your test with by a new test strip.

If you still get a "Lo" result, contact your healthcare professional.

If the test result is above 600 mg/dL, "Hi" will appear on the screen. Please repeat your test again with a new test strip.

If you still get a "Hi" result, contact your healthcare professional.

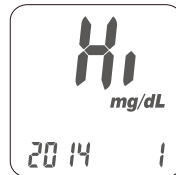
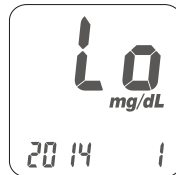

About Quality Control Testing

What is a Quality Control Test ?

To ensure proper monitoring function, it is necessary to regularly perform a quality control test. Use one of the **Rightest™** Control Solution GC550 when testing your GE006 Blood Glucose Monitoring System in the Control Solution Mode. If the test result is within the Control Solution Range printed on the strip vial label, the GE006 Blood Glucose Monitoring System passes the Quality Control Test and your GE006 Blood Glucose Monitoring System is working properly.

Control Solution Range:

Example of Control Solution Range printed on your test strip vial label.

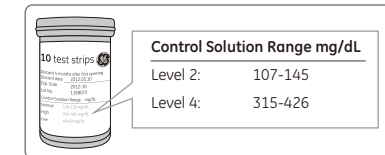

NOTE

- Level 2 of **Rightest™** Control Solution GC550 is provided in your starter kit. If you want to purchase Level 4 or another Level 2 control solutions, please contact Bionime Customer Service at 886 0800 241 688.

About Quality Control Testing

When should a Quality Control Test Be Performed ?

- To ensure that your GE006 Blood Glucose Meter and GE006 Blood Glucose Test Strip are working properly.
- To confirm that you are following the correct testing procedures.
- To prepare for your initial blood glucose test.
- To check the GE006 Blood Glucose Test Strip when you open a new vial of strips.
- To check your GE006 Blood Glucose Meter after it has been dropped, damaged or exposed to liquids.
- If you suspect that your test results are inaccurate, or if your test results are not consistent with the way you feel.
- To practice testing.

Required Items for Quality Control Tests

To perform a quality control test, prepare the items below :

- GE006 Blood Glucose Meter
- GE006 Blood Glucose Test Strips
- **Rightest™** Control Solution GC550

About Quality Control Testing



CAUTION

- Each time you open a new bottle of control solution, write the expiration date on the label. The **Rightest™** Control Solution GC550 is good for 3 months after opening the bottle, or until the expiration date printed on the label, whichever comes first.

Example



- Wipe the bottle cap with a clean tissue before tightly closing the bottle of control solution.
- Close the bottle of control solution tightly immediately after using.
- Check the expiration date before use. (Refer to the **Rightest™** Control Solution GC550 Package Insert).
- Keep control solution bottles out of reach of children.

Performing a Quality Control Test

1. Take one GE006 Blood Glucose Test Strip from the vial and close the vial cap immediately.
2. Insert the GE006 Blood Glucose Test Strip horizontally (not vertically) with the colored view window facing up into the test strip port.
3. While the blood drop icon is flashing on the display window, press and hold the Main button for at least 3 seconds until the "CS" symbol appears.
4. You will see the blinking "CS" icon and "CS" icon on the screen, prompting you to apply **Rightest™** Control Solution GC550.
5. Shake the bottle of **Rightest™** Control Solution GC550 well before opening the cap. Place the cap on a flat surface.
6. Place a drop of control solution onto the top of the cap.
7. Gently touch the sample port of the strip with the control solution from the top of the cap.
8. The screen will display the count time starting from 5 (you will hear a beep if the volume is turned on).

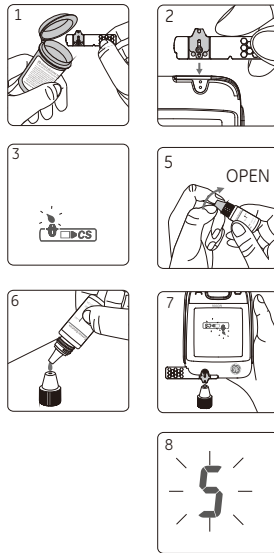

Performing a Quality Control Test

9. Tightly replace the cap on the **Rightest™** Control Solution GC550 bottle.
10. The control solution result will appear. Compare your Quality Control Test result to the Control Solution Range printed on the GE006 Blood Glucose Test Strip vial label.



CAUTION

- Your Control Solution Test results will not be included in the average calculations, however, they can still be recalled and viewed. The Control Solution Test result will be shown with the "CS" icon on the screen.
- The Control Solution Test should be conducted between 15-40°C (59-104°F).
- Before "CS" and "CS" appear, do not touch the control solution to the sample port on the strip. The GE006 Blood Glucose Meter is performing an internal check. Touching the control solution to the sample port before prompted will result in an error message: "Error" and "CS" and be accompanied by beeps (if volume is turned on).
- Do not drip the control solution on to the sample port of the test strip directly. The reagent on the strip might leak into the bottle of control solution and may cause the degeneration of the control solution. This could contaminate the meter via the test strip port.
- Keep the test strip port clean and dry. Clean immediately if the test strip port is stained or is overly exposed to moisture.
- Do not touch the tip of the control solution bottle. If the tip is touched, clean with water.



Understanding Control Test Results

Your control solution test results should fall within the control solution range. If the results are within the range, the GE006 Blood Glucose Monitoring System is working correctly.

Control Solution Range	
Level 2	Level 4
88~120 mg/dL	250~340 mg/dL

Possible reasons your Control Solution results are out of the range :

- Your **Rightest™** Control Solution GC550 is expired or was first opened more than 3 months ago.
- Your GE006 Blood Glucose Test Strip has expired.
- You left the cap of the Blood Glucose Test Strip vial or the control solution off for a period of time.
- You did not perform the test procedure correctly.
- The GE006 Blood Glucose Meter or GE006 Blood Glucose Test Strip have malfunctioned.

If **Rightest™** Control Solution GC550 results are out of range, your GE006 Blood Glucose Monitoring System may not be working properly. Repeat the Quality Control Test. If your control solution results are still out of range, do not use GE006 Blood Glucose Meter to test your blood glucose. please contact Bionime Customer Service at 886 0800 241 688.

Recalling Test Results

The GE006 Blood Glucose Meter is able to automatically store a maximum of 500 test results with time and date. If your meter has stored 500 results, the newest test result will replace the oldest one.

To recall your test memory, start the meter without a test strip inserted.

1. Press the Main button to switch from the Time Mode to Memory Mode. You will see the "mem" icon in the upper left corner of the display. The latest test result will appear with the number "1".
2. Use either the Left or Right button on the side to review all previous results with date and time. Results display from the most recent (Sequence no. "1") to the oldest (Sequence no. "500") in the lower right hand corner of the screen.
3. The Quality Control Test result can be recalled from the saved data. When "CS" appears under the data, the test was performed using the **Rightest™** Control Solution GC550. The control solution test result will not be used when recalling test average results.

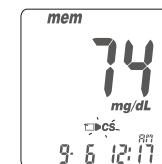
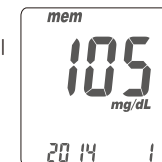

Recalling Test Results

The GE006 Blood Glucose meter provides several average test results. View the 1-day, 7-days, 14-days, 30-days, 60-days and 90-days average test results for better blood glucose monitoring.

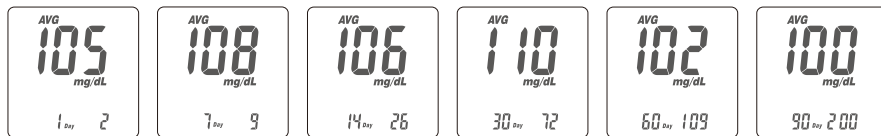

1. Press the Main button to switch the screen to Average Mode.
2. On the average screen, use either the Left or Right button to view 1-day, 7-days, 14-days, 30-days, 60-days or 90-days averages.
3. The number shown in the lower right hand corner indicates how many test results have been calculated.
4. Excluding test results from the average calculation:
You may exclude the test result from average calculation right after each test.
You have to perform this exclusion immediately after the meter displays the reading of your test result. Press the Right or Left button to choose "NO AVG" then press the main button to confirm. The test result is now excluded from averaging.

Recalling Average Test Results

5. Quick Searching:

To view test results in sequential order automatically, enter the Memory Mode. Press the Right or Left button for 2 seconds. (The Right button is for viewing from the most current to the oldest test results. The Left button is for viewing from the oldest to the most current test results). Release the button to stop at any particular test result.



NOTE

- The Average function requires that the correct time and date is set. Test results must exist during the desired time interval. For example: To get a 14-day average on 1/30/14, you must have test results dated between 1/17 and 1/30. If no test results exist during that time frame you will not receive an average.
- To exclude test results from average calculation, you need to remain in Test Mode and perform the exclusion right after you get the test result. Once you move to MEM Mode, Average Mode or Time Mode, you will not be able to perform the exclusion.
- The "Lo", "Hi" results, control solution test results and test results under abnormal temperature < 50°F (10°C), > 104°F (40°C) will be excluded from average calculations.

Caring for Your Meter

Maintenance

Keep your meter and test strip free of dust, water or any other liquid. Store the meter in the carrying case when not in use. If your meter is dropped or damaged, perform a quality control test with the control solution before performing a blood glucose test.

Cleaning Meter

Clean the outside of the meter with a damp cloth and mild soap/detergent. Do not get the test strip port wet.

Cleaning Test Strip Port

If your test strip port is stained with blood, control solution or any liquid, please use a dry tissue or alcohol swab to clean it immediately. Do not use anything wet to clean it. Perform a quality control test to ensure the GE006 Blood Glucose Meter is working properly.

Cleaning and Disinfecting Procedures

Indirect transmission of Human Immunodeficiency Virus (HIV), Hepatitis B Virus (HBV) and Hepatitis C Virus (HCV) during the delivery of healthcare services has been increasingly reported. Persons using blood glucose monitoring systems have been identified as one risk group due to the shared use of fingerstick (lancing) devices and point of care blood testing devices.

The cleaning procedure is to remove dust, blood and body fluid from the surface and should be performed whenever the meter or lancing device is visibly dirty. Performing the cleaning procedure once per week is recommended. The disinfecting procedure is necessary to kill pathogens such as HIV, HBV and HCV on the device. This procedure should be performed periodically; once per week is recommended. The meter and lancing device should be cleaned before being disinfected.

If the meter is being operated by a second person who is providing testing assistance to the user, the meter and lancing device should be decontaminated prior to use by the second person. NOTE: the cleaning procedure can only remove visible contaminants from surfaces. Only the disinfecting procedure can eliminate non-visible pathogens.

DisCide® ULTRA DISINFECTING TOWELETTES may be used to clean and disinfect the meter and lancing device. Users may purchase the disinfecting wipes from the manufacturer (Palmero Health Care), distributors or major on line retail sites such as amazon.com. You can contact Palmero Health Care customer service at 1-800-344-6424 and customerservice@Palmerohealth.com.

Cleaning and Disinfecting Procedures



NOTE

- Clean and disinfect the outside of the device only. Do not remove battery cover when cleaning and disinfecting.

To clean the meter:

1. Thoroughly wipe the entire surface of the meter with disinfecting wipes listed above to clean any possible dirt, dust, blood and other body fluids.

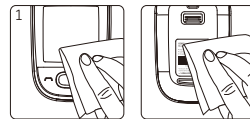

To disinfect the meter:

2. Take another disinfecting wipe and wipe the meter thoroughly. (Note: All blood and body fluids should be cleaned from surface before performing the disinfecting procedure)
3. Allow the surface to remain wet for 1 minute.
4. Allow to air dry.



NOTE

- Your GE006 Blood Glucose Meter has been tested to ensure that there is no change in the performance or external materials of the device after 550 cleaning cycles and 550 disinfecting cycles. The testing simulates 2 cleaning and disinfecting cycles per week over the typical life of the meter (5 years).

Cleaning and Disinfecting Procedures

To clean the lancing device:

1. Thoroughly wipe the entire surface of the lancing device with disinfecting wipes listed above to clean any possible dirt, dust, blood and other body fluids.

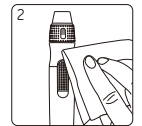
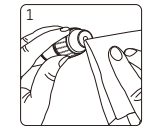

To disinfect the lancing device:

2. Take another disinfecting wipe and wipe the Lancing device thoroughly. (Note: All blood and body fluids should be cleaned from surface before performing disinfecting procedure)
3. Allow the surface to remain wet for 1 minute.



NOTE

- Your **Rightest™** GD500 Lancing Device has been tested to ensure that there is no change in the performance of the device after 550 cleaning cycles and 550 disinfecting cycles. The testing simulates 2 cleaning and disinfecting cycles per week over the typical life of the meter (5 years).

Cleaning and Disinfecting Procedures

CAUTION

- Users should wash their hands thoroughly with soap and water after handling the meter, lancing device or test strips.
- Please examine your LCD screen, test strip port, buttons and surface of your meter and lancing device after cleaning and disinfecting cycles. Stop using the meter and/or lancing device if any of the following occur:
 - Thin, silver streaks appear on the screen,
 - The screen becomes cracked, soft, dissolved, brittle or swollen.
 - You are unable to turn on/off your meter, operate the left/ right button, the lancing device release button or depth adjustable cap.
 - You are unable to enter meter settings, function modes or recall your testing results.

If you have any questions or concerns, please contact your GE006 Blood Glucose Monitoring System authorized representative or call the Customer Service at 886 0800 241 688.

Error Messages and Troubleshooting

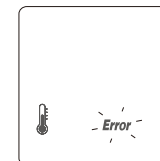

Temperature Error

1. In order to get accurate testing results, please test between 50-104 °F (10-40 °C).
2. When the temperature is below 43 °F (6 °C) or over 111 °F (44 °C), the meter will not function and the " **Error** " symbol will blink.
3. If the GE006 Blood Glucose Meter and Test Strips are exposed to a substantial change in temperature, please wait 45 minutes before measurement.





Error Messages and Troubleshooting

Battery Error

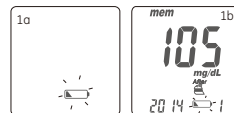
1. The "  " symbol blinks when the battery power is low. Please change the battery as soon as possible. You can still test.
2. The "  " and " **Error** " symbols blink when the battery is too low. Meter cannot test. Please change the battery immediately.



Strip Error

1. When the test strip is inserted incorrectly, the meter will beep 4 times while the "  " symbol flashes. Do not apply a sample on the test strip. Please re-insert the unused test strip correctly (refer to "Handling the GE006 Blood Glucose Test Strip" on Page 24 for more information).
2. If, after performing the required steps, the "  " and flashing " **Error** " symbols appear on the screen, it means the GE006 Test strip has been inserted incorrectly more than twice. Please, re-insert the unused test strip again after reviewing the steps on how to insert a test strip correctly on p. 24 or call Customer Service for support. This error message can also indicate that you may have used the wrong test strips. Please check the test strip vial to ensure you are using the GE006 Test strips.

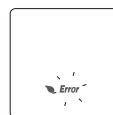
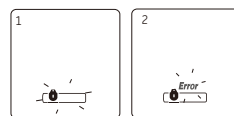
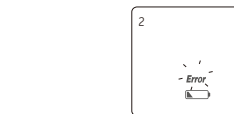

Sampling Error

Please do not apply the blood to the sample port of the test strip before the meter displays "  ". Discard the test strip if the meter shows " **Error** ".

Error Messages and Troubleshooting

- Er1** - The inserted test strip has been used or damaged. Please use a new test strip.
- Er2** - The meter has malfunctioned. Do a Quality Control Test or reinstall the batteries to check if the meter works properly.
- Er3** - The signal transmission is disrupted. Repeat the test using a new test strip.
- Er4** - The blood sample volume is insufficient. Repeat the test using a new test strip.
- Er5** - An issue calibrating the Meter has occurred. Please follow the steps below:
- (1) Remove the test strip from the meter.
 - (2) Turn off the meter (press and hold the Main button for 3 seconds).
 - (3) Press the main button to turn ON the meter.
- If after turning on the Meter, you do not see Er5, your meter is functioning properly and able to perform a test.
- If one of the above error messages still appears, please contact Customer Service at 886-0800-241-688.

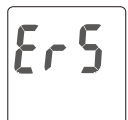
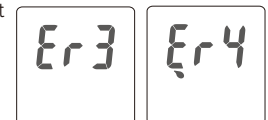
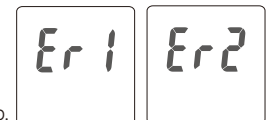

Meter Malfunction

If the GE006 Blood Glucose Meter will not turn on, please follow the steps below:

1. Open the battery cover and remove the batteries.
 2. Wait for 5 minutes and reinsert the batteries as described as instructed on page 16, (Meter Activation and Changing the Battery).
- The meter should work normally after finishing the above steps. If the meter still does not work, please contact Customer Service at 886-0800-241-688.

Error Messages and Troubleshooting

Limitations



CAUTION

A blood sample should ONLY be applied to the test strip after the test strip has been inserted correctly and the Meter's screen is showing the image of the test strip and a blood drop flashing symbol. If the blood drop flashing symbol is NOT showing on the screen, do not apply a sample to the test strip. Please re-insert the unused test strip correctly. The screen MUST show the image of the test strip accompanied by the blood drop symbol flashing (this symbol takes 3 seconds to show after correctly inserting the test strip) in order for a sample to be applied. Please consult your User Manual and/or contact Customer Service for support on how to correctly insert a GE006 Test strip.

- GE006 Blood Glucose Monitoring System is not intended for serum or plasma testing.
- Inaccurate test results may be obtained at altitudes greater than 10,000 feet (3048 meters) above sea level.
- Severe dehydration and excessive water loss may cause inaccurately low results.
- High concentrations of Uric acid ≥ 10.0 mg/dL, L-Dopa ≥ 3 mg/dL, Dopamine ≥ 2 mg/dL, Ascorbic acid (Vitamin C) ≥ 5 mg/dL may result in inaccurate test results.
- Not for neonatal use.
- For over-the-counter use. For single-patient use only. For in vitro diagnostic use only.
- Not for screening or diagnosis of diabetes mellitus.
- Not for use on critically ill patients in shock, dehydrated patients or hypo-osmolar patients.
- Alternative site testing (AST) should only be performed during steady-state times (when glucose is not changing rapidly).
- Alternative Site Testing should not be used to calibrate continuous glucose monitoring systems (CGMS).
- Alternative site testing should not be performed if testing for hypoglycemia (Low blood glucose).
- Results from alternative site testing should not be used in insulin dose calculation.

Real Time Synchronize

The GE006 Blood Glucose Meter can be used with the HeartSquare App, a mobile application. After pairing the GE006 Blood Glucose Meter with the mobile phone by Bluetooth, the HeartSquare App will automatically detect any activities on the GE006 Blood Glucose Meter. Upon detection or activation of the GE006 Blood Glucose Meter, the HeartSquare App will display the current status of the GE006 Blood Glucose Meter, as well as a step by step walk through of performing a new blood glucose test.

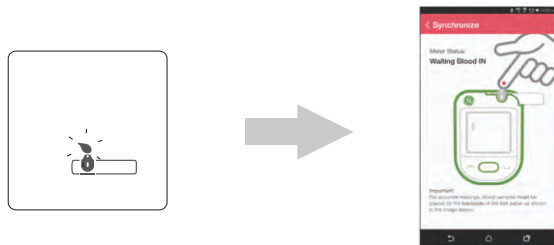

A blood drop icon will appear on the display window of Meter. And the indication of applying blood will also appear on the screen of your mobile phone.

Real Time Synchronize

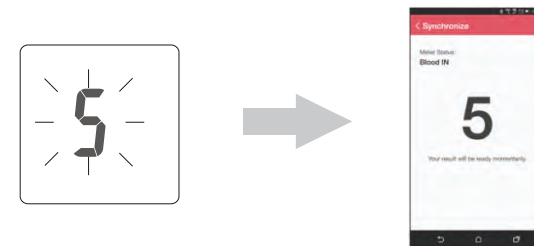

Countdown Mode will begin both on the display window of the meter and the screen of your mobile phone.



NOTE

- For more information of HeartSquare App, please visit www.heartsquare.com.
- The screenshots in this User's Manual were taken from a mobile phone using Android 4.3+. Appearance may vary slightly depending on the operating system and manufacturer of your mobile phone.

FEDERAL COMMUNICATIONS COMMISSION (FCC) STATEMENT

15.21

You are cautioned that changes or modifications not expressly approved by the part responsible for compliance could void the user's authority to operate the equipment.

15.105(b)

This equipment has been tested and found to comply with the limits for a Class B digital device, pursuant to part 15 of the FCC rules. These limits are designed to provide reasonable protection against harmful interference in a residential installation. This equipment generates, uses and can radiate radio frequency energy and, if not installed and used in accordance with the instructions, may cause harmful interference to radio communications. However, there is no guarantee that interference will not occur in a particular installation. If this equipment does cause harmful interference to radio or television reception, which can be determined by turning the equipment off and on, the user is encouraged to try to correct the interference by one or more of the following measures:

- Reorient or relocate the receiving antenna.
- Increase the separation between the equipment and receiver.
- Connect the equipment into an outlet on a circuit different from that to which the receiver is connected.
- Consult the dealer or an experienced radio/ TV technician for help.

FEDERAL COMMUNICATIONS COMMISSION (FCC) STATEMENT

This device complies with Part 15 of the FCC Rules. Operation is subject to the following two conditions:

- 1) this device may not cause harmful interference and
- 2) this device must accept any interference received, including interference that may cause undesired operation of the device.

NCC警語

A) 根據NCC低功率電波輻射性電機管理辦法第十條規定：

第十二條	經型式認證合格之低功率射頻電機，非經許可，公司、商號或使用者均不得擅自變更頻率、加大功率或變更原設計之特性及功能。
第十四條	低功率射頻電機之使用不得影響飛航安全及干擾合法通信；經發現有干擾現象時，應立即停用，並改善至無干擾時方得繼續使用。前項合法通信，指依電信法規定作業之無線電通信。低功率射頻電機須忍受合法通信或工業、科學及醫療用電波輻射性電機設備之干擾。

Specification

Measurement Technology	Oxidase Electrochemical Sensor
Sample	Capillary whole blood
Minimum Sample Volume	0.75 microliters
Measuring Range	10-600 mg/dL
Test Time	5 seconds
Memory Capacity	500 blood glucose test results with date and time
Power Saving	Turns off automatically 2 minutes after last user action. To turn off manually, press the main button "  " for 3 seconds.
Operating Temperature	50 ~ 104°F (10 ~ 40°C)
Operating Relative Humidity	10 - 90%

Specification

Hematocrit	30 - 60%
Power Supply	Two AAA Batteries
Battery Life	Approximately 800 tests, each test with one data transfer
Meter Dimension	85mm x 57mm x 22.5 mm
Meter Weight	81.0 ± 5g with batteries
Monitor	LCD
Display Area	39 mm x 39.5 mm
Meter Storage/ Transportation Conditions	14 ~ 140°F (-10 ~ 60°C)
Test Strip Storage/ Transportation Conditions	39 ~ 86°F (4 ~ 30°C), < 90% relative humidity

Warranty

Bionime Corporation warrants that this product will be free from defects in materials and workmanship for five years from the date of purchase.

This warranty does not apply to the performance of a GE006 Blood Glucose Meter that has been altered, misused, tampered with or abused in any way.

This warranty applies only to the original purchaser of the GE006 Blood Glucose Monitoring System.

Please complete and return the enclosed warranty card.

Different models have different specifications. This warranty applies only to the GE006 Blood Glucose Monitoring System; other models are not covered with this warranty card.

GE is a trademark of General Electric Company and is used under license by Bionime Corporation, No. 100, Sec. 2, Daqing St., South Dist., Taichung City 40242, Taiwan



NOTE

- During blood glucose measurement, the GE006 Blood Glucose Meter itself may come into contact with blood. All parts of the GE006 Blood Glucose Monitoring System are considered biohazardous and can potentially transmit infectious diseases. Please follow your health care professional's direction to properly dispose of the used GE006 Blood Glucose Monitoring System after removing the batteries.

Customer Service

Please review all of the instructions to make sure you are performing the steps correctly. If you have any questions or concerns, please contact your Bionime authorized representative. We will make every effort to provide assistance and solutions for you.

Description of used symbols

 IVD	For in vitro diagnostic use		Manufacturer
 LOT	Lot number		Expiry date
	Temperature limitation		For single use only
 STERILE R	Method of sterilization using irradiation		CE-mark (with No. of notified body)
 EC REP	EC Representative		Consult the instruction for use

Expected Glucose Values Without Diabetes

Expected glucose values without diabetes ⁽¹⁾

Status	Range (mg/dL)
Fasting	<100
Two Hours after meals	<140

References

1) American Diabetes Association: Standard of Medical Care in Diabetes 2014, Diabetes Care, Vol.37, supplement 1, S14-S80, January 2014.

Component Manufacturer Information

Log Book

Blood Glucose Meter, Test Strip, Control Solution

Manufacturer: Bionime Corporation

No. 100, Sec. 2, Daqing St., South Dist., Taichung City 40242, Taiwan

Product complies with In Vitro Diagnostic Medical Device Directive 98/79/EC. (CE0197)

EC-Rep: Bionime GmbH, Tramstrasse 16, 9442 Berneck / Switzerland

E-mail: info@bionime.ch

Lancing Device

Manufacturer: Bionime Corporation

No. 100, Sec. 2, Daqing St., South Dist., Taichung City 40242, Taiwan

Product complies with Medical Device Directive 93/42/EEC

EC-Rep: Bionime GmbH, Tramstrasse 16, 9442 Berneck / Switzerland

E-mail: info@bionime.ch

Disposable Sterile Lancets

Manufacturer: SteriLance Medical (SuZhou) Inc.

No.68 LiTangHe RD, XiangCheng, SuZhou, JiangSu 215133, P.R. China

Product complies with Medical Device Directive 93/42/EEC. (CE0197)

EC- Rep: EMERGO EUROPE, Molenstraat 15, 2513 BH The Hague, The Netherlands

Name:

Address:

Home Phone: Work Phone

Doctor: Doctor's Phone

Pharmacy: Pharmacy Phone

Insulin/Pills: Log book date From: To:

In case of emergency contact:

.....

.....

.....

Log Book

	DATE	M	T	W	T	F	S	S
Breakfast	Blood Glucose							
	Insulin/ Medication							
Lunch	Blood Glucose							
	Insulin/ Medication							
Dinner	Blood Glucose							
	Insulin/ Medication							
Bedtime	Blood Glucose							
	Insulin/ Medication							
Other	Blood Glucose							
	Insulin/ Medication							
Comments								

Log Book

	DATE	M	T	W	T	F	S	S
Breakfast	Blood Glucose							
	Insulin/ Medication							
Lunch	Blood Glucose							
	Insulin/ Medication							
Dinner	Blood Glucose							
	Insulin/ Medication							
Bedtime	Blood Glucose							
	Insulin/ Medication							
Other	Blood Glucose							
	Insulin/ Medication							
Comments								

Log Book

	DATE	M	T	W	T	F	S	S
Breakfast	Blood Glucose							
	Insulin/ Medication							
Lunch	Blood Glucose							
	Insulin/ Medication							
Dinner	Blood Glucose							
	Insulin/ Medication							
Bedtime	Blood Glucose							
	Insulin/ Medication							
Other	Blood Glucose							
	Insulin/ Medication							
Comments								

Log Book

	DATE	M	T	W	T	F	S	S
Breakfast	Blood Glucose							
	Insulin/ Medication							
Lunch	Blood Glucose							
	Insulin/ Medication							
Dinner	Blood Glucose							
	Insulin/ Medication							
Bedtime	Blood Glucose							
	Insulin/ Medication							
Other	Blood Glucose							
	Insulin/ Medication							
Comments								

Log Book

	DATE	M	T	W	T	F	S	S
Breakfast	Blood Glucose							
	Insulin/ Medication							
Lunch	Blood Glucose							
	Insulin/ Medication							
Dinner	Blood Glucose							
	Insulin/ Medication							
Bedtime	Blood Glucose							
	Insulin/ Medication							
Other	Blood Glucose							
	Insulin/ Medication							
Comments								

Log Book

	DATE	M	T	W	T	F	S	S
Breakfast	Blood Glucose							
	Insulin/ Medication							
Lunch	Blood Glucose							
	Insulin/ Medication							
Dinner	Blood Glucose							
	Insulin/ Medication							
Bedtime	Blood Glucose							
	Insulin/ Medication							
Other	Blood Glucose							
	Insulin/ Medication							
Comments								

Log Book

	DATE	M	T	W	T	F	S	S
Breakfast	Blood Glucose							
	Insulin/ Medication							
Lunch	Blood Glucose							
	Insulin/ Medication							
Dinner	Blood Glucose							
	Insulin/ Medication							
Bedtime	Blood Glucose							
	Insulin/ Medication							
Other	Blood Glucose							
	Insulin/ Medication							
Comments								

Log Book

	DATE	M	T	W	T	F	S	S
Breakfast	Blood Glucose							
	Insulin/ Medication							
Lunch	Blood Glucose							
	Insulin/ Medication							
Dinner	Blood Glucose							
	Insulin/ Medication							
Bedtime	Blood Glucose							
	Insulin/ Medication							
Other	Blood Glucose							
	Insulin/ Medication							
Comments								

Log Book

	DATE	M	T	W	T	F	S	S
Breakfast	Blood Glucose							
	Insulin/ Medication							
Lunch	Blood Glucose							
	Insulin/ Medication							
Dinner	Blood Glucose							
	Insulin/ Medication							
Bedtime	Blood Glucose							
	Insulin/ Medication							
Other	Blood Glucose							
	Insulin/ Medication							
Comments								

Log Book

	DATE	M	T	W	T	F	S	S
Breakfast	Blood Glucose							
	Insulin/ Medication							
Lunch	Blood Glucose							
	Insulin/ Medication							
Dinner	Blood Glucose							
	Insulin/ Medication							
Bedtime	Blood Glucose							
	Insulin/ Medication							
Other	Blood Glucose							
	Insulin/ Medication							
Comments								

Log Book

	DATE	M	T	W	T	F	S	S
Breakfast	Blood Glucose							
	Insulin/ Medication							
Lunch	Blood Glucose							
	Insulin/ Medication							
Dinner	Blood Glucose							
	Insulin/ Medication							
Bedtime	Blood Glucose							
	Insulin/ Medication							
Other	Blood Glucose							
	Insulin/ Medication							
Comments								

Log Book

	DATE	M	T	W	T	F	S	S
Breakfast	Blood Glucose							
	Insulin/ Medication							
Lunch	Blood Glucose							
	Insulin/ Medication							
Dinner	Blood Glucose							
	Insulin/ Medication							
Bedtime	Blood Glucose							
	Insulin/ Medication							
Other	Blood Glucose							
	Insulin/ Medication							
Comments								

Log Book

	DATE	M	T	W	T	F	S	S
Breakfast	Blood Glucose							
	Insulin/ Medication							
Lunch	Blood Glucose							
	Insulin/ Medication							
Dinner	Blood Glucose							
	Insulin/ Medication							
Bedtime	Blood Glucose							
	Insulin/ Medication							
Other	Blood Glucose							
	Insulin/ Medication							
Comments								

Log Book

	DATE	M	T	W	T	F	S	S
Breakfast	Blood Glucose							
	Insulin/ Medication							
Lunch	Blood Glucose							
	Insulin/ Medication							
Dinner	Blood Glucose							
	Insulin/ Medication							
Bedtime	Blood Glucose							
	Insulin/ Medication							
Other	Blood Glucose							
	Insulin/ Medication							
Comments								

Warranty Card

Name	Tel	Distributor name and address
Address		
Serial No	Model	
Date of purchase		

(Please present this card for replacement purpose)

Limited warranty:

1. Bionime warrants to the original purchaser only, that the GE006 Blood Glucose Meter shall be free of any defects in materials or workmanship and, provided it is not modified, altered or misused, will perform in accordance with specifications for a period of five (5) years from the original date of purchase.
2. Bionime guarantees the performance of the GE006 Blood Glucose Meter only if used as directed and provided that the failure to perform has not been caused in whole or in part by the use of test strips that are not GE006 Blood Glucose Test Strips manufactured by Bionime. Use only GE006 Blood Glucose Test Strips in your GE006 Blood Glucose Meter.
3. The sole obligation of Bionime under this warranty shall be to replace any defective GE006 Blood Glucose Meter. No other warranties, express or implied, are made. Bionime shall not be responsible for any incidental or consequential damages.
4. You must contact your distributor for assistance and/or instructions for obtaining a replacement GE006 Blood Glucose Meter.



Warranty Card

Distributor name and address

PLACE
STAMP
HERE

Warranty Card

Thank you for purchasing our product. Please complete and mail this warranty card within 30 days of purchase of your GE006 Blood Glucose Monitoring System.

Name	Male/Female	Date of Birth
Address		
City	Country	Postal Code
Phone Number		
Healthcare Professional Who Recommended	City	Country
Store/Pharmacy Name Where Purchased	City	Country
Date of Purchase	Model No.	Serial/Lot No.

Do you have Type I Type II Gestational Diabetes ?
Have you owned a blood glucose monitoring system before ? Yes No
Which brand/s were you most recently using ? _____
Will the GE006 Blood Glucose Monitoring System be your primary system ? Yes No
How often do you test your blood glucose ? Times per day _____ per week _____
Do you use insulin ? Yes No Oral medication ? Yes No
How did you hear about the GE006 Blood Glucose Monitoring System ? _____

Thank you for answering these questions and for your purchase of the GE006 Blood Glucose Monitoring System.



Emergency Card

EMERGENCY CARD GE006 Blood Glucose Monitoring System



- User Name:
- User Phone No.:
- Blood Type:
- Doctor/Hospital:

I am a diabetes patient. If you find me in a coma or stupor, please take me to the hospital on left side. Or call :

* Please fill this card and carry with you at anytime.

