



BIOSCRYPT  
ENTERPRISE ACCESS SOLUTIONS

# 4G INSTALLATION GUIDE

Version 4.4.2.0.0.0.0



## Copyright Information

© 2011, L-1 Identity Solutions, Inc.

All rights reserved. This product and related documentation are protected by copyright and distributed under licenses restricting their use, copying, distribution, and de-compilation. No part of this product or related documentation may be reproduced in any form by any means without written permission from L-1 Identity Solutions and its licensors, if any.

Redistributions of source code must retain the above copyright notice, this list of conditions and the following disclaimer. Redistributions in binary form must reproduce the above copyright notice, this list of conditions and the following disclaimer in the documentation and/or other materials provided with the distribution.

Neither the name of the L-1 Identity Solutions, Inc. nor the names of its contributors may be used to endorse or promote products derived from this software without specific prior written permission.

## TRADEMARKS

The trademarks identified herein are the trademarks or registered trademarks of L-1 Identity Solutions, Inc. All other brands and products referenced herein are acknowledged to be trademarks or registered trademarks of their respective holders or manufacturers.

THE PRODUCT AND PUBLICATION ARE PROVIDED “AS IS” WITHOUT WARRANTY OF ANY KIND, EITHER EXPRESS OR IMPLIED, INCLUDING, BUT NOT LIMITED TO, THE IMPLIED WARRANTIES OF MERCHANTABILITY, FITNESS FOR A PARTICULAR PURPOSE, OR NON-INFRINGEMENT.

THIS PUBLICATION COULD INCLUDE TECHNICAL INACCURACIES OR TYPOGRAPHICAL ERRORS. CHANGES ARE PERIODICALLY ADDED TO THE INFORMATION HEREIN; THESE CHANGES WILL BE INCORPORATED IN NEW EDITIONS OF THE PUBLICATION. L-1 IDENTITY SOLUTIONS, INC MAY MAKE IMPROVEMENTS AND/OR CHANGES IN THE PRODUCT(S) AND/OR THE PROGRAM(S) DESCRIBED IN THIS PUBLICATION AT ANY TIME.

**IMPORTANT**—Please refer to the L-1 Identity Solutions End User License Agreement document and read it carefully before using any L-1 Identity Solutions software on your computer. This document contains important information about your legal rights.

## Table of Contents

<b>CHAPTER 1 - INTRODUCTION</b> .....	<b>7</b>
CHAPTER OVERVIEW.....	7
1.1 SYMBOLS USED IN THIS GUIDE.....	7
1.2 PRODUCT OVERVIEW.....	9
1.2.1 4G V-FLEX LITE & CR-PASS.....	9
1.2.2 4G SECURE CONTROL.....	10
1.3 DEVICE DIMENSIONS.....	11
1.3.1 4G V-FLEX LITE.....	11
1.3.2 4G CR-PASS.....	12
1.3.3 4G SECURE CONTROL.....	13
1.4 SAFETY PRECAUTIONS.....	14
1.4.1 ELECTROSTATIC DISCHARGE.....	14
1.4.2 DEVICE HANDLING GUIDELINES.....	15
<b>CHAPTER 2 - PLANNING THE INSTALLATION</b> .....	<b>16</b>
CHAPTER OVERVIEW.....	16
2.1 PLANNING THE INSTALLATION.....	16
2.1.1 RECOMENDED STEPS FOR A SUCCESSFUL INSTALLATION.....	17
2.1.2 REQUIREMENTS.....	18
2.1.2.1 HARDWARE REQUIREMENTS.....	18
2.1.2.2 COMPUTER REQUIREMENTS.....	18
2.1.2.2.1 SECUREADMIN LITE SERVER REQUIREMENTS.....	18
2.1.2.2.2 SECUREADMIN LITE CLIENT REQUIREMENTS.....	19
2.1.2.2.3 MICROSOFT .NET FRAMEWORK 3.5 SP1 REQUIREMENTS.....	19
2.1.2.2.4 SUPPORTED OPERATING SYSTEMS.....	19
2.1.2.2.5 SQL SERVER 2008 EXPRESS EDITION.....	19
2.1.2.3 NETWORK REQUIREMENTS.....	19
2.1.2.4 SOFTWARE REQUIREMENTS.....	19
2.1.3 UNPACK EQUIPMENT.....	20
2.1.3.1 PARTS LIST.....	20
2.1.3.1.1 4G V-FLEX LITE, 4G CR-PASS.....	20
2.1.3.1.2 4G SECURECONTROL.....	21
2.1.3.1.3 DOCUMENTATION.....	21
2.1.4 CHOOSING THE INSTALL LOCATION.....	22
2.1.4.1 4G V-Flex Lite and CR-Pass.....	22
2.1.4.2 4G SecureControl.....	22
2.1.5 PLAN DEVICE NETWORK.....	22
2.1.6 CHOOSE NETWORK TYPE.....	23
2.1.6.1 RS-485.....	24
2.1.6.1.1 RS-485 CABLE SPECIFICATION.....	24
2.1.6.1.2 RS-485 CABLE LENGTHS.....	25
2.1.6.1.3 RS-485 NETWORK TOPOLOGY.....	25
2.1.6.2 ETHERNET.....	25
2.1.7 CHOOSE POWER SOURCE.....	26

<b>CHAPTER 3 - INSTALL SOFTWARE</b> .....	<b>27</b>
CHAPTER OVERVIEW.....	28
3.1 SECUREADMIN LITE SERVER.....	29
3.1.1 REPAIRING AN INSTALLATION OF SECUREADMIN LITE SERVER.....	34
3.1.2 UNINSTALLING SECUREADMIN LITE SERVER.....	35
3.1.3 UPGRADING AN INSTALLATION OF SECUREADMIN LITE SERVER.....	36
3.2 SECUREADMIN LITE CLIENT.....	36
3.2.1 MODIFYING AN INSTALLATION OF SECUREADMIN LITE CLIENT.....	42
3.2.2 REPAIRING AN INSTALLATION OF SECUREADMIN LITE CLIENT.....	43
3.2.3 UNINSTALLING SECUREADMIN LITE CLIENT.....	43
3.2.4 UPGRADING AN INSTALLATION OF SECUREADMIN LITE CLIENT.....	44
<b>CHAPTER 4 - INSTALL HARDWARE</b> .....	<b>44</b>
CHAPTER OVERVIEW.....	44
4.1 WALL-MOUNTING SCHEMES.....	45
4.2 INSTALLING A MOUNTING PLATE.....	45
4.2.1 4G V-FLEX LITE AND 4G CR-PASS.....	45
4.3 INSTALLATION HARDWARE.....	47
4.3.1 4G V-FLEX LITE AND 4G CR-PASS Quantity.....	48
4.4 ATTACH DEVICE TO MOUNTING PLATE.....	48
4.4.1 4G V-FLEX LITE AND 4G CR-PASS.....	48
4.5 CONNECT DEVICE TO POWER SOURCE.....	49
4.6 CONNECT DEVICE TO NETWORK.....	51
4.6.1 ETHERNET NETWORK CONNECTIONS.....	52
4.6.2 RS-485 NETWORK CONNECTIONS.....	52
4.7 SINGLE-DOOR CONTROLLER INSTALLATION.....	52
4.8 AUX PORT.....	55
4.9 INSTALL FERRITE CORE.....	57
<b>CHAPTER 5 - SYSTEM START-UP PROCEDURES</b> .....	<b>57</b>
CHAPTER OVERVIEW.....	57
5.1 SYSTEM START-UP PROCEDURES.....	59
5.1.1 DEVICE CONFIGURATION CHECK.....	59
5.1.2 RS-232 TO RS-485 CONVERTER GROUND FAULT CHECK.....	59
5.1.3 DEVICE GROUND FAULT CHECK.....	60
<b>CHAPTER 6 - CONFIGURE DEVICE</b> .....	<b>60</b>
OVERVIEW.....	60
6.1 REGISTER DEVICE.....	61
6.1.1 TO REGISTER A NETWORKED DEVICE.....	61
6.1.2 TO REGISTER A DEVICE VIA A CLIENT.....	64
<b>CHAPTER 7 - MAINTENANCE AND CLEANING</b> .....	<b>68</b>
CHAPTER OVERVIEW.....	69
7.1 CLEANING FINGER PRINT DEVICES.....	70
<b>CHAPTER 8 - TROUBLESHOOTING</b> .....	<b>72</b>
CHAPTER OVERVIEW.....	72

8.1	INSTALLATION ERROR MESSAGES.....	72
8.1.1	ERROR 1406 - INSUFFICIENT PRIVILEGES.....	72
8.1.2	ERROR 27552 - ERROR CREATING DATABASE.....	72
8.1.3	INVALID PASSWORD.....	73
8.1.4	ERROR 27502 - USER NOT ASSOCIATED WITH TRUSTED SQL SERVER.....	74
8.1.5	ERROR 27502 - SQL SERVER DOES NOT EXIST.....	75
8.1.6	INSUFFICIENT SYSTEM MEMORY.....	76
8.1.7	OUT OF DISK SPACE.....	77
<b>CHAPTER 9</b>	<b>- NOTICES.....</b>	<b>79</b>
	CHAPTER OVERVIEW.....	79
9.1	FCC and IC Information to Users .....	79
9.2	CE Information to Users.....	81
9.3	Warning to Users.....	81
<b>GLOSSARY.....</b>		<b>82</b>

## List of Figures

Figure 1-1	4G V-Flex Lite & CR-Pass.....	9
Figure 1-2	4G Secure Control.....	10
Figure 1-3	4G V-Flex Lite.....	11
Figure 1-4	4G CR-Pass.....	12
Figure 1-5	4G Secure Control.....	13
Figure 2-1	Correct Mounting Height.....	22
Figure 2-2	Example RS-485 System Diagram.....	23
Figure 2-3	Network Topologies Star and Daisy Chain Configurations.....	25
Figure 3-1	Install Menu.....	29
Figure 3-2	SecureAdmin Lite Server Installation Wizard.....	29
Figure 3-3	SecureAdmin Lite Server License Agreement.....	30
Figure 3-4	SecureAdmin Lite Server Choose Destination Location.....	31
Figure 3-5	Database Selection.....	32
Figure 3-6	Connecting to SQL Server option.....	33
Figure 3-7	Upgrade Confirmation.....	36
Figure 3-8	SecureAdmin Lite Server Installation Complete.....	36
Figure 3-9	Menu.....	37
Figure 3-10	InstallShield Wizard.....	37
Figure 3-11	Welcome Screen.....	38
Figure 3-12	SecureAdmin Lite Client License Agreement.....	38
Figure 3-13	SecureAdmin Lite Client Choose Destination Location.....	39
Figure 3-14	Fingerprint Placement Feedback Option Selection.....	40
Figure 3-15	InstallShield Wizard Finished.....	41
Figure 4-1	4G V-Flex Lite Flush-mount Mounting Plate (in mm).....	45
Figure 4-2	4G CR-Pass Flush-mount Mounting Plate (in mm).....	45
Figure 4-3	4G SecureControl Mounting Hole Locations (in mm).....	46
Figure 4-4	Connections for an External Wall Adapter (4G V-Flex Lite).....	49
Figure 4-5	Connections for an External Power Source (4G V-Flex Lite).....	49
Figure 4-6	Certification Marks.....	49

Figure 4-7 Power Over Ethernet Connection.....	50
Figure 4-8 RJ45 Pin Location.....	51
Figure 4-9 4G V-Flex Lite and 4G CR-Pass - Pin-out Diagram.....	52
Figure 4-10 Connections for Internal Relay Operation.....	53
Figure 4-11 Connections for External Relay Operation.....	54
Figure 4-12 Location of Aux Port At the Bottom of the 4G V-Flex Lite.....	55
Figure 4-13 USB Memory Key.....	56
Figure 6-1 Network Sidebar Tab.....	61
Figure 6-2 Register via Server Dialog Box.....	61
Figure 6-3 Server Communication Parameter.....	62
Figure 6-4 Register Device Dialog Box.....	63
Figure 6-5 Device Summary Dialog Box.....	64
Figure 6-6 Step 1 Find Device Dialog Box.....	65
Figure 6-7 Step 2 Device Information Dialog Box.....	66
Figure 6-8 Step 3 Server Communication Parameter Dialog Box.....	66
Figure 6-9 Step 4 Register Device Dialog Box.....	67
Figure 6-10 Device Summary Dialog Box.....	68
Figure 8-1 Error 1406.....	72
Figure 8-2 Error 27552.....	72
Figure 8-3 Invalid Password.....	73
Figure 8-4 Error 27502 - User Not Associated.....	74
Figure 8-5 Error 27502 - Server Does Not Exist.....	75
Figure 8-6 Insufficient System Memory.....	76
Figure 8-7 Out of Disk Space.....	77

## List of Tables

Table 2-1 Communications Network Comparison.....	24
Table 2-2 Category 5 Cable Characteristics.....	24
Table 2-3 4G V-Flex Lite, CR-Pass, and SecureControl Power Requirements.....	26
Table 4-1 PoE Pin Assignments.....	50

# CHAPTER 1 - INTRODUCTION


## CHAPTER OVERVIEW


This chapter provides an introduction to the L-1 Identity Solution 4G Lite product family devices. The 4G V-Flex Lite, 4G CR-Pass and 4G Secure Control, their specifications and features, and safety guidelines that should be observed when using or handling the devices.


This manual provides step-by-step procedures for installing all L-1 Identity Solutions 4G Lite devices. It covers the entire process of physically installing the device, making the necessary power, ground, and network connections, and registering the device with the SecureAdmin Lite administration software. Instructions for field repairs and cleaning are also provided.


## 1.1 SYMBOLS USED IN THIS GUIDE

The symbols shown below are used throughout this manual. They denote special issues the user might encounter. Their definitions are given below.

	<b>DANGER</b>
	This symbol denotes a danger condition that may cause death or excessive damage to property.

	<b>WARNING</b>
	This symbol denotes a warning condition that may cause severe injury or major damage to property.

	<b>CAUTION</b>
	This symbol denotes a cautionary condition that may cause injury or minor damage to property.

	<b>NOTICE</b>
	This symbol denotes a situation needing additional advice to avoid incorrect usage.



## 1.2 PRODUCT OVERVIEW

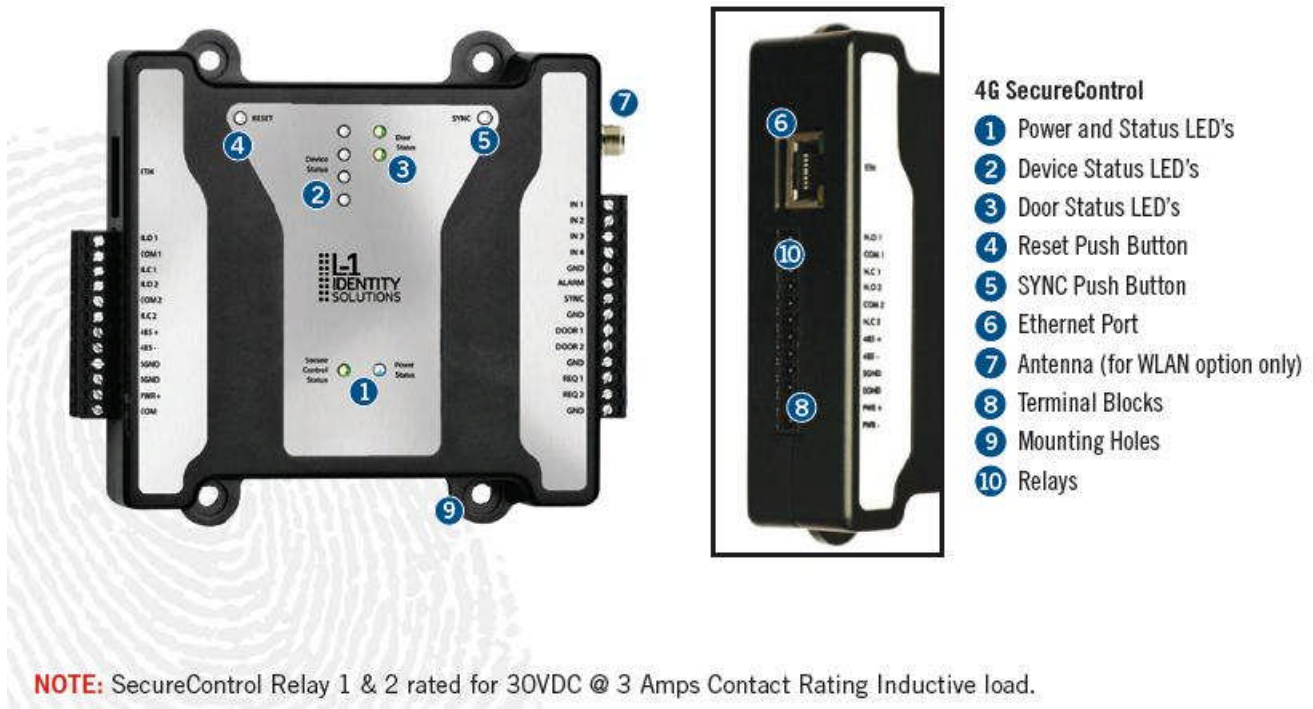
### 1.2.1 4G V-FLEX LITE & CR-PASS

Figure 1-1 4G V-Flex Lite & CR-Pass



## 1.2.2 4G SECURE CONTROL

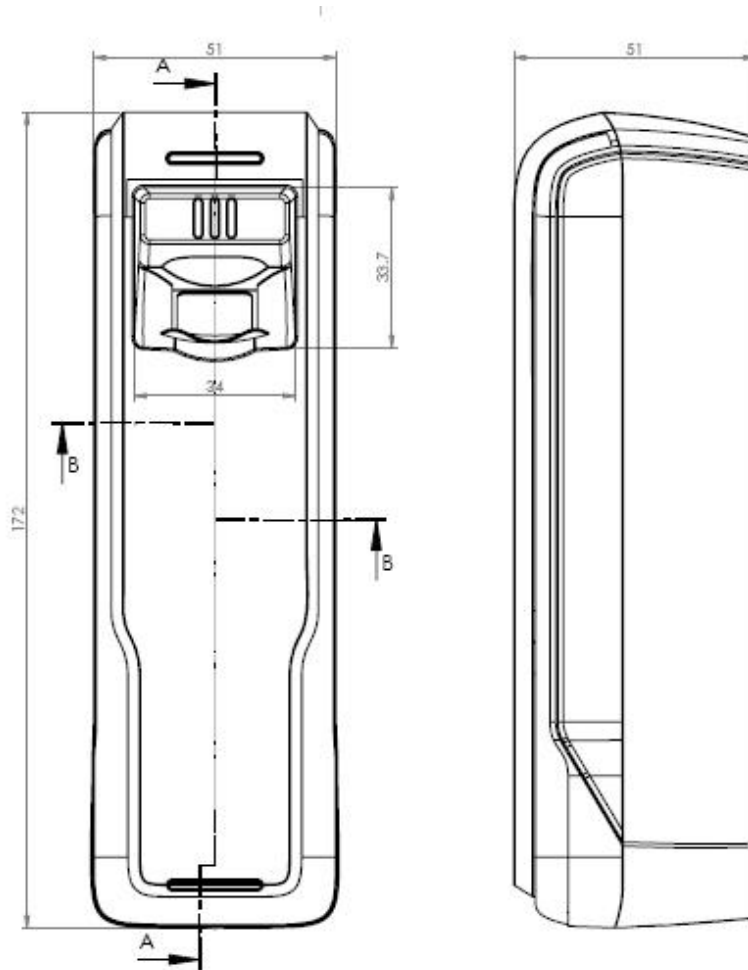
Figure 1-2 4G Secure Control



## 1.3 DEVICE DIMENSIONS

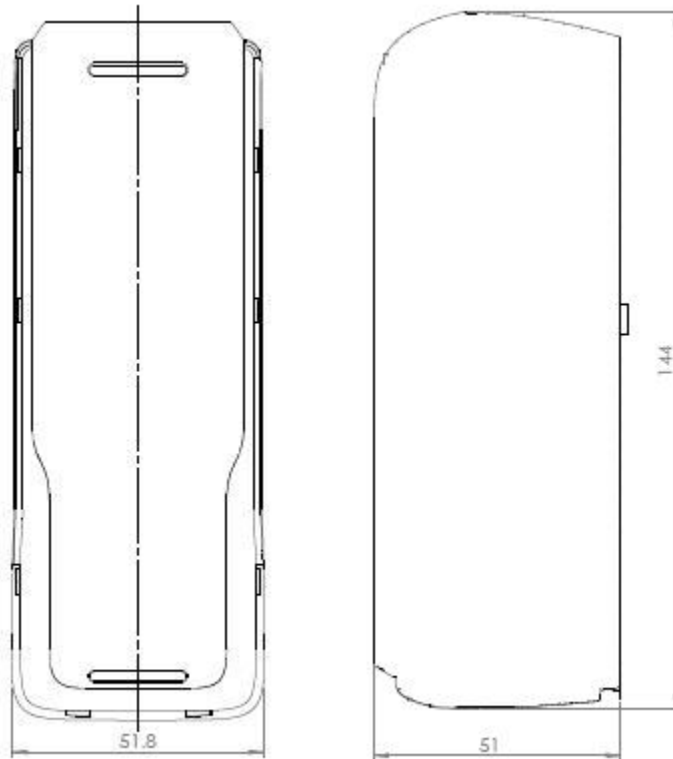
### 1.3.1 4G V-FLEX LITE

Figure 1-3 4G V-Flex Lite

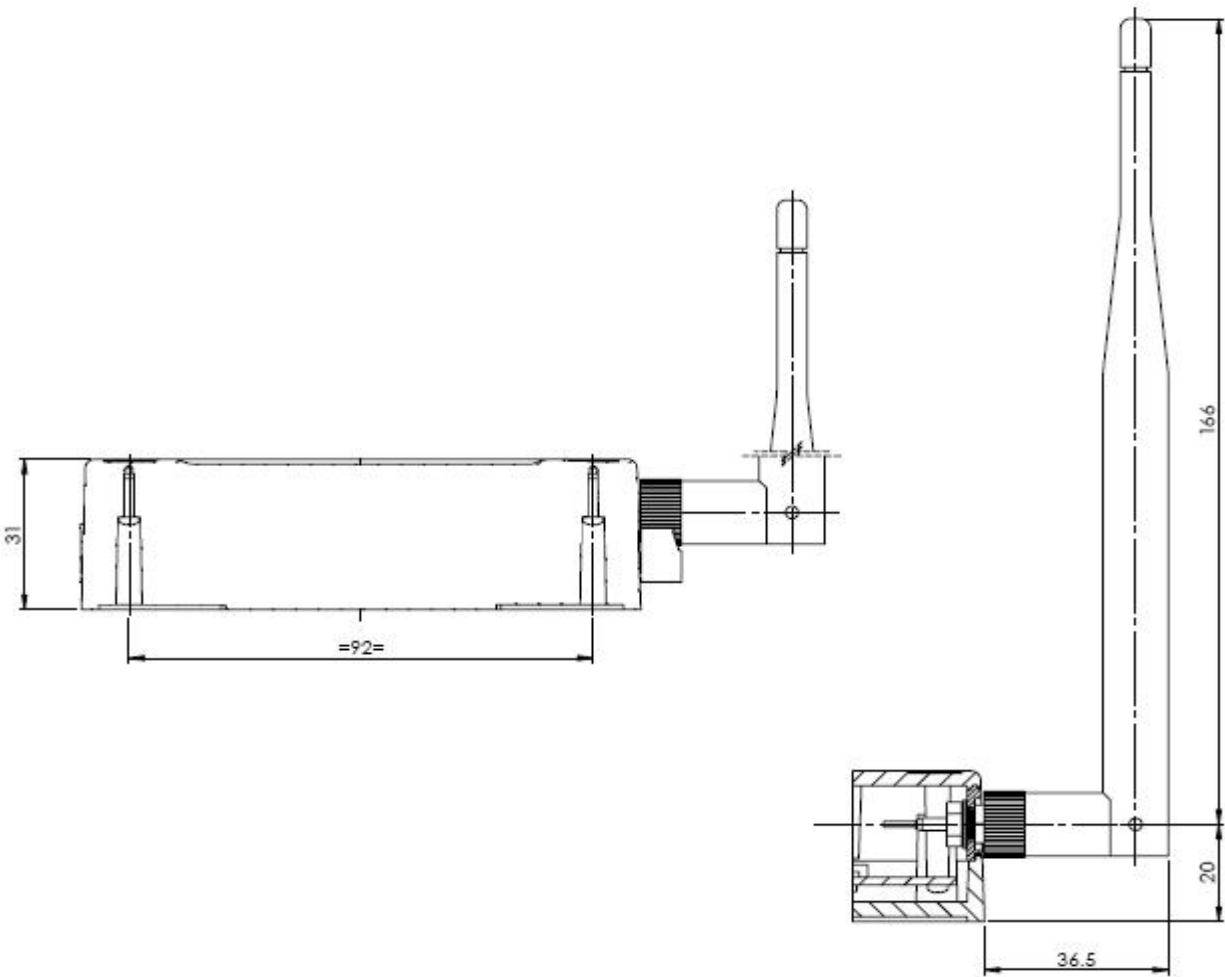


### 1.3.2 4G CR-PASS

Figure 1-4 4G CR-Pass







## 1.4 SAFETY PRECAUTIONS

Below are safety precautions that should be observed when operating or installing a device.

### 1.4.1 ELECTROSTATIC DISCHARGE

L-1 Identity Solutions recommends that Administrators inform Users of these points during the enrollment process:

- ✓ Always use the Ridge-Lock to position a finger \*before\* touching the sensor.
- ✓ Always stand on the ESD-dissipative floor covering (if installed).

- ✓ Do not touch other people or objects when touching the sensor.
- ✓ Always maintain at least 12 inches of space around yourself when touching the sensor.
- ✓ Do not allow articles of clothing to touch the sensor.

L-1 Identity Solutions recommends that Installers always follow these points (in addition to the points listed above):

- ✓ When installing or working on a unit, always use a grounding wrist-strap that is connected to a quality Earth ground.
- ✓ Check the device's cabling for ground faults.
- ✓ Ensure that the device's ground connection (located on the rear of the device) is connected to a quality Earth Ground.

#### **1.4.2 DEVICE HANDLING GUIDELINES**

- ✓ Do not install the device in locations where the device would be exposed to direct sunlight, high levels of relative humidity, particulate matter, or flammable vapors.
- ✓ Do not install the device near radiators or other heat sources.
- ✓ Do not allow magnetic objects to come within close proximity to the device.
- ✓ Strong magnetic fields might damage the device.
- ✓ Do not let liquids spill on the device.
- ✓ Do not attempt to alter the device for any reason. Modifications will void the product warranty.
- ✓ Do not attempt to disassemble the device in any way beyond what is necessary for sensor field replacement.
- ✓ Do not use the device for any purpose other than for what it was designed.
- ✓ Do not plug any equipment into the USB port other than flash memory devices.
- ✓ Do not allow users to place or hang objects on the device, such as coffee cups or purses.
- ✓ Do clean the device regularly to remove dust, grime, and fingerprint residue.

# CHAPTER 2 - PLANNING THE INSTALLATION

## CHAPTER OVERVIEW

This chapter details how to plan a successful installation, recommended steps, and explains the hardware and software components of typical setup scenarios.

## 2.1 PLANNING THE INSTALLATION

Planning the installation is the single most important aspect of a successful installation. In general, you need to consider the access controller, the door locks, the devices, and the need for a network. By the time you are ready to install the system, all of the details presented in the list below should be known. Take a moment to go through them now before starting your installation.

During the planning phase, you should determine:

- ✓ What type of authentication is required for your application?
- ✓ How many doors need to be secured?
- ✓ What type of device will be on each door? Doors already inside a secure area might not need the same type or level of security.
- ✓ If multiple 4G V-Series devices require networking for template distribution/management, then a dedicated PC is recommended to administer the system, as well as an RS-485 to RS-232 converter, and cabling for serial communications or cabling for Ethernet.
- ✓ Verify that the chosen access controller supports the Wiegand formats supported by 4G V-Series devices.
- ✓ Identify all wiring by the signal levels it is to carry. Use separate cables and conduits for different signal groups to avoid cross talk. Plan to separate them by these groups:

**Power distribution:** Wires carry power to devices, door strikes, etc.


**Data communication:** RS-485, USB, Wiegand, Ethernet, etc.

**Signal:** Door contact, request-to-exit push button, alarm input, etc.

- ✓ When planning device placement, determine the distance limitation of each signal type and use repeaters if necessary.



If you have any unresolved issues with the items on this list, contact L-1 Identity Solutions Technical Support for additional information before beginning any installation.

	<b>WARNING</b>
	4G Lite devices should be installed by only a qualified technician. If you are not qualified to perform an installation task, call L-1 Identity Solutions Technical Support or contact a qualified installer.

### 2.1.1 RECOMENDED STEPS FOR A SUCCESSFUL INSTALLATION

Every installation is unique. Sometimes the issues are well defined and can be handled in a standard fashion; sometimes the issues are very specific and may not be immediately recognizable.

L-1 Identity Solutions recommends following these steps for a successful installation:

- ✓ **Plan the installation** - Choose the type of hardware required, decide if a network is required, and decide on the location and number of required devices.
- ✓ **Unpack all items** - Unpack all items and check against the packing list.
- ✓ **Install network hardware components** - Install the cabling and components needed to run the system.
- ✓ **Install software** - Install the software needed to set up the devices.
- ✓ **Preconfigure device** - Connect the device to the USB cable, supply power to the device, and preconfigure the device.
- ✓ **Mount devices** - Mount the devices in their final locations
- ✓ **Power distribution and device hook up** - Connect the device wiring via the back panel.
- ✓ **Power-up procedure** - Check the power connections and start the system safely. Enroll users into the system (for user enrollment procedures).

Chapters 3 through 7 in this document present more information on these steps.

## 2.1.2 REQUIREMENTS

- ✓ PC workstation with:
- ✓ 1 GHz Intel(r) Pentium(r) 4 processor or equivalent
- ✓ 1 GB RAM (2 GB recommended)
- ✓ CD-ROM drive
- ✓ One available COM port or USB port
- ✓ Ethernet card
- ✓ Display: 1024 x 768 high color (minimum)
- ✓ Regulated DC Power supply
- ✓ Door controller
- ✓ TCP/IP network environment
- ✓ RS-232 to RS-485 converter with power supply (for advanced administrative features).

### 2.1.2.1 HARDWARE REQUIREMENTS

- ✓ Deadbolt/door strike
- ✓ Snubber diode required to protect regulated DC power supply from inductive kickback(1N4007 diode or equivalent recommended)
- ✓ Separate power supply for the deadbolt/door strike based on supplier's recommendations.
- ✓ External relay (if required)
- ✓ Networking cable

### 2.1.2.2 COMPUTER REQUIREMENTS

#### 2.1.2.2.1 SECUREADMIN LITE SERVER REQUIREMENTS

- ✓ Hard disk space: 10 MB

#### **2.1.2.2.2 SECUREADMIN LITE CLIENT REQUIREMENTS**

- ✓ Hard disk space: 25 MB

#### **2.1.2.2.3 MICROSOFT .NET FRAMEWORK 3.5 SP1 REQUIREMENTS**

- ✓ Hard disk space: Up to 600 MB might be required

#### **2.1.2.2.4 SUPPORTED OPERATING SYSTEMS**

SecureAdmin Lite Server and SecureAdmin Lite Client support these operating systems:

- ✓ Windows Server 2003 R2
- ✓ Windows Server 2008
- ✓ Windows Vista
- ✓ Windows XP Service Pack 2 or higher
- ✓ Windows 7 32-bit and 64-bit

#### **2.1.2.2.5 SQL SERVER 2008 EXPRESS EDITION**

- ✓ Hard disk space: 350 MB of available hard-disk space for the recommended installation. Approximately 425 MB of additional available hard disk space for SQL Server Books Online, SQL Server Mobile Books Online, and sample databases.
- ✓ During installation of SQL Server 2008, Windows Installer creates temporary files on the system drive. Before running setup to install or upgrade SQL Server, verify that at least 2.0 GB of disk space is available on the system drive for these files
- ✓ Actual Hard Disk Space Requirements: 280 MB for the recommended installation.

#### **2.1.2.3 NETWORK REQUIREMENTS**

- ✓ The 4G Lite devices function on 100 baseT networks.

#### **2.1.2.4 SOFTWARE REQUIREMENTS**

Both SecureAdmin Lite Server and SecureAdmin Lite Client require these software applications as prerequisites:

- ✓ .net Framework 3.5

- ✓ Windows Installer 4.5
- ✓ SQL Server 2008 Express Edition

If these applications are not already installed, they will get installed during the setup process. SecureAdmin Lite Server and SecureAdmin Lite Client also require System Administrator access to install the application.

SecureAdmin Lite uses a self-signed certificate (x.509 certificate) with a file extension of .pfx as default certificate. Certificate is installed on both SecureAdmin Lite Server and SecureAdmin Lite Client components.

You have the option of installing your own certificate, which must be purchased from a recognized authority in advance. In case of custom certificate, it should be first installed on the PC. During SecureAdmin Lite Server & Client installation, you need to provide name and other details of the custom certificate.

## **2.1.3 UNPACK EQUIPMENT**

Unpack all items and check against the packing list.

### **2.1.3.1 PARTS LIST**

#### **2.1.3.1.1 4G V-FLEX LITE, 4G CR-PASS**

##### **Hardware**

- ✓ Qty 1 - 4G V-Flex Lite device or 4G CR-Pass device
- ✓ Qty 1 – Stainless Steel Wall mounting plate
- ✓ Qty 2 - #4-8 1" nylon wall anchors
- ✓ Qty 2 - #6 1" Philips pan-head self-tapping screws
- ✓ Qty 1 – Fiber washer
- ✓ Qty 2 - #6-32 3/4" Philips pan-head screw
- ✓ Qty 1 – 6-32 Security Screw 1/8 pin-in-hex 1/4" length
- ✓ Qty 1 – Cable, MicroUSB Device Cable
- ✓ Qty 1 – Cable, MicroUSB PC Cable
- ✓ 1 Ethernet ferrite core

## Tools

- ✓ Qty 1 - 1/8" pin-in-hex security key 2.5

### 2.1.3.1.2 4G SECURECONTROL

#### Hardware

- ✓ Qty 1 - 4G SecureControl device
- ✓ Qty 1 – Terminal Block, 1x12, 3.5mm
- ✓ Qty 1 – Terminal Block, 1x14, 3.5mm
- ✓ Qty 1 – Antenna, Omni Plug Connector (for WLAN option)
- ✓ Qty 4 - #4-8, 1" nylon wall anchor
- ✓ Qty 4 - #6, 1" Philip pan head self-tapping screw
- ✓ 1 I/O Lines ferrite core for 14-pin terminal block cables (for WLAN option only)

### 2.1.3.1.3 DOCUMENTATION

#### 4G V-Flex Lite and CR-Pass:

- ✓ 1 Installation Guide (on Installation CD)
- ✓ 1 Operator's Manual (on Installation CD)
- ✓ 1 Quick Start Guide (on Installation CD and printed copy in package)

#### 4G SecureControl:

- ✓ 1 Quick Start Guide (printed copy in package)

The documentation is provided in Adobe Acrobat format (PDF). The Adobe Acrobat Reader application is available on the Installation CD or at: <http://www.adobe.com>

## 2.1.4 CHOOSING THE INSTALL LOCATION

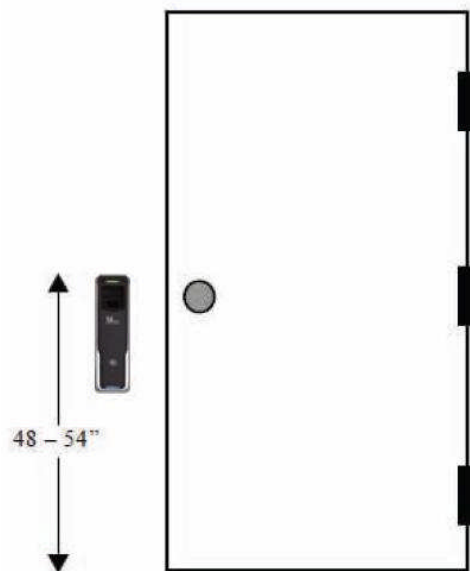
### 2.1.4.1 4G V-Flex Lite and CR-Pass

4G V-Flex Lite and CR-Pass devices are designed to mount on either a single-gang electrical box or on any flat surface. Consult with local professionals regarding any building and safety codes that might affect your installation. The correct mounting height is shown below.

Factors to consider when determining the position of a device on the wall:

- ✓ Proximity to other switch plates or fixtures (the device should ideally be mounted in-line with other plates or fixtures)
- ✓ Distance from the floor to the top of the device (L-1 Identity Solutions recommends using a height between 48 and 54 inches).
- ✓ The device should be mounted on the knob side of the door
- ✓ Compliance with the Americans with Disabilities Act if in the United States. Information about <http://www.usdoj.gov>.

Figure 2-1 Correct Mounting Height



### 2.1.4.2 4G SecureControl

SecureControl devices can be used in combination with any 4G Lite devices (up to quantity of 4) for control of up to 2 physical doors. SecureControl devices are also designed to be placed on the secure side of the installation. SecureControl must be placed in an area that is

accessible only by Administrators and not by users during normal operation. Some examples of installation options for SecureControl include:

- Fastened or securely placed in the ceiling
- Wall-mounted

All of the above scenarios are valid given that the location is on the secure side of the installation.

### 2.1.5 PLAN DEVICE NETWORK

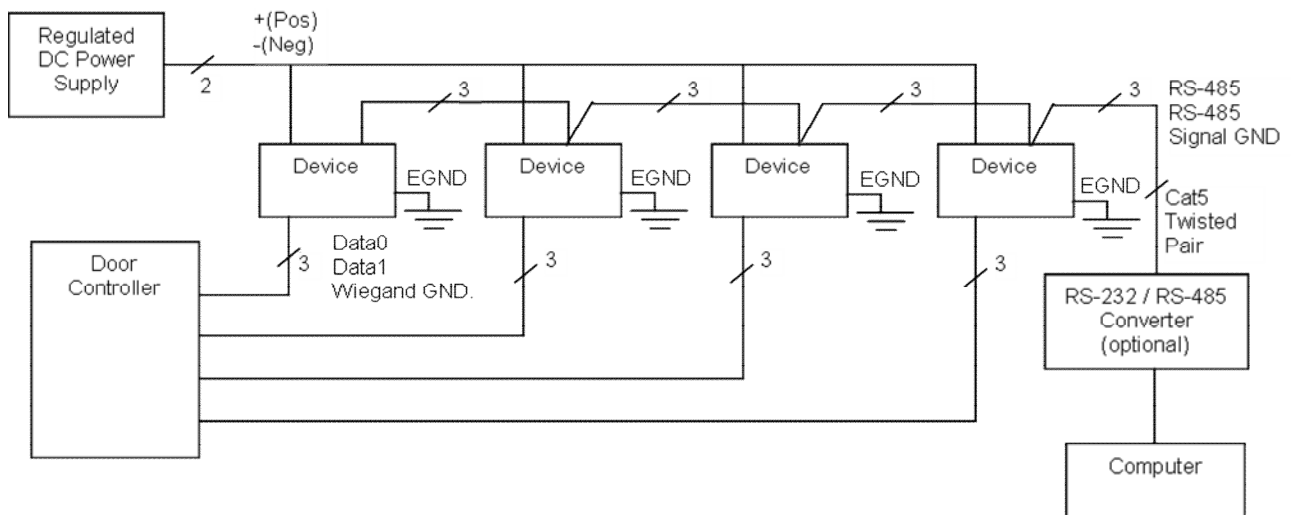
The 4G Lite devices feature a built-in single-door relay that allows them to control a single door lock. They can therefore function on their own or as part of a larger access control system.

System component selection is specific to each installation, but a minimum system would consist of a 4G V-Series device mounted on or near an access point, an electric lock, and cabling.

A more complex system might consist of devices at multiple access points (each with an electric door lock), a multi-point controller, networking, and a PC to run the access controller and SecureAdmin Lite Server software.

See the diagram below for an example (non-Ethernet) system diagram.

Figure 2-2 Example RS-485 System Diagram



Installation of locks and access controllers should be completed according to their respective manufacturers' specifications and in accordance with all local codes. Final connections to the device are explained in more detail in Chapter 4.

To avoid externally generated transients, do not run any wires near utility AC power wiring, lightning rod grounding wire, etc. Grounding equipment is required for ESD protection and safety.

## 2.1.6 CHOOSE NETWORK TYPE

If your installation requires the use of network communications, then the choice of cable, the cable run length, the network topology, and the termination of the network are important aspects that must be considered. The 4G V-Flex Lite and CR-Pass devices can be networked using RS-232, RS-485, or Ethernet protocols.

The table below outlines relevant parameters of the RS-485, RS-232, and 100 baseT Ethernet communication protocols.

Table 2-1 Communications Network Comparison

<b>Spec</b>	<b>RS-485</b>	<b>100BaseT</b>
Mode of Operation	Differential DC Coupled	Multi
DC Isolation	No	No
Maximum Distance	4000 feet	330 feet
Number of Devices on one line	31	Unlimited
Maximum Data Rate	57600 bps (recommended)	Auto-negotiated

### 2.1.6.1 RS-485

RS-485 has two distinct advantages over the more common RS-232. First, it allows you to connect up to 31 4G V-Series devices to a PC with an external RS-232 to RS-485 converter (available from L-1 Identity Solutions). Second, the RS-485 specification allows for cable run lengths up to 4000 feet (1200 meters) at modest baud rates.

An RS-485 network is required instead of RS-232 if:

- ✓ Multiple devices must be connected together so that templates can be distributed among the devices
- ✓ The installation has only a single device, but it is over 150 feet (45 meters) from the host PC.



### 2.1.6.1.1 RS-485 CABLE SPECIFICATION

4G V-Series devices provide a 2-wire, half-duplex RS-485 interface. The main cable run should be low capacitance, twisted-pair cable, with approximately 120 ohm characteristic impedance. Category-5 rated communications cable is used in RS-485 networks and its characteristics are defined below. This is the recommended cabling for RS-485 communications. The cable connection includes a differential line (A and B) and a GND connection.

Table 2-2 Category 5 Cable Characteristics

Specification	Recommendation
Capacitance (conductor to conductor)	<20 pF/ft.
Characteristic Impedance	100 - 120 ohms
Nominal DC resistance	<100 ohms/1000 ft.
Wire gauge	24 AWG stranded
Conductors/Shielding	>2 pair (shielding is recommended)

### 2.1.6.1.2 RS-485 CABLE LENGTHS

As outlined in the RS-485 specification, the total length of the communication cable (adding up all of the segments of the run) should not exceed 1200 meters (4000 feet). Although the RS-485 specification calls for a maximum cable length of 1200 meters and provides a maximum baud rate well above that of the 4G device, a more conservative system should be configured to no more than 1000 meters and run at a baud rate of 9600 bits per second. After the network is configured and is running in a stable manner, the baud rate can be increased if faster network communications are desired.

Drops (down-leads, stubs, T-connections, etc.) to equipment are not recommended, but if required, should not exceed one foot) and should use the same cable recommended above. On a long stub, a signal that travels down the wire reflects to the main line after hitting the input impedance of the device at the end. This impedance is high compared with that of the cable and the net effect is degradation of signal quality on the bus.

### 2.1.6.1.3 RS-485 NETWORK TOPOLOGY

Communication cables for RS-485 should be laid out in a daisy chain configuration (See Figure 2-3). Long stubs or drop downs and the star configuration should be avoided because they create discontinuities and degrade signal quality. The star configuration usually does not provide a clean signaling environment even if the cable runs are all of equal length. The star configuration also presents a termination problem, because terminating every endpoint overloads the driver. Terminating only two endpoints solves the loading problem, but creates

transmission line problems at the unterminated ends. A true daisy chain configuration avoids these problems.


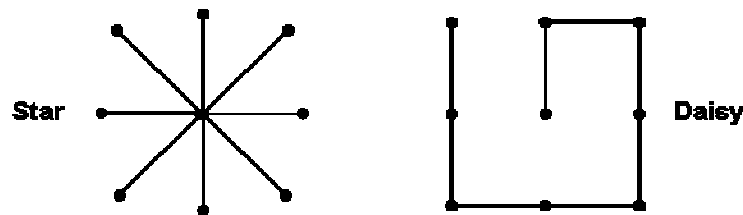

	<b>NOTICE</b>
	<p>The device on the end of the network should be terminated with a 120 ohm resistor.</p>

Figure 2-3 Network Topologies Star and Daisy Chain Configurations



	<b>NOTICE</b>
	<p>A Daisy configuration is recommended over a Star configuration.</p>

### 2.1.6.2 ETHERNET

If your system is to be configured for use over Ethernet, the wiring will be slightly different. Communication cables for Ethernet logically form a straight line bus but the more devices on that bus, the less efficient the network becomes due to increased collisions, and the weaker the signal will get over distance. Repeaters can be used to boost the signal strength; however, a better solution is to place switches at intermediate positions along the bus. The most common Ethernet topology in use today is the star configuration with a hub or switch in the center.

## 2.1.7 CHOOSE POWER SOURCE

4G V-Flex Lite, CR-Pass and SecureControl devices can be powered by several methods:

- ✓ 12V DC regulated (4G V-Flex Lite, CR-Pass and SecureControl)
- ✓ Power Over Internet (PoE) through an inline PoE 802.3af power injector (4G CR-Pass only)

Power sources should be:

- ✓ Isolated from other equipment
- ✓ Filtered
- ✓ Protected by an Uninterruptible Power Supply (UPS) or battery backup
- ✓ Protected by a voltage suppression device if transient electrical surges are an issue in the location.

When planning a system, know the power requirement of each device. If multiple devices are to share a common power supply, exercise care to avoid excessive voltage loss on the wires. Voltage loss can lead to communication problems when devices are talking and/or listening on different ground references.

Voltage loss is directly proportional to wire resistance and the current the wire carries. Always place the device as close as possible to the power supply and always select a wire size appropriate for the load. 4G Lite devices run on DC power between 12 V and 24 VDC.

Power requirements for all 4G V-Flex Lite, CR-Pass and SecureControl models are listed below:

Table 2-3 4G V-Flex Lite, CR-Pass, and SecureControl Power Requirements

Power Requirement:	12 watts
Input Voltage Range:	12-24.0 VDC
Peak Current (12 VDC)	1 A
Peak Current (24 VDC)	500 mA

Most power supplies on the market today provide good input and output isolation. However, power supplies which do not provide isolation (or have high leakage capacitance), coupled with accidental AC power line interchanges, present serious ground fault problems for installers. With a ground fault, the signal reference between subsystems may be 115 VAC apart. If these subsystems are interconnected, the large potential difference can cause equipment damage or personal injury. L-1 Identity Solutions recommends using a dedicated regulated DC power supply.

All factory-supplied power supply assemblies are either switching or regulated linear supplies and are isolated for safety and to minimize ground loop problems.

# CHAPTER 3 - INSTALL SOFTWARE

## CHAPTER OVERVIEW

This chapter shows how to install, repair, modify, upgrade, and uninstall the SecureAdmin Lite Server and Client software packages.

To install the SecureAdmin Lite software, the user must have Administrator rights. Any software required to install SecureAdmin Lite is detected and installed automatically during the setup process.

## 3.1 SECUREADMIN LITE SERVER

To install the SecureAdmin Lite Server software, follow these steps:

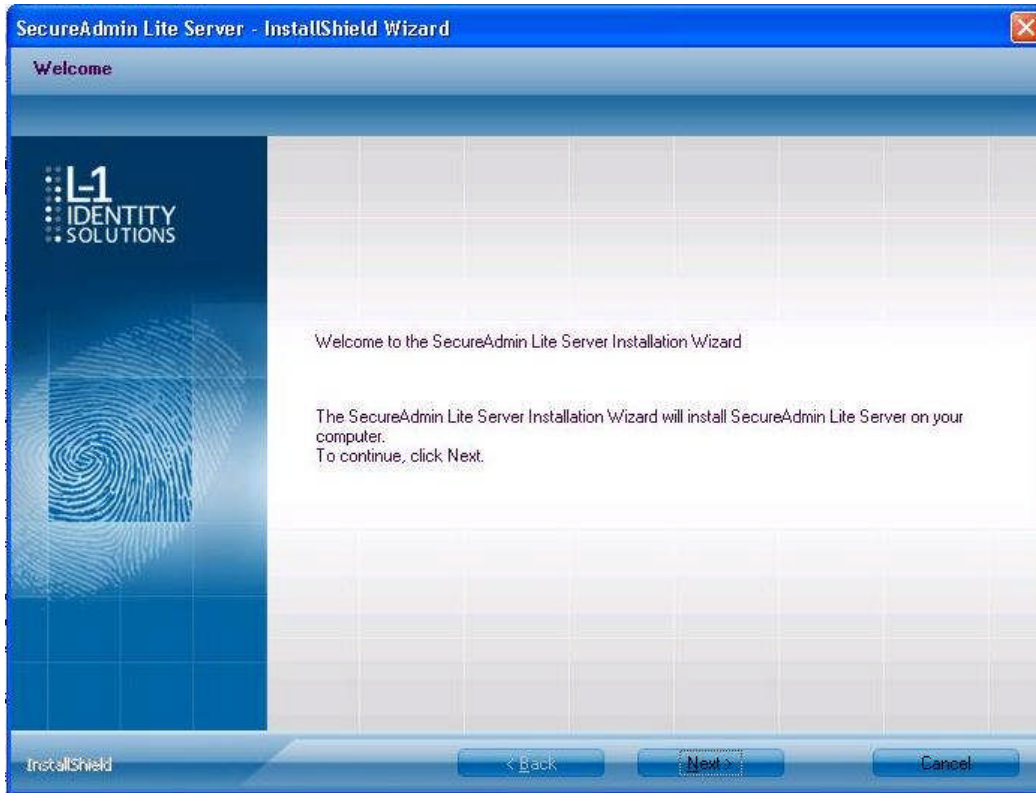
1. Insert the CD into the optical drive. If Autoplay is enabled, the installation process will start automatically. A menu is displayed. If Autoplay is not enabled, start the installation process manually by doubleclicking the Setup.exe file located in the "Bioscryptsetup" folder on the root of the CD.

Figure 3-1 Install Menu



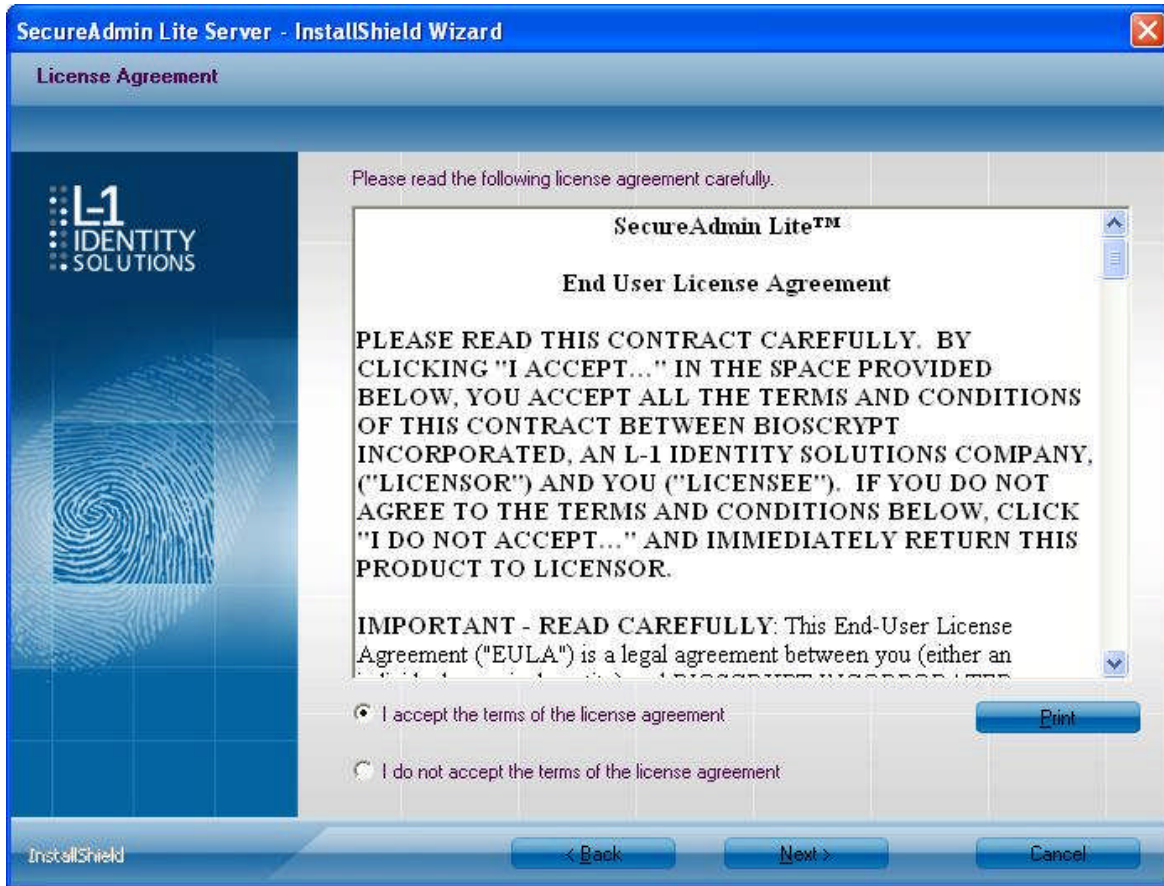
2. Click **Server Installation**.

Figure 3-2 SecureAdmin Lite Server Installation Wizard



3. The **Secure Admin Server Installation Wizard** is displayed. Click Next to continue the setup process.

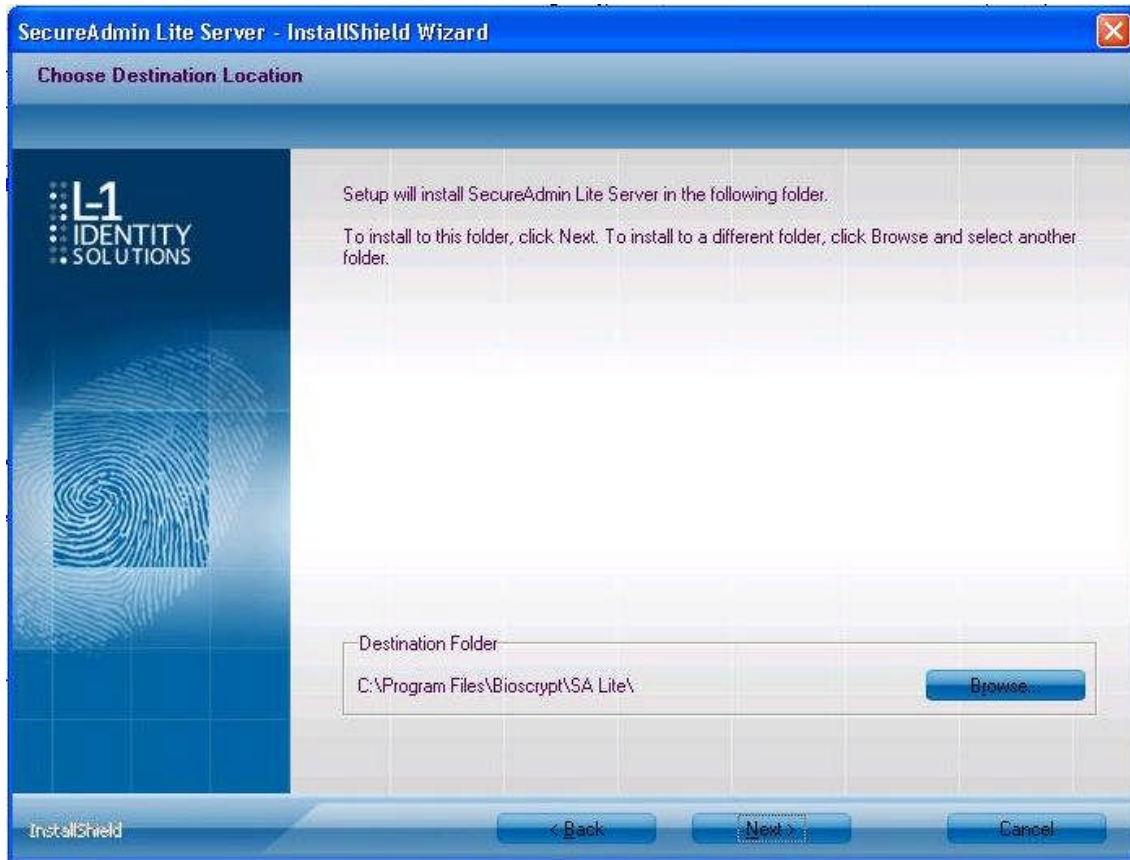
Figure 3-3 SecureAdmin Lite Server License Agreement



4. The L-1 Identity Solutions License Agreement is displayed. Select the appropriate radio button to agree with the terms and then click the **Next** button (You must accept the terms of the licence agreement to continue the installation process).



Figure 3-4 SecureAdmin Lite Server Choose Destination Location



5. The **Choose Destination Location** screen is displayed. Accept the default installation folder and click the Next button or click Browse to choose your own installation path. After you specify a destination folder, the Database Selection screen is displayed.

Figure 3-5 Database Selection

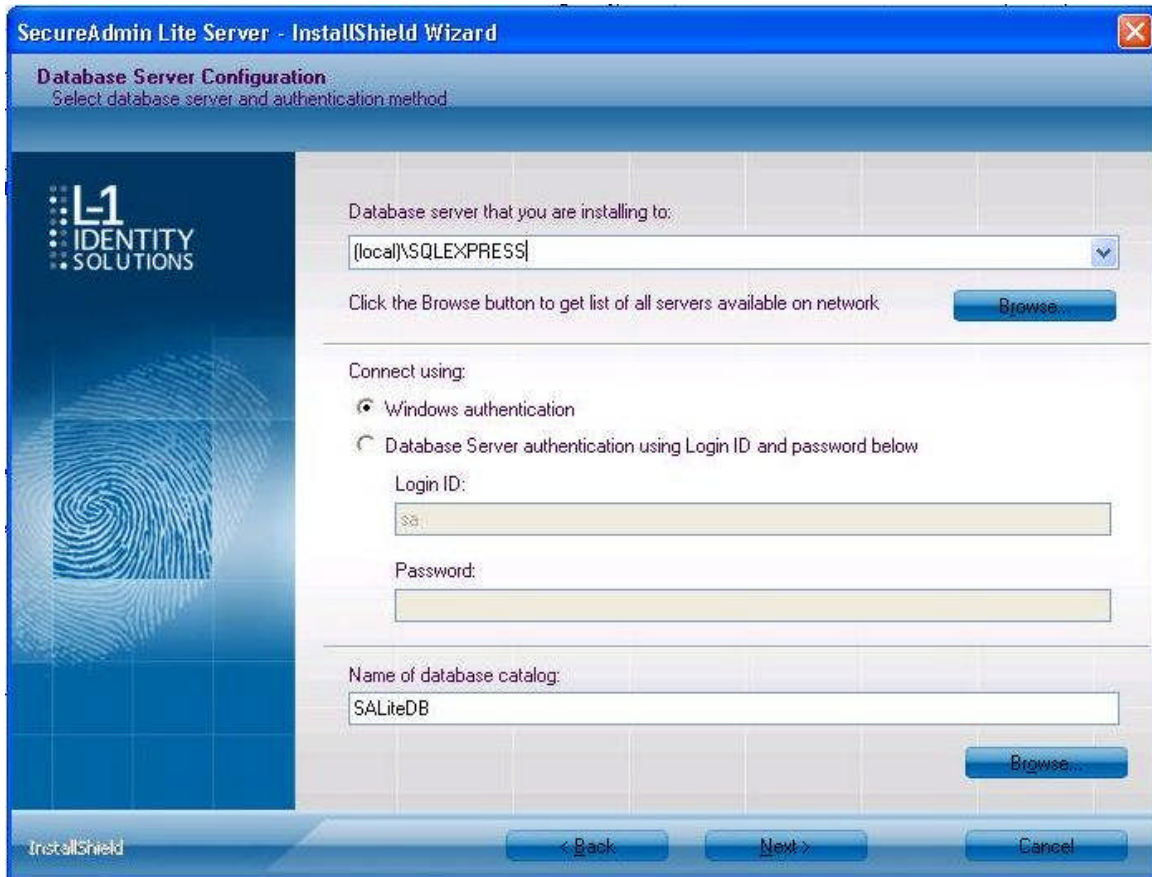


6. Using the radio buttons, select the type of database application you intend to work with, or select an existing database. Click the **Next** button.

If you selected the SQL Server 2008 Express Edition option, it will be installed locally if it is not already installed.

- ✓ Select **SQL Server 2008 Express Edition** option to install SQL Server 2008 on the local machine and Click **Next**.
- ✓ Select Windows **authentication or Database server authentication** option and enter a valid login ID and password values.
- ✓ Enter the **name of the database catalog** or click **Browse** to select an existing database catalog.
- ✓ Click **Next** to continue.

Figure 3-6 Connecting to SQL Server option



If you selected Connect to Existing SQL Server option,

- ✓ Select **Connect to Existing SQL Server** option and Click on Next.
- ✓ You can select existing database instance of SQL Server 2005 or SQL Server 2008 as required from the drop-down of **Database server that you are installing to**.
- ✓ Select the **Database server authentication** option and enter valid Login ID and password values.
- ✓ Accept the default database catalog or click **Browse** to select a different database catalog.
- ✓ Click **Next** to continue

### 3.1.1 REPAIRING AN INSTALLATION OF SECUREADMIN LITE SERVER

To repair an installation:

1. Login as **Administrator** and go to the Install.
2. Double-click the **Setup.exe** installer file to start the installer.
3. On the L1 Identity Solutions screen, select the **Server Installation** option.
4. On the **SecureAdmin Lite Welcome** screen, select the **Repair** option. Click **Next** to continue.
5. On the **Maintenance Complete** screen, click the **Finish** button to complete the repair installation process.

### 3.1.2 UNINSTALLING SECUREADMIN LITE SERVER

Uninstall SecureAdmin Lite Server by using either the **Add/Remove Program** function in Windows or by using the **Remove** option from the installation file as outlined below.

You can also uninstall SecureAdmin Lite Server by using the Remove option within the installation file. Follow the instructions above for repairing an Installation. Select the Remove option instead of the **Repair** option, then follow the prompts.

### 3.1.3 UPGRADING AN INSTALLATION OF SECUREADMIN LITE SERVER

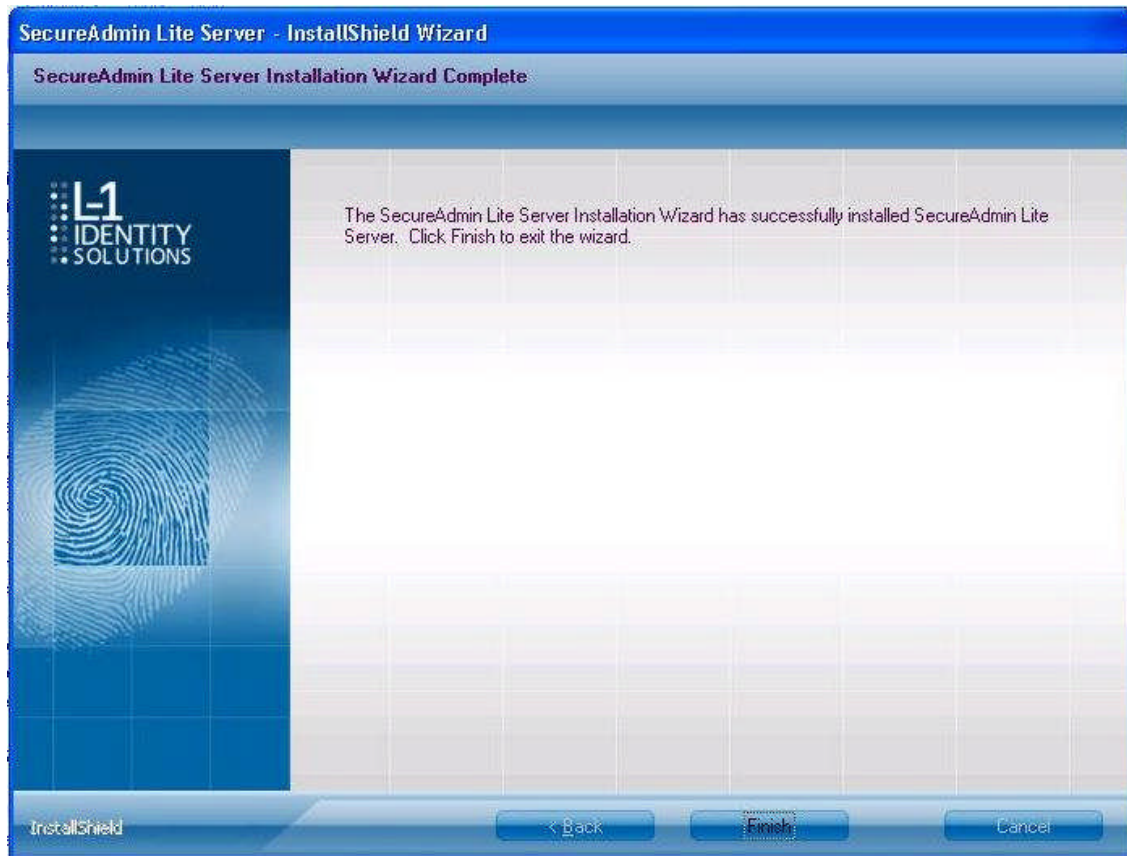
Installer of SecureAdmin Lite supports upgrading SecureAdmin Lite server from existing (currently installed) version to a newer one.

1. When you run the setup of SecureAdmin Lite server, it checks to see if previous version of SecureAdmin Lite server is already installed on the machine. If yes, it prompts to upgrade SecureAdmin Lite server. Click **Yes** to continue with upgrade install.

Figure 3-7 Upgrade Confirmation



Figure 3-8 SecureAdmin Lite Server Installation Complete



## 3.2 SECUREADMIN LITE CLIENT

To install the SecureAdmin Lite client software, follow these steps:

1. Insert the CD into the optical drive. If Autoplay is enabled, the installation process will start automatically. A menu is displayed. If Autoplay is not enabled, start the installation process manually by doubleclicking the **Setup.exe** file located in the SecureAdmin Lite folder on the CD.

Figure 3-9 Menu



2. Click **Client Installation**. The InstallShield Wizard is started and the target system is examined. The **Welcome** screen is displayed.

Figure 3-10 InstallShield Wizard

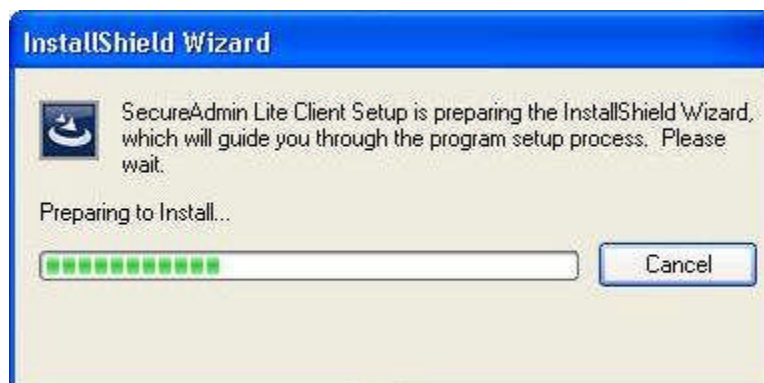
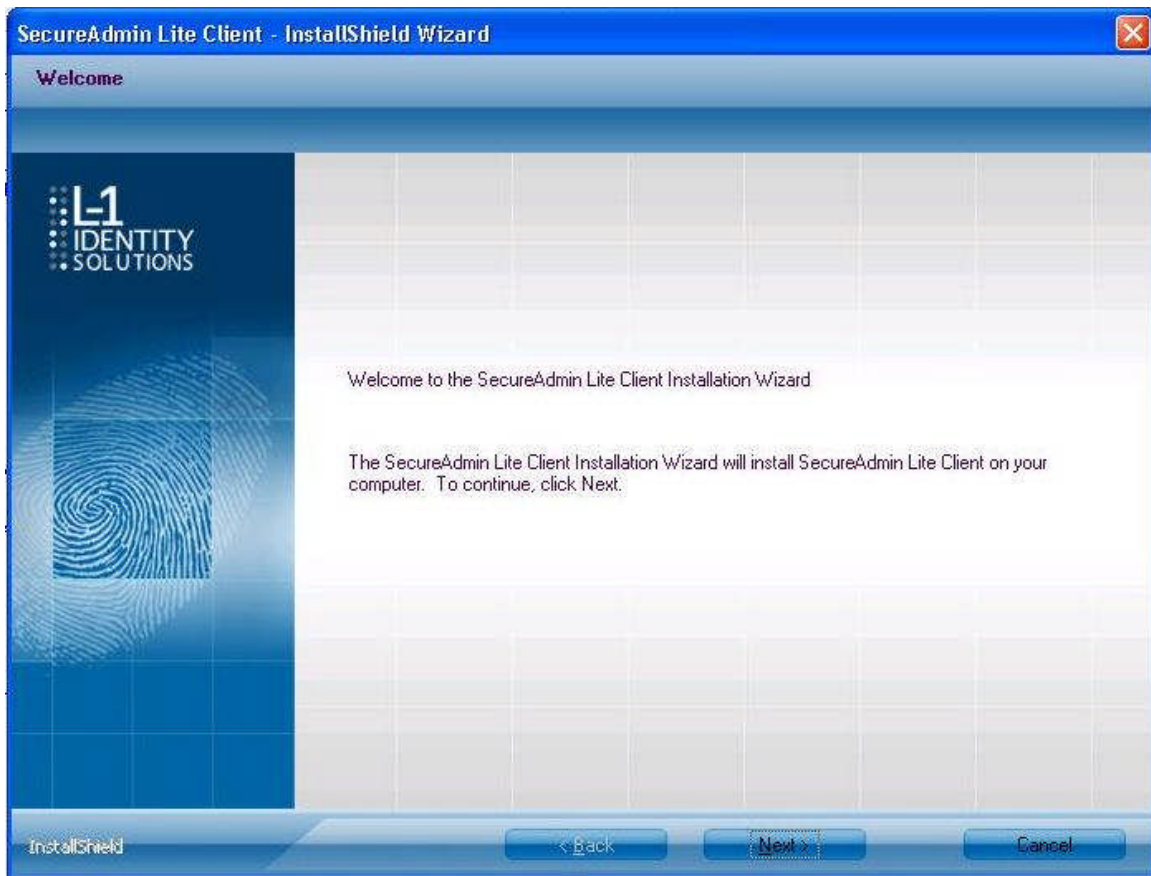
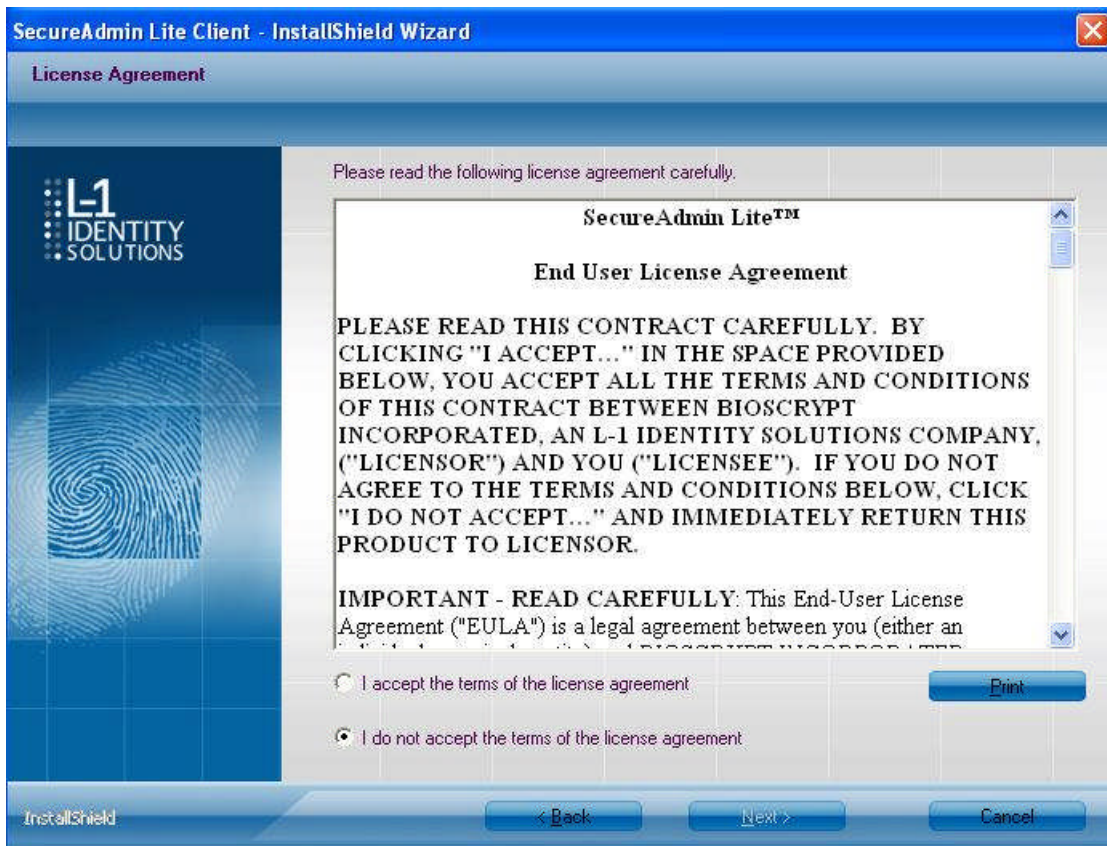


Figure 3-11 Welcome Screen



3. Click the **Next** button to continue. The **License Agreement** screen is displayed.

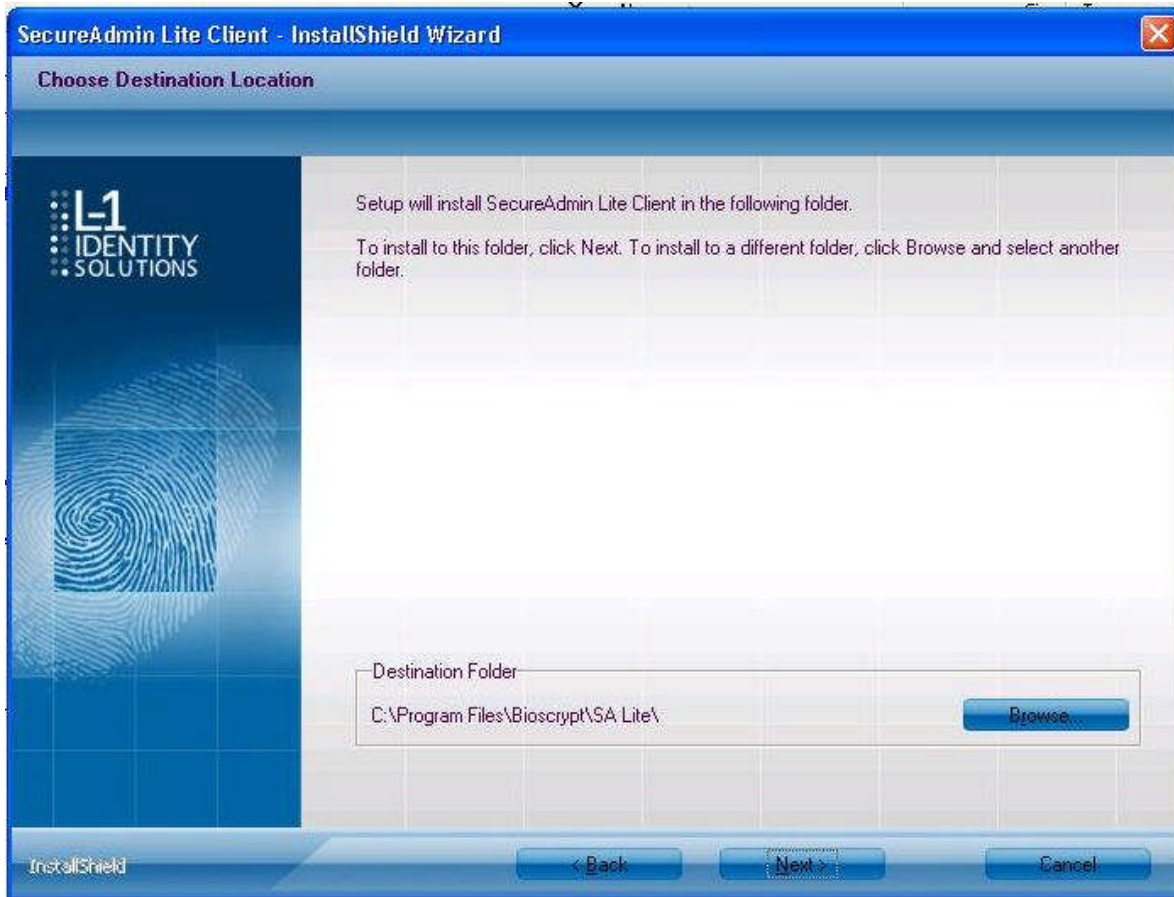
Figure 3-12 SecureAdmin Lite Client License Agreement



4. The L-1 Identity Solutions License Agreement is displayed. Select the appropriate radio button to agree with the terms and then click the **Next** button. The **Choose Destination Location** screen is displayed.

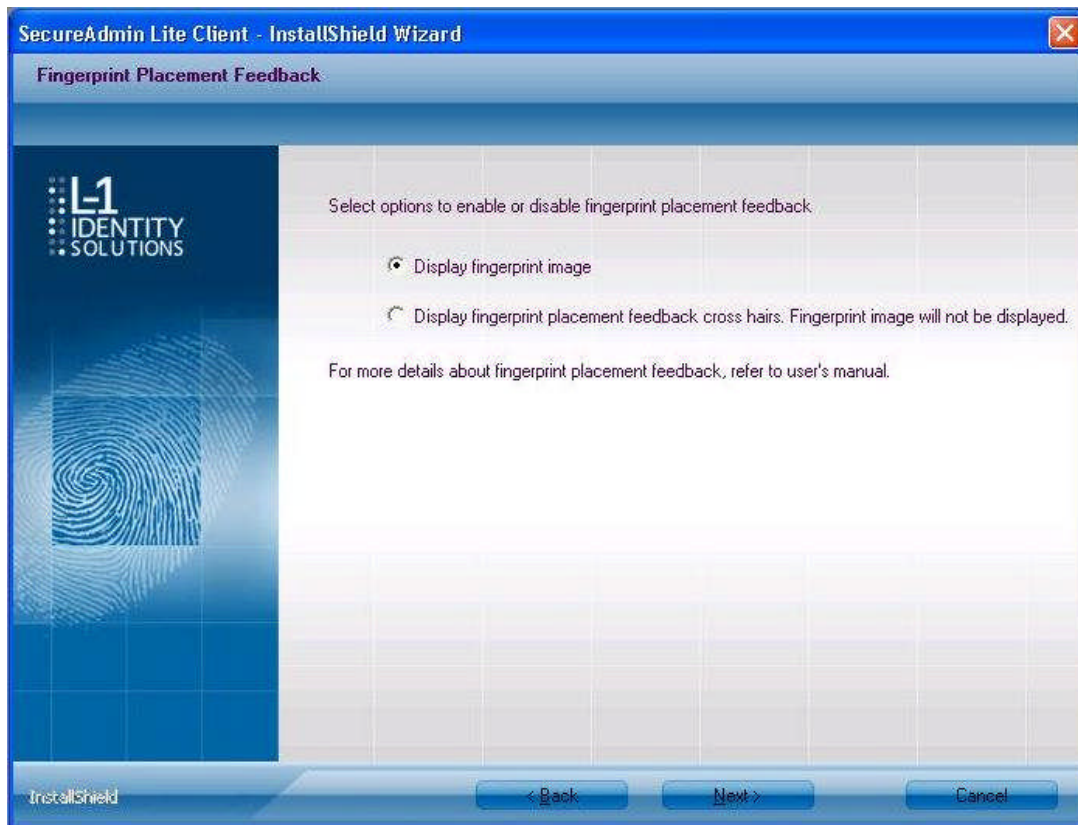


Figure 3-13 SecureAdmin Lite Client Choose Destination Location



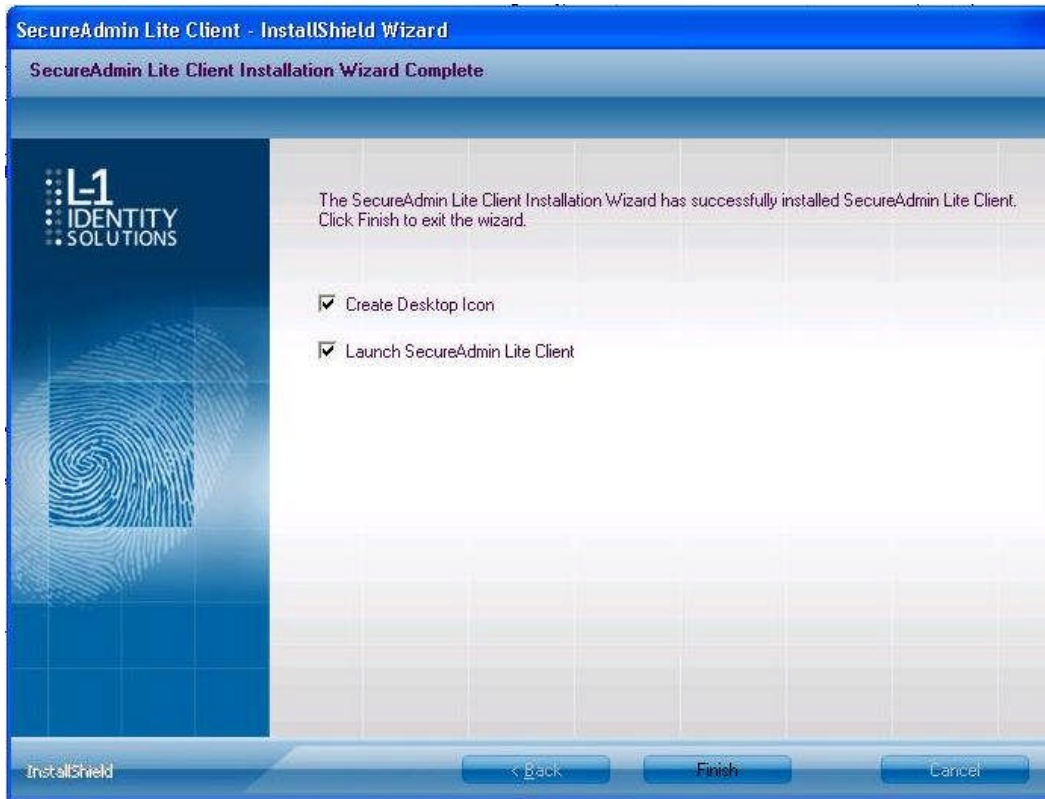
5. Accept the default installation folder and click the **Next** button or click Browse to choose your own installation path. After you specify a destination folder, the **Fingerprint Selection Feedback** selection screen is displayed.

Figure 3-14 Fingerprint Placement Feedback Option Selection



6. Select the appropriate radio button to either display or to not display fingerprint data. If **Display Fingerprint Image is selected**, a fingerprint will be displayed while enrolling templates. If the **Display Fingerprint Placement Feedback** option is selected, then SecureAdmin Lite displays crosshair placement feedback instead of fingerprint images while enrolling templates.
7. Click the **Next** button. The InstallShield Wizard completes the installation and displays a **Finished** screen.
8. Select either or both of the optional Check **Create Desktop Icon** and **Launch Secure Admin Client** check boxes.

Figure 3-15 InstallShield Wizard Finished



9. Click the **Finish** button.

### 3.2.1 MODIFYING AN INSTALLATION OF SECUREADMIN LITE CLIENT

To modify an installation:

1. Login as **Administrator** and go to the Secure Admin installer.
2. Double-click the **Setup.exe** installer file to start the installer.
3. On the L1 Identity Solutions screen, select the **Client Installation** option.
4. On the Secure Admin Welcome screen, select the **Modify** option. Click **Next** to continue.
5. Select the appropriate **Fingerprint Placement Feedback** option. If **Display Fingerprint Image** is selected, fingerprints will be displayed while enrolling templates. If **Display Fingerprint Placement Feedback** is selected, SecureAdmin Lite displays crosshair feedback instead of fingerprint images while enrolling templates.
6. Click **Next** to continue.
7. On the **Maintenance Complete** screen, click the **Finish** button to complete the modified installation.

### 3.2.2 REPAIRING AN INSTALLATION OF SECUREADMIN LITE CLIENT

To repair an installation:

8. Login as **Administrator** and go to the Secure Admin installer.
9. Double-click the **Setup.exe** installer file to start the installer.
10. On the L1 Identity Solutions screen, select the **Client Installation** option.
11. On the SecureAdmin Lite Welcome screen, select the **Repair** option. Click **Next** to continue.
12. On the **Maintenance Complete** screen, click the **Finish** button to complete the repair installation process.

### 3.2.3 UNINSTALLING SECUREADMIN LITE CLIENT

Uninstall SecureAdmin Lite Client by using either the **Add/Remove Program** function in Windows or by using the **Remove** option from the installation file.

To uninstall SecureAdmin Lite client by using the **Remove** option within the installation file, follow the instructions for repairing an installation. Select the **Remove** option instead of the **Repair** option, then follow the prompts.

### 3.2.4 UPGRADING AN INSTALLATION OF SECUREADMIN LITE CLIENT

To upgrade a previous version of SecureAdmin Lite Client, first uninstall the older version using Windows **Add/Remove Programs** or the SecureAdmin Lite installer, then re-install the new version of SecureAdmin Lite Client.

# CHAPTER 4 - INSTALL HARDWARE

## CHAPTER OVERVIEW

This chapter explains how to install a 4G Lite device, how to mount a wall plate, how to attach a device to a wall plate, and how to make the required electrical connections to the device.

### 4.1 WALL-MOUNTING SCHEMES

The 4G V-Flex Lite, 4G CR-Pass devices are mounted, by use of a mounting plate, either directly to a wall or to an electrical box recessed in the wall. The 4G V-Flex Lite and CR-Pass devices can be flush mounted on a wall.

4G SecureControl devices are designed to be placed on the secure side of the installation where it is only accessible by Administrators and not by users during normal operation (ie. in the ceiling or wall-mounted), hence there is no mounting plate required.

### 4.2 INSTALLING A MOUNTING PLATE

The procedure for mounting a wall plate directly to a wall is as follows:

#### 4.2.1 4G V-FLEX LITE AND 4G CR-PASS

1. Hold the mounting plate onto the wall in the desired location, trace the square hole that will be cut out, and mark the mounting screw locations.
2. Cut out the square hole with a jigsaw or drywall saw. If the 4G V-Flex Lite device is to be recess-mounted, cut out a hole in the drywall to accommodate the rear extension on the device housing.
3. Drill holes for the nylon wall anchors and install them.
4. Fish wires through the wall to the square hole.
5. Align the hole in the wall plate with the hole in the wall.
6. Fasten the mounting plate to the nylon wall anchors in the wall with the provided screws.



Figure 4-2 4G CR-Pass Flush-mount Mounting Plate (in mm)

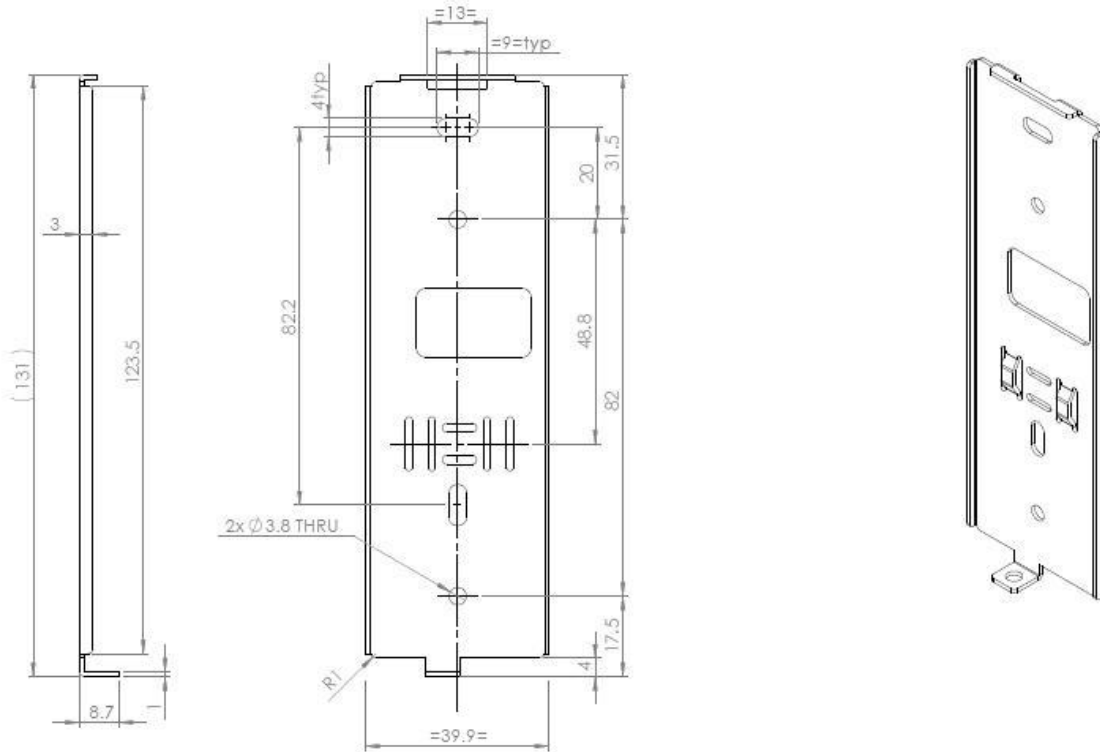
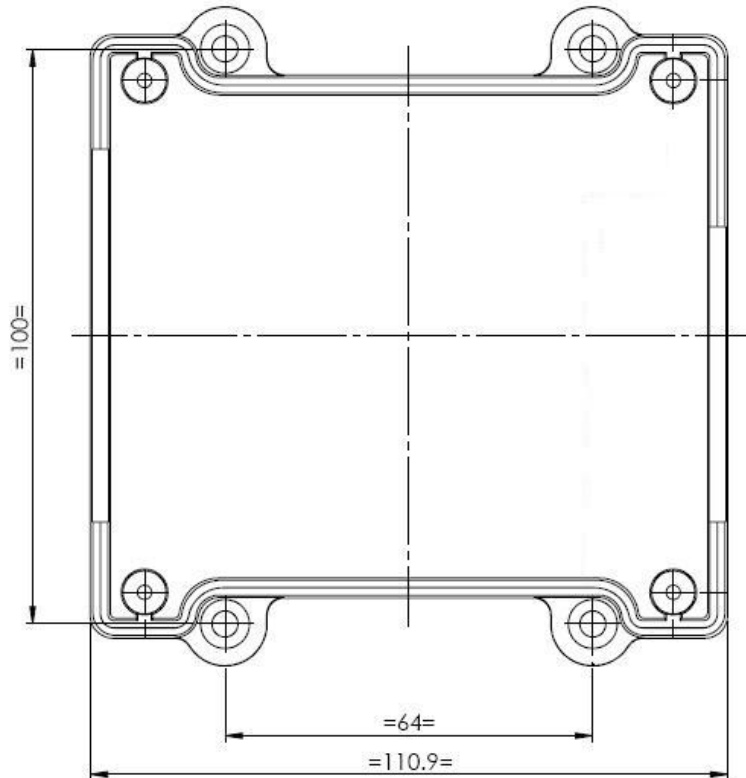


Figure 4-3 4G SecureControl Mounting Hole Locations (in mm)



## 4.3 INSTALLATION HARDWARE

### 4.3.1 4G V-FLEX LITE AND 4G CR-PASS Quantity

- ✓ Qty 1 – Stainless Steel Wall mounting plate
- ✓ Qty 2 - #6-32 3/4" Philips pan-head screw
- ✓ Qty 2 - #6 1" Philips pan-head self-tapping screws
- ✓ Qty 2 - #4-8 1" nylon wall anchors

The hardware listed above is provided to mount the mounting plate to the wall and the 4G V-Flex Lite or 4G CR-Pass device to the mounting plate.



## 4.4 ATTACH DEVICE TO MOUNTING PLATE

### 4.4.1 4G V-FLEX LITE AND 4G CR-PASS

Once all the electrical connections have been made to the device, it can be attached to the mounting plate as follows:

For the 4G V-Flex Lite and 4G CR-Pass, insert the hooked protrusions on the rear of the device into the corresponding slots on the mounting plate. Hold the device against the plate and gently press it in a downward direction to engage the hooks. Insert the star-shaped screw at the bottom center of the mounting plate and tighten with the wrench provided. Do not over-tighten.

## 4.5 CONNECT DEVICE TO POWER SOURCE

The 4G V-Flex Lite and 4G CR-Pass can be powered by 12V DC power source. The CR-Pass can be also powered through a Power over Ethernet (PoE) injector.

The two options for providing 12V power to 4G V-Flex Lite devices are by using an external wall plug-in adapter (Figure 4-11), or through external wiring and a mini plug (Figure 4-11).

Figure 4-4 Connections for an External Wall Adapter (4G V-Flex Lite)

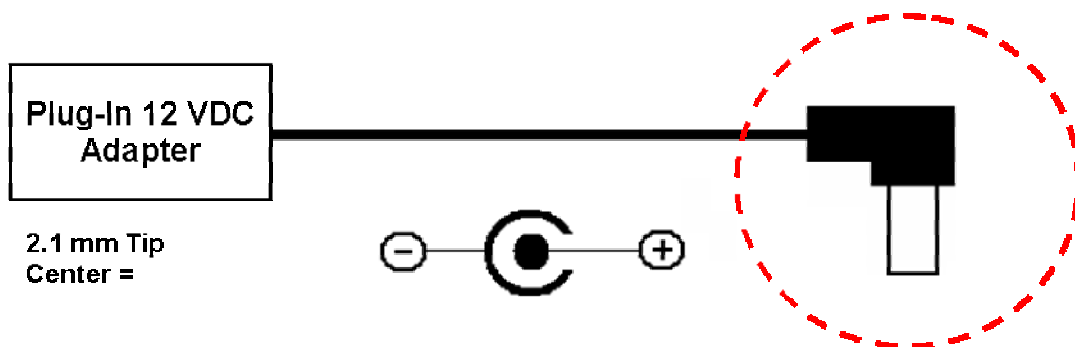
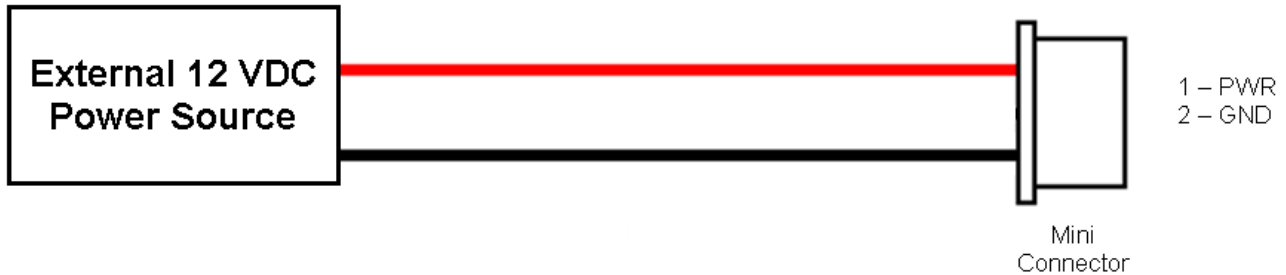


Figure 4-5 Connections for an External Power Source (4G V-Flex Lite)



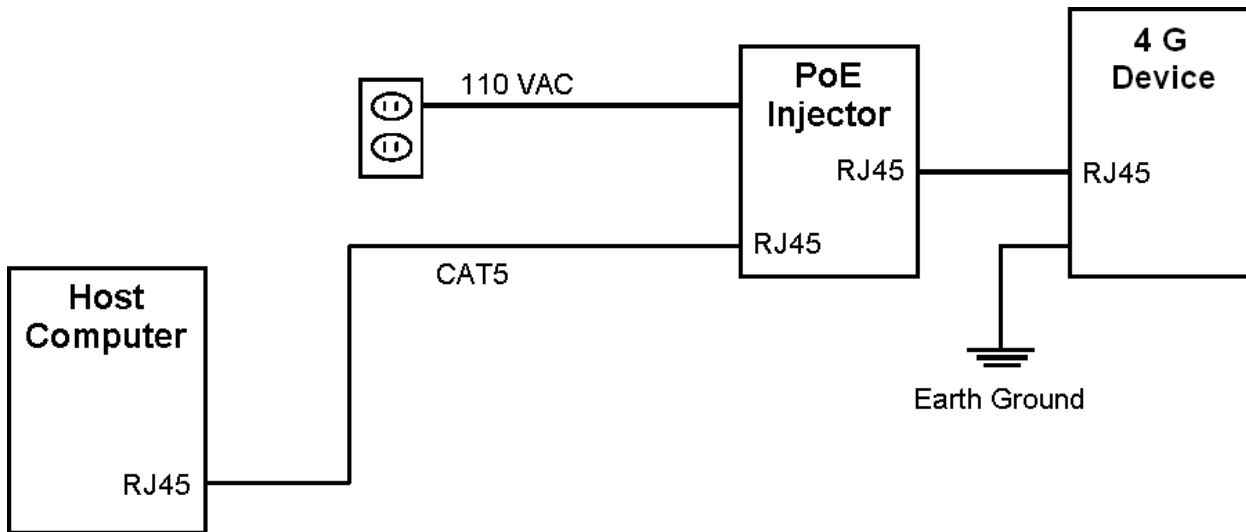
The 4G CR-Pass devices support Power over Ethernet (PoE), using their RJ-45 Ethernet interface. When these devices are to be powered over Ethernet, an IEEE 802.3af compliant Active Midspan Injector must be used. Such an injector is not supplied with L-1 Identity Solutions products. An example of a suitable PoE injector is Model No. AT-61 01 G from Allied Telesis Inc. (<http://www.alliedtelesis.com>).

Any such device should carry at least one of the certifications shown below and should be FCC listed.

Figure 4-6 Certification Marks



Figure 4-7 Power Over Ethernet Connection



Specifications for suitable PoE Injectors for 4G CR-Pass devices are as follows:

- ✓ Input voltage: 90-264 VAC, 60 Hz
- ✓ Input current: 0.4A @ 100 VAC
- ✓ Output voltage: 48 VDC
- ✓ Output current: 0.32A
- ✓ Power: 15.36 W

For Power over Ethernet, RJ-45 pin numbers 4, 5 are considered VB1 (+) positive DC supply, and pin numbers 7, 8 are VB2(-) DC return.

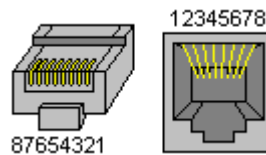
Detailed RJ-45 pin assignments for PoE are given in Table 4-1 PoE Pin Assignments, and the physical location of the pins in Figure 4-14 the RJ-45 connector.

Table 4-1 PoE Pin Assignments

STANDARD	SOURCE		LOAD		REMARKS
		Ethernet RJ-45 connector pin number			

	Source Voltage	1	2	3	4	5	6	7	8	Load Voltage	DC Load Connector	
IEEE 802.3af using spare pairs	48 V DC, protected	RX	RX	TX	DC+	DC+	TX	DC-	DC-	(embedded)		Industry Standard for embedded PoE

Figure 4-8 RJ45 Pin Location



## 4.6 CONNECT DEVICE TO NETWORK

The 4G Lite devices support RS-485, Ethernet 10baseT and 100baseTX protocols.

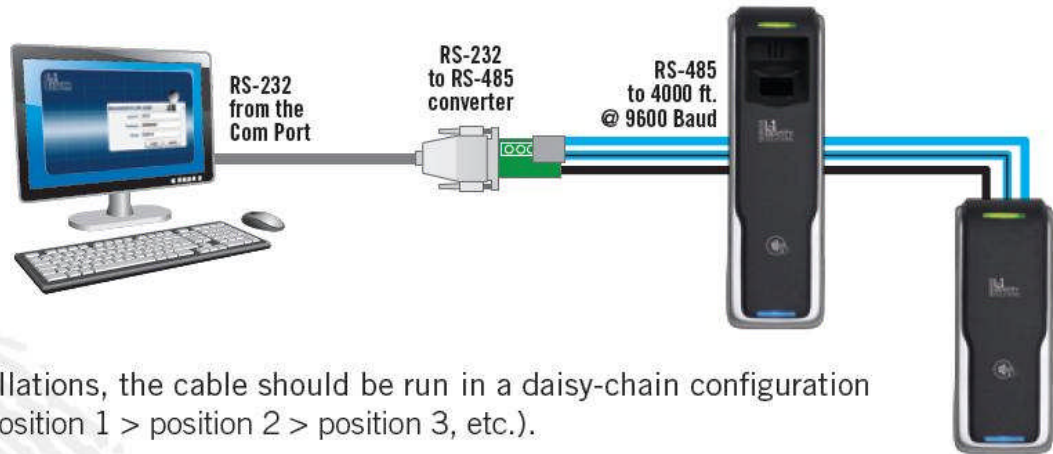
### 4.6.1 ETHERNET NETWORK CONNECTIONS

Ethernet connections to the device are made through a standard RJ-45 connector on the back of the device.

### 4.6.2 RS-485 NETWORK CONNECTIONS

To connect a device to an RS-485 network, connect the appropriate wires to the provided pigtail in accordance with the pin-out diagram.

Figure 4-9 4G V-Flex Lite and 4G CR-Pass - Pin-out Diagram



For RS-485 installations, the cable should be run in a daisy-chain configuration (i.e. converter > position 1 > position 2 > position 3, etc.).

Choose one twisted pair of conductors to use for RS-485A (Blue wire - Pin 17 of 26) and RS-485B (Blue/Black wire - Pin 19 of 26). Conductor should be used for RS-485\_GND (Black/Red) Pin 20 of 26.


When connecting the device to the network, the following procedures must be followed:

- ✓ Use Category 5 cabling with a characteristic impedance of 120 ohms for RS-485 networks. Category 5 cables with a characteristic impedance of 100 ohms can also be used, but with lower performance.
- ✓ Cable manufacturers provide cables with multiple twisted pairs designed for this type of communication (characteristic impedance is 120 ohm).
- ✓ Unused pairs within the cable must be terminated with characteristic impedance (100 or 120 ohm) on both ends.
- ✓ AWG 24 should be considered as the minimum gauge.
- ✓ Choose one twisted pair of conductors to use for RS-485 differential connections, other conductors should be used for Signal Ground (RS-485 GND on Weidmuller connection).
- ✓ The RS-232 to RS-485 converter must support Sense Data to be able to switch from Send to Receive mode.
- ✓ Check each device's cabling for ground faults before connecting to an RS-485 network.
- ✓ Each device should have pin 3 of the mini-connector connected to earth ground.


After all devices are configured and connected to the RS-485 network, the baud rate can be increased to the highest supported rate (some experimentation might be required).

## 4.7 SINGLE-DOOR CONTROLLER INSTALLATION

The 4G Lite devices incorporate an internal relay that enables them to operate a deadbolt/door strike directly.

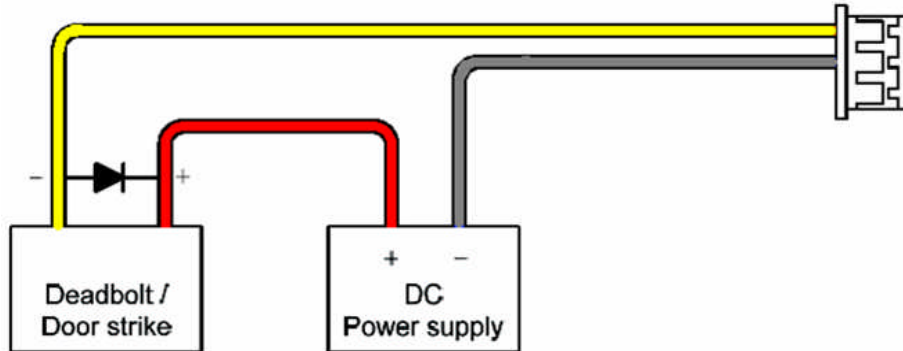
	WARNING
	<p>The internal relay is limited to a maximum current of 1A. If the deadbolt/ doorstrike to be controlled draws more than 1A, damage to the device may occur. If the deadbolt/door strike load exceeds 1A, an external relay must be used, as described below. Do not use the same power supply to power a 4G V-Series device and a door strike.</p>

Assuming the current drawn by the deadbolt/door strike is less than 1A, the connections between 4G Lite device, deadbolt/door strike, and power supply for the deadbolt/door strike should be made. Note that a snubber diode (1N4007 or equivalent) must be connected across the deadbolt/door strike to protect the DC power supply from inductive kickback.

	CAUTION
	<p>The snubber diode and DC power supply for the deadbolt/door strike are not supplied with the 4G Lite device. The power supply should be specified in accordance with the voltage and current requirements of the deadbolt/door strike, but it must be ensured that the current to operate the dead bolt/door strike does not exceed 1A.</p>

If the current required to operate the deadbolt/door strike exceeds 1A, an external relay must be used in conjunction with the 4G V-Series device. The external relay must be specified so that its contacts are rated to carry the current required by the deadbolt/door strike, and that the current required to operate its energizing coil is within the 1A capacity of the 4G V-Series device's internal relay.

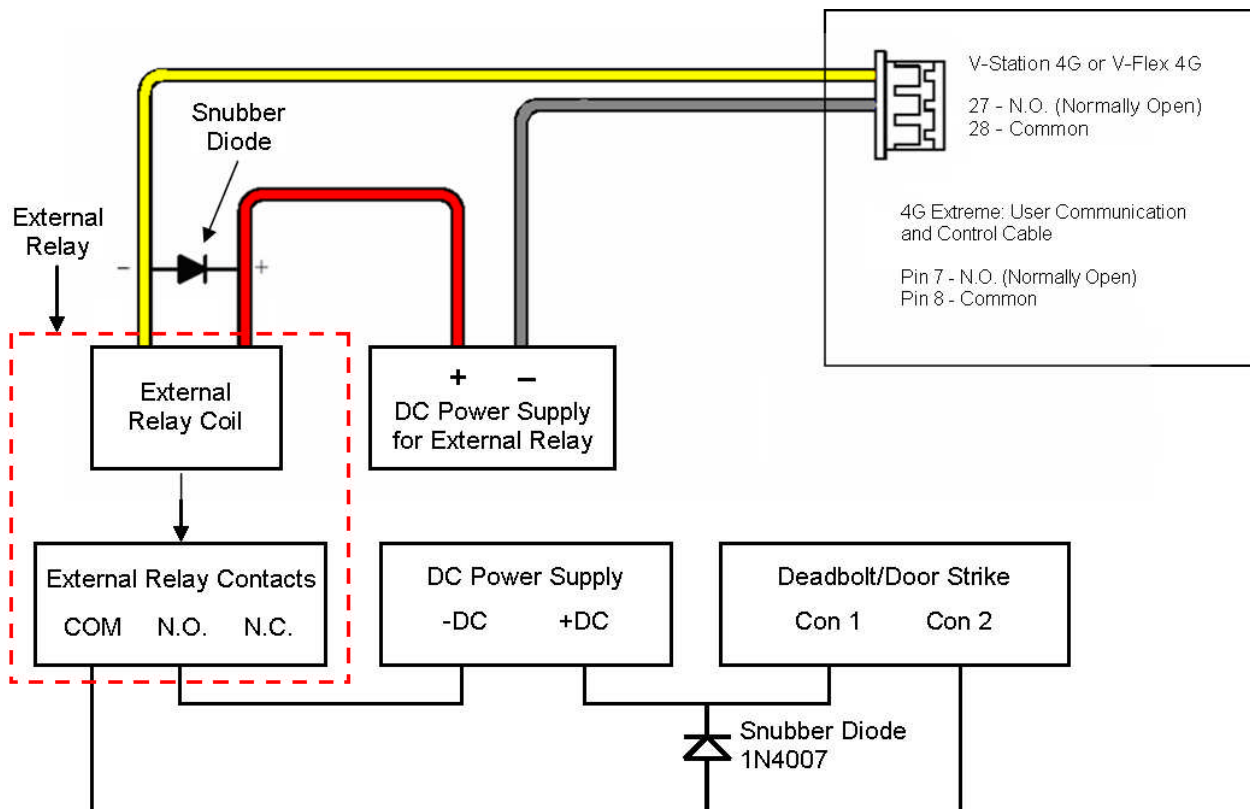
Figure 4-10 Connections for Internal Relay Operation



The power supply for the external relay must be chosen to match the operating voltage and current of the external relay coil, but its voltage must not exceed the 4G Lite device's internal relay maximum voltage rating of 250 volts.

The external relay should be connected. Note that snubber diodes (1N2007 or equivalent) should be connected across the external relay coil and the deadbolt/door strike.

Figure 4-11 Connections for External Relay Operation



## 4.8 AUX PORT

The Aux port is a USB 2.0 auto-negotiate connector located on the bottom of the device. To access the Aux port, the Aux port door must first be removed. Use the provided pin-in-hex security key to remove the #6-32 security screw retaining the plastic Aux port door. Gently remove the plastic Aux port door to reveal the USB connector.

To attach a USB memory key or other "gadget" serial device by way of the Aux port, use the USB Type A female to USB Micro A/B male adapter cable provided in the installation kit.

The Aux port is used to transfer files to and from the device. Audio (only on 4G V-Flex Lite devices), firmware, logs, and configuration files can be transferred quickly and easily to a device without the need for a computer.


	<b>CAUTION</b>
	Current rating of the Aux port is not to exceed 100 mA Maximum.



Figure 4-12 Location of Aux Port At the Bottom of the 4G V-Flex Lite

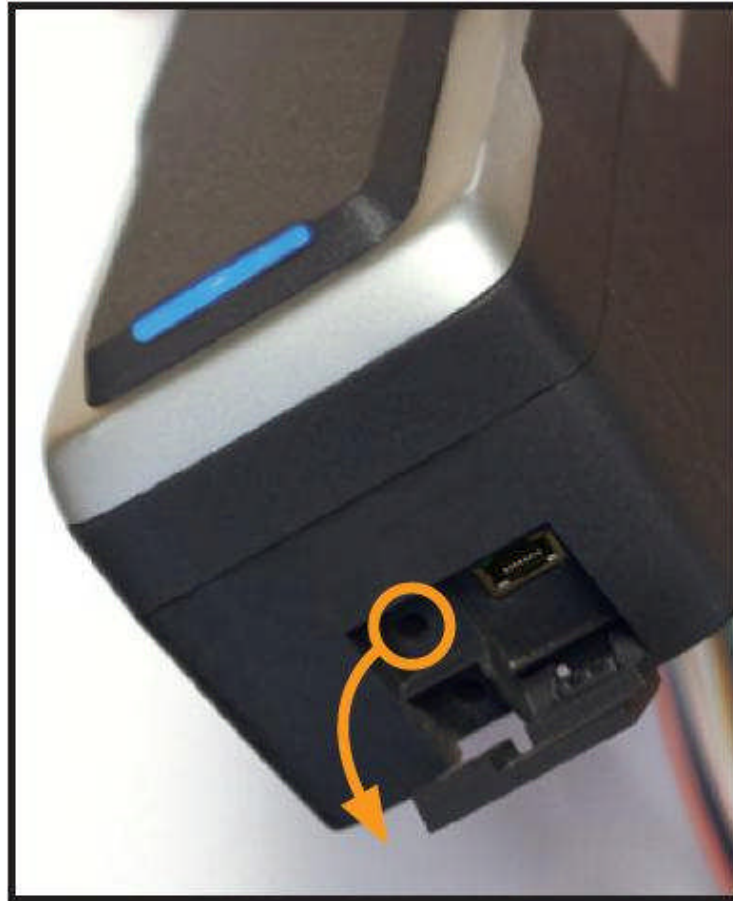


Figure 4-13 USB Memory Key



## 4.9 INSTALL FERRITE CORE

In order for the 4G Lite devices to comply with FCC Class B & CISPR 22 Class B regulations, the installer and/or end user is required to use the supplied Ferrite Material with 3 turns on the Ethernet cables exiting the rear of the 4G V-Flex Lite Base, 4G V-Flex Lite Prox and 4G CR-Pass Prox devices. In addition, compliance with the above regulations requires the

installer and/or end user to use the supplied Ferrite Material with 3 turns on the I/O lines for the 14-pin terminal block cables of the SecureControl device with WLAN option only.

Ethernet Ferrite P/N: STEWARD 28A2432-0A2

I/O Lines P/N: STEWARD 28A2432-0A2

Install the ferrite cores as close to the device as possible.

# CHAPTER 5 - SYSTEM START-UP PROCEDURES

## CHAPTER OVERVIEW

This chapter explains the various start-up procedures and checks that should be performed before applying power to a device.

## 5.1 SYSTEM START-UP PROCEDURES

To avoid the need for difficult troubleshooting, system start-up must follow this step-by-step procedure. Never wire up a system and apply power to it all at once.

### SYSTEM START-UP OVERVIEW

L-1 Identity Solutions recommends always following these system start-up steps:

1. Do not apply power to any device.
2. Check all wiring and device configurations.
3. Disconnect all devices from the communication line.
4. Check the supply voltage for correct voltage.
5. Power up the PC running SecureAdmin Lite.
6. Power up the RS-232 to RS-485 converter (if installed).
7. Configure SecureAdmin Lite.
8. Perform a ground fault check for the converter (if installed).
9. Connect the PC and converter (if installed) to the communication line.
10. Verify that the device powers up correctly, but do not connect it to the communication line. The power LED should be illuminated. Check the power lines with a voltmeter.
11. Perform a ground fault check for the device (if using RS-485, see below).
12. Connect the device to the communication line.
13. Verify that the device communicates with SecureAdmin Lite.
14. If there are more devices, repeat Steps 10 through 13 for each device.

### **5.1.1 DEVICE CONFIGURATION CHECK**

Devices must be configured correctly before they can communicate. Common problems include incorrect Host Port Protocol settings, mismatched Baud rates, and incorrect device Network IDs. Each device sharing a communication line must have a unique device Network ID.

### **5.1.2 RS-232 TO RS-485 CONVERTER GROUND FAULT CHECK**

Before a device can be connected to an RS-485 subsystem, it must be checked for ground faults. An uncorrected ground fault can damage all devices connected to the RS-485 communication line.

To check for a ground fault on the RS-232 to RS-485 converter:

1. Apply power to the RS-232 to RS-485 converter.
2. Connect the signal ground of the RS-485 line through a 10k ohm current-limiting resistor to the signal ground of the RS-232 to RS-485 converter. There should be no more than 1 volt across the resistor.

### **5.1.3 DEVICE GROUND FAULT CHECK**

To check for a ground fault on a new 4G Lite device:

1. Apply power to all devices already successfully connected to the RS-485 line.
2. Power up the new device but do not connect it to the RS-485 line.
3. Connect the signal ground of the RS-485 line through a 10k ohm current-limiting resistor to the signal ground of the 4G Lite device.
4. There should be no more than 1 volt across the resistor. If there is, find and clear the fault.
5. Repeat Steps 1 through 3 with each of the RS-485 signal lines (+ and -).
6. Connect the new device to the RS-485 line only if no ground fault is found.

# CHAPTER 6 - CONFIGURE DEVICE

## OVERVIEW

This chapter explains how to configure devices. All 4G Lite devices must be configured before use. This includes setting various communication parameters.

## 6.1 REGISTER DEVICE

After a device is physically installed, it must be registered. This can be done several ways -- when a device is connected by means of a network (this is the recommended method), or when the device is connected directly to the host computer upon which SecureAdmin Lite is running.

### 6.1.1 TO REGISTER A NETWORKED DEVICE

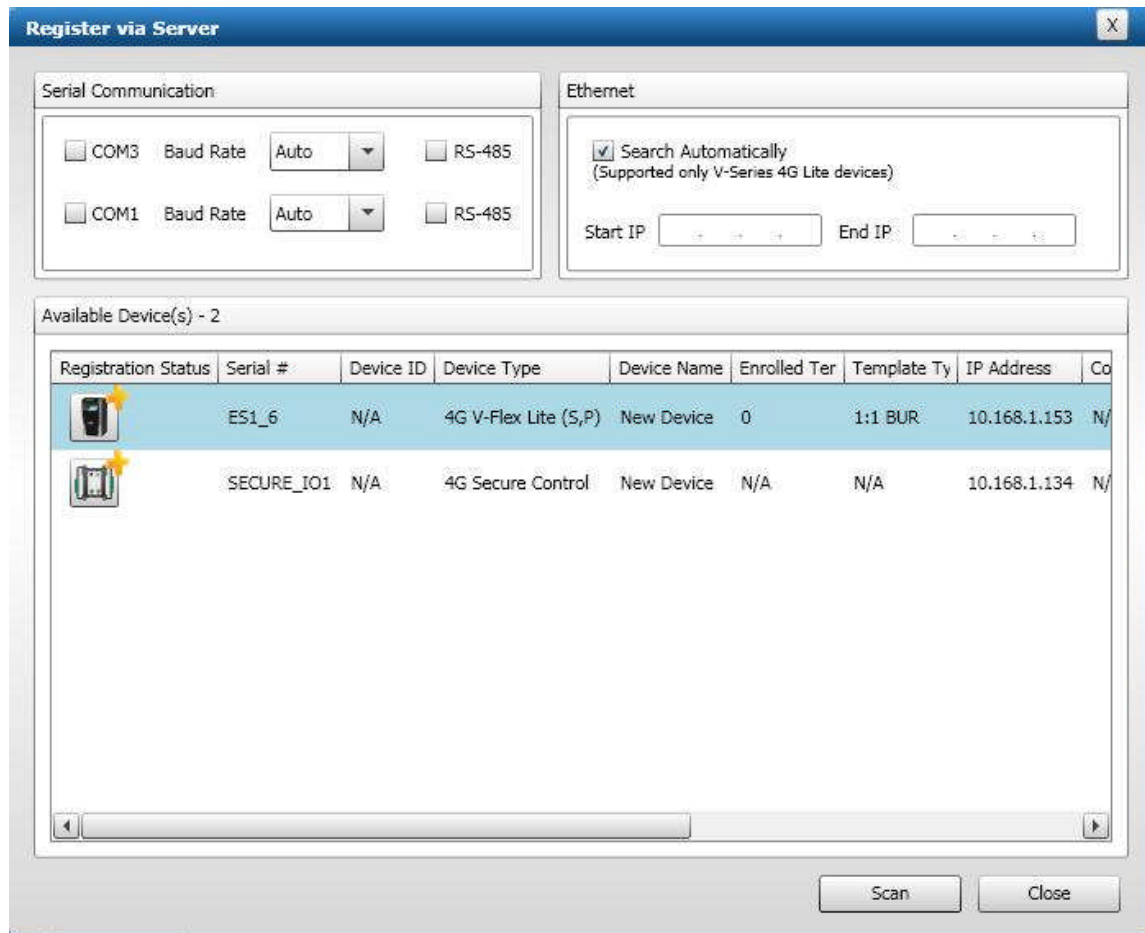
1. Launch SecureAdmin Lite.
2. Click the **Network** tab. Three buttons are displayed.

Figure 6-1 Network Sidebar Tab



3. Click the **Register via Server** button. A **Register via Server** dialog box is displayed.

Figure 6-2 Register via Server Dialog Box



4. Select the **Search Automatically** check box (UDP protocol must be enabled on the network).
5. Click the **Scan** button. SecureAdmin Lite scans the network for connected devices and lists the results. Devices with "plus" signs in their icon are available to add.

Figure 6-3 Server Communication Parameter



6. In the list, click the **icon of the device** you want to register. The server communication parameter dialog box is displayed. A **Register Device** dialog box is displayed. Select the **communication parameter** (if connecting via RS-232 or RS-485), enter the appropriate Port, Baud Rate, Device ID, and select the communication protocol from the drop-down. If connecting via enter the network IP address of the device (select the DHCP check box if dynamic IP addressing is used).

Figure 6-4 Register Device Dialog Box



7. Enter a **Device Name**.



8. Select a **Group**.
9. Click **Register**. A Device Summary is displayed.

Figure 6-5 Device Summary Dialog Box



10. Click **OK**.
11. Click **Close**. The device is registered.

## 6.1.2 TO REGISTER A DEVICE VIA A CLIENT

1. Launch **SecureAdmin Lite**.
2. Double-click the **Network** tab. Three buttons are displayed.
3. Click the **Register via client** button. The Step 1 Find Device dialog box is displayed.

Figure 6-6 Step 1 Find Device Dialog Box

The screenshot shows a dialog box titled "Step 1 of 5 Find Device". It has two main sections for finding a device. The first section, "Serial Port - this machine", is selected with a radio button. It includes a "Port" dropdown menu set to "3", a "Baud Rate" dropdown menu set to "Auto", and a "Device ID" text box containing "0" with an "Auto" checkbox. The second section, "Ethernet", is unselected. It includes an "IP Address" text box containing "10 . 168 . 1 . 153". At the bottom right, there are "Next" and "Cancel" buttons.

4. Select either **Serial Port - this machine** or **Ethernet** radio button.
5. Enter the appropriate connection details.

If you are connecting via USB/RS-232:


Enter the appropriate **Port Number** (to determine the correct port number, look in the Windows Device Manager for a "Gadget Serial" entry under the "Ports (COM & LPT)" heading), Baud Rate, and Device ID.

If you are connecting via RS-485:

Enter the appropriate **Port Number** (to determine the correct port number, look in the Windows Device Manager for your RS-485 entry under the "Ports (COM & LPT)" heading), Baud Rate, and Device ID.

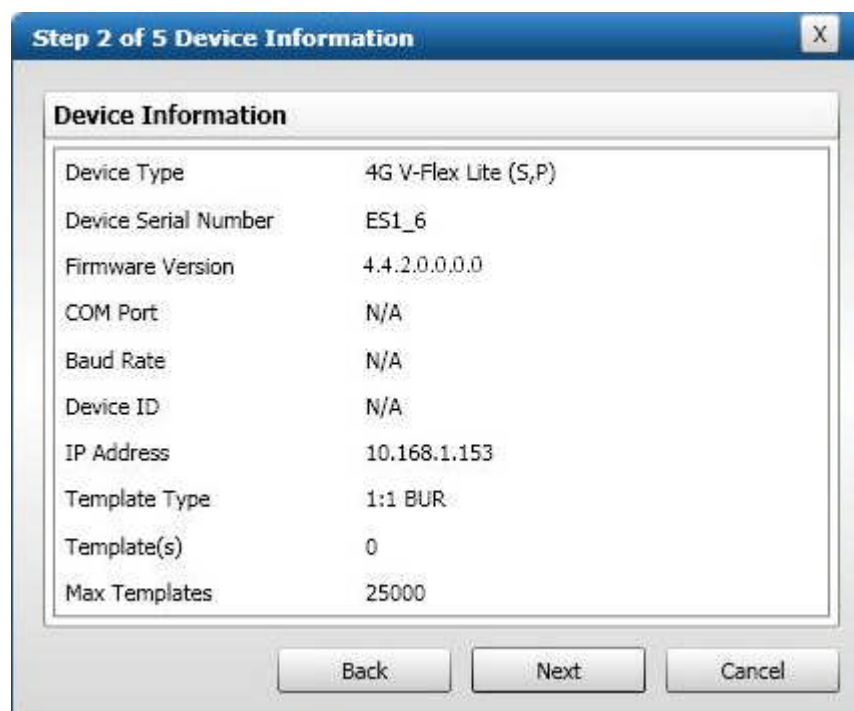
If you are connecting via Ethernet:

Enter the network **IP Address** of the device you want to connect to.

<b>NOTICE</b>	
	<p>The first time a 4G V-Flex Lite or 4G CR-Pass device is connected to the computer via the USB interface, the Windows Found New Hardware Wizard might start. As all required device drivers are installed when SecureAdmin Lite is installed, simply follow the prompts, accepting the default choices when possible, to install the device.</p>

6. Click **Next**. The Step 2 **Device Information** dialog box is displayed.

Figure 6-7 Step 2 Device Information Dialog Box



7. Click **Next**. The Step 3 **Server Communication Parameter** dialog box is displayed.

Figure 6-8 Step 3 Server Communication Parameter Dialog Box



8. Select the **radio button** that corresponds how the server will connect to the device, either by **Serial Port** or by **Ethernet**.
9. If connecting via RS-485, enter the appropriate **Port**, **Baud Rate**, and **Device ID** and select the communication protocol from the dropdown. If connecting via Ethernet, enter the network **IP Address** of the device (select the **DHCP** check box if dynamic IP addressing is used).
10. Click **Next**. The Step 4 **Register Device** dialog box is displayed.

Figure 6-9 Step 4 Register Device Dialog Box



11. Enter a **Device Name**.
12. Select the **Group** the device will belong to from the drop-down menu.
13. Click **Register**. The **Device Summary** dialog box is displayed.

Figure 6-10 Device Summary Dialog Box



# CHAPTER 7 - MAINTENANCE AND CLEANING

## CHAPTER OVERVIEW

This chapter explains how to clean the 4G V-Flex Lite device sensor.


The 4G V-Flex Lite devices require very little in the way of daily maintenance except for occasional cleaning and disinfecting.


## 7.1 CLEANING FINGER PRINT DEVICES

Sensors become soiled with residue, oils, or other contaminants due to contact with fingers and exposure to the elements. The sensor surface should be cleaned periodically for performance, aesthetic, and hygienic reasons. Care must be taken when cleaning the sensor to prevent damaging the sensor surface or surrounding components.

To clean the fingerprint sensor in a 4G V-Flex Lite device:

1. Remove the electrical power from the device.
2. Moisten (do not saturate) a clean cotton swab or a lint-free cloth with rubbing (Isopropyl) alcohol.

	<b>CAUTION</b>
	<p>Do not use chlorine based cleaners, such as bleach, or chlorine based bathroom or mildew cleaners. Chlorine-based cleaners will not adversely affect the fingerprint sensor, but they could damage the electronic circuitry surrounding the fingerprint sensor.</p> <p>Do not use solvents such as acetone, methyl ethyl ketone, lacquer thinner, etc. Solvents will not adversely affect the sensor, but they are likely to damage the reader housing or other peripheral components.</p>

	<b>WARNING</b>
	<p>Never use products such as abrasive cleaning powders, steel wool, scouring pads, or fine sandpaper to clean the sensor surface. These types of cleaning products will damage the sensor surface.</p>

3. Rub the sensor surface with the moistened cotton swab or lint-free cloth. Do not allow the cleaning product to drip onto any electronic components near the sensor.
4. Rub the sensor with a clean dry cotton swab or lint-free cloth to remove any traces of cleaning product.
5. Reconnect power to the device.



### **NOTICE**

Disposable ESD-safe wipes, such as ACL Staticide wipes, can be used to disinfect the sensor and buttons on a daily (or even more frequent) basis. Be aware that some wipes might not offer the same cleaning power as the products mentioned above and thus should not be relied upon to thoroughly remove all residue. Use of wipes does, however, help keep sensor and button surfaces hygienic and makes an excellent complement to periodic cleaning.

# CHAPTER 8 - TROUBLESHOOTING

## CHAPTER OVERVIEW

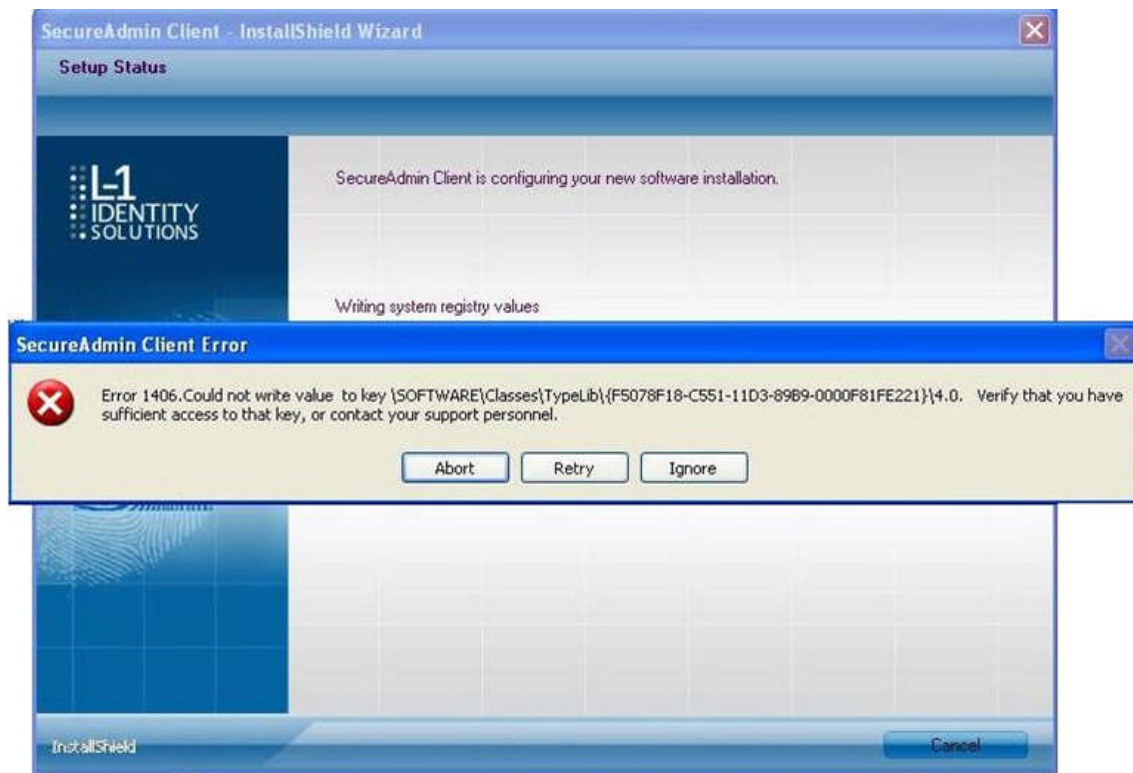
This chapter informs about error messages that might be experienced during the installation process.

### 8.1 INSTALLATION ERROR MESSAGES

These error messages might occur during the SecureAdmin Lite installation process.

#### 8.1.1 ERROR 1406 - INSUFFICIENT PRIVILEGES

Figure 8-1 Error 1406



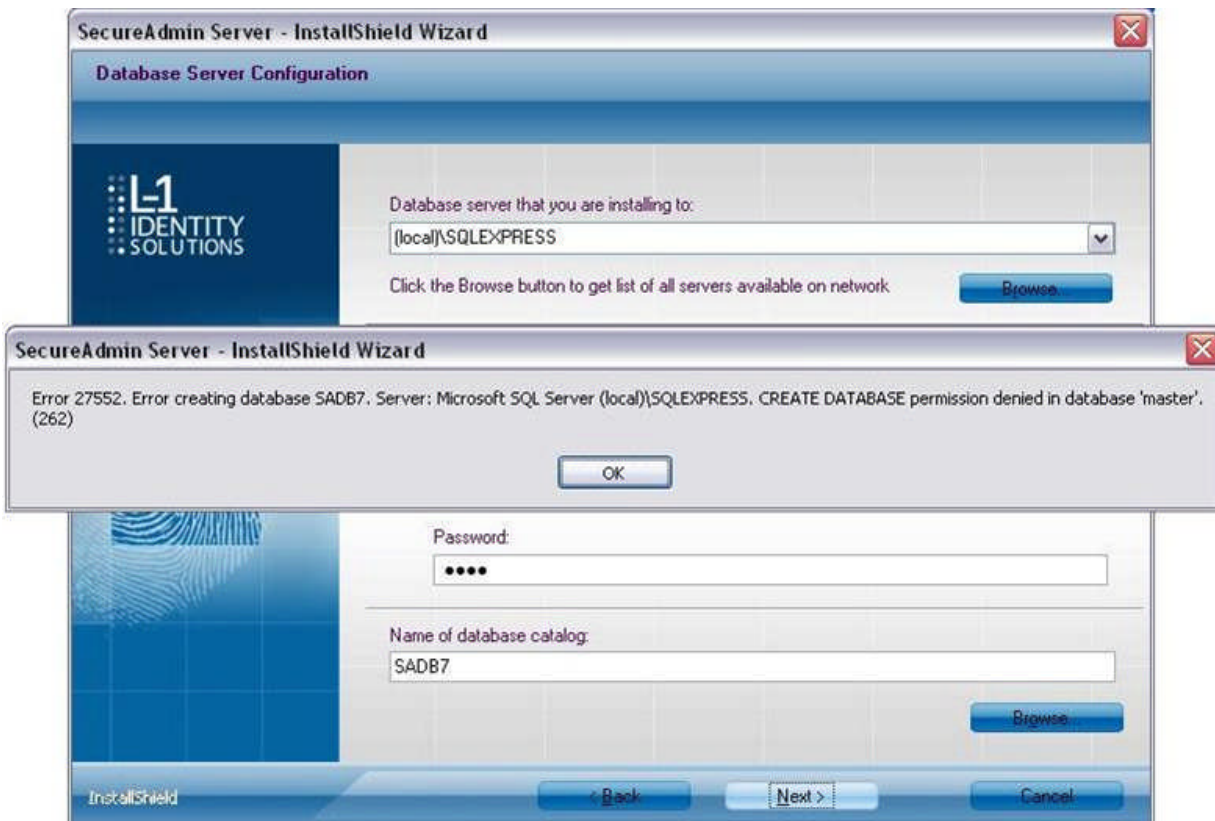
This error can occur during SecureAdmin Lite Client installation at the last step (right before "Finish"). If it occurs, it means that the user does not have sufficient rights to install software on the computer.



Log off and log on either as a Administrator or another user that has sufficient privileges to install software and perform the setup process again.

### 8.1.2 ERROR 27552 - ERROR CREATING DATABASE

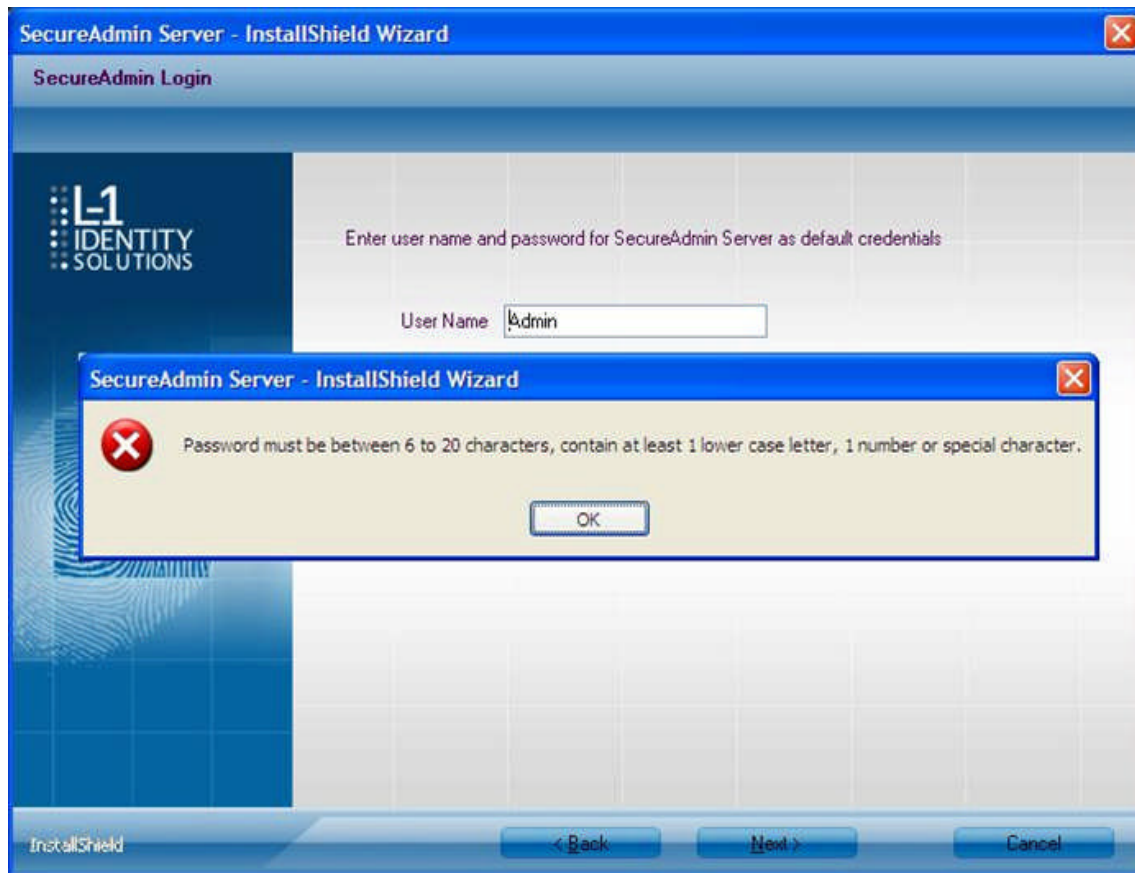
Figure 8-2 Error 27552



This error can occur during SecureAdmin Lite Server installation process. If it occurs, it means that the user does not have sufficient privileges to access a specific SQL database. Contact your IT department to ensure that your privileges are correct for the specified database.

### 8.1.3 INVALID PASSWORD

Figure 8-3 Invalid Password

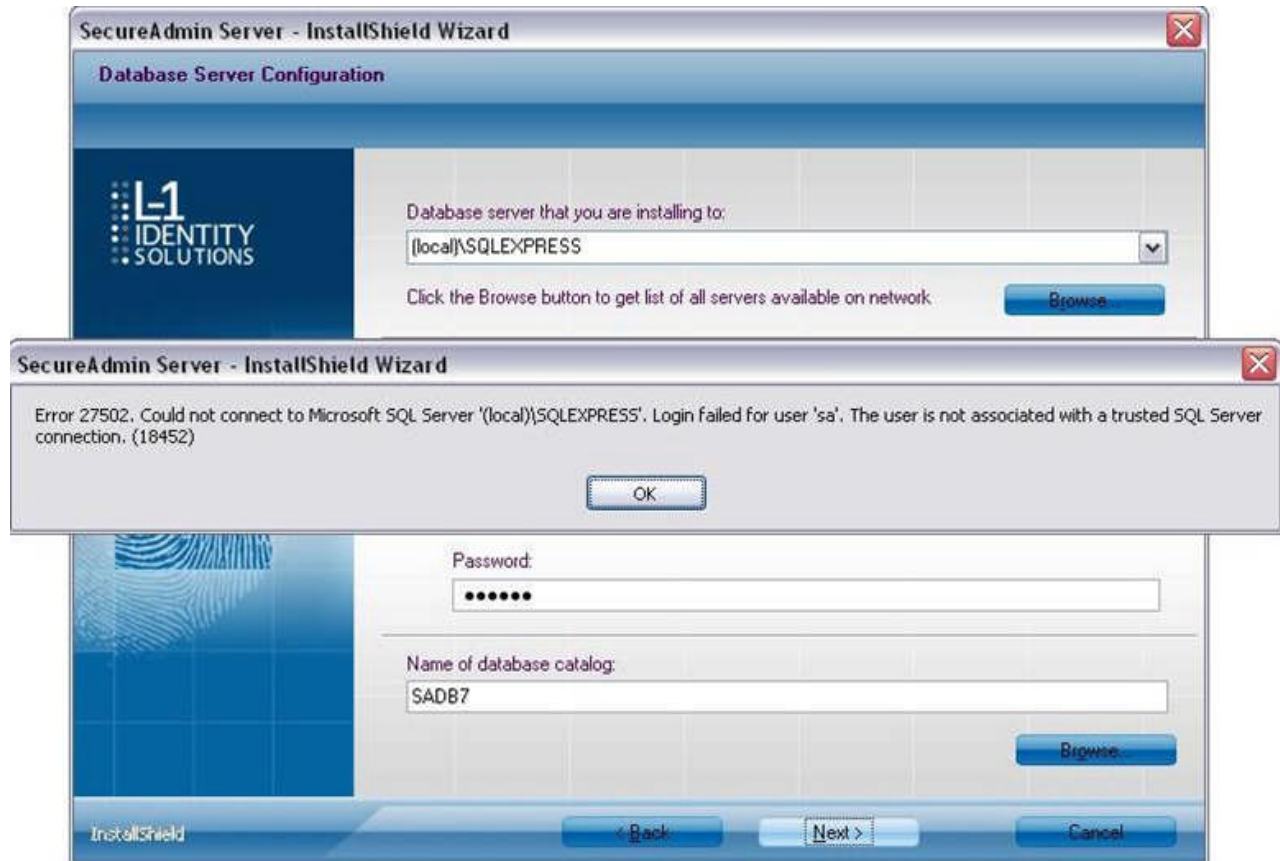


This error can occur during SecureAdmin Lite Server installation process on the User configuration screen (after the database configuration screen).

If it occurs, it means that the password provided is not strong enough. Click OK, and re-enter a password that is considered more secure. The password should be between 8 and 30 characters long and contain at least one capital letter, one number, and one non-alphanumeric character.

## 8.1.4 ERROR 27502 - USER NOT ASSOCIATED WITH TRUSTED SQL SERVER

Figure 8-4 Error 27502 - User Not Associated

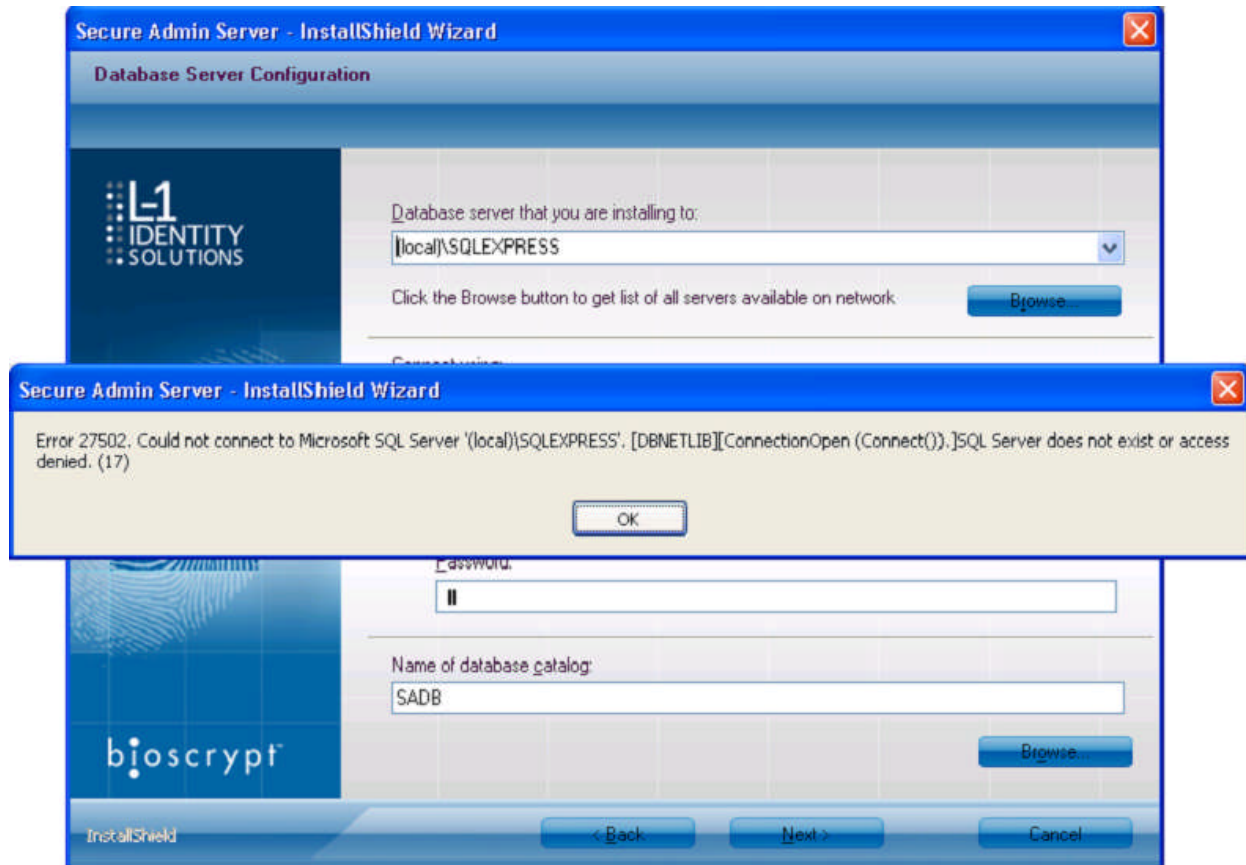


This error can occur during the SecureAdmin Lite Server installation process. If it occurs, it means that the InstallShield Wizard could not access the specified SQL database.

Check your user name and password or contact your IT department to ensure that your user name is associated with the specified SQL database.

## 8.1.5 ERROR 27502 - SQL SERVER DOES NOT EXIST

Figure 8-5 Error 27502 - Server Does Not Exist



This error can occur during the SecureAdmin Lite Server installation process (at the time of database configuration, after the database selection screen). If it occurs, it means that the InstallShield Wizard could not connect to the specified SQL database because it does not exist or because the user is not authorized to access that database

Check your user name and password or contact your IT department to ensure that your user name is authorized to access the specified SQL database.

## 8.1.6 INSUFFICIENT SYSTEM MEMORY

Figure 8-6 Insufficient System Memory

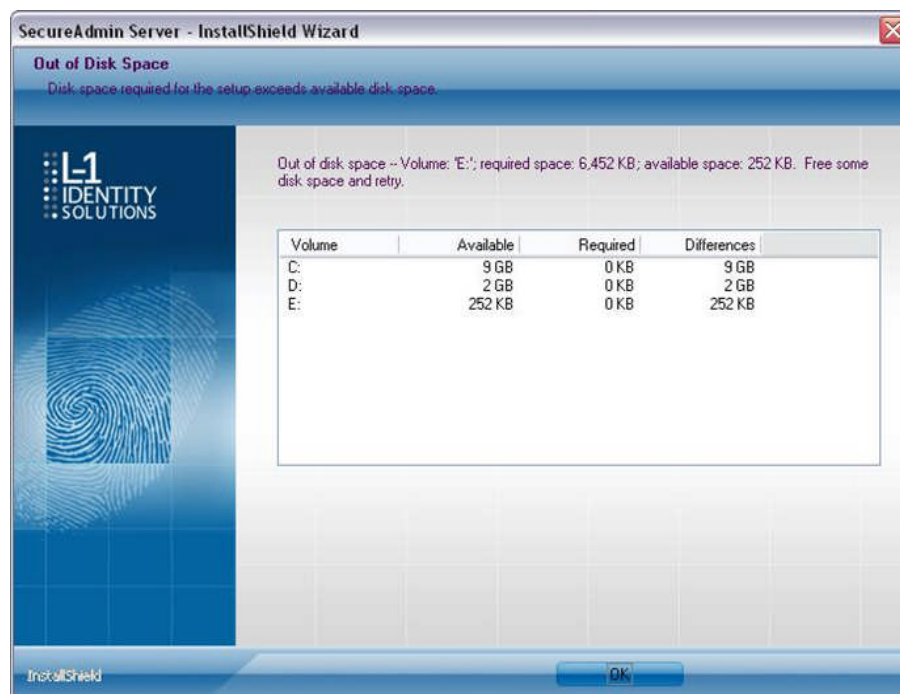


This error can occur during the SecureAdmin Lite Server installation process at the first screen after selecting server installation from the options screen.

If it occurs, it means that the computer you are trying to install SecureAdmin Lite Server on does not have sufficient system memory. Install more memory or install on a different machine.

## 8.1.7 OUT OF DISK SPACE

Figure 8-7 Out of Disk Space



This error can occur during the SecureAdmin Lite Client installation process when SecureAdmin Lite starts to configure components, after the fingerprint feedback options selection.

# CHAPTER 9 - NOTICES


## CHAPTER OVERVIEW


The 4G lines of products have been tested for compliance with all applicable international standards. The resulting approvals are listed below, and are additionally printed on the labelling located on the rear panel of the product.

4G V- Flex Lite	FCC, IC, CE
4G CR-Pass	FCC, IC, CE
4G Secure Control	FCC, IC, CE

## 9.1 FCC and IC Information to Users

This device complies with part 15 of the FCC Rules. Operation is subject to the following two conditions: (1) This device may not cause harmful interference, and (2) this device must accept any interference received, including interference that may cause undesired operation.

<b>NOTICE</b>	
	<p>This equipment has been tested and found to comply with the limits for a Class B digital device, pursuant to part 15 of the FCC Rules. These limits are designed to provide reasonable protection against harmful interference in a residential installation. This equipment generates uses and can radiate radio frequency energy and, if not installed and used in accordance with the instructions, may cause harmful interference to radio communications. However, there is no guarantee that interference will not occur in a particular installation. If this equipment does cause harmful interference to radio or television reception, which can be determined by turning the equipment off and on, the user is encouraged to try to correct the interference by one or more of the following measures:</p> <ul style="list-style-type: none"><li>- Reorient or relocate the receiving antenna.</li><li>- Increase the separation between the equipment and receiver.</li><li>- Connect the equipment into an outlet on a circuit different from that to which the receiver is connected.</li></ul>

	<b>énoncé de la FCC (états-Unis seulement)</b>
	<p>Cet équipement a été testé et jugé conforme aux limites de Classe B pour un appareil numérique, en vertu de l'article 15 de la réglementation de la FCC. Ces limites ont été instaurées pour fournir une protection raisonnable contre toute interférence nuisible dans une installation résidentielle. Cet équipement génère, utilise et peut émettre de l'énergie radiofréquence. S'il n'est pas installé et utilisé conformément aux instructions, il peut provoquer des interférences sur les communications radio. Cependant, il n'est pas garanti que des interférences ne se produiront pas dans certaines installations. Si cet équipement cause des interférences à la réception radio ou télévisée (ce qui peut être vérifié en éteignant l'appareil puis en le remettant sous tension), l'utilisateur peut tenter de les résoudre en suivant une ou plusieurs des mesures ci-après : Réorienter ou déplacer l'antenne réceptrice. Augmenter l'espace entre l'appareil et le récepteur. Brancher l'appareil à une prise de courant différente de celle sur laquelle le récepteur est branché.</p> <p>Pour obtenir de l'aide, contacter le vendeur ou un technicien radio/télévision expérimenté.</p> <p>REMARQUE : Toute modification non autorisée expressément par le fabricant responsable de la conformité peut annuler le droit de l'utilisateur à faire fonctionner le produit.</p>

This Class B digital apparatus complies with Canadian ICES-003.

This device complies with Industry Canada license-exempt RSS standard(s). Operation is subject to the following two conditions: (1) this device may not cause interference, and (2) this device must accept any interference, including interference that may cause undesired operation of the device.

Le présent appareil est conforme aux CNR d'Industrie Canada applicables aux appareils radio exempts de licence. L'exploitation est autorisée aux deux conditions suivantes : (1) l'appareil ne doit pas produire de brouillage, et (2) l'utilisateur de l'appareil doit accepter tout brouillage radioélectrique subi, même si le brouillage est susceptible d'en compromettre le fonctionnement.

**Applicable only to V4GSCW which has WLAN:**

This product complies with FCC radiation exposure limits set forth for an uncontrolled environment. To comply with FCC RF exposure requirements, it must be installed and operated in accordance with provided instructions. The unit requires minimum 20cm (8inch) spacing between the unit and all persons' body (excluding hands and feet) during wireless modes of operation. This equipment complies with IC radiation exposure limits set forth for an uncontrolled environment.

Cet équipement est conforme aux limites d'exposition aux rayonnements définies par IC pour un environnement non contrôlé. Cet équipement doit être installé et utilisé avec un minimum de 20 cm.



Under Industry Canada regulations, this radio transmitter may only operate using an antenna of a type and maximum (or lesser) gain approved for the transmitter by Industry Canada. To reduce potential radio interference to other users, the antenna type and its gain should be so chosen that the equivalent isotropically radiated power (e.i.r.p.) is not more than that necessary for successful communication.

Conformément à la réglementation d'Industrie Canada, le présent émetteur radio peut fonctionner avec une antenne d'un type et d'un gain maximal (ou inférieur) approuvé pour l'émetteur par Industrie Canada. Dans le but de réduire les risques de brouillage radioélectrique à l'intention des autres utilisateurs, il faut choisir le type d'antenne et son gain de sorte que la puissance isotrope rayonnée équivalente (p.i.r.e.) ne dépasse pas l'intensité nécessaire à l'établissement d'une communication satisfaisante.

This radio transmitter 4GSCW has been approved by Industry Canada to operate with the antenna types listed below with the maximum permissible gain and required antenna impedance for each antenna type indicated. Antenna types not included in this list, having a gain greater than the maximum gain indicated for that type, are strictly prohibited for use with this device.


Le présent émetteur radio 4GSCW a été approuvé par Industrie Canada pour fonctionner avec les types d'antenne énumérés ci-dessous et ayant un gain admissible maximal et l'impédance requise pour chaque type d'antenne. Les types d'antenne non inclus dans cette liste, ou dont le gain est supérieur au gain maximal indiqué, sont strictement interdits pour l'exploitation de l'émetteur.

Antenna: S151AH-2450S, NEARSON INC.

## 9.2 CE Information to Users

All 4G Lite devices and 4G Secure Control have the CE mark, for compliance with CISPR22/EN55022 requirements. For European Union (EU) countries, 4G Lite devices and 4G Secure Control are compliant with CE under the R&TTE Directive, related to the radio transceivers that are part of their design.

## 9.3 Warning to Users

	<p style="text-align: center;"><b>CAUTION</b></p> <p>Changes or modifications not expressly approved by L-1 Identity Solutions Inc. could void the user's authority to operate the equipment.</p>
---	---

# GLOSSARY

**1:1 Mode** - In 1:1 mode, a user enters his or her User ID first. Then the user is requested to place a fin-ger or enter a PIN. In 1:1 Mode, the user's scanned fingerprint is matched against the one specified by the user ID.

**1:N Mode** - In 1:N mode, a user places his or her finger on the device without entering an ID. The device compares the user's scanned fingerprint with the many enrolled fingerprints in its internal database. Admin/Administrator - A user who is authorized to manage the settings and user information of a fin-gerprint reader. Administrators can enroll or delete users and change device settings.

**Core** - a term used to describe an area of the finger-scan characterized by ridgelines with the tightest curvature and most unique content. Although the entire finger-scan has significant data, the "core" is the most data-intensive area and thus is extremely important to the algorithm. Normally, the core is located in the middle of the fingerprint.

**Duress Mode** - A mode that offers users a way of indicating a duress situation (such as being forced to open a door). The user verifies with a specially designated finger resulting in an inverted Wiegand output that is detectable on certain Access Control Panels.

**Enrollment** - The process of extracting features of a fingerprint image obtained from a fingerprint sensor and saving them into the internal memory of a device. The fingerprint data is called a fingerprint tem-plate.

**Finger Placement Feedback (FPF)** - FPF is a feature that allows an administrator to direct users in cor-rect finger placement during enrollment and helps users learn correct placement. The FPF feature helps an administrator to know when an enrolling user has positioned their fingerprint core optimally on the scanning surface. Without this feature, the administrator has to try to recognize the core visually and then make a judgment call as to whether the placement was optimal. The FPF also allows the fingerprint image to remain hidden to add to personal biometric privacy.

**Finger Scan** - the image of a fingerprint that is captured by the sensor.

**Firmware** - The set of programs contained permanently in a hardware device (as read-only memory) that controls the unit.

**Fish** - The process of threading cables or wires between points on a wall.

**Host Mode** - the normal mode of operation; when the unit is waiting for a card to be presented to the device.

**Identification (Searching or 1:N)** - the operation of Identifying a user by comparing a live finger scan against all stored finger-scan records in a database to determine a match. Identification uses the finger scan only -- no cards or PINs. Identification is only available on devices that are in 1:N mode.

**Optical Sensor** - A device that detects that detects the intensity or brightness of light. Secugen sensors are used to create graphical representations of fingerprints.

**Ridgeloock** - Used to center the user's finger core for optimal scanning.

**SecureAdmin Lite** - Client software for managing device configuration.

**SecureAdmin Lite Server** - Centralized software repository containing the database for all devices in a net-work to reference.

**Single Door Access Control** - The capability of controlling/monitoring all functions related to a single entry/exit point.

**Software** - The set of programs associated with a computer system.

**Template** - a term used to describe the data that is stored during the enrollment process. The data is a mathematical representation of the ridge pattern of the enrolled finger scan.

**Users** - The individuals that use a hardware system.

**User Groups** - The sets of users grouped together in a system (usually by the similarity of the functions they perform).

**Verification (Authentication or 1:1)** - the operation of confirming a user is who he claims to be by com-paring a live finger scan image against a stored fingerprint template. The result (pass or fail) that is re-turned is based on whether the score is above a pre-defined threshold value. Some type of credential (PIN, prox card, smart card, etc.) is necessary to initiate the biometric verification.

## Acronyms and Abbreviations

These acronyms and abbreviations are used in this document:

- AUX** Auxiliary
- FPF** Finger Placement Feedback
- TFT** Thin Film Transistor
- LED** Light Emitting Diode