

FCC Information to Users @ FCC 15.21 & 15.105

For Class B Unintentional Radiators:

This equipment has been tested and found to comply with the limits for a Class B digital devices, pursuant to Part 15 of the FCC Rules. These limits are designed to provide reasonable protection against harmful interference in a residential installation. This equipment generates, uses, and can radiate radio frequency energy and, if not installed and used in accordance with the instruction manual, may cause harmful interference to radio communications. However, there is no guarantee that interference will not occur in a particular installation. If this equipment does cause harmful interference to radio or television reception, which can be determined by turning the equipment off and on, the user is encouraged to try to correct the interference by one of more of the following measures:

- *Reorient or relocate the receiving antenna*
- *Increase the separation between the equipment and receiver*
- *Connect the equipment into an outlet on a circuit different from that to which the receiver is connected.*
- *Consult the dealer or an experienced radio/TV technician for help.*

Warning: Changes or modifications not expressly approved by BIOSCRYPT INC. could void the user's authority to operate the equipment

Checklist For Unpacking



Veri-Series reader
(V-Smart and V-Station differ from picture shown)

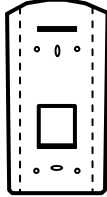

Wall mounting plate /
Mullion mounting plate
(V-Smart and V-Station differ from picture shown)



Tools
1/8" security hex key



Pigtail cable
(not included for V-Station)



Documentation
Veri-Series Setup
Guide

Hardware
(4) #6-32 screws
(4) #6 self-tapping screws
(4) #4-8 wall anchors
(14) crimps
(1) plastic Aux port door
(2) #4-40 screws

Documentation provided with your new fingerprint reader is installed onto your computer when you install the VeriAdmin software (also available online at <http://www.bioscrypt.com>). To view the documentation you can use Windows Explorer (available from the Start Menu under Programs) to navigate to C:\Program Files\Bioscrypt\VeriAdmin\Docs or another location that you defined during the installation procedure. The documentation is provided in Adobe® Acrobat® format (PDF). The Adobe Acrobat reader is available on the CD or on-line at www.adobe.com.

Other required equipment



PC (optional for V-Station)
 One available COM port
 (or Ethernet card)
 Windows 98, ME, NT4,
 2000, or XP
 486-compatible
 16 MB RAM
 30 MB disk space



Power supply



Door controller

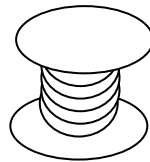

Networking cable

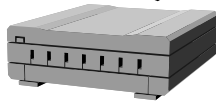

RS-232/RS-485 Converter



P/S for converter



CD with VeriAdmin
 software and
 documentation

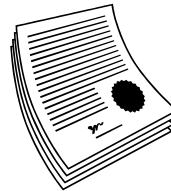

User
 Documentation
 (included on
 VeriAdmin CD)

Introduction

The Veri-Series Setup Guide provides you with general information on installing your fingerprint reader and using the reader and associated software. This document is not a substitute for the more comprehensive documentation provided with your reader and available on the CD-ROM or installed on your computer with the VeriAdmin software. Please refer to the [Veri-Series Installation Guide](#) and the [Veri-Series Operations Manual](#) for additional information. If there are any questions about information in this guide or in the more comprehensive documentation please contact Bioscrypt Technical Support using the contact information located in the Warranty and Returns section of this document.

Please see the Release Announcement document on the CD-ROM for the latest updates to this and other documentation.

Learning More About Your New Fingerprint Reader



Internally, your fingerprint reader is powered by hardware and software developed by Bioscrypt. The "bioscrypt on board™" logo signifies that Bioscrypt's biometric technology has been integrated into this product. It provides the assurance that Bioscrypt's high standards of biometric quality and security reside within the product.

The V-Smart™ Fingerprint Reader



The V-Station™ Fingerprint Reader



The Veri-Series Product Line

The Veri-Series fingerprint readers are used in access control and other related fields. There are a variety of features common to the various products, but there are differences as well, as described below. For more on the operational differences between the products please see Basic Operation on page 30.

Common Features

The various products in the Veri-Series line have some features in common such as both RS-232 and RS-485 serial communications protocol support for connection to a PC, Wiegand input and output protocol support for connection to access control equipment, a wide power input range (9-24 Volts DC) except for the V-Smart (9-12 Volts DC) and V-Station (12.5-24 Volts DC), and a requirement for earth ground connection to dissipate static electricity (ESD).

Product Specific Differences

V-Prox™: The V-Prox has a built-in HID proximity card reader that negates the need for external Wiegand input, and provides one-to-one fingerprint authentication. The V-Prox is capable of storing up to 4000 fingerprint templates (a "template" is a mathematical model of the fingerprint that is generated during enrollment). The device can be mounted on door Mullion or single-gang electrical box.

V-Flex™: The V-Flex has all the capabilities and features of the V-Prox described above except that there is no built-in HID proximity card reader. Therefore the V-Flex requires an external Wiegand input signal. The V-Flex is designed for

retrofit applications and for applications where a card technology other than HID is desired.

V-Pass™: The V-Pass provides one-to-many fingerprint identification for small user populations (the system is optimized for user populations up to 100, but can be used for populations up to 200). The V-Pass provides fingerprint only identification – no cards or PINs are required to use the system. The V-Pass is also small enough to be mounted on a door mullion or a single-gang electrical box.

V-Smart™: The V-Smart supports one-to-one fingerprint authentication by means of an industry standard MIFARE®-compatible or *iCLASS™* contactless smart card reader. The fingerprint template is stored on the smart card, not on the reader, so the user population is unlimited – simply issue a smart card to each employee.













V-Station™: The newest addition to the Veri-Series product line, the V-Station contains a backlit LCD display and keypad, enabling template management and unit configuration directly from the unit; a PC is not required. Variations of this product are offered with an HID proximity card reader, a Smartcard reader (MIFARE or *iCLASS*), or as a searching unit. Also, this is the first product to offer Ethernet support. It is probably the most versatile product in the Veri-Series.

MIFARE® is a registered trademark of Philips Semiconductors

iCLASS™ is a trademark of HID Corporation

Required Connections

The following table shows required and optional connections to the various products.

Product	Power Input	Wiegand Input	Wiegand Output	Serial Comm.	Earth Ground
V-Prox			***	**	
V-Flex			***	**	
V-Pass			***		
V-Smart	 *		***		
V-Station	 *		***	**	

* The power input on V-Smart is 9-12 VDC and 12.5-24VDC on V-Station instead of 9-24 VDC on the other products.

** RS-485 communication is typically used for template distribution to multiple units.

*** Wiegand output is typically used to send the user information (ID number and facility code from card) to an access control panel, but this connection is not strictly required.

Preparing Wiring

1. Wiring connections to be made:
 - Wiegand – should be 18-22 AWG (10-7 MWG) wire, between 3 and 6 conductors depending on which signals will be carried, shielded cable is recommended, and typically the conductors are made of stranded wire. Minimum connections: Data0, Data1, Wiegand Ground
 - RS-485 – use category 5 shielded cable.
 - Ethernet – use category 5 shielded cable
 - Power – should be 18 – 22 AWG (10 – 7 MWG) wire, 2 conductors.
 - Earth Ground – use a single wire with heaviest gauge reasonable.

Warning: Do not use Power Ground as a substitute for Earth Ground.

2. Pigtail Connections (V-Prox, V-Flex, V-Pass, V-Smart):

Pin #	Signal Description	Original Cable	New Cable
	Jacket	Gray	Blue
1	Wiegand Out Data 0	Red w/ Black	Green
2	Wiegand In Data 0	Green w/ Black	Green/White
3	Wiegand Out Data 1	Org	White
4	Wiegand In Data 1	Org w/ Black	White/Black
5	Line Trigger	Green	Gray
6	Wiegand GND	Red	Black/White
7	RS-485 (-)	Blue w/ Black	Blue/Black
8	RS-485 (+)	White	Blue
9	RS-232 Tx	Black w/ White	Violet
10	RS-232 Rx	Red w/ White	Violet/White
11	Power GND	Black	Black
12	Signal GND	Green w/ White	Black/Red
13	Power input (9-24 VDC) <i>*(9-12 VDC) for V-Smart</i>	Blue w/ White	Red
14	Reserved	Blue	Red/White
15	Earth ground	White w/ Black	Green/Yellow

3. Weidmuller Connections (V-Station only):

Group	Label	Signal Description
RS-485	TX(+)	Transmit +
	TX(-)	Transmit -
	RX(+)	Receive +
	RX(-)	Receive -
	GND	RS-485 Ground
RS-232	GND	RS-232 Ground
	TX	Transmit
	RX	Receive
Power/Ground	+(POS)	12.5 - 24 VDC +
	-(NEG)	12.5 - 24 VDC -
	EGND	Earth Ground
Wiegand	IN 0	Data 0 In
	IN 1	Data 1 In
	OUT 0	Data 0 Out
	OUT 1	Data 1 In
	LED IN	LED In
	LED OUT	LED Out
	GND	Wiegand Ground
TTL (IN)	IN 0	TTL Data 0 In
	IN 1	TTL Data 1 In
TTL (OUT)	OUT 0 H	TTL Data 0 Out
	OUT 1 L	TTL Data 1 Out
	GND	TTL Ground

4. [RS-485 network only]: Use a daisy chain network design as depicted in the following figure. Do not use a star or other multi-drop configuration.

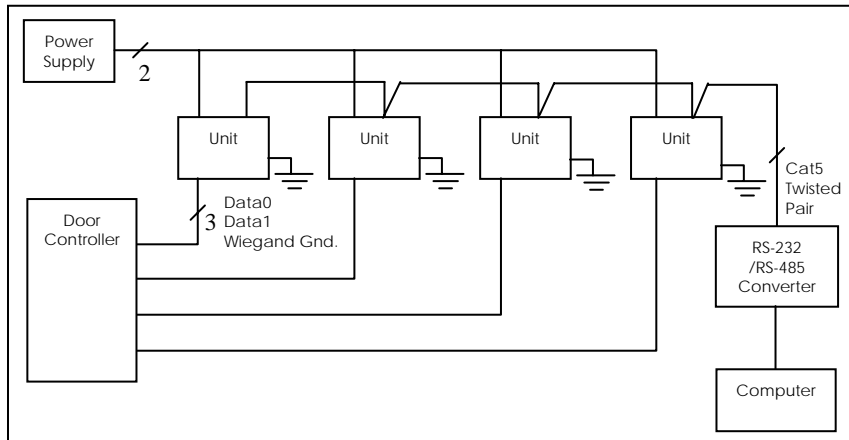

Use one pair (e.g. blue/white and white/blue) for RS-485 connections. Connect readers identically at each reader (e.g. blue/white on Cat5 to RS-485 (-) on pigtail/Weidmuller Connector and white/blue on Cat5 to RS-485 (+) on pigtail/Weidmuller Connector).

- [RS-485 network only]: At converter, jumper TD(A) with RD(A) and TD(B) with RD(B). Connect Blue/white from Cat5 to either of A terminals and White/blue from Cat5 to either of B terminals. Make certain to connect power correctly.

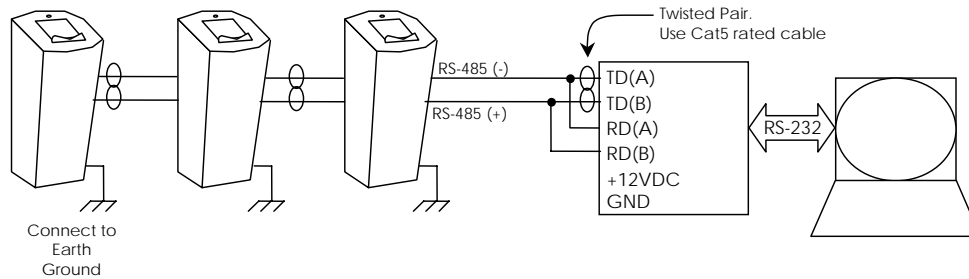

- [RS-485 network only]: RS-485 supports distances up to 4,000 feet (1,200 meters) and/or 31 readers. To extend these limitations, contact Bioscrypt Technical Support. Typically no end-of-line termination is required unless the total run exceeds 2,000 feet.

7. [RS-485 network only]: Set up network using 9600 baud rate. Only increase this data rate after the system is operating properly at 9600.
8. [Ethernet network only]: Typically a star network topology is used with a network switch or hub, but a bus topology may be used. Be sure to connect all devices using straight-thru (as apposed to cross-over) cables. The exception to this is when connecting a single device directly to the computer Ethernet adaptor.
9. [Ethernet network only]: Up to 254 readers can reside on a single Ethernet bus, although repeaters may be required to boost the signal over longer distances. The V-Station supports 10base-T Ethernet (10 Mbps)*. A 10 Mbps Ethernet network supports distances up to 100 meters (328 ft.) between readers (2,500m with repeaters). Bioscrypt recommends isolating your network of readers from computers (other than the admin PC) and other devices to maximize security. A firewall is highly recommended if the network will include other devices or PCs. For obvious reasons, it is not a good idea to expose your network of readers to the outside world (i.e., the Internet).

*Ethernet communication is supported in firmware versions 7.10 and higher. VeriAdmin 5.10 or higher is required for administration over Ethernet.

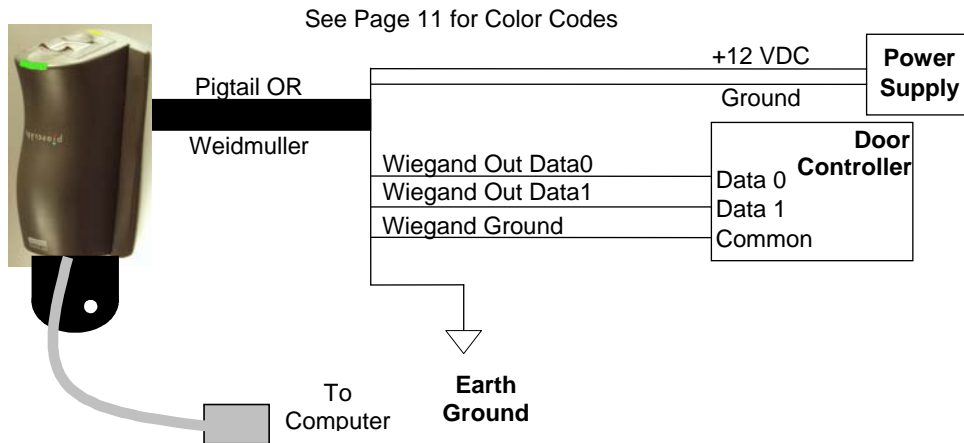

Configuring Readers

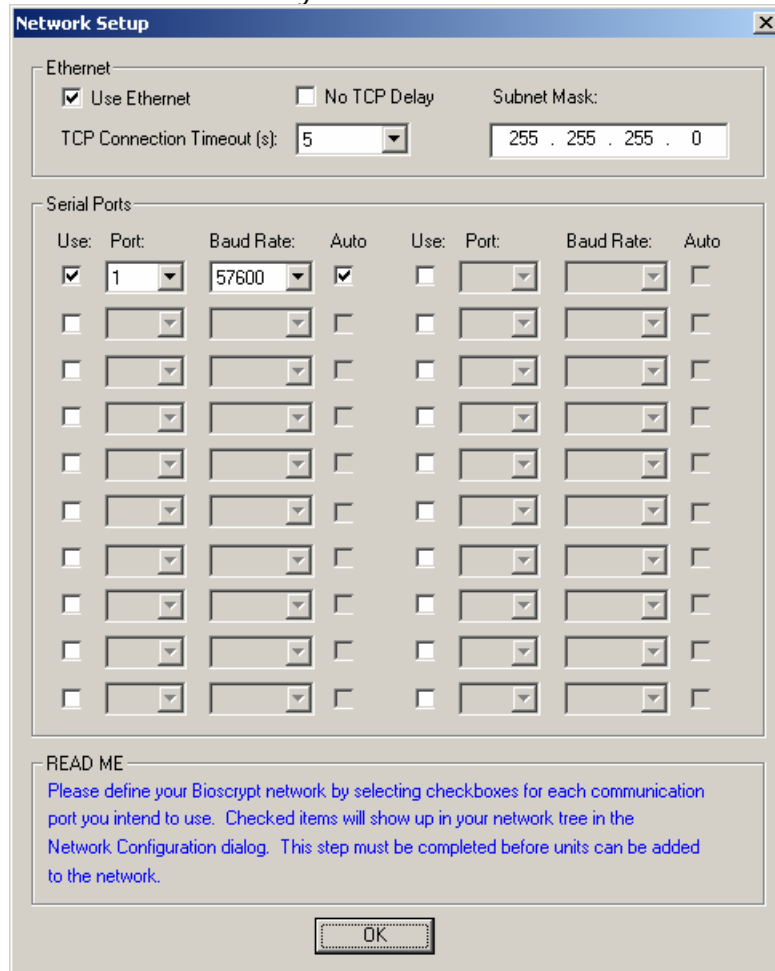

1. Set up a configuration station
 - a. Wire the unit for power:
 - V-Prox/V-Flex/V-Pass: Connect the RED pigtail wire to 9-24V DC power and the BLACK wire to power ground.
 - V-Smart: Connect the RED pigtail wire to 9-12V DC power and the BLACK wire to power ground.
 - V-Station: Connect 12.5-24V power in to the +(POS) Weidmuller connector and the power ground to the -(NEG) connector.
 - b. Optionally wire up Wiegand output to a door controller.
 - c. Have a computer running VeriAdmin software available.
 - d. Have RJ11 communications cable available.
2. Connect the reader for communication
 - a. Connect RJ11 to reader and DB9 to PC COM port.
 - b. Plug pigtail cable into reader (if not a V-Station) and connect power to appropriate conductors identified in the charts on pages 11 and 12.

3. Configure the device using the VeriAdmin software provided
 - a. If running VeriAdmin for the first time, you will be directed to the Network Setup dialog. This dialog is also reached by clicking on this icon: . Select the serial (COM) port(s) you intend to use or Ethernet and click OK. It is recommended that you check "Auto".



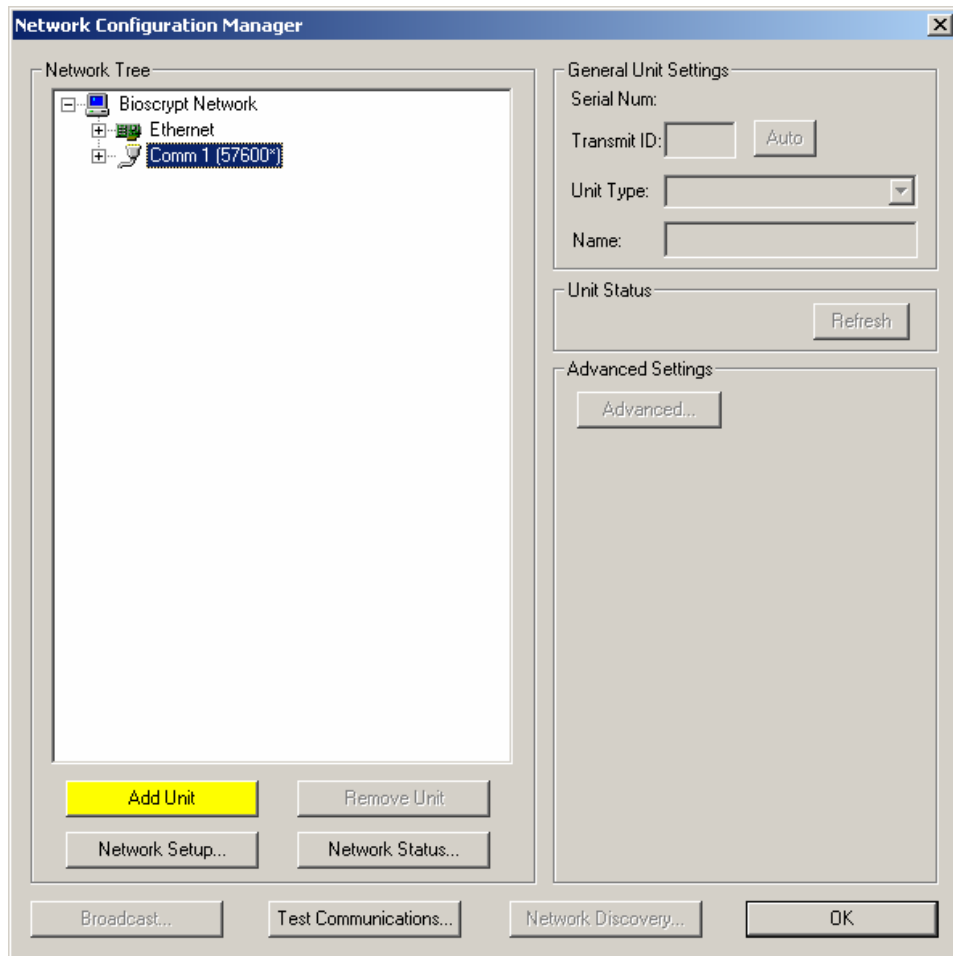

- b. This will bring you to the Network Configuration Manager dialog. First click on the Comm port or Ethernet within the network tree which you have connected the unit to (the  or  icon). Then click on the “Add Unit” button (lower left).

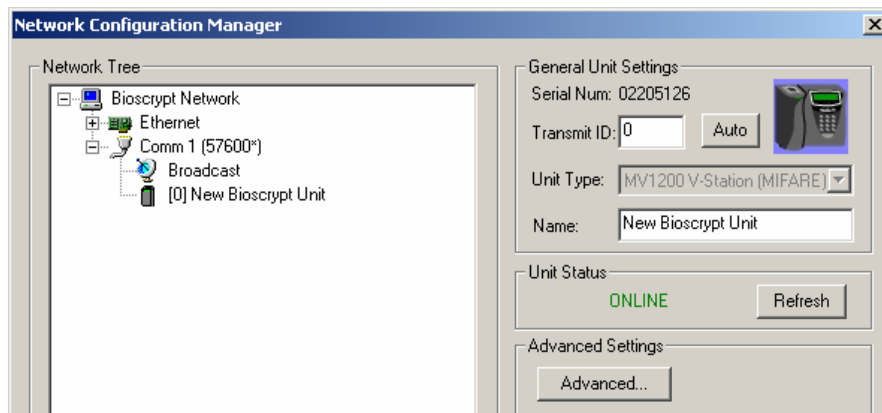

- c. VeriAdmin should establish communication with the unit. The Unit Status field should indicate **ONLINE**, you may hear the unit beep, and other fields on the right side should populate. If you are connecting via Ethernet, you must first assign the unit an IP address from the unit's keypad and then type in the address under Ethernet Settings and click the Refresh button.
- d. If VeriAdmin shows **NOT RESPONDING**, check the connections and then press the Refresh button to try again.
- e. You may assign the unit a name (default is "New Bioscrypt Unit") if desired.



- f. The network tree shown on the left will show a small icon representing the current unit , just below the  icon under the port you selected. Double-click on this icon to open the Unit Parameters dialog.

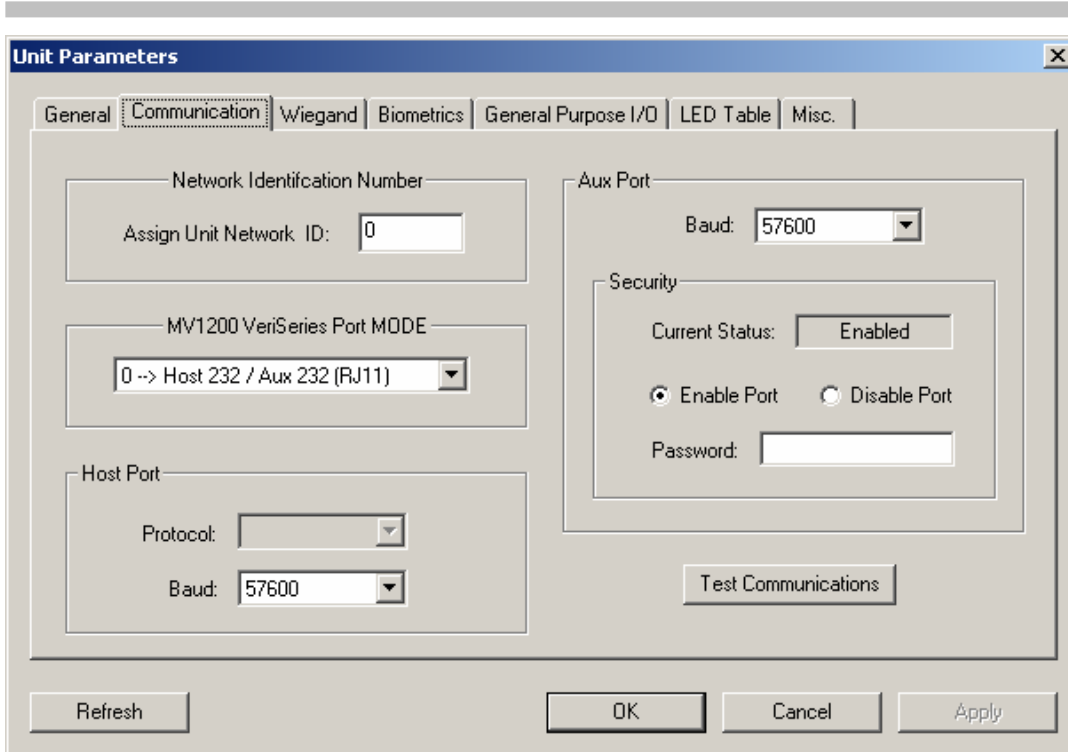

- g. Change desired parameters. Typical changes are:
- i. *Communication Tab*: Network ID (default is 0, but each unit must have a unique ID number such as 1, 2, 3, 4, etc.)
 - ii. *Wiegand Tab*: Wiegand parameters

NOTE: We do not recommend changing the Aux. port Baud rate at this time.

4. Repeat steps 2-4 (skipping 3a) for the next reader until all readers are configured.

5. If placing units on a RS-485 network, you will also need to set up the computer for RS-485 communications.
 - a. Connect the RS-232/RS-485 converter to the PC's COM port (must support Send Data – a means of automatically sensing data sent from the RS-232 port – we suggest the B&B Electronics, www.bb-elec.com, model 485TBLED or equivalent).
 - b. Run category 5 rated cable from the converter to the first reader in the daisy chain.

6. V-Smart considerations
 - a. The V-Smart does not require an RS-485 network. There is no need to distribute templates because the templates are carried by the users in the cards.
 - b. One security aspect of the V-Smart is that a site key is used to secure the information on the smart card. If a card is presented to the V-Smart it uses the programmed site key to unlock the data from the card. The V-Smart is shipped with a default site key (a blank field). If the programmed site key does not unlock the data from the card, the user cannot verify their fingerprint. This provides system administrators with a means to further protect their facilities from unauthorized access.
 - c. If the system administrator wants to periodically change the site key (to further minimize the risk of compromised or lost cards), then this can be done through an RS-485 network or by making the appropriate changes to the reader through the Aux port.

7. V-Station considerations
 - a. The V-Station does not require configuration via a PC. Nearly all configuration options can be set using the menus on the unit. However, it may be more convenient to administer the device from the PC due to the limited size of the LCD screen.
 - b. To distribute templates to other V-Stations, you will need to place all V-Stations on a network and administer them via the PC. Alternatively, templates can be stored on the PC and transferred to each V-Station separately, via the Host, Aux, or Ethernet ports.
 - c. To access some advanced features such as the transaction log, you will need to communicate with the V-Station from the PC.
 - d. Connecting to a V-Station via Ethernet should be done by a network administrator or one familiar with TCP/IP operations. The V-Station should be assigned an appropriate IP address or be set to use DHCP*. Caution should be exercised when manually assigning IP addresses: it should be appropriate for the given network and should not conflict with other devices or PCs on the network. Bioscrypt recommends isolating all V-Stations on a closed Ethernet network, both for security reasons and to avoid conflicts with other computers and devices on the network.

* DHCP may not be available in some firmware versions.

Mounting Readers On The Wall

1. The readers come disassembled, however, if your reader has previously been assembled then disassemble the reader body and smart card module (for V-Smart only) from the wall plate.
 - a. On V-Smart remove security screw securing smart card module
 - b. For products other than V-Station, remove security screw securing the Aux. port cover, and remove the Aux. port cover by twisting (see graphics on page 25).
 - c. Remove #4-40 screw securing reader body to wall plate.
 - d. Remove smart card module (on V-Smart only) and reader body by sliding up and pulling away from the wall plate.
 - e. Keep screws and Aux. port cover for re-assembling the device.
2. Define a location. A good location will have these qualities:
 - a. Comfortable height for finger placement

NOTE: If readers need to be mounted above 54" or below 48", please contact Bioscrypt for available accessories to properly readjust the angle of the reader for optimal finger placement. Mounting a reader above or below the recommended height will not be ergonomic for the user and will not promote good finger placement on the sensor.

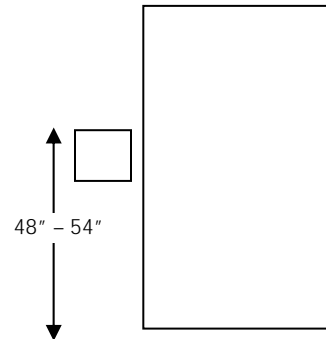

- b. ADA considerations

- c. Provide clearance above and below for access
 - d. The access hole in the wall for wiring should be less than 1 ½ inches wide so that wall plate will cover it. It should be less than 1 ½ inches tall if mounting into dry wall so that there is enough material to hold the anchor. The recommended size is 1 inch wide by 1 1/8 inches tall to match the opening in the wall plate.
 - e. For V-Smart, the access hole in the wall for wiring should be less than 4 ½ inches wide so that wall plate will cover it. It should be less than 2 ½ inches tall if mounting into dry wall so that there is enough material to hold the anchor. The recommended size is 3 ½ inches wide by 2 ½ inches tall.
 - f. For V-Station, the rear of the unit will protrude past the wall plate and into the wall approximately 1 inch (depending on the Weidmuller connectors attached). The access hole must be exactly the size of the hole in the wall plate (136mm (~5 3/8") wide by 69mm (~2 ¾") tall). It may be helpful to trace the edges of the hole in the wall plate in pencil before cutting.
 - g. **Please see pages 26 – 28 for templates for the single-gang and double-gang mounting plates.** These templates are dimensioned in millimeters (mm).
3. Make pigtail (or Weidmuller for V-Station) wiring connections to power, Wiegand or other connections prior to mounting wall plate.
 4. For the V-Smart, feed pigtail cable from Smart Card Module through hole in wall plate from the front and connect to pigtail cable already wired in wall cutout.
 5. For the V-Smart, connect Smart Card Module to wall plate. Line up four tabs, push forward and then down. Secure smart card module with the security screw at the bottom.

6. Feed main pigtail DB15 connector (not applicable to V-Station) through wall plate from the back and proceed to mount wall plate:
 - a. Optionally mount to a gang box using #6-32 screws provided.
 - b. Optionally mount on wall.
 - i. Use 4 outer mounting points (6 for V-Station).
 - ii. Up to #6 screws can be accepted (screws and drywall anchors are provided).
 - c. Use template provided to mark holes.
7. Attach pigtail to the reader body (not applicable to V-Station) and attach body to wall plate using same motion as for the smart card module. Secure the body to the wall plate with the #4-40 screw at the bottom. Replace the Aux. port cover (see next page).

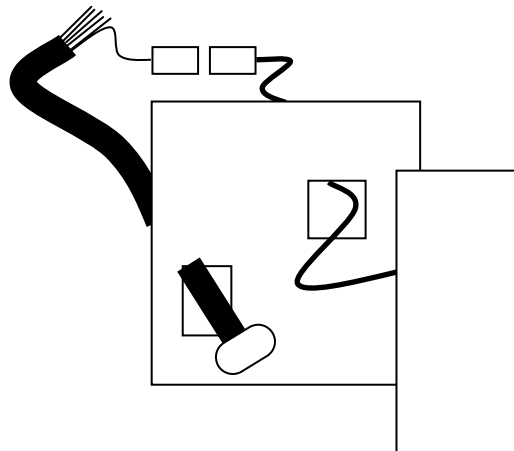

8. The RJ11 security cover is removed to install the reader body to the wall mount. Once the screw is in place, the security cover can be snapped into place using the following procedure:

With the textured side facing down,

- 1) place left tab into left corner groove on reader body
- 2) rotate cover until right tab easily slides into groove

- 3) with tab in the reader body groove, rotate the cover clockwise until the right tab snaps into place at the right rear corner



Step 1



Step 2



Step 3

- 4) Finally, fold the cover up and secure it using the supplied security screw and special Allen wrench.

The following pages show the dimensions of the wall mounting plates for the smaller Veri-Series readers (V-Prox, V-Flex, V-Pass), the V-Smart, and the V-Station. The diagrams are not to scale however full-scale drawings can be found in the *Veri-Series Installation Guide*.

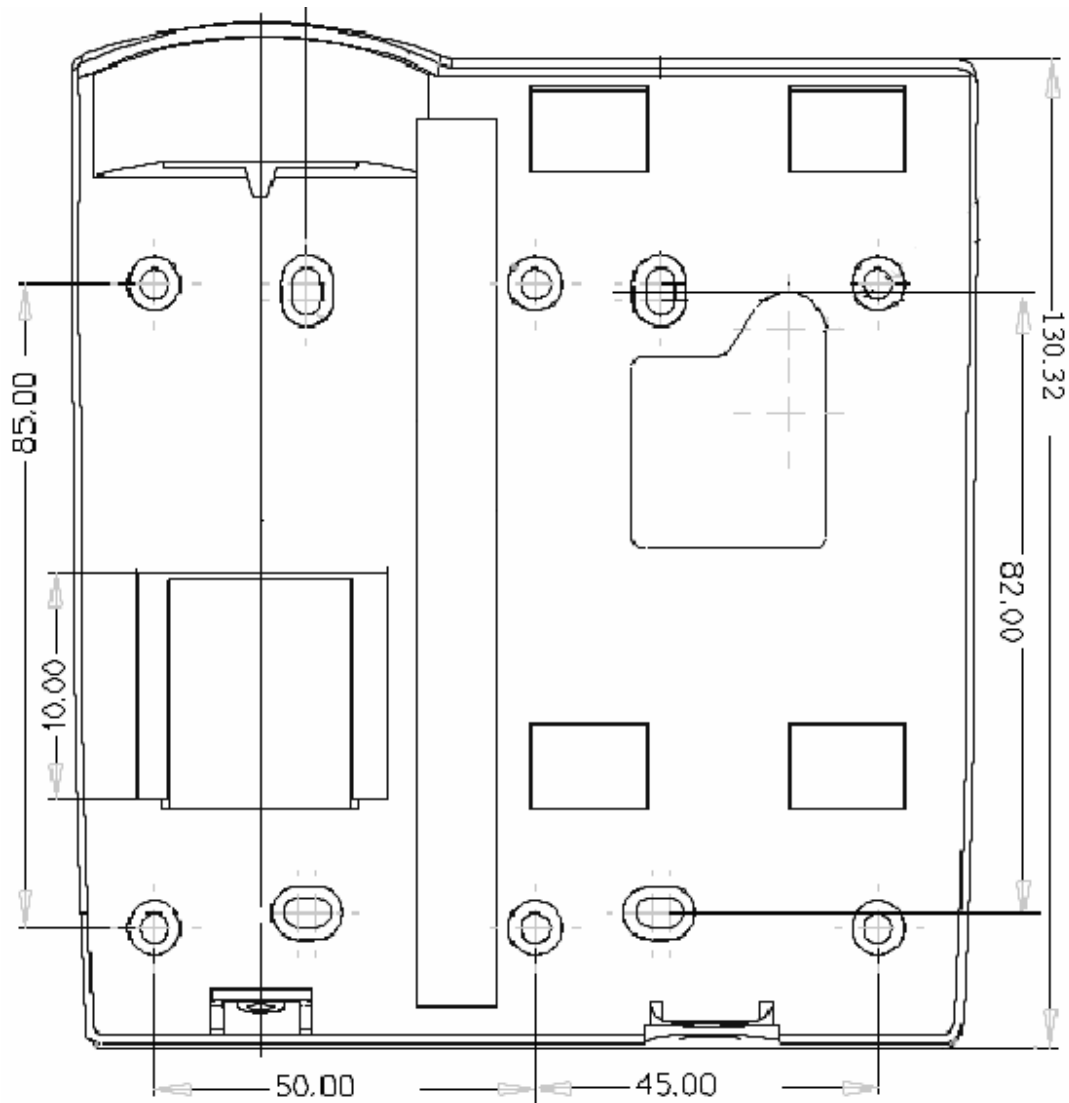

Mounting Template for V-Smart (MIFARE and iCLASS) (not to scale)

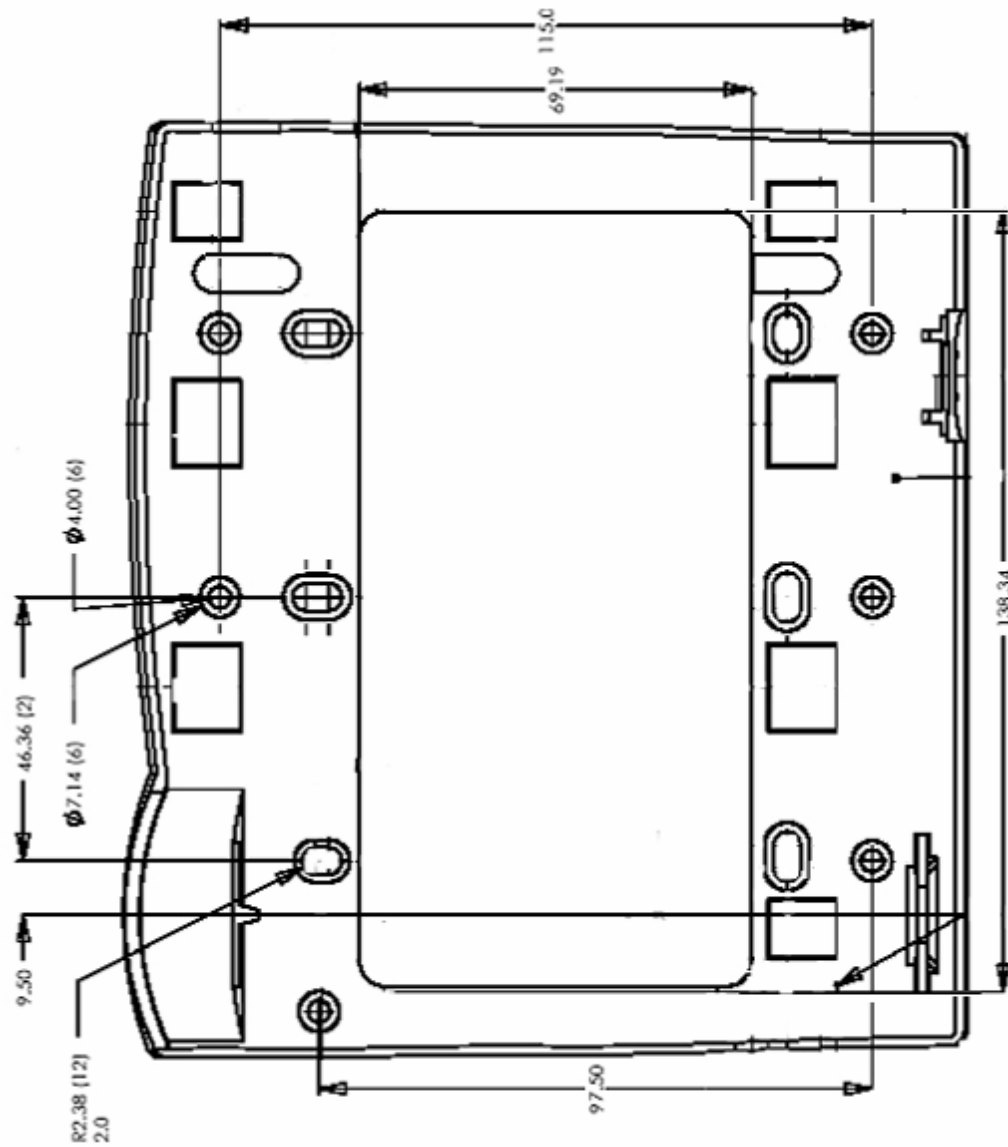

Mounting template for V-Station (all models) (not to scale)

Basic Operation

1. Use VeriAdmin software to enroll a new fingerprint:

Enrollment is the process of generating data that the reader will store and use to later verify your identity.

- a. Make sure that the correct unit is identified on the main toolbar dropdown.
- b. Go to the Template Manager screen.
- c. Click on Quick Enroll.
- d. Enter an ID number. This can be the number of the user card (prox, bar code, magnetic stripe, or other technology) or some other number such as when using the V-Pass or V-Smart.
- e. Click on the Enroll button – User must place their finger on the sensor when the light turns amber and leave their finger on sensor until the light goes out. Use the RidgeLock during enrollment to obtain a finger placement consistent with what would be expected during Verification. The ridge should comfortably fit in the first crease of the finger. Do not use thumbs for enrollment or verification.
- f. The enrollment will be scored in terms of Content and Quality on a scale of 0-5 stars. Bioscrypt recommends a minimum





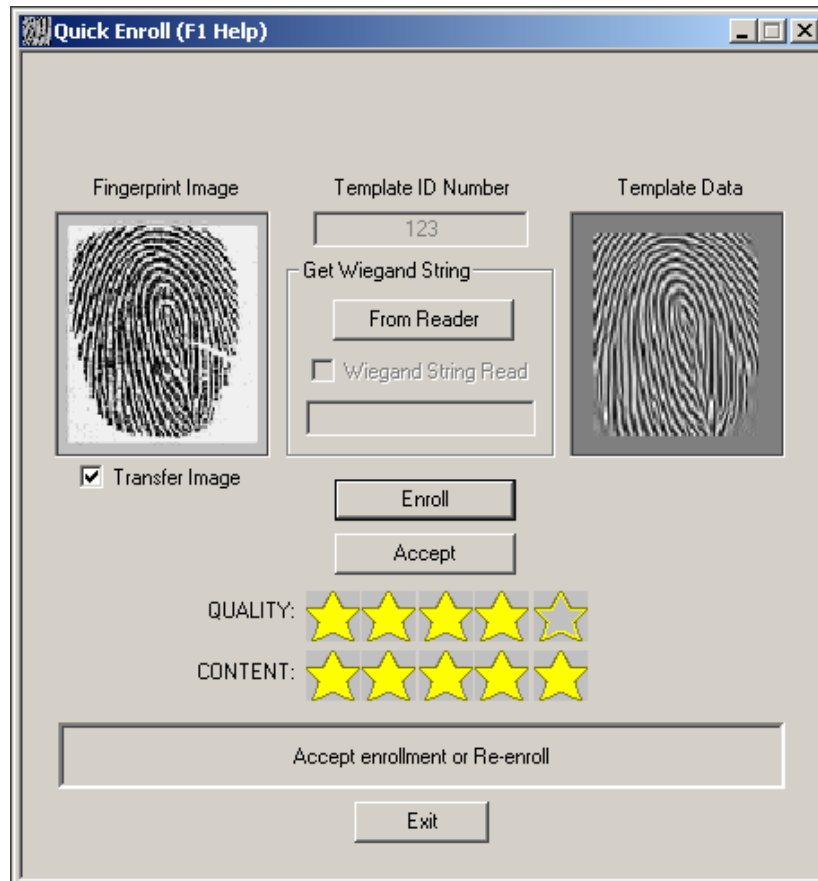

Quality is a measure of how clearly the fingerprint is shown in the image.



Content measures how unique (i.e., curvy) the captured pattern is.

score of 3 stars for quality and 2 stars for content. If enrollment scores for Content and Quality are acceptable, then click on Accept.



- g. Fill in desired information and decide where the template will be stored (either on PC, the unit used to enroll, or a smart card). Click on the appropriate "Save" button.

- h. If templates are saved to the PC or the unit and are to be distributed to other readers, then this can be done using the Template Manager functions. In the case of V-Smart, the template is stored on the smart card and does not need to be distributed.
2. Using the keypad to enroll a new fingerprint (V-Station only):
 - a. From the idle screen (showing "Bioscrypt" with the date and time), press **0-0-0** (three zeroes) and . You will be warned about no admin ID.
 - b. You are now in the V-Station menu system. From here you may traverse the menus using the  and  buttons, the  button to enter a menu, and the  button to back out to the previous menu.
 - c. Enter the Template Admin menu, then the Enroll (Add) User menu. Enter an enroll ID between 1 and 4294967294.
 - d. Place your finger on the sensor when the amber LED turns on, making sure to use the RidgeLock.
 - e. After retrieving the live fingerprint, you will be shown the content and quality in stars (asterisks) (5 is the best). Bioscrypt recommends at least 3 stars for quality and 2 for content. To accept the enrollment, press **1**. To reject it, press **2**. To re-try enrollment, press **3**.
 - f. Choose the finger enrolled, 0 - 9 (**0** = left pinky, **9** = right pinky). You may press  if you don't want to specify a finger.
 - g. Choose whether the finger should be a Duress finger or not (**0** = No, **1** = Yes, or simply  for No).

- h. Choose the security level, 0 – 6 (**0** = none, **1** = very high, **2** = high, ... **5** = very low, **6** = Password Only). You may press  for the default (3).
- i. Choose the admin level 0 – 2 (**0** = user, **1** = enroller, **2** = full admin). You may press  for the default (user).
- j. Enter a password for the template, if desired, or  for none.
- k. If the unit is a V-Station MIFARE or V-Station iCLASS, the next menu will ask if you would like to save the template to the unit (**1**) or to a smart card (**2**). If saving to a smart card, you will need to enter the current site key (it must be numeric, and is set using VeriAdmin) and then present an appropriate fresh or blank smart card.
- l. Finally, you may elect to enroll an alternate finger with the same ID. Press **1** for yes or **2** for no

3. Verification is as simple as:

Verification is the process of comparing a live fingerprint scan to the fingerprint data stored during enrollment.

- a. Present the card to reader (unless using a V-Pass in which case, skip to b) or enter your ID number at the keypad if using a V-Station (when in idle mode).
- b. When the light turns yellow place the finger on sensor in same position as when it was enrolled and hold. Use the RidgeLock to position your fingerprint on the sensor. This will help to generate consistent finger placement. The ridge should fit comfortably in the first crease of your finger.

- c. When the light turns off, remove the finger and the door lock will release if the verification was successful (reader will indicate green for success or red for failure).

4. Cleaning and care of the sensor

The fingerprint sensor is a solid-state device designed to provide years of trouble-free service. Although there is little to do in terms of maintenance, a few basics in caring for the sensor will help to ensure a high level of performance over the life of the sensor.

Oily deposits from your finger accumulate on the surface of the fingerprint sensor after repeated use. These deposits can degrade the performance of the system. Cleaning can be done regularly but is only required when a significant amount of residue builds up on the sensor.

To clean the sensor, use a clean, soft cloth dipped in isopropyl (rubbing) alcohol. Use a sweeping motion to remove deposits from the sensor. Do not use a soiled cloth or any abrasive brushes, pads or detergents.

Disclaimer

The instructions in this document have been carefully checked for accuracy and are presumed to be reliable. Bioscript, Inc. and its writers assume no responsibility for inaccuracies and reserve the right to modify and revise this document without notice.

It is always our goal at Bioscript, Inc. to supply accurate and reliable documentation. If you discover a discrepancy in this document, please e-mail your comments to support@bioscript.com, or contact Bioscript Technical Support at the telephone number listed below.

No part of this publication may be placed in a retrieval system, transmitted, or reproduced in any way, including, but not limited to, photograph, photocopy, computer disk or other record, without prior agreement and written permission from:

Bioscript Inc.
5805 Sepulveda Blvd.
Suite 750
Van Nuys, CA 91411
Phone 818.304.7150
Toll Free 888.982.4643
<http://www.bioscript.com>

Bioscrypt One Year Limited Warranty Policy

Bioscrypt warrants to the original consumer purchaser ("Customer") that new Bioscrypt products will be free from defects in material and workmanship for one year from the date the product was shipped from Bioscrypt. For replacement products the warranty on the replacement unit is the remainder of the warranty on the original product or ninety (90) days, whichever is longer. The Customer is responsible for making any claims for shipment damage (evident or concealed) with the freight carrier. Bioscrypt must be notified within thirty days of shipment of incorrect materials.

If a defect is discovered, Bioscrypt's sole obligation shall be to repair or replace the Bioscrypt product(s) at its sole discretion at no charge, provided it is returned to Bioscrypt during the warranty period and is shipped freight and insurance prepaid. Merchandise must be properly packaged to prevent damage during shipping. Before returning a Bioscrypt product, contact Bioscrypt Technical Service to obtain a Return Material Authorization (RMA) number. No product may be returned whether in warranty or out of warranty without first obtaining approval from Bioscrypt. The model number, invoice number, and serial number may be required for warranty service.

This warranty shall not apply to any product or any part of a product, which in the judgment of Bioscrypt, has been subjected to misuse, negligence, alteration, accident, improper maintenance, or damage by excessive physical or electrical stresses. Tampering, such as opening the housing of a biometric reader or replacing parts will void this warranty. The warranty is void if the serial number of the Bioscrypt product has been

defaced, altered, or removed or if the product has been modified. Repair and replacement parts will be furnished on an exchange basis and may be either reconditioned or new. All replaced parts or products become the property of Bioscrypt. This warranty may also be voided for failure to comply with Bioscrypt's return policy.

The warranty is not applicable to:

- Abnormal wear and tear
- Damage caused during installation
- Damage caused by the equipment or system with which the biometric reader is used
- Damage caused by modification or repairs not made or authorized by Bioscrypt
- Damage caused by improper packaging
- Damage caused by lack of ESD protection
- Merchandise that is determined to be stolen

All Veri-Series units have an operating temperature range of 0°-60° Celsius (32°-140° Fahrenheit). In addition, the Veri-Series product line has a relative humidity operating range of 0-95% non-condensing. Any device used outside that temperature or humidity range requires an enclosure with thermal or humidity control that can maintain a consistent environment within the stated operating ranges.

The newest Bioscrypt Veri-Series products are designed to be weather resistant but no sensor technology exists today that can work in all weather environments. If a Bioscrypt Veri-Series product is not used in a completely indoor environment, then a protective enclosure is required to shield the unit from moisture, dust, other contaminants and temperatures outside the stated operating

range. Product failures resulting from exposure to these conditions are not covered under the product warranty.

For outdoor installations, Bioscrypt does offer an enclosure to protect the device from exposure to moisture, dust, other contaminants and temperatures outside stated operating range. To maintain the Bioscrypt warranty, the Veri-Series unit must be installed in a Bioscrypt certified outdoor enclosure. When used properly, this enclosure will protect Veri-Series devices in most environments, but not all. The Customer is responsible for determining whether the offered enclosure will appropriately shield Veri-Series devices in their specific installation. Product failures resulting from exposure to moisture, dust, other contaminants and temperatures outside stated operating range, even if an enclosure is used, are not covered under the product warranty.

This warranty is exclusive and in lieu of all others, whether oral or written, expressed or implied. Bioscrypt specifically disclaims any and all implied warranties, including without limitation, warranties of merchantability and fitness for any particular purpose. No Bioscrypt dealer, agent, or employee is authorized to make any modification, extension or addition to this warranty.

Bioscrypt Return Policy and Procedures

Bioscrypt must be notified within thirty days of the date that a defect is discovered. Bioscrypt will then issue a Return Material Authorization (RMA) number which the Customer must include with all correspondence and display on the outside of the shipping container when returning the product. Any products returned later than 30 days after issuance of an RMA may be subject to review as to whether the authorization to return is still warranted.

All Bioscrypt products must be shipped freight and insurance prepaid, in the original shipping container or equivalent. A written description of the defect together with a copy of the invoice and the name of the Dealer who sold the Bioscrypt product must be shipped with the product. All defects must be reproducible at Bioscrypt's location to qualify for this limited warranty.

For shipping addresses and return authorization contact Bioscrypt Technical Support. Warranty repairs do not re-initiate the warranty period. For repaired or replaced products the warranty on the replacement unit is the remainder of the warranty on the original product or 90 days, whichever is longer.

Bioscrypt will return a repaired or replacement product via ground freight and insurance prepaid. If the Customer desires an airfreight or other expedited return shipping method, then they must agree to pay for the expedited shipping. Returned products that are found to be free of defects may be subject to a \$150.00 handling fee and will be returned at the Customer's expense.

Carefully read the following regarding billable repairs:

By shipping product to Bioscript using the RMA provided by the Technical Support Department, you are agreeing to the following terms:

For all non-warranty repairs or billable repairs, the customer will be responsible for charges associated with parts, labor and shipping/freight to and from the Bioscript repair facility. Once the product is evaluated/inspected by a repair technician, Bioscript will provide the customer with an estimate of the aforementioned charges.

If any discrepancies arise between the final cost and the initial estimate, the customer will be notified.

The customer shall approve any estimate for non-warranty repairs or billable repairs and shall pay the estimated charges before the equipment is repaired. In the event the customer fails to either: (a) pay the estimated charges within 60 days of such estimate; or (b) arrange for return of the un-repaired equipment to the customer at customer's cost, Bioscript will consider the equipment abandoned and will dispose of the equipment.

30 Day Return for Credit

Bioscrypt is a leading biometric company, specializing in fingerprint and verification systems. We are confident that customers will be pleased with Bioscrypt products. However, if you are not, and you purchased your merchandise directly from Bioscrypt, new products can be returned for credit within the first 30 days under the following conditions:

- You have received an RMA from Bioscrypt Technical Support and the item is returned in accordance with the Bioscrypt Return Policy and Procedures.
- Return Items are accompanied by proof of purchase.
- All original materials (accessories, manuals, CDs) are returned with the item.
- The item is in re-sellable condition. If there are any questions regarding re-sellable condition Bioscrypt will have the final decision as to whether an item can be returned or exchanged.

If you did not purchase your product directly from Bioscrypt Inc, please contact your retailer for their return policy.

Notices

The Veri-Series line of products has been tested for compliance with all applicable international standards. The resulting approvals are listed below, and are additionally printed on the labeling located on the rear panel of the product.

The power supply offered by Bioscrypt is CE and CSA approved and UL listed.

V-Flex	FCC, UL 294, CSA, CE
V-Prox	FCC, UL 294, CSA, CE
V-Pass	FCC, UL 294, CSA, CE
V-Smart	FCC, UL 294, CSA, CE
V-Station	FCC, UL 294, CSA, CE

For more information on approvals, notices, and declarations of conformance for all Veri-Series products, please see Appendix A and B within the *Veri-Series Installation Guide*. Important FCC, CE, and R&TTE information is listed there.

FCC Information to Users @ FCC 15.21 & 15.105

For Class B Unintentional Radiators:

This equipment has been tested and found to comply with the limits for a Class B digital devices, pursuant to Part 15 of the FCC Rules. These limits

are designed to provide reasonable protection against harmful interference in a residential installation. This equipment generates, uses, and can radiate radio frequency energy and, if not installed and used in accordance with the instruction manual, may cause harmful interference to radio communications. However, there is no guarantee that interference will not occur in a particular installation. If this equipment does cause harmful interference to radio or television reception, which can be determined by turning the equipment off and on, the user is encouraged to try to correct the interference by one of more of the following measures:

- *Reorient or relocate the receiving antenna*
- *Increase the separation between the equipment and receiver*
 - *Connect the equipment into an outlet on a circuit different from that to which the receiver is connected.*
 - *Consult the dealer or an experienced radio/TV technician for help.*

Warning: *Changes or modifications not expressly approved by BIOSCRYPT INC. could void the user's authority to operate the equipment*

Technical Support Contact Information:

Telephone: 866.304.7180 (toll free)

818.304.7180

Fax: 818.304.7187

Email: support@bioscript.com

Web: <http://www.bioscript.com>

Hours: 5:30A – 5:00P PST (Monday – Friday)

Address **Bioscript Inc.**

Technical Support Department

5805 Sepulveda Blvd., Suite 750

Van Nuys, CA 91411

For your records

Model: _____

Serial Numbers: _____

Installer/Reseller: _____

Installation Date: _____

Notes:

Corporate & Canadian Office

505 Cochrane Dr,
Markham, ON, Canada L3R
8E3

T 905 940 7750

F 905 940 7642

www.bioscript.com

U.S. Office

5805 Sepulveda Blvd., Suite
750

Van Nuys, CA 91411

T 818 304 7150

F 818 461-0843

U.K. Office

35 Jackson Court, Hazlemere
High Wycombe,

Buckinghamshire

England HP15 7TZ

T +44 (0) 1494 814 404

F +44 (0) 1494 815 513