

# PROdry Fast Drying Carpet Cleaner

## USER'S GUIDE 7350 SERIES



- 3 Safety Instructions
- 4 Product View
- 5 Assembly
- 6 Special Features
- 7-10 Operation
- 10-11 Maintenance and Care
- 12 Troubleshooting
- 13 Consumer Services
- 14 Replacement Parts
- 15 Additional Accessories
- 16 Warranty



## Thank you for buying a BISSELL PROdry carpet cleaner

We're glad you purchased a BISSELL PROdry carpet cleaner. Everything we know about floor care went into the design and construction of this complete, high-tech home cleaning system. By purchasing this product you are helping BISSELL with our commitment to reducing our impact on the environment through an expanding range of sustainable design efforts.

Your carpet cleaner is well made, and we back it with a limited one-year warranty. We also stand behind it with a knowledgeable, dedicated Consumer Services department, so, should you ever have a problem, you'll receive fast, considerate assistance.

My great-grandfather invented the floor sweeper in 1876. Today, BISSELL is a global leader in the design, manufacture, and service of high quality homecare products like your carpet cleaner.

Thanks again, from all of us at BISSELL.

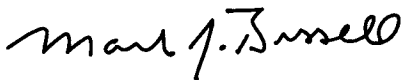

**Mark J. Bissell**

**President and Chief Executive Officer**

# IMPORTANT SAFETY INSTRUCTIONS

When using an electrical appliance, basic precautions should be observed, including the following:

Read all instructions before using your PROdry

**⚠ WARNING:** To reduce the risk of fire, electric shock, or injury:

- Do not immerse.
- Use only on surfaces moistened by cleaning process.
- Always connect to a properly grounded outlet.
- See Grounding Instructions.
- Unplug from outlet when not in use and before conducting maintenance or troubleshooting.
- Do not leave machine when it is plugged in.
- Do not service machine when it is plugged in.
- Do not use with damaged cord or plug.
- If appliance is not working as it should, has been dropped, damaged, left outdoors, or dropped into water, have it repaired at an authorized Service Center.
- Use indoors only.
- Do not pull or carry by cord, use cord as a handle, close door on cord, pull cord around sharp corners or edges, run appliance over cord, or expose cord to heated surfaces.
- Unplug by grasping the plug, not the cord.
- Do not handle plug or appliance with wet hands.
- Do not put any object into appliance openings, use with blocked opening, or restrict air flow.
- Do not expose hair, loose clothing, fingers or body parts to openings or moving parts.
- Do not pick up hot or burning objects.
- Do not pick up flammable or combustible materials (lighter fluid, gasoline, kerosene, etc.) or use in the presence of explosive liquids or vapor.
- Do not use appliance in an enclosed space filled with vapors given off by oil base paint, paint thinner, some moth proofing substances, flammable dust, or other explosive or toxic vapors.
- Do not pick up toxic material (chlorine bleach, ammonia, drain cleaner, gasoline, etc.).
- Do not modify the 3-prong grounded plug.
- Do not allow to be used as a toy.
- Do not use for any purpose other than described in this User's Guide.
- Do not operate the appliance unless the sole plate is securely assembled in the location provided.
- Do not unplug by pulling on the cord.
- Use only manufacturer's recommended attachments.
- Use only cleaning products formulated by BISSELL for use in this appliance to prevent internal component damage. See the cleaning fluid section of this guide.
- Keep openings free of dust, lint, hair, etc.
- Do not point attachment nozzle at people or animals
- Keep appliance on a level surface.
- Unplug before connecting TurboBrush® tool

- Turn off all controls before unplugging.
- Be extra careful when cleaning stairs.
- Close attention is necessary when used by or near children.
- Do not use a flammable or combustible liquid to clean a floor.
- Always install float before any wet pick-up operation.

## SAVE THESE INSTRUCTIONS.

THIS MODEL IS FOR HOUSEHOLD USE ONLY.  
Commercial use of this unit voids the manufacturer's warranty.

## GROUNDING INSTRUCTIONS

This appliance must be connected to a grounded wiring system. If it should malfunction or break down, grounding provides a safe path of least resistance for electrical current, reducing the risk of electrical shock. The cord for this appliance has an equipment-grounding conductor and a grounding plug. It must only be plugged into an outlet that is properly installed and grounded in accordance with all local codes and ordinances.

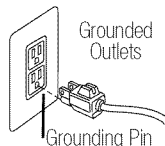

**⚠ WARNING:** Improper connection of the equipment-grounding conductor can result in a risk of electrical shock. Check with a qualified electrician or service person if you aren't sure if the outlet is properly grounded. **DO NOT MODIFY THE PLUG.** If it will not fit the outlet, have a proper outlet installed by a qualified electrician. This appliance is designed for use on a nominal 120-volt circuit, and has a grounding attachment plug that looks like the plug in the drawing above. Make certain that the appliance is connected to an outlet having the same configuration as the plug. No plug adapter should be used with this appliance.

## Product view



### WARNING:

To reduce the risk of fire and electric shock due to internal component damage, use only BISSELL cleaning fluids intended for use with the deep cleaner. Non-BISSELL cleaning solutions may harm the machine and void the warranty.

## Cleaning fluid

Keep plenty of genuine BISSELL Fiber Cleansing Formula™ on hand so you can clean whenever it fits your schedule. Always use genuine BISSELL deep cleaning formulas. Non-BISSELL cleaning solutions may harm the machine and will void the warranty.



48 oz. BISSELL Fiber Cleansing Formula™ with Scotchgard™ Protector  
**item # 0710**



48 oz. BISSELL Multi-Allergen Removal™ Formula™ with Scotchgard™ Protector  
**item # 0720**



48 oz. BISSELL Pet Odor and Soil Removal™ Formula™ with Scotchgard™ Protector  
**item # 0730**



48 oz. BISSELL Natural Orange Extract Formula™ with Scotchgard™ Protector  
**item # 0740**



48 oz. BISSELL Lavender Essence Formula™ with Scotchgard™ Protector  
**item # 0750**



42.67 oz. BISSELL 3X Concentrated Fiber Cleansing Formula™ with Scotchgard™ Protector  
**item # 0716**



22 oz. BISSELL Tough Stain PreCleaner™  
**item # 0400**

## How to use this guide

This user's guide has been designed to help you get the maximum satisfaction from your PROdry carpet cleaner. You'll find assembly and operating instructions, safety precautions, as well as maintenance and troubleshooting instructions. Please read this user's guide thoroughly before assembling your carpet cleaner.

Your carpet cleaner comes in three easy to assemble components:

- Handle assembly
- Upper hose wrap
- Lower body assembly

Four Phillips head screws are included and can be found taped to the handle assembly.

## Assembly

The only tool you will need to assemble your PROdry is a Phillips head screwdriver.

1. Slide upper handle into lower body assembly and secure with 2 screws.
2. Attach upper hose wrap using 2 screws.
3. Wrap hose clockwise around the upper and lower hose wraps as shown on page 4. Be sure to properly secure grip into the notched holder.
4. Keep hose locked in place with the secure latch.
5. Wrap the power cord as shown on page 4.
6. Place Oxy Gen2 PowerTool in the center tool caddy and the tough stain tool on the hose wand.



## WARNING:

Do not plug in your cleaner until you have completely assembled it per the following instructions and are familiar with all instructions and operating procedures.

**Tip:** Regular carpet cleaning can reduce dust and allergens in your home.

1.

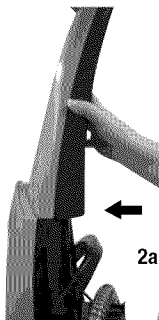

2a.

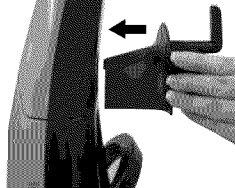

2b.

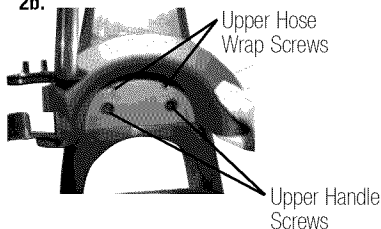

## Special features of your BISSELL PROdry carpet cleaner

Your BISSELL PROdry carpet cleaner is a home cleaning system that uses a combination of hot tap water, BISSELL advanced cleaning formula, the innovative TLR PowerRoller and suction to safely clean carpet and area rugs.

### **TLR PowerRoller™**

The TLR PowerRoller is designed for great cleaning performance with fast drying results. It **Traps, Lifts and Removes** dirt and debris. Unlike traditional carpet cleaners, where cleaning solution is sprayed directly into the carpet, the TLR PowerRoller absorbs the majority of the spray from the machine, meaning your carpet and area rugs get cleaned and revitalized, while still allowing you to get back on them in less than 30 minutes. When in the upright position, for storage or tool use, the TLR PowerRoller is lifted off the floor surface and held in space. This will also help the TLR PowerRoller dry between uses. The TLR PowerRoller can be washed or replaced as needed.

### **Ready Tools™ Dial**

The Ready Tools feature allows you to choose between FLOOR CLEANING or cleaning with TOOLS simply by turning the dial. The TOOLS setting allows for above floor cleaning of upholstery, stairs, creases along baseboards and other hard to reach areas. Simply choose the tool that is appropriate for the job, attach it to the flexible hose and you are ready to go.

### **Oxy Gen2 PowerTool**

The Oxy Gen2 PowerTool is an advanced stain fighting tool. By adding Oxy Gen2 multi-purpose formula to the tool, tough stains such as coffee, juice, cola and red wine are easier to clean up. The tool can store ready to use with the Oxy Gen2 formula in it.

### **Easy carry handle**

Located in the back of the machine, the easy carry handle makes it easy to carry the machine. Refer to page 4 for location.

## **WARNING:**

To reduce the risk of fire, use only BISSELL advanced deep cleaning formula for full size machines in your carpet cleaner. Use of cleaning formulas that contain lemon or pine oil may damage this appliance and void the warranty. Chemical spot cleaners or solvent-based soil removers should not be used. These products may react with the plastic materials used in your deep cleaner causing cracking or pitting.

# Operation

## Before you clean

1. **If desired**, move furniture to another area if cleaning an entire room.
2. **Vacuum** area with a dry vacuum cleaner before cleaning
3. Plan your cleaning route to leave an exit path. It is best to begin cleaning the corner farthest from your exit

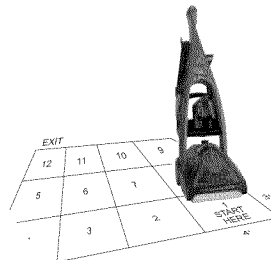

## Fill the clean/solution tank

1. Remove the clean/solution from the base of the machine by pulling up and out from the back. You can also detent the handle and pull the tank straight up if you desire.
2. Unscrew the black cap and red insert. Remove.
3. Fill the tank up to the FILL LINE with hot tap water.
4. Add 3 ounces of formula (Always use genuine BISSELL formulas to maximize cleaning and for the safety of your machine).  
**OR** If using a BISSELL 3X Concentrate add 1 ounce of formula.
5. Replace the cap and insert and tighten by turning clockwise.
6. Replace the clean/solution tank back into the machine. Be sure that the cap is seated in the receiver.

## Carpet cleaning

1. Make sure the ReadyTools Dial is in the FLOOR CLEANING position.
2. Plug the PROdry into the proper outlet and turn the power **ON ( I )** using the switch in the back.
3. With your foot, press the gray handle release lever located on the back of the unit. Take care to notice the way the machine floats forward.
4. While pressing the spray trigger make 1 forward wet pass and another 1 back. Repeat once and move on to the next section of carpet or area rug to be cleaned. Take care not to run over loose objects of the edges of area rugs.

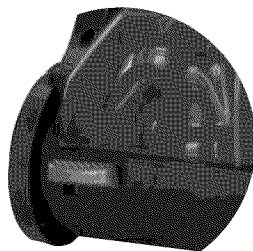

**Tip:** Thorough vacuuming before carpet cleaning will prevent early clogging of the lint screen.

## Operation

### Empty the dirty water tank

1. When the dirty water tank level reaches the FULL line, when the float trips or when finished carpet cleaning, turn power switch OFF (O).
2. Remove dirty water tank by lifting straight up and carry it to the sink or wherever you plan to dump the dirty water.
3. Remove the tethered cap on the rear of the tank.
4. Pour out the dirty water, rinse tank and replace the cap.
5. To continue carpet cleaning refer back to page 7 beginning with "Fill the clean/solution tank."

If cleaning is complete, refer to the "Maintenance and care" section on page 11.

### Pretreating (optional)

#### 1. Pretreating (optional)

Pretreating is recommended to improve cleaning effectiveness for heavily soiled carpet in high traffic areas such as entry ways and hallways. Please keep in mind that pretreating will wet the carpet and could impact dry time.

To pretreat:

- A. Using the BISSELL Tough Stain Pre-cleaner, generously spray evenly over soiled area, **do not overwet**.
- B. Wait 3-5 minutes before cleaning.
- C. Clean as normal using your BISSELL PROdry, following the instructions on page 7.



### Ready Tools™ (cleaning with attachments)

Your PROdry carpet cleaner comes equipped with a hose and at least two attachments for cleaning stairs, upholstery, stains and more.

**Important! If using the machine to clean upholstery, check upholstery tags.**

1. Check manufacturer's tag before cleaning. "W" or "WS" on the tag means you can use your PROdry. If the tag is coded with "X" or "S" (with a diagonal strike through), or says "Dry Clean Only," do not proceed. Do not use on velvet or silk. If manufacturer's tag is missing or not coded, check with your furniture dealer.

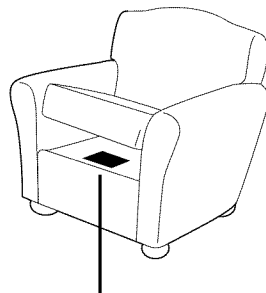

Manufacturer's tag

## **WARNING:**

To reduce the risk of fire and electric shock due to internal component damage, use only BISSELL cleaning fluids intended for use with the carpet cleaner. Non-BISSELL cleaning solutions may harm the machine and void the warranty.



## Operation

### **Ready Tools™ (continued)**

2. Check for colorfastness in an inconspicuous place.
3. If possible, check upholstery stuffing. Colored stuffing may bleed through fabric when wet.
4. Plan activities to give upholstery time to dry.
5. Vacuum thoroughly to pick up loose debris and pet hair. Use a vacuum with a brush attachment and a crevice tool to clean in fabric folds and tufts.
6. To begin cleaning with attachments, follow the instructions on page 7 for filling the clean/solution tank.
7. Set the ReadyTools dial to the TOOLS setting. This will allow for suction from the hose.
8. Attach the desired cleaning tool to the end of the hose.
9. Clean by pressing the trigger to spray solution onto the area to be cleaned. Slowly move the tool back and forth over the soiled surface. Release the trigger to suction dirty water. Continue to clean in the area, working in small sections, until dirt is removed.  
**Caution: Do Not Overwet.**
10. When finished cleaning, remove and rinse tool(s) in clean, running water.
11. It is recommended that you suction clean water from the tap to rinse out the hose.
12. Before wrapping hose onto tool rack, lift end of hose and stretch out to ensure all water is cleared from hose.
13. Wrap flex hose around tool rack.
14. Empty collection tank and rinse out, following instructions on page 10.
15. If the ReadyTools dial becomes difficult to turn, the diverter assembly that holds the dial may need to be cleaned. To clean, flush hot water through the nozzle. Make sure the dial is set to FLOOR CLEANING.



## Operation

### Oxy Gen2 PowerTool™

To use the Oxy Gen2 PowerTool:

1. Pull out the rubber stopper in the tank.
2. Fill with Oxy Gen2® formula.
3. Replace the rubber stopper and attach the tool to the hose grip.
4. Refer to page 9 “Ready Tools” steps 9-15.

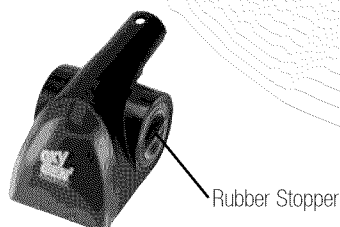

## Maintenance and care

### Machine care

For best results, a few simple steps can assure your machine is well maintained after your cleaning is complete.

1. Turn power switch **OFF ( 0 )**. Unplug the machine and wrap the power cord.
2. After emptying the collection tank, rinse it with running hot tap water, taking care to clean all around the interior.
3. Clean out the lint screen if necessary by wiping clean any visible residue.
4. Replace the collection water tank on the machine.
4. Any loose hair or debris can be pulled from the TLR PowerRoller and thrown away.
5. To clean the attachments, remove from hose and rinse in clean, running water. Dry before storing. Clean the hose by suctioning clean water from the tap. Before wrapping back on machine, lift end of hose and stretch out to ensure all water is cleared from hose while still suctioning.
6. Wipe the machine's exterior with a soft cloth and store properly, refer to page 11.

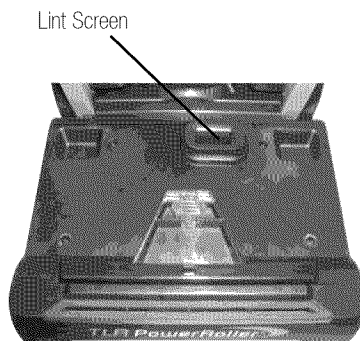

# Maintenance and care

## Cleaning/replacing the TLR Power Roller

1. Turn power switch to OFF ( 0 ) and unplug the machine.
2. Remove both tanks, detent the handle and turn the machine on its back.
3. Remove the 6 screws from the sole plate using a Phillips head screwdriver, set 6 screws and sole plate aside.
4. Turn the machine on its side so the cord side is against the floor.
5. Remove the 2 screws from the belt guard and set aside  
**Note: These 2 screws are the same as the 6 sole plate screws).**  
Remove the top of the belt guard.
6. Unhook the belt from the TLR PowerRoller and slide the roller down through the hole in the belt guard bottom. Slide the roller up off the metal dowel (which is attached to the swing arm).
7. Clean the TLR PowerRoller by rinsing with hot water and mild soap. Allow to dry before replacing if desired.
8. To replace, slide the TLR PowerRoller on to the metal dowel with the taller cog at the top. Push the taller cog of the roller back up through the hole in the belt guard bottom and re-attach the belt. Place the belt guard top into position over the bottom half and tighten together with 2 screws.
9. Turn the machine on to its back and attach the second swing arm. Be sure the arm is properly in place both on the TLR PowerRoller and in the base. Push the TLR PowerRoller down so it is nested under the nozzle.
10. Re-attach the sole plate using the 6 screws.

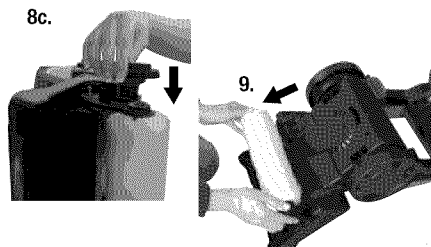
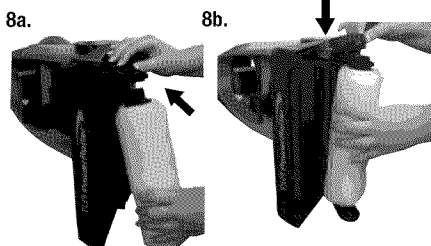
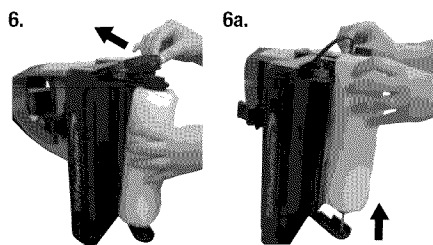
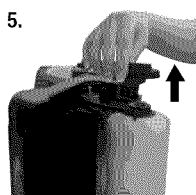
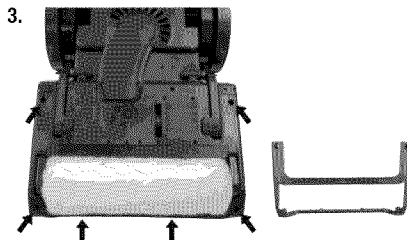

## Machine storage

Put the unit away in a closet or basement for the next use. Store cleaner in a protected, dry area. Since this product uses water, it must not be stored where there is a danger of freezing. Freezing will damage internal components and void the warranty.

## Troubleshooting



### **WARNING:**

To reduce the risk of fire, electric shock or injury, unplug from the outlet before servicing.

#### **Reduced Spray OR No Spray**

##### **Possible cause**

1. Clean/solution tank may be empty
2. Clean/solution tank may not be seated properly
3. Pump may have lost prime

#### **No spray through the hose**

##### **Possible cause**

1. Pump may not be primed

#### **TLR PowerRoller Does Not Turn**

##### **Possible cause**

1. The brush belt is off or broken

#### **Machine not picking up solution**

##### **Possible cause**

1. Collection tank may not be seated properly
2. ReadyTools dial may be on TOOLS
3. Float may have shut off
  
4. Collection tank may be full

##### **Remedies**

1. Turn power switch OFF; Refill tank with clean hot tap water and formula
2. Turn power switch OFF; remove tank and reseal
3. Turn power switch OFF ( **0** ); after 1 minute turn ON ( **I** ) and depress spray trigger

Be sure there is cleaning formula in the clean/solution tank, it will make the machine prime faster

##### **Remedies**

1. Turn ReadyTools dial to FLOOR CLEANING and depress trigger for a few seconds until you see suction coming up the nozzle. Turn ReadyTools dial back to TOOLS

##### **Remedies**

1. Refer to page 11, steps 1-5 for instructions on how to access the belt
2. Look at the belt and check for breakage or misalignment on the cogs. IF there is no evidence, replace all parts following steps 8-11.
3. In the event your belt is broken, a replacement belt may be ordered at [www.bissell.com](http://www.bissell.com) or by calling BISSELL consumer services at 800-237-7691. Refer to the parts list on page 14. Complete installation instructions will come with the replacement belt

##### **Remedies**

1. Turn power switch OFF; reseal tank
2. Turn ReadyTools dial to FLOOR CLEANING
3. Turn power switch OFF and empty tank if necessary. If tank is not full, wait 30 seconds and turn power switch ON
4. Turn power switch OFF and empty tank

## Troubleshooting

Other maintenance or service not included in the manual should be performed by an authorized service representative.

**Thank you for selecting a BISSELL product.**

**Please do not return this product to the store**

For any questions or concerns, BISSELL is happy to be of service. Contact us directly at 1-800-237-7691.

## BISSELL Consumer Services

For information about repairs or replacement parts, or questions about your warranty, call:

**BISSELL Consumer Services**  
**1-800-237-7691**

Monday - Friday 8 a.m. — 10 p.m. EST

Saturday 9 a.m. — 8 p.m. EST

Or write:

BISSELL HOMECARE, INC

PO Box 3606

Grand Rapids MI 49501

ATTN: Consumer Services

Or visit the BISSELL website - **[www.bissell.com](http://www.bissell.com)**

When contacting BISSELL, have model number of unit available.

Please record your Model Number: \_\_\_\_\_

Please record your Purchase Date: \_\_\_\_\_

**NOTE: Please keep your original sales receipt. It provides proof of date of purchase in the event of a warranty claim. See Warranty on page 16 for details.**

## Replacement parts

Item	Part No.	Part Name
1	203-7204	Collection Tank Assembly
2	203-7206	Collection Tank Cap w/ Tether
3	203-7207	Clean/Solution Tank Assembly
4	203-7211	Spray Tip
5	203-7210	Spray Tip Cover
6	203-7223	TLR PowerRoller Assembly (2 pack)
7	203-7226	Replacement Brush Belt (with instructions)
8	203-7241	Oxy Gen2 PowerTool Cap

1

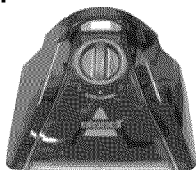

2



3

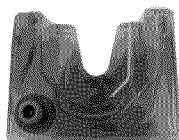

4



5

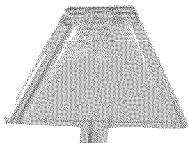

6

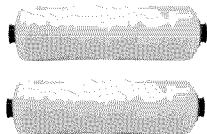

7



8



## Additional accessories

These items are available for purchase as accessories for your BISSELL PROdry:  
To purchase call 1-800-237-7691 or visit [www.bissell.com](http://www.bissell.com).

Item	Part No.	Part Name
1	203-7240	Oxy Gen2 PowerTool™
2	203-7238	3" Tough Stain Tool
3	203-6653	4" Upholstery Tool
4	203-6654	6" Stair Tool
5	203-6652	Powered TurboBrush® Hand Tool
6	203-7240	Spraying 2-in-1 Crevice Tool
7	203-6655	Spraying Crevice Tool
8	210-3040	Mesh Tool Storage Bag (Bag Only)

1



2



3



4

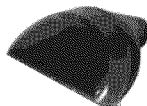

5



6



7



8



**Cleaning Formula:** Refer to bottom of page 4 of this guide for a full selection of cleaning formula available for purchase.

For a complete list of replacement parts, cleaning formulas, and accessories available for your BISSELL deep cleaner please visit [www.bissell.com](http://www.bissell.com) or contact BISSELL Consumer Services at 800.237.7691.

## Warranty - BISSELL PROdry

This warranty gives you specific legal rights, and you may also have other rights which may vary from state to state. If you need additional instruction regarding this warranty or have questions regarding what it may cover, please contact BISSELL Consumer Services by E-mail, telephone, or regular mail as described below.

### Limited One Year Warranty

Subject to the **\*EXCEPTIONS AND EXCLUSIONS** identified below, upon receipt of the product BISSELL Homecare, Inc. will repair or replace (with new or remanufactured components or products), at BISSELL's option, free of charge from the date of purchase by the original purchaser, for one year any defective or malfunctioning part.

See information below on "If your BISSELL product should require service".

This warranty applies to product used for personal, and not commercial or rental service. This warranty does not apply to fans or routine maintenance components such as filters, belts, or brushes. Damage or malfunction caused by negligence, abuse, neglect, unauthorized repair, or any other use not in accordance with the User's Guide is not covered.

### If your BISSELL product should require service:

Contact BISSELL Consumer Services to locate a BISSELL Authorized Service Center in your area.

If you need information about repairs or replacement parts, or if you have questions about your warranty, contact BISSELL Consumer Services.

#### Website or E-mail:

[www.bissell.com](http://www.bissell.com)

Use the "Customer Services" tab.

#### Or Call:

BISSELL Consumer Services

1-800-237-7691

Monday - Friday 8 a.m. - 10 p.m. ET

Saturday 9 a.m. - 8 p.m. ET

#### Or write:

BISSELL Homecare Inc.

PO Box 3606

Grand Rapids MI 49501

ATTN: Consumer Services

BISSELL HOME CARE, INC. IS NOT LIABLE FOR INCIDENTAL OR CONSEQUENTIAL DAMAGES OF ANY NATURE ASSOCIATED WITH THE USE OF THIS PRODUCT. BISSELL'S LIABILITY WILL NOT EXCEED THE PURCHASE PRICE OF THE PRODUCT.

**Some states do not allow the exclusion or limitation of incidental or consequential damages, so the above limitation or exclusion may not apply to you.**

#### **\*EXCEPTIONS AND EXCLUSIONS FROM THE TERMS OF THE LIMITED WARRANTY**

THIS WARRANTY IS EXCLUSIVE AND IN LIEU OF ANY OTHER WARRANTIES EITHER ORAL OR WRITTEN. ANY IMPLIED WARRANTIES WHICH MAY ARISE BY OPERATION OF LAW, INCLUDING THE IMPLIED WARRANTIES OF MERCHANTABILITY AND FITNESS FOR A PARTICULAR PURPOSE, ARE LIMITED TO THE ONE YEAR DURATION FROM THE DATE OF PURCHASE AS DESCRIBED ABOVE.

Some states do not allow limitations on how long an implied warranty lasts, so the above limitation may not apply to you.



©2008 BISSELL Homecare, Inc.  
Grand Rapids, Michigan  
All rights reserved. Printed in China  
Part Number 120-4035  
Rev 7/08  
Visit our website at: [www.bissell.com](http://www.bissell.com)  
Scotchgard is a trademark of 3M

