



# 7849

## FIELD STRENGTH METER

### USER MANUAL

This product contains one or more programs protected under international and US copyright laws as unpublished works. They are confidential and proprietary to Dolby laboratories. Their reproduction or disclosure, in whole or in part, or the production of derivative works there from without the express permission of Dolby Laboratories is prohibited. Copyright 2003-2005 by Dolby Laboratories. All rights reserved.



Thank you for purchasing this SEFRAM product and therefore trusting our company. Our different teams (research department, production, sales department, after-sales service...) are aiming at satisfying your wishes by designing and updating very advanced appliances.

To obtain the best performance from this product please read this manual carefully.

For more information please contact our different services

**04 77 59 01 01**

E-mail Sales department: [sales@sefram.fr](mailto:sales@sefram.fr)

E-mail After-sales: [sav@sefram.fr](mailto:sav@sefram.fr)

E-mail Technical support: [support@sefram.fr](mailto:support@sefram.fr)

Fax: +33 (0)4 77 57 23 23

Web: [www.sefram.fr](http://www.sefram.fr)



Copyright Sefram, 2013. All rights reserved.

Any total or partial reproduction of this document must be submitted for Sefram written authorisation.

## **GUARANTEE**

Your instrument is guaranteed for one year for labor and parts against any manufacturing defect and/or functioning hazard. This guarantee extends from the delivery date and ends 365 calendar days later.

In case of guarantee contract, this will cancel or replace these guarantee conditions hereabove.

The guarantee conditions by SEFRAM are available on the website [www.sefram.com](http://www.sefram.com). The general guarantee conditions should prevail on the following conditions that they sum up.

This guarantee does not cover the result of any abnormal use, handling mistake or mistake in the storage conditions outside the defined range.

In case of application of the guarantee, the user shall return, at its own expenses, the relevant appliance to our factory:

SEFRAM Instruments & Systèmes  
Service Après-vente  
32, Rue Edouard MARTEL  
BP 55  
42009 SAINT-ETIENNE CEDEX 2

And add a description of the observed breakdown to the appliance.

The standard supplies provided with the appliance (cables, outlets...), the consumables (batteries ...) and the optional supplies (suitcases...) are guaranteed for 3 months against any manufacturing defect.

Such items as a suitcase, a LCD screen or a touchpad are guaranteed only for a normal use.

The guarantee does not cover wearing, accidental breaks or consecutive to a shock or any abnormal use.

The factory options integrated to the appliance are guaranteed for the same duration as the appliance itself.

In case of replacement or repair of the product, the remaining guarantee duration shall be:

- The remaining duration of the guarantee if the appliance is still under guarantee
- If the guarantee duration is less than 90 days, the replaced part is guaranteed for 90 days

Any replacement part becomes the property of the user and the exchanged parts become the property of SEFRAM.

In case of intervention by an insurance company, the product becomes the property of the insurance company upon its exclusive request. Else, it shall remain property of the user.

The guarantee covers exclusively the materials manufactured and provided by SEFRAM.

Any intervention by the user or any third party without prior authorization by the company voids the guarantee.

The user shall be responsible for the return of its appliance to our site. Hence, it shall provide for a conditioning that shall correctly protect the appliance while shipping. It shall subscribe, at its own expenses, any insurance required for the transport.

The SEFRAM company reserves the right to refuse any product wrongly conditioned and not to take in charge any break consecutive to the transport.

Particular case of the battery: There is a Li-ion battery as a standard equipment of this appliance. It shall not be transported outside the appliance. In no case shall the user replace it. Its replacement in the factory is necessary to check the charge system and the protective securities.

### **What to do in case of malfunction?**

In case of malfunction or for any advice for use, please contact the technical support by SEFRAM Instruments & Systèmes: 0825 56 50 50 / 2

A technician shall answer you and give you any information required to solve your problem.

### **What to do in case of failure?**

In case of failure of your appliance, please contact the technical support: 0825 56 50 50 / 2

### **Some advice!**

### **Some technical help!**

SEFRAM Instruments & Systèmes commits itself to help you on the phone about the use of your appliance.

Please call or Technical Support:

04 77 59 01 01

Or e-mail:

[support@sefram.fr](mailto:support@sefram.fr)

We thank you for your trust.

## **METROLOGY**

The meteorological conditions of your measurement instrument are defined in the specifications of this notice. Climate and environmental conditions restrict the specifications of your Field Strength Measurer (MDC). SEFRAM checks the characteristics of each appliance one by one on an automatic bench during its manufacture. The adjustment and control are guaranteed under conditions of the ISO9001 certification by facilities in connection with the COFRAC (or equivalent in the context of ILAC reciprocity).

The specified characteristics are considered stable for a period of 12 months from the first use under normal conditions of use.

We recommend a check after 12 months and max. 24 months of use, then every 12 months after 24 months.

For any check of the characteristics, the following average climate conditions shall be maintained ( $23^{\circ}\text{C}\pm 3^{\circ}\text{C} - 50(\pm 20)\% \text{RH}$ ). The MDC should have been working for 0,5 hour before check.

We recommend that you have this control made by our after-sales service (Service Après-Vente) for the best service and preservation of the measuring quality of your instrument.

When a MDC returns to SEFRAM, maximum service is provided with internal updating according to the required adjustments and software updates. In case of shift in the characteristics, your instrument shall be adjusted to recover its original characteristics.

## **PACKAGING**

The packaging of this product is fully recyclable. Its design allows the transport of your instrument under the best possible conditions. Please note that the original packaging should be additionally wrapped in case of transport by air, road or postal.

## **SPARE PARTS**

According to the consumption law of March 17, 2014, Article L111-3 and Decree 2014-1482 of 09/12/2014, SEFRAM informs you of the availability of spare parts of products placed on the market as of March 1, 2015:

Spare parts are not available to the consumer. SEFRAM offers the supply of spare parts during repair by its service.

Consumable parts are provided according to the legislation applicable to them (case of batteries).

SEFRAM is committed to providing parts or alternatives for a period of at least 2 years beyond the warranty period.

## **TABLE OF CONTENTS**

<b>1</b>	<b>Important information</b>	<b>9</b>
1.1	Particular precautions	9
1.2	Security instructions	9
1.3	Symbols and definitions	9
1.4	Conformity and restrictions of the appliance	10
<b>2</b>	<b>Quick start-up</b>	<b>11</b>
2.1	Presentation of the appliance	11
2.2	Signal spotting	12
2.2.1	Checking a terrestrial antenna	12
2.2.2	Installation of a terrestrial antenna	14
2.2.2.1	Use of the spectrum	14
2.2.2.2	Use of the Antenna pointing	16
2.2.3	Installation of a satellite dish	18
<b>3</b>	<b>Presentation</b>	<b>21</b>
3.1	General	21
3.2	Description of the appliance	22
<b>4</b>	<b>Power-up</b>	<b>23</b>
4.1	Battery	23
4.2	Battery charge	23
4.3	External power supply	24
4.4	Turning the appliance on and off	24
<b>5</b>	<b>Man-machine interface</b>	<b>25</b>
5.1	Content of the screen	25
5.2	Changing name or value	27
5.2.1	Changing inside a table	27
5.2.2	Change with selection	28
5.2.3	Change with virtual keyboard	28
5.3	Lists of measurements and setup library	29
<b>6</b>	<b>AUTOSET mode</b>	<b>31</b>
6.1	Terrestrial mode	32
6.2	Satellite mode	32
6.3	Cable Mode	33
6.4	«START » menu key	33
<b>7</b>	<b>Measurement lists</b>	<b>35</b>
7.1	The list page	35
7.2	Modification of a list	36
<b>8</b>	<b>Setup library</b>	<b>39</b>
8.1	The library page	39
8.2	Creation or modification of setups in the library	39
<b>9</b>	<b>Check Sat</b>	<b>42</b>

9.1	Updating satellites .....	43
9.2	Check Sat function .....	43
9.3	Checking the aligned satellite .....	45
9.4	Double Check Sat .....	45
9.4.1	Recall .....	46
<b>10</b>	<b>TERRESTRIAL check.....</b>	<b>47</b>
<b>11</b>	<b>The Measures-TV-Spectrum page .....</b>	<b>50</b>
<b>12</b>	<b>Measures (MEASURES-TV-SPECTRUM).....</b>	<b>51</b>
12.1	Autolock function .....	51
12.2	Modification of parameters .....	52
12.3	Level measurements .....	52
12.4	Satellite band .....	53
12.5	Terrestrial band.....	54
12.6	Thresholds .....	54
12.7	Digital measurements .....	55
12.8	DVB-T/H .....	56
12.9	DVB-T2 /T2 Lite .....	57
12.10	DVB-C.....	58
12.11	DVB-C2.....	59
12.12	DVB-S et DSS .....	60
12.13	DVB-S2.....	61
<b>13</b>	<b>Spectrum analyser .....</b>	<b>62</b>
<b>14</b>	<b>Image and Sound .....</b>	<b>63</b>
14.1	Digital TV .....	63
14.2	Full screen mode .....	63
14.3	Audio.....	64
14.4	Table of services.....	64
<b>15</b>	<b>Remote power supply / LNB – DiSEqC .....</b>	<b>65</b>
15.1	Terrestrial band.....	65
15.2	Satellite band .....	66
15.2.1	Power ON.....	66
15.2.1	Switches.....	67
15.2.1	Positioner .....	68
15.2.2	DCSS .....	69
15.2.2.1	Influence of the DCSS on the spectrum analyzer.....	71
<b>16</b>	<b>Constellation .....</b>	<b>72</b>
<b>17</b>	<b>Echo / Guard interval .....</b>	<b>73</b>
<b>18</b>	<b>Measurement map.....</b>	<b>75</b>
18.1	Out of tolerance values.....	76
<b>19</b>	<b>Configuration .....</b>	<b>77</b>
19.1	Language.....	77
19.2	Frequency map.....	77
19.3	Memories .....	78

19.3.1	View .....	79
19.3.2	Save .....	79
19.3.3	Update.....	80
19.4	Factory recovery .....	81
19.5	Configuration import/export .....	82
<b>20</b>	<b>Software update .....</b>	<b>83</b>
<b>21</b>	<b>Save.....</b>	<b>84</b>
<b>22</b>	<b>Connection of the appliance to a PC.....</b>	<b>85</b>
<b>23</b>	<b>Displayed messages.....</b>	<b>87</b>
23.1	Alert messages .....	87
23.2	Error messages .....	88
<b>24</b>	<b>Maintenance .....</b>	<b>89</b>
<b>25</b>	<b>Technical specifications.....</b>	<b>91</b>
25.1	Technical specifications.....	91
25.2	Digital measurements .....	92
25.3	Divers.....	94
25.4	General specifications .....	95
25.5	Accessories .....	95
25.6	V, dB $\mu$ V, dBmV et dBm conversion.....	96
25.7	Typical values for measurements.....	96
<b>26</b>	<b>Terminology .....</b>	<b>97</b>
<b>27</b>	<b>CE Declaration .....</b>	<b>103</b>



# 1 Important information

Please read carefully the following instructions before using your appliance.

## 1.1 Particular precautions

- Do not use the product for any other use than specified.
- Use the provided charger unit to prevent any deterioration of the appliance and guarantee its measurement characteristics.
- Do not use in a wet environment.
- Do not use in an explosive environment.
- In case of failure or for the maintenance of the appliance, only a qualified personal shall be entitled to work on it. In such a case, it is required to use Sefram spare parts.
- Do not open the appliance: risk of electric shock.
- You should use the F/F adaptor provided with your measuring instrument. Any other adaptor could damage your appliance and jeopardizes the guarantee.
- Do not use gloves, stylus or any other object on to the touchscreen. Handle the screen carefully.

## 1.2 Security instructions

For a correct use of the appliance, it is necessary that users abide by the security and use instructions described in this manual.

Specific warnings appear all along this manual.

In case of need, warning symbols are displayed on the appliance:



## 1.3 Symbols and definitions

Symbols in this manual:



Remark: Shows important information



Key or press zone



Window or display zone showing up after the operation achieved

Symbols on the appliance:



Attention: Refer to the manual. Shows a risk of damage for the material connected to the instrument or to the instrument itself.



Ground: Grounded accessible parts.



Product for recycling.

## 1.4 Conformity and restrictions of the appliance

See chapter [EC Declaration of conformity](#).

## 2 Quick start-up

### 2.1 Presentation of the appliance

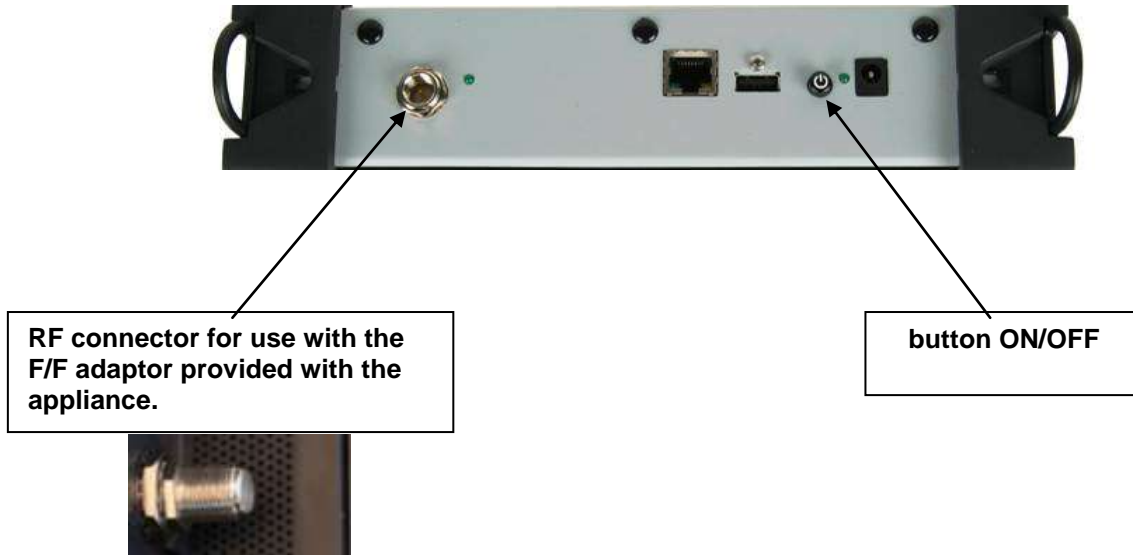

#### Important keys:

7849 is an appliance with a capacitive touchscreen. This requires a soft handling. No glove and no stylus should be used, so that the triggering should be taken into account.

You will recognize the « keys » by their dark grey color (example: the home key: )

You may also access tables by pressing lines (on white or yellow)

<input type="radio"/>	0	DIGITAL+ ASTRA 1	10729 VL	DVB-S2 22000	...
<input type="radio"/>	1	ARD ASTRA 1	10743 HL	DVB-S 22000	...
<input type="radio"/>	2	ANIXE HD ASTRA 1	10773 HL	DVB-S2 22000	...
<input type="radio"/>	3	DIGITAL+ ASTRA 1	10788 VL	DVB-S 22000	...
<input type="radio"/>	4	DIGITAL+ ASTRA 1	10817 VL	DVB-S2 22000	...

#### Welcoming page:

Serial number 001 Version 0.1



Band 5-2200MHz

- ✓ DVB-T/T2
- ✓ DVB-C/C2
- ✓ DVB-S/S2

 HOME  
Access to the main menu

 SAVE  
Access to the current page Save



 **Attention** : To exit a window like in this example below, press the key: 



## 2.2 Signal spotting

The 7849 allows spotting signals in terrestrial or in satellite mode.

In the following chapter, we will see how to spot a signal on three types of installation:

- Checking of a terrestrial antenna (the installation has already been made).
- Installation of a terrestrial antenna.
- Installation of a satellite dish.

### 2.2.1 Checking a terrestrial antenna

In this case, the Autoset function allows a scan of the channels that the antenna detects.

Plug the cable of your antenna to the 7849 (take care to use an adequate adaptor)

Turn your appliance on. Press the Home key 

The Home page appears on screen. Press Autoset 

On this page, press Mode, Terrestrial, then select DVB-T and 8MHz (as here below)

The scan should range from the E21 to the E69 channels, frequency range Europe (you may reduce the number of channels to scan if you know the range of the emitter where the antenna points at: the scan will be faster)

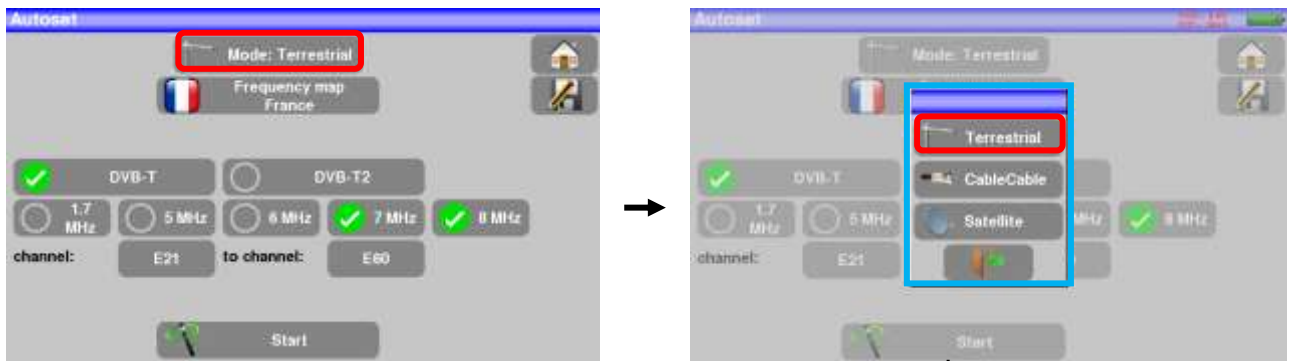



Press START. The appliance searches until the end of the scan and turns directly to the Measurement plan mode. If channels were found, the appliance makes measurements continuously (C/N-level, then BER/MER) on the detected channels. If no channel has been found, see the next chapter.



freq.	std	RF	C/N	BERi	BERo	PER	MER
E38	DVB-T/H	51.0	31.1	4.7E-8	<1E-8	<1E-5	33.7
E40	DVB-T/H	0.0	> 0.0				---
E44	DVB-T/H	0.0	> 0.0				---
E46	DVB-T/H	0.0	> 0.0				---
E49	DVB-T/H	0.0	> 0.0				---
E59	DVB-T/H	0.0	> 0.0				---

To finish, press the home measurement key then on . On this new page, press Prog, select the channel that you want to display.

Check the level, the BER/MER, the TV detection and the spectrum of the signal on this page...



## 2.2.2 Installation of a terrestrial antenna

You have two methods to install a terrestrial antenna :

- Use of the spectrum
- Use of the satellite dish

### 2.2.2.1 Use of the spectrum

Plug the cable of your antenna to the 7849 (take care to use an adequate adaptor)

Turn your appliance on. Press the Measures-TV-Spectrum key



Press the Spectrum zone, access to terrestrial mode if needed

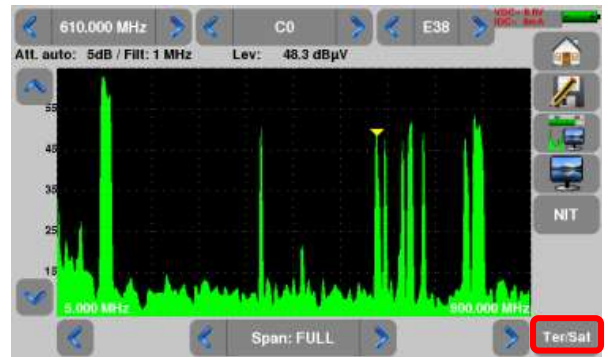

Access to full SPAN mode

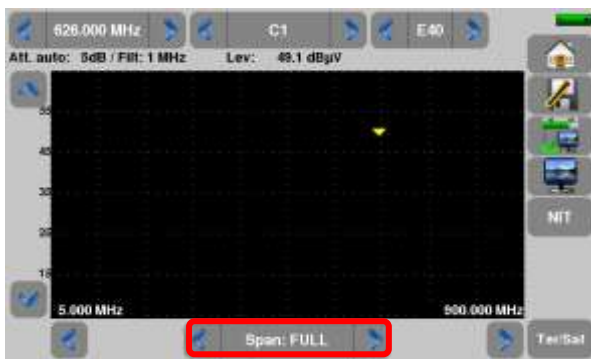

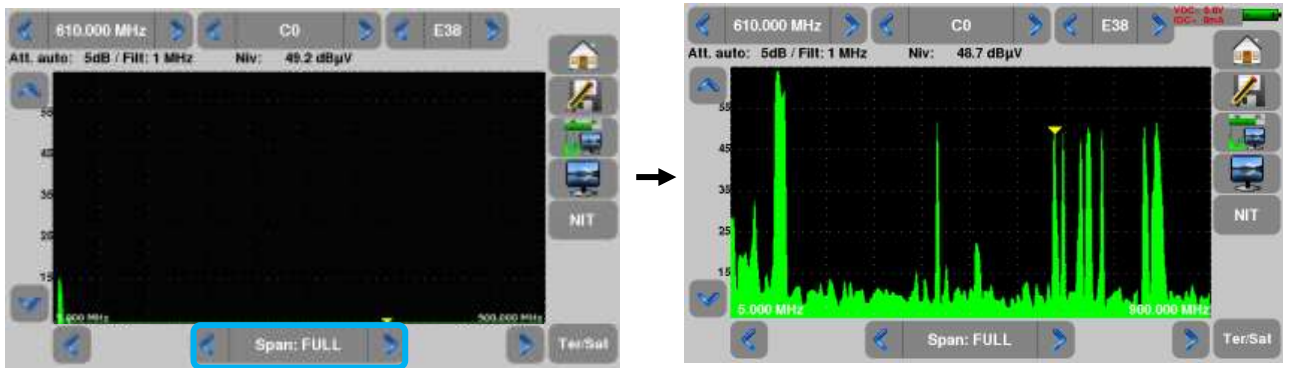

Adjust the antenna to get the most powerful signal possible

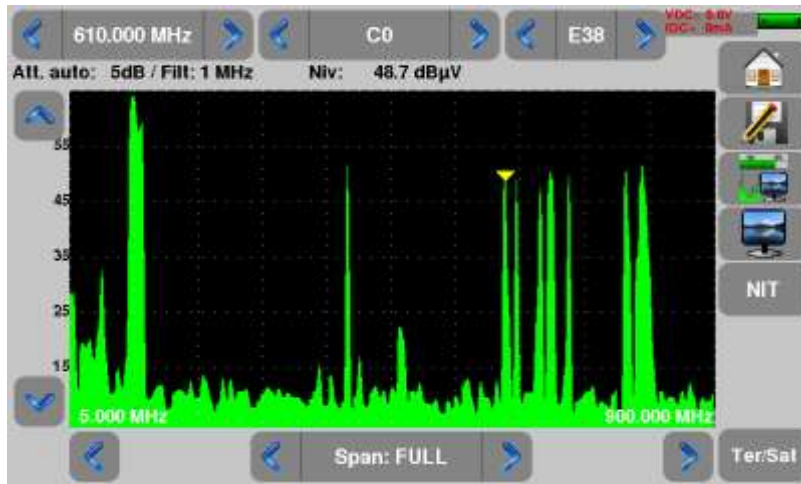

Press directly the signal you want in the spectrum (the cursor moves to where you press)



Press the NIT key , the device find automatically all the parameters of the signal. Once the search ended, the device display the "Network Name" and the "Network ID".

Press the Measures-TV-Spectrum key. You can now display the level, the BER/MER of the signal selected on the same page... 



### 2.2.2.2 Use of the Antenna pointing

The appliance gets an "Antenna pointing" mode in order to align quickly and easily your terrestrial antenna.

To access to the "Antenna pointing" mode from the HOME page, press



The following page appears :

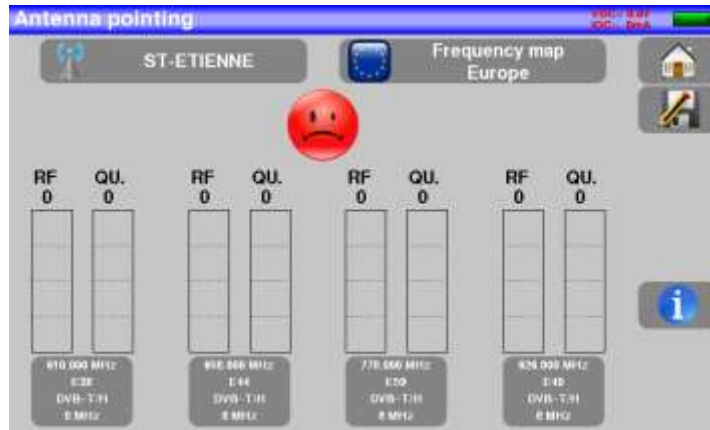

Set your emitter name :

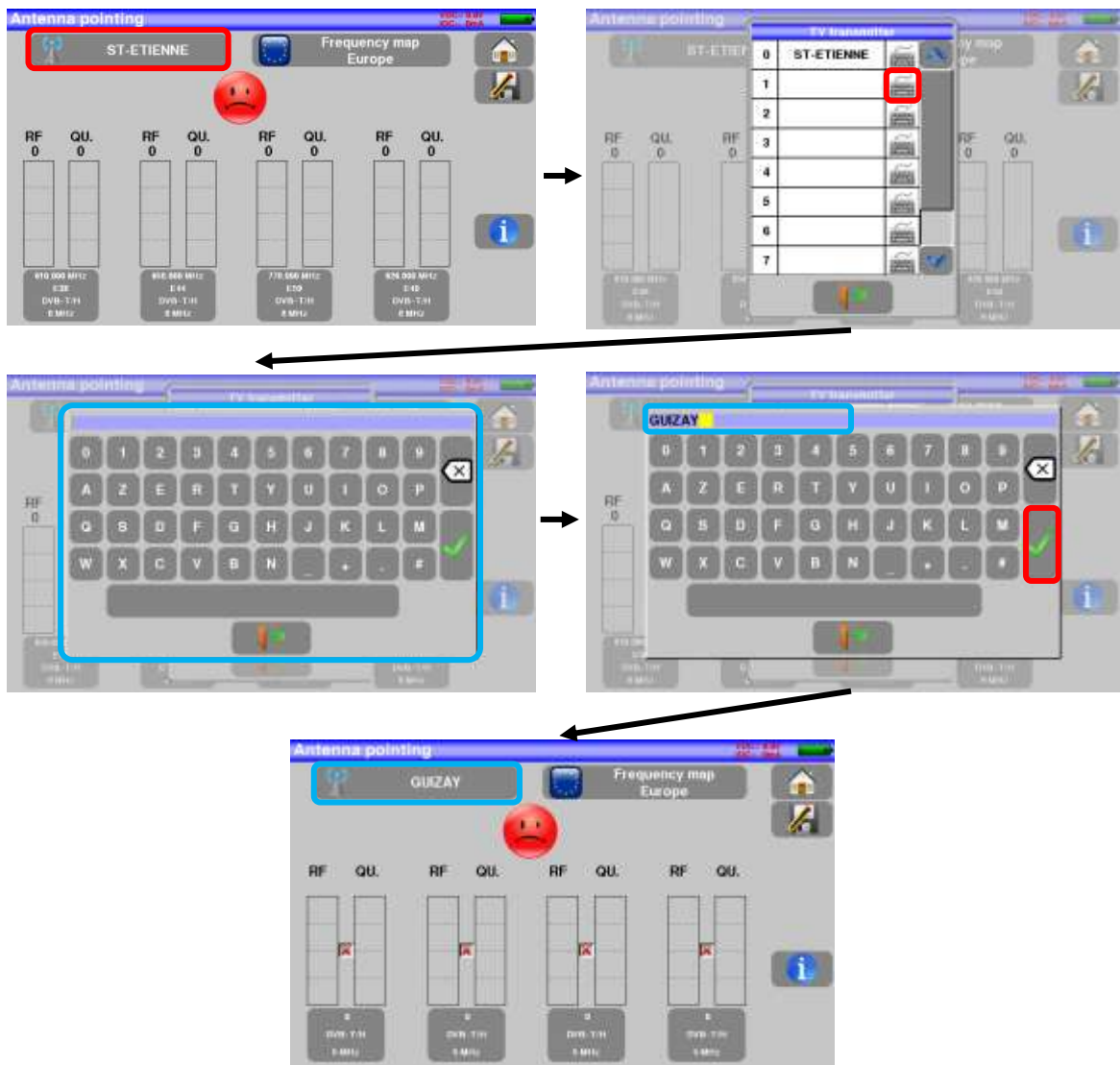



Enter 4 frequencies of the emitter you want to check.



You can find many different French transmitters in an Excel file available on the website of SEFRAM (download section, then database transmitters TNT) or by clicking under the following link:

[http://www.sefram.com/Maj\\_soft/Canaux\\_TNT\\_France\\_2015.xls](http://www.sefram.com/Maj_soft/Canaux_TNT_France_2015.xls)

Slowly orientate the antenna until hearing the locking melody and getting the best quality

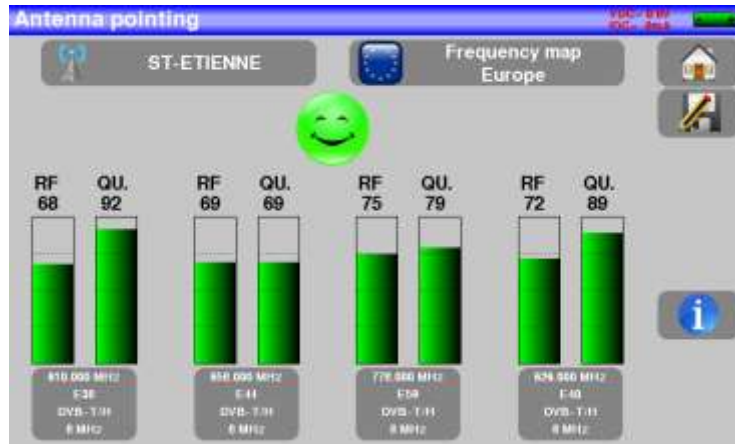

No transmitter found, bad reception quality → red smiley



Average reception quality (< 50%) → orange smiley



Good reception quality (> 50%) → green smiley

## 2.2.3 Installation of a satellite dish

Connect the satellite dish to the appliance.

Activate the remote power supply

To access to the Remote power supply page, press



To switch on the remote power supply, press

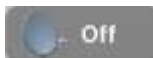

then select **ON** in the page to launch the remote power supply:

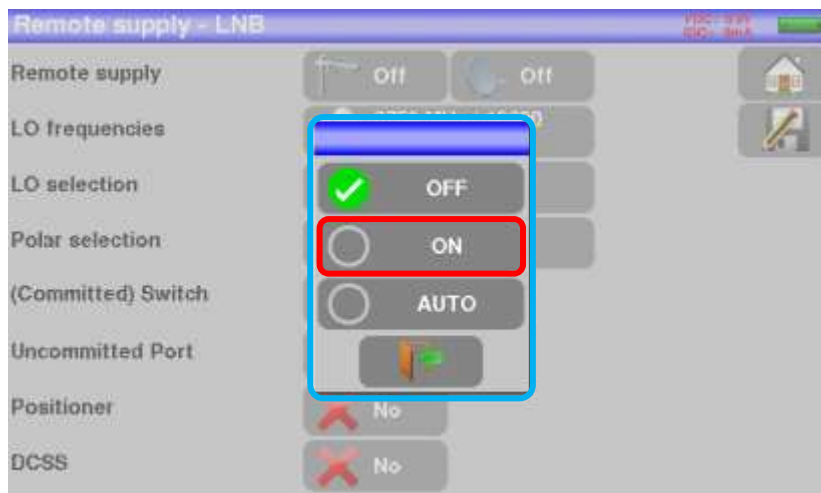

A green check appears in front of what you validated

Press  then  and  access the Check Sat mode.  
(the appliance already includes a list of satellites).

Select a satellite like in the example below (here Astra1):

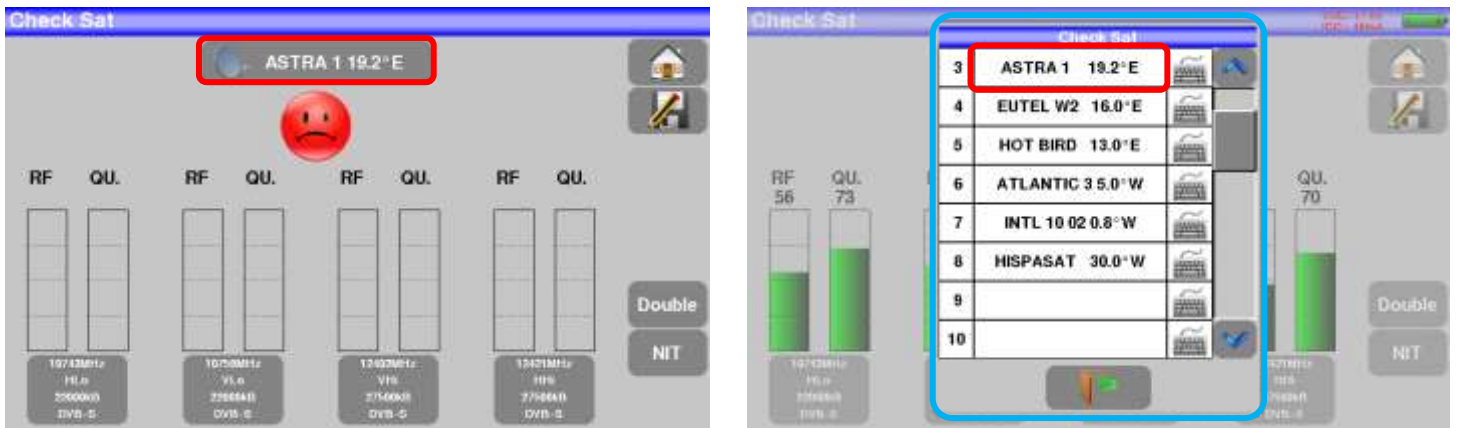

Slowly orientate the satellite dish until hearing the locking melody and getting the best quality



No found transponder → red smiley



Average reception quality (< 50%) → orange smiley



Good reception quality (> 50%) → green smiley

**Reminder** : transponder = satellite channel

To check if the aimed satellite is the right one : press the NIT key

The appliance searches the MPEG NIT table on one of the 4 transponders and displays the name of the satellite:



**Attention:** The displayed name depends on the content of the MPEG NIT table.  
Some distributors provide no (or poor) such table.  
The displayed information may be wrong.



**Attention:**  
To identify a satellite, you must be locked on all 4 transponders. (Quality > 0)  
However, some transponders are regularly modified. See the frequency range of the satellite when a transponder does not seem to work.  
Some switches or LNB work only with DiSEqC commands. In this case, position the band (OL) and the polarization on DiSEqC at the Configuration page LNB-DiSEqC.  
(Attention: the Check Sat is slower when using the DiSEqC command).

## 3 Presentation

### 3.1 General

- The field strength meter **7849** is an appliance designed for the installation and maintenance of any broadcasting and reception installations of analogical and digital terrestrial television channels, satellites or cable networks.

-The band ranges between **5 MHz and 2200 MHz**; this allows accurate measurements on all analogical television standards, FM carrier waves and the various digital standards DVB-C/C2, DVB-T/T2/T2Lite, DVB-S/S2 and DSS.

-He does **Level** measurements in average, peak and power according to the selected standard

-In **Measurement Plan** mode, they scan up to 50 setups at the same time and compare them to decision levels (min / max).

- Equipped with an efficient **Bit Error Rate** measurement (various BER, MER), they allow the full validation of digital transmissions DVB-T/T2/T2Lite, DVB-C/C2, DVB-S/S2 and DSS.

- Providing a **Constellation** diagram for digital standards, the detection and display of **Echoes and pre-echoes** permit to complete this analysis.

- You can display the **digital terrestrial or satellite TV** (free programs) under SD or HD.

- You can hear digital sound through integrated loudspeakers.

-Designed for use on field, it is compact (less than 2 kg battery included), autonomous (battery pack and quick charger), equipped with a LCD 7" touchscreen (capacitive).

- The high memory content allows the storage of many configurations, measurements and spectrum curves.

-**The appliance fully remote-controlled through USB and ETHERNET connections via a computer.**

### 3.2 Description of the appliance

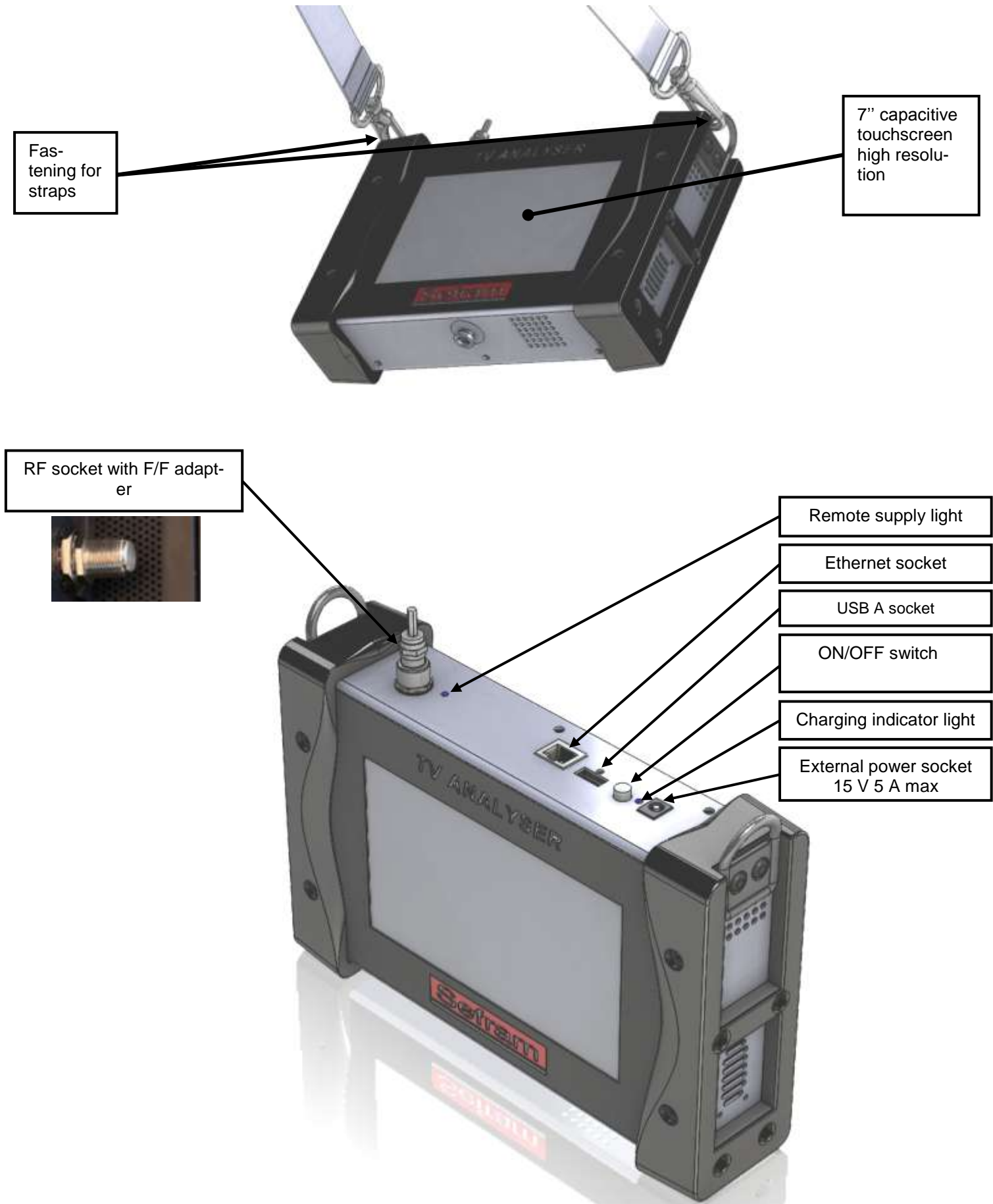

## 4 Power-up

All the material is checked before shipment and delivered in an adapted packaging. There is no particular unpacking instruction.

The appliance is equipped with a Lithium-Ion (Li-ion) battery. It is shipped with the battery loaded.

However, if the appliance has remained idle more than one month long, check its charge state and reload if required.

### 4.1 Battery



**Attention:** Any intervention on the battery requires the disassembly of the appliance and should be made by a SEFRAM technician.  
Use only batteries provided by SEFRAM.

#### **Security advice:**

- Do not throw into the fire or heat up the battery pack
- Do not shunt the parts of the battery: risk of explosion!
- Do not drill
- Do not disassemble the battery pack
- Do not reverse the polarities of the battery
- This battery pack includes a protective item that should not be damaged or removed
- Protect the pack from the heat while storing
- Do not damage the protective sheath of the pack
- Do not store the appliance in a vehicle under sunlight
- Used batteries are not for domestic waste; lithium batteries should be recycled.

***The battery has a 200-charge-discharge cycle life or 2 years.***

#### **Advice to extend the life of your battery:**

- Avoid deep discharges
- Do not store the batteries too long without using them
- Store the battery around 40% loading
- Do not fully charge or fully discharge the battery before storage.

***When the battery is almost fully discharged, the appliance will warn “Low battery”, and then will shut off after a few minutes.***

### 4.2 Battery charge

#### **To charge the battery inside the appliance:**

- Connect the external power supply provided through the jack plug of the appliance (above)
- Connect the power supply on the mains
- The internal charger starts loading the battery; the green lamp lights up.



Charge the device only when the device is off.  
Charge the device only with the provided power supply block.

The battery is 80%-loaded after 1 hour 50 minutes. The total charge is reached after 2 hours 30 minutes.

The autonomy is defined in terrestrial mode with the lighting of the screen decreased, without remote supply, interfaces not connected and sound at 10%

### 4.3 External power supply

The appliance works under 15V (1 A) power supply. The power supply block provided is an external power supply too. Only use the power supply block provided with the appliance. Use of another mains block could damage your appliance and would not valid the guarantee.

### 4.4 Turning the appliance on and off

Press the button on the right side of the appliance:

The entry page appears on screen.

The message “**Autotest: running**” is shortly displayed, and then disappears.

Pressing this button turns the appliance off.



The ON/OFF button **lights up** when the appliance is working.  
Pressing the ON/OFF button for a long time **forces the shut-off** of the appliance; **proceed this way only in case of necessity.**



# 5 Man-machine interface

## 5.1 Content of the screen

7849 is an appliance with a capacitive touchscreen. No glove should be used. If you don't want to damage your screen, do not use any stylus or object.

You can recognize the « keys » by their dark grey frame, example the Home key: 

You can also select lines of tables.

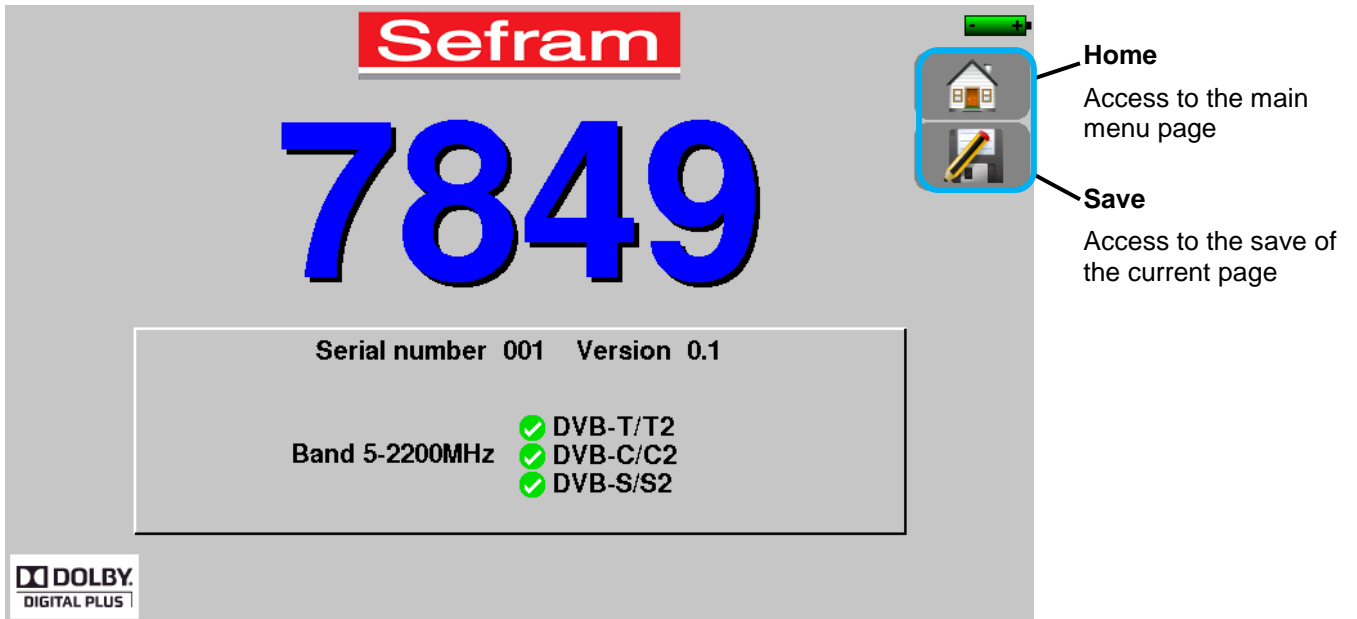

The Home page allows the navigation through all functions of the appliance. You will also find there the [LNB - DiSEqC](#) and [Measures-TV-Spectrum](#) functions, the [AUTOSET](#), [Lists](#), [Library](#), [Check Sat](#), [Configuration](#), [Constellation](#), [Echo Guard Interval](#), [Measurement map](#).



On all pages is displayed the following information:

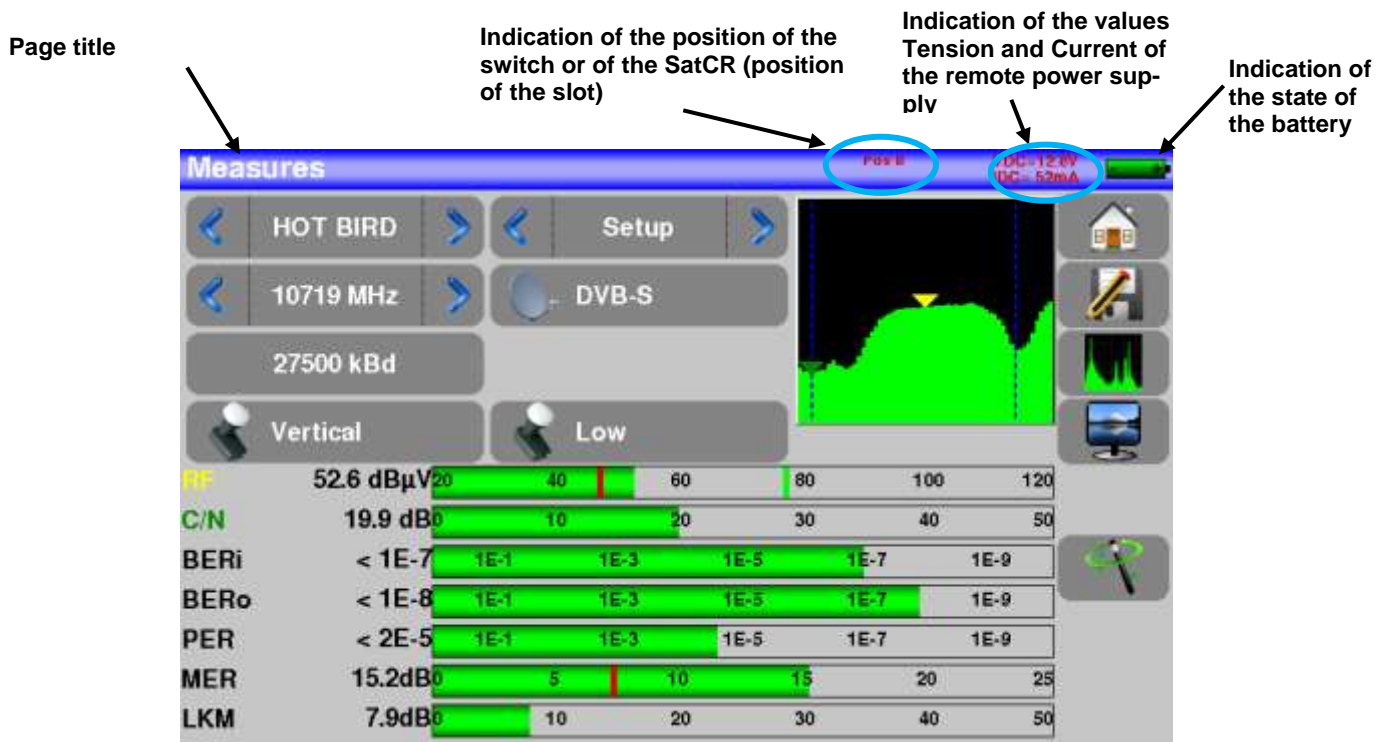

**Attention:** To exit a window like this one below, you have to press the key

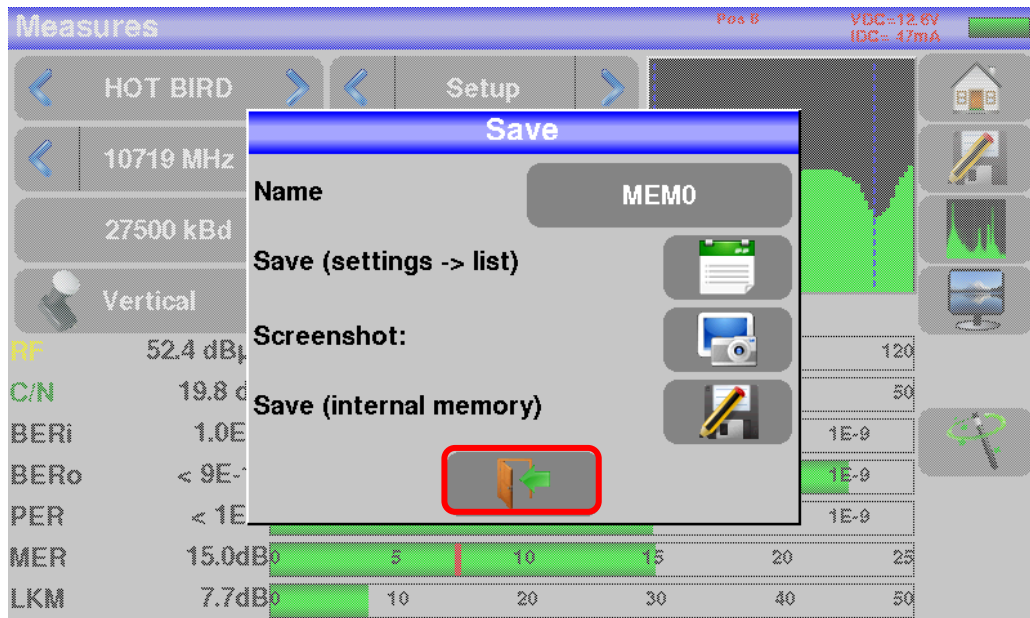

To navigate through a table inside a page or a window, a vertical slide appears with arrows to move up and down the table.

To move faster, you can slide a cursor with your fingers.

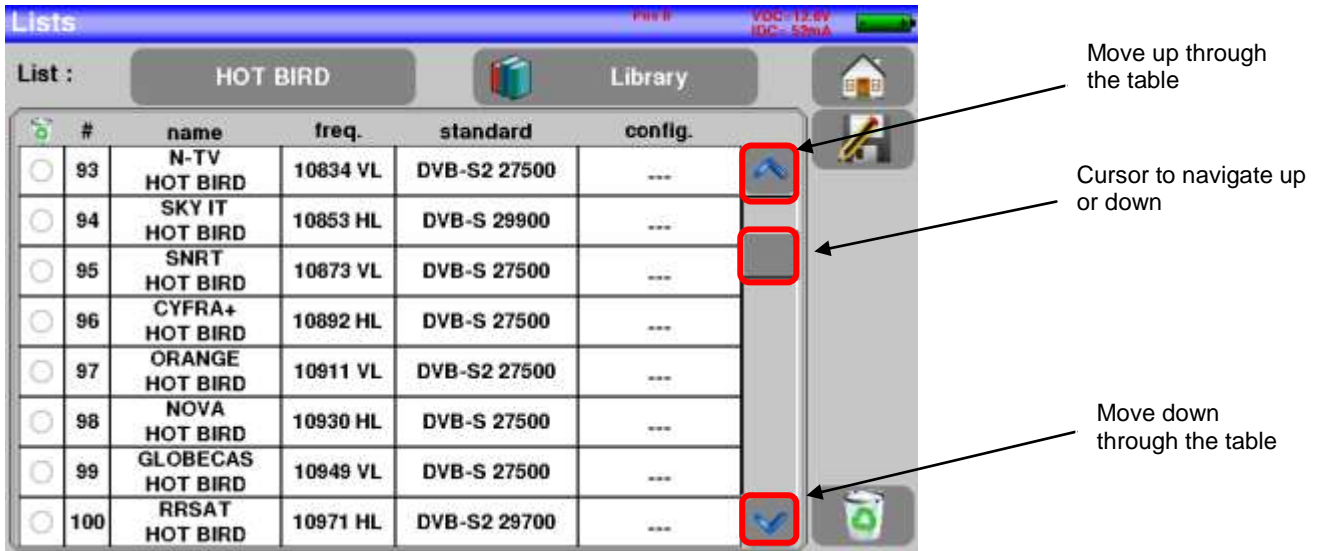

## 5.2 Changing name or value

### 5.2.1 Changing inside a table

You can select a setup in the table. In this case, you can validate a setup by pressing the line you want to display.

In this example, you change from the TNT-R1 setup to the TNT-R4 in the Measure page:

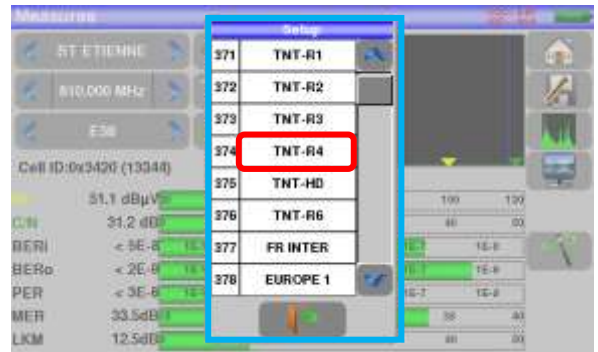

### 5.2.2 Change with selection

When pressing a key, you may have a window with multiple choices. You only have to press the value you want to validate it, the  key allows you to cancel and exit this window, like in the example below:

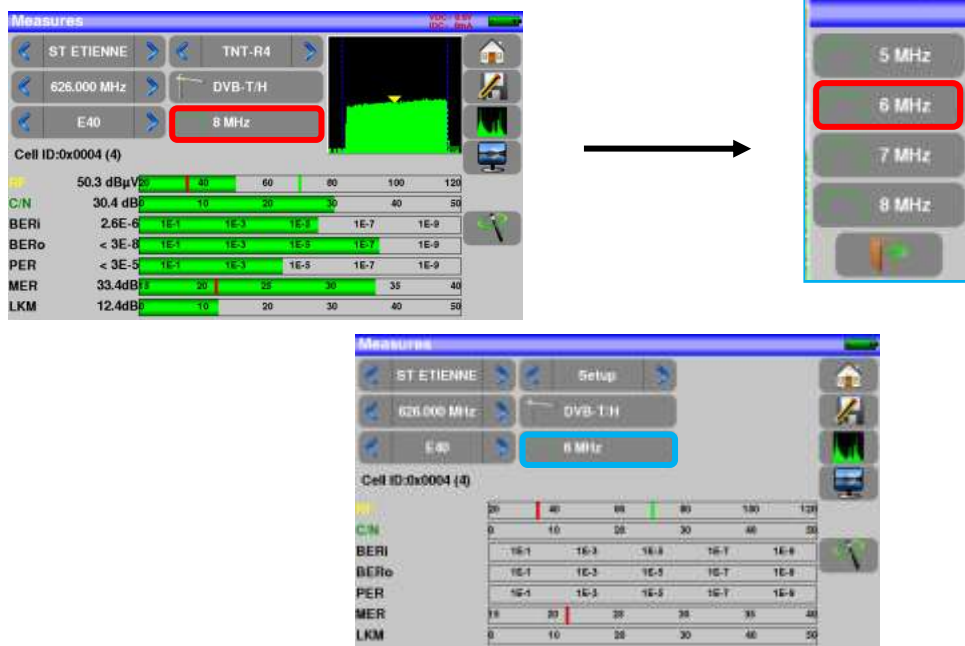

In this example, the bandwidth changes from 8 to 6 MHz:



### 5.2.3 Change with virtual keyboard

If you want to enter a name of a number, a window appears with a numeric keypad and a virtual AZERTY keypad:



In this keyboard appear keys  to erase,  to valid the selected value and the  key to cancel and exit from this window.

### 5.3 Lists of measurements and setup library

In order to make easier the recall of data on field, the appliance uses 20 measurement lists of each 50 lines and 1000 setups.

A setup corresponds to a terrestrial, cable or satellite emission.

A list of measurements corresponds to a particular installation: presence of several satellite dishes, of various switches...

**Example of list** (the background of the table is white)

#	name	freq	standard	config
371	TNT-R1 ST-ETIENNE	E38	DVB-T/H 8M GI auto	---
372	TNT-R2 ST-ETIENNE	E44	DVB-T/H 8M GI auto	---
373	TNT-R3 ST-ETIENNE	E59	DVB-T/H 8M GI auto	---
374	TNT-R4 ST-ETIENNE	E40	DVB-T/H 8M GI auto	---
375	TNT-HD ST-ETIENNE	E49	DVB-T/H 8M GI auto	---
376	TNT-R6 ST-ETIENNE	E46	DVB-T/H 8M GI auto	---
377	FR INTER ST-ETIENNE	88.000	FM	---
378	EUROPE 1 ST-ETIENNE	104.800	FM	---

**Example of library** (the background of the table is yellow)

#	name	freq	standard
0	DIGITAL+ ASTRA 1	10728 VL	DVB-S2 22000
1	ARD ASTRA 1	10743 HL	DVB-S 22000
2	ANIXE HD ASTRA 1	10773 HL	DVB-S2 22000
3	DIGITAL+ ASTRA 1	10788 VL	DVB-S 22000
4	DIGITAL+ ASTRA 1	10817 VL	DVB-S2 22000
5	HD+ ASTRA 1	10832 HL	DVB-S2 22000
6	DIGITAL+ ASTRA 1	10847 VL	DVB-S 22000
7	TVP HD ASTRA 1	10861 HL	DVB-S 22000

The same setup may be used in several measurement lists.

The same installation may use two satellite dishes

ASTRA 19.2 in DiSEqC position A

HOT BIRD 13 in DiSEqC position B

Another one may use three satellite dishes

ATLANTIC BIRD 3 in DiSEqC position A

ASTRA 1 in DiSEqC position B

HOT BIRD in DiSEqC position C

The same setup may be used several times in the same measurement list.

ZDF SatCR slot 0

ZDF SatCR slot 1

ZDF SatCR slot 2

ZDF SatCR slot 3...

If a parameter of a setup changes, for example a modification of rate or change from DVB-S to DVB-S2, only the setup inside the library should be updated.

A list of measurements is made of:

- a list name in 10 characters
- the lowest frequency of the LNB (OL1)
- the highest frequency of the LNB (OL2)
- the selection mode low band / high band of the LNB
- the selection mode of the polarization
- the presence of the position number of the positioner (motorized satellite dish)
- 50 lines including each:
  - a setup number corresponding to the setup list
  - the presence and the functioning mode of the switch, committed type
  - the position of the switch, committed type
  - the presence and the functioning mode of the switch, uncommitted type
  - the position of the switch, uncommitted type
  - the presence of SatCR equipment
  - the SatCR slot number
  - the position of the SatCR switch

A few of these parameters are specific to the waveband of the satellite and have no influence in terrestrial and cable modes.

A setup is made of:



- a setup name in 8 characters
- a place name in 10 characters
- a frequency
- a channel number in terrestrial or cable mode
- a frequency map in terrestrial or cable mode
- a vertical or horizontal polarization in satellite mode
- a low or high LNB band in satellite mode
- a standard
- an analogical mono stereo or NICAM mode in terrestrial or cable mode
- a constellation type 64QAM 256QAM under DVB-C
- a bandwidth 5, 6, 7 or 8 MHz under DVB-T and DVB-T2
- a symbol rate under DVB-C, DVB-S, DVB-S2 or DSS

According to the terrestrial, cable or satellite band mode and to the standard, some parameters have no influence.

The place name may distinguish two distinct emitters, example TF1 Fourvière and TF1 Chambéry.

Frequency and channel number are equivalent: a valid channel number has priority over a frequency.

The frequency map parameter associated with the setup allows frontiersmen to keep on using channel numbers.

	Selecting a list in the <b>Lists</b> page automatically recalls all information associated with this list.
	Selecting a <b>Setup</b> on a measurement page automatically recalls all information associated with this setup.

## 6 AUTASET mode



**Attention:** The Autoset channel research is only possible when at least one list is empty with enough place in the library

This mode allows an **automatic research of setups** and to provide information about the current place.

You can access it through the key  on page Home.

The displayed lines on this page depend on the selected **Frequency band**. The key before the Mode line allows you to select between terrestrial, cable or satellite mode:

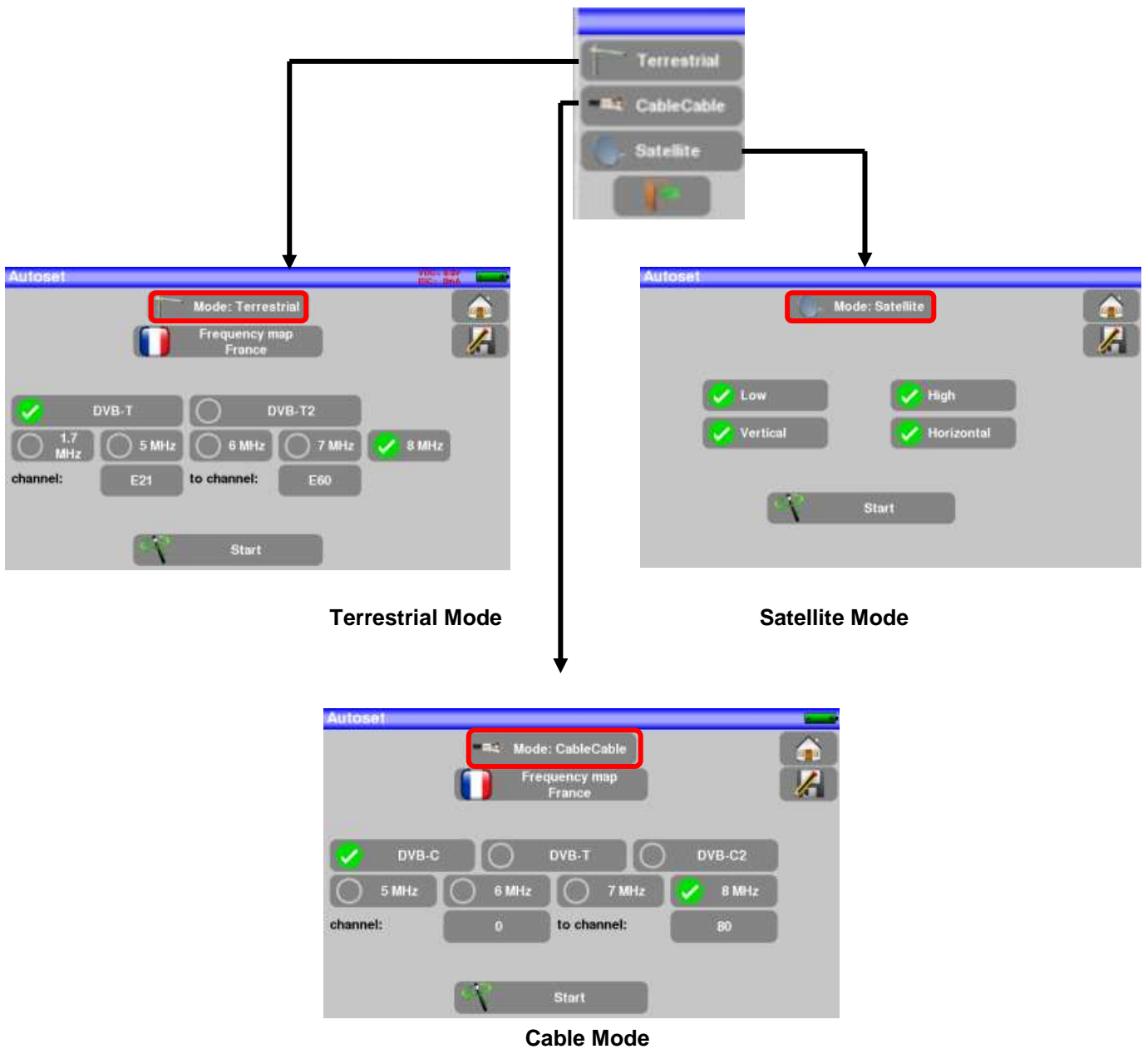

Once the mode selected, the keys of the various parameters activate or deactivate each option.

A green check shows that the parameter is included in the research. If there is no green check, the parameter will not be taken into account for the research.

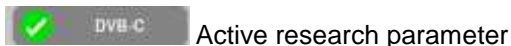

	<b>Attention:</b> The more you select options, the longer is the research.
---	--

## 6.1 Terrestrial mode

This mode allows automatic research on the **terrestrial** frequency band.

The table allows the selection of:

- Standards
- Channel widths
- The channel range of the research (i.e. 21 to 60).

The goal is to make researches shorter by defining at best the settings (example: in France, no DVB-T2, band width DDT 8MHz first channel 21, last channel 60)



## 6.2 Satellite mode

This mode allows automatic research on the **satellite** frequency band.

The table allows the selection of:

- LNB bands
- LNB polarisations.

The goal is to make researches shorter again





### 6.3 Cable Mode

This mode allows automatic research on the **cable** frequency band.

The table allows the selection of:

- Standards
- Channel widths
- The search range of channels



### 6.4 «START » menu key

No matter which mode is selected, press the “**START**” key when the table is filled to launch the research. Pressing “**Stop**” will abort the research.

When the research is done or if the user aborted it, the appliance turns automatically to the **Measurement map** function.

freq.	std	RF	C/N	BERi	BERo	PER	MER
E38	DVB-T/H	51.0	31.1	4.7E-8	<1E-8	<1E-5	33.7
E40	DVB-T/H	0.0	> 0.0				...
E44	DVB-T/H	0.0	> 0.0				...
E46	DVB-T/H	0.0	> 0.0				...
E49	DVB-T/H	0.0	> 0.0				...
E59	DVB-T/H	0.0	> 0.0				...

Any detected channel will be registered into the first empty list (automatically renamed AUTOSSET) and into the first available setups of the library, starting from the end of the table.

#	name	freq.	standard	config.
380	C0 Autoset	E38	DVB-T/H 8M GI auto	---
381	C1 Autoset	E40	DVB-T/H 8M GI auto	---
382	C2 Autoset	E44	DVB-T/H 8M GI auto	---
383	C3 Autoset	E46	DVB-T/H 8M GI auto	---
384	C4 Autoset	E49	DVB-T/H 8M GI auto	---
385	C5 Autoset	E59	DVB-T/H 8M GI auto	---

#	name
5	ASTRA 2
6	TURKSAT
7	AST1 SATCR
8	ST ETIENNE
9	AST+ST-ET
10	AUTOSSET
11	---
12	---

#	name	freq.	standard
379	FR MUSIQ ST-ETIENNE	97.100	FM
380	C0 Autoset	E38	DVB-T/H 8M GI auto
381	C1 Autoset	E40	DVB-T/H 8M GI auto
382	C2 Autoset	E44	DVB-T/H 8M GI auto
383	C3 Autoset	E46	DVB-T/H 8M GI auto
384	C4 Autoset	E49	DVB-T/H 8M GI auto
385	C5 Autoset	E59	DVB-T/H 8M GI auto
386	---	---	---

The new list is created in the first available list

The default name of the new list is AUTOSSET

New found channels are added one by one into the new list

New found channels are added one by one into the first available setups of the library, starting from the end of the table

# 7 Measurement lists

## 7.1 The list page

In this page, you can select the list where you will work on measurements.

Pressing Home  then Lists-Library  gives you access to the **Lists** function:

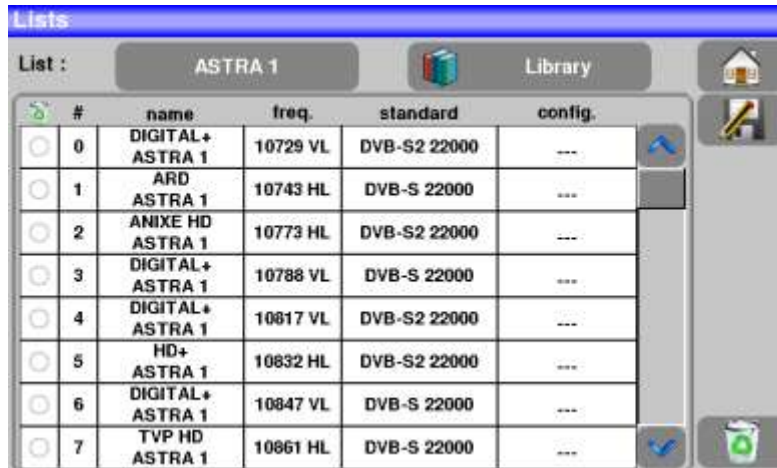

#	name	freq.	standard	config.
0	DIGITAL+ ASTRA 1	10729 VL	DVB-S2 22000	---
1	ARD ASTRA 1	10743 HL	DVB-S 22000	---
2	ANIXE HD ASTRA 1	10773 HL	DVB-S2 22000	---
3	DIGITAL+ ASTRA 1	10788 VL	DVB-S 22000	---
4	DIGITAL+ ASTRA 1	10817 VL	DVB-S2 22000	---
5	HD+ ASTRA 1	10832 HL	DVB-S2 22000	---
6	DIGITAL+ ASTRA 1	10847 VL	DVB-S 22000	---
7	TVP HD ASTRA 1	10861 HL	DVB-S 22000	---

Lists are ranked from 0 to 19. To select the one you want, press the following key. Lists are displayed. Press the one you want:

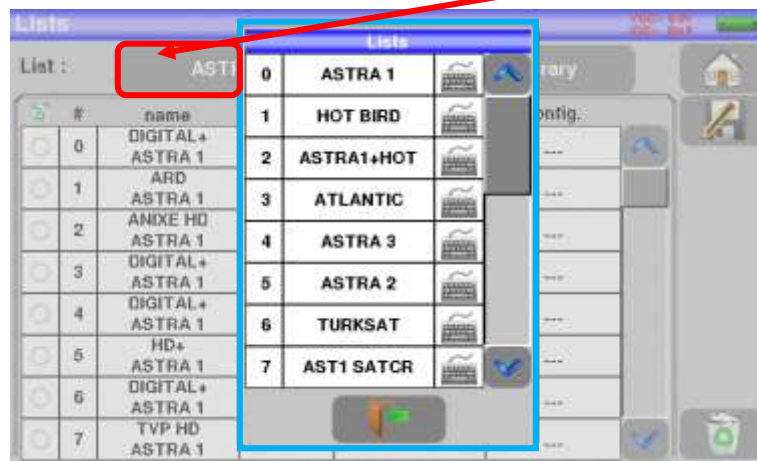

#	name	freq.	standard	config.
0	ASTRA 1			
1	HOT BIRD			
2	ASTRA1+HOT			
3	ATLANTIC			
4	ASTRA 3			
5	ASTRA 2			
6	TURKSAT			
7	AST1 SATCR			

In this example, we selected ST ETIENNE.



#	name	freq.	standard	config.
6	TURKSAT			
7	AST1 SATCR			
8	ST ETIENNE			
9	AST+ST-ET			
10	AUTOSET			
11				
12				
13				



#	name	freq.	standard	config.
371	TNT-R1 ST-ETIENNE	E38	DVB-T/H 8M GI auto	---
372	TNT-R2 ST-ETIENNE	E44	DVB-T/H 8M GI auto	---
373	TNT-R3 ST-ETIENNE	E58	DVB-T/H 8M GI auto	---
374	TNT-R4 ST-ETIENNE	E40	DVB-T/H 8M GI auto	---
375	TNT-HD ST-ETIENNE	E48	DVB-T/H 8M GI auto	---
376	TNT-R6 ST-ETIENNE	E46	DVB-T/H 8M GI auto	---
377	FR INTER ST-ETIENNE	88.000	FM	---



**Attention:** A list may contain a Satellite and a Terrestrial setup.

## 7.2 Modification of a list

To change the name of the list of ST ETIENNE, you must push on its name, then on the symbol of the keypad. A virtual keypad shows up. Type the new name (SEFRAM in our example).

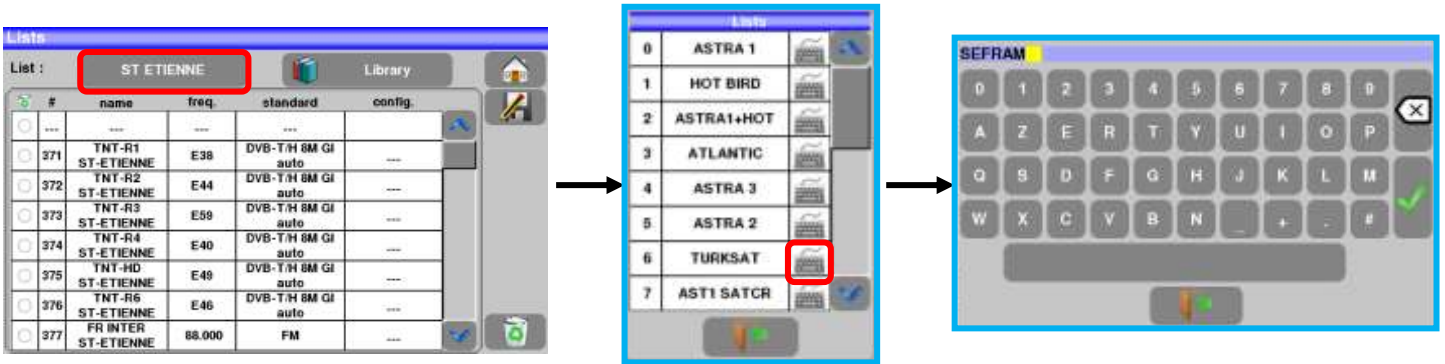

To add a setup to the list, select the line. A window shows up:

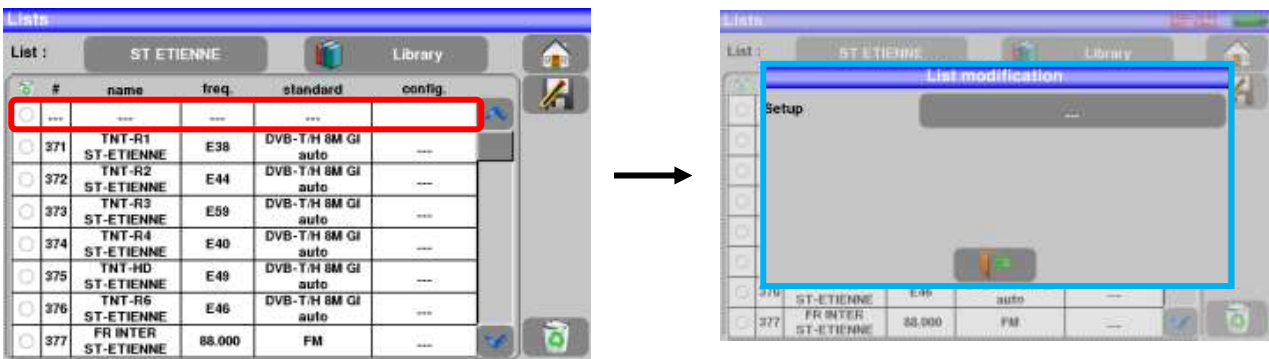



**Attention:** If the line contains a setup, it shall be erased. To cancel, press: 

By pressing the key before Setup, you disclose the available setups from the library (you cannot create a setup from a list; to create a setup, see [Setup creation or modification in the library](#)):

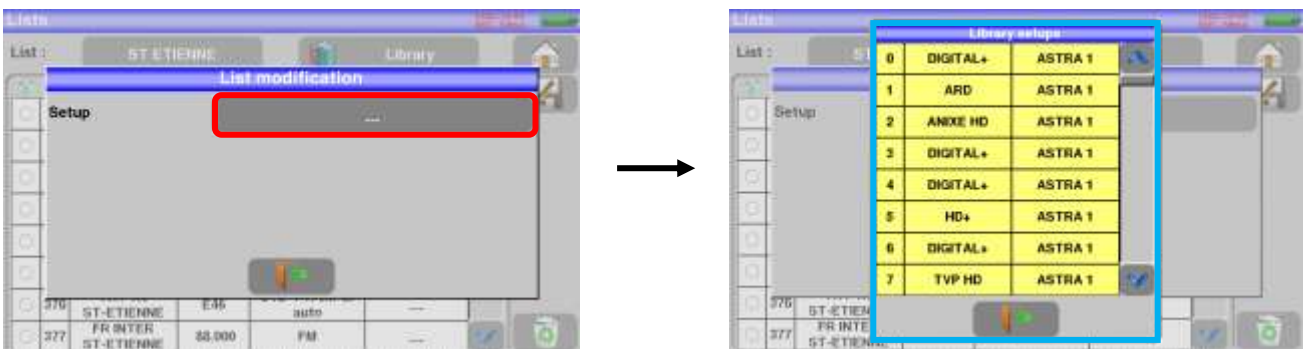

Scroll the list up or down to find the setup you want to add to your list. Press the line you want:

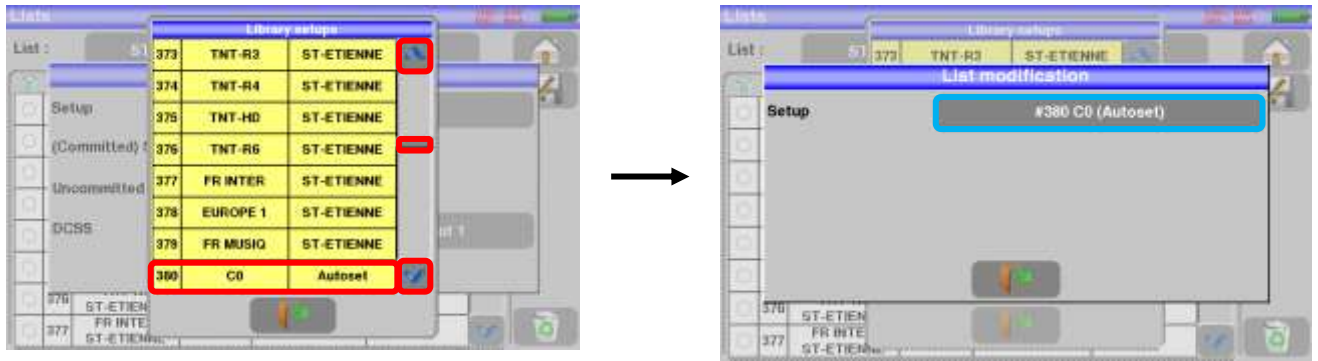



The setup is now in the list:

#	name	freq.	standard	config.
380	C0 Autoset	E38	DVB-T/H 8M Gi auto	---
371	TNT-R1 ST-ETIENNE	E38	DVB-T/H 8M Gi auto	---
372	TNT-R2 ST-ETIENNE	E44	DVB-T/H 8M Gi auto	---
373	TNT-R3 ST-ETIENNE	E58	DVB-T/H 8M Gi auto	---
374	TNT-R4 ST-ETIENNE	E40	DVB-T/H 8M Gi auto	---
375	TNT-HD ST-ETIENNE	E48	DVB-T/H 8M Gi auto	---
376	TNT-R6 ST-ETIENNE	E46	DVB-T/H 8M Gi auto	---
377	FR INTER ST-ETIENNE	88.000	FM	---

You may erase the setup from the list by pressing the check to the left of the setup or to the setups you have to delete. Then click the basket  and select the deletion of the selected setup:



#	name	freq.	standard	config.
---	---	---	---	---
371	TNT-R1 ST-ETIENNE	E38	DVB-T/H 8M Gi auto	---
372	TNT-R2 ST-ETIENNE	E44	DVB-T/H 8M Gi auto	---
373	TNT-R3 ST-ETIENNE	E58	DVB-T/H 8M Gi auto	---
374	TNT-R4 ST-ETIENNE	E40	DVB-T/H 8M Gi auto	---
375	TNT-HD ST-ETIENNE	E48	DVB-T/H 8M Gi auto	---
376	TNT-R6 ST-ETIENNE	E46	DVB-T/H 8M Gi auto	---
377	FR INTER ST-ETIENNE	88.000	FM	---

You can also delete the totality of a list by pressing directly on the basket  then by selecting .

In a satellite setup, you can change the switch, the Uncommitted Port and the DCSS by activating any of these keys (this change will affect only the setup in this list, not in the library):

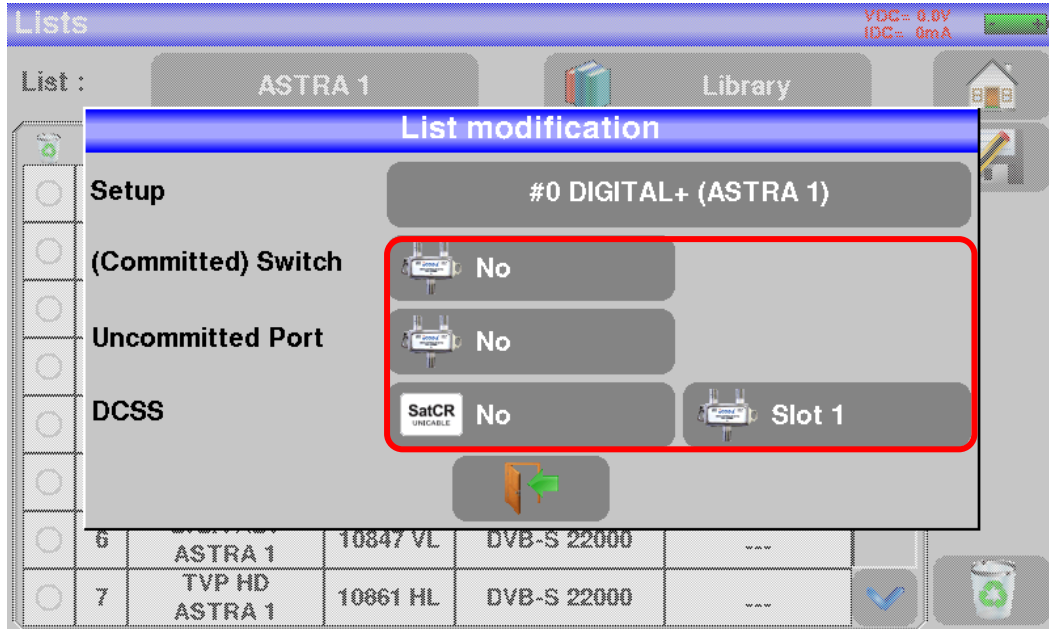

## 8 Setup library

### 8.1 The library page

By pressing Home  then Lists-Library , you can access the Lists function.

From there, you can access the Library by pressing the key .

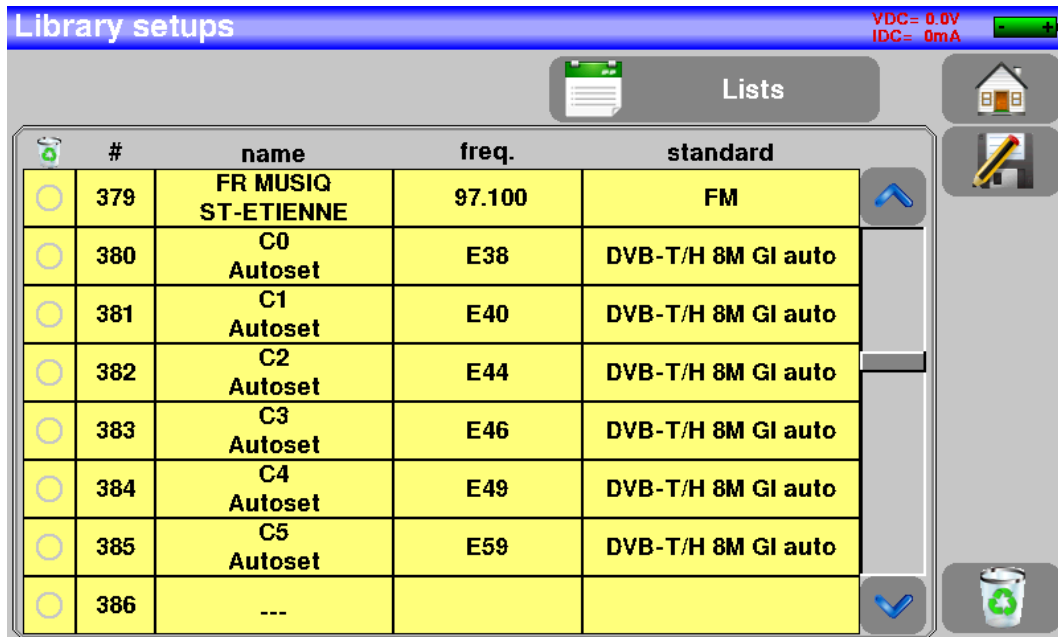

#	name	freq.	standard
379	FR MUSIQ ST-ETIENNE	97.100	FM
380	C0 Autoset	E38	DVB-T/H 8M GI auto
381	C1 Autoset	E40	DVB-T/H 8M GI auto
382	C2 Autoset	E44	DVB-T/H 8M GI auto
383	C3 Autoset	E46	DVB-T/H 8M GI auto
384	C4 Autoset	E49	DVB-T/H 8M GI auto
385	C5 Autoset	E59	DVB-T/H 8M GI auto
386	---		

### 8.2 Creation or modification of setups in the library

To create or change a setup in the library, you have to select a line in the table. A window pops up:



**Attention:** If the line contains a setup, it will be erased. To cancel, press: 



#	name	freq.	standard
368	---		
369	---		
370	---		
371	TNT-R1 ST-ETIENNE	E38	DVB-T/H 8M GI auto
372	TNT-R2 ST-ETIENNE	E44	DVB-T/H 8M GI auto
373	TNT-R3 ST-ETIENNE	E59	DVB-T/H 8M GI auto
374	TNT-R4 ST-ETIENNE	E40	DVB-T/H 8M GI auto
375	TNT-HD ST-ETIENNE	E49	DVB-T/H 8M GI auto



Name	370
Satellite	---
Frequency	10729 MHz
Standard	DVB-S2
Polar./Band	Low Vertical
Symbol rate	22000 kBd

You may erase the setup from the list by pressing the check to the left of the setup or to the setups you have to delete. Then click the basket  and select the deletion of the selected setup:

From this window, you can create a terrestrial, satellite KU, L or C setup.

To proceed, see chapter 5 [Man-machine interface](#)

➤ **Terrestrial setup:**

**Under standard DVB-T/H DVB-T2**

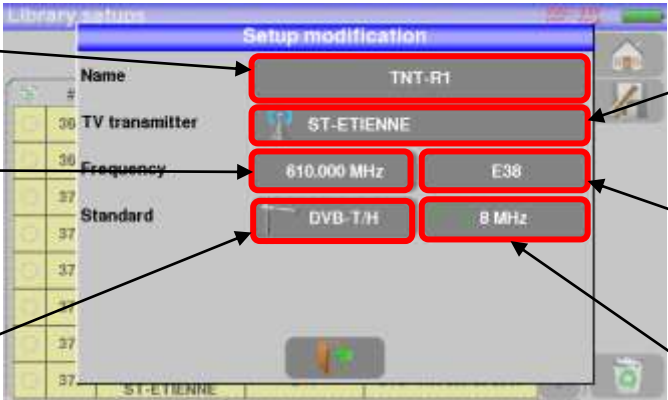

To enter the name you want for the setup

To enter the frequency you want for the setup

To enter the standard you want for the setup (DVB-T/H in this case)

To enter the Emitter/Satellite name you want for the setup

To enter the channel you want for the setup

To enter the frequency band you want for the setup

**Under standard DVB-C / DVB-C2**

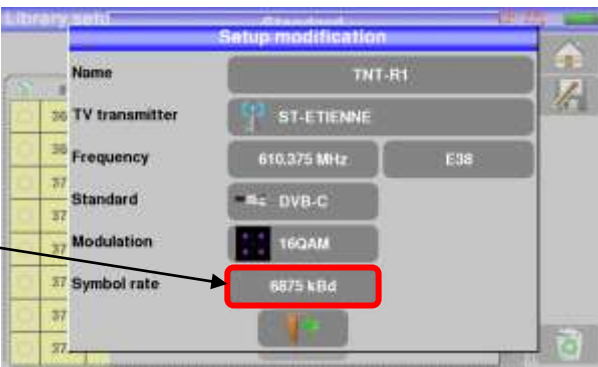

To enter the symbol rate you want for the setup

**In terrestrial analogical standard (L, BG, DK, I and MN)**

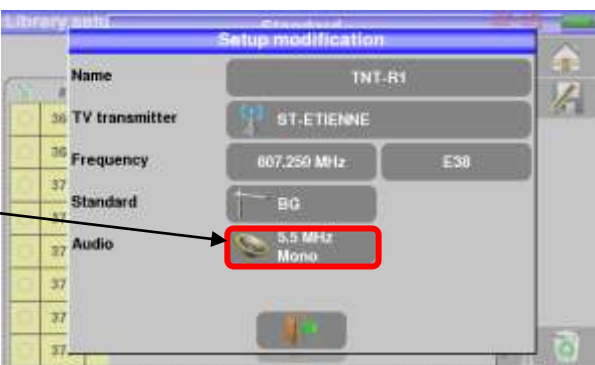

To enter the type of audio configuration you want for the setup (mono, stereo or NICAM)



➤ **Setup Satellite KU, L or C:**

Ku L or C corresponds to the selected band

To enter the type of polarity you want for the setup (high or low, vertical or horizontal)

To enter the symbol rate you want for the setup

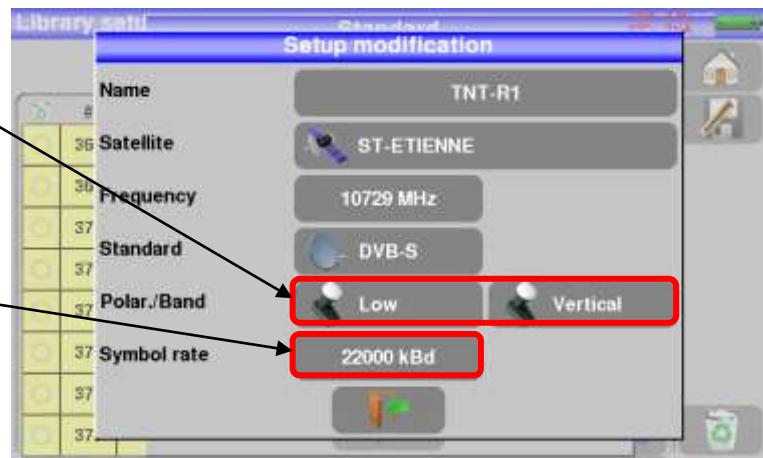

# 9 Check Sat

Press  and  to access the Check Sat mode.

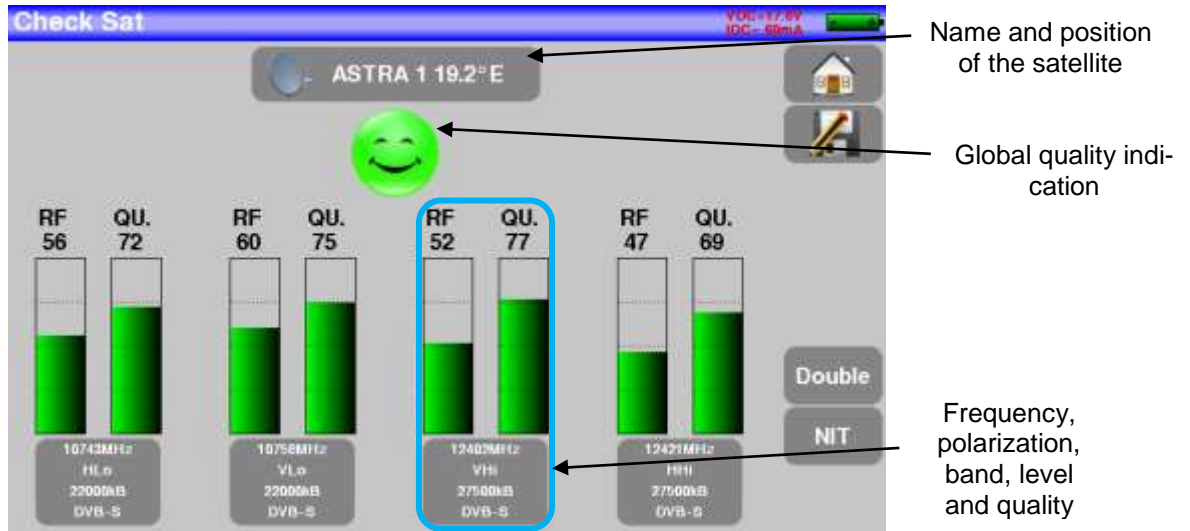

The appliance has 32 possible orbital positions for satellites. It is provided with near of 10 satellites registered.

4 transponders are appended to each satellite.

You can select the satellite by pressing « Name and position of the satellite ».

To modify a transponder, you must press the corresponding key:

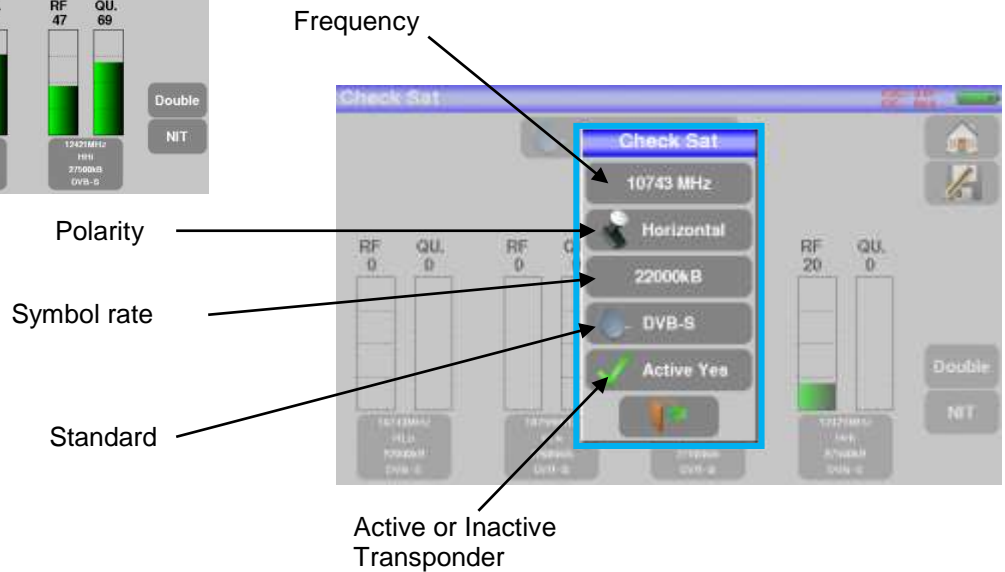

## 9.1 Updating satellites

You can update frequencies of the checks sat by consulting the file PDF posted on-line on the site web of SEFRAM. .

You have to modify frequencies, following the previous paragraph and using the file updated monthly on the web site of SEFRAM. [http://www.sefram.fr/www/PDF\\_FR/Sat\\_PDF.pdf](http://www.sefram.fr/www/PDF_FR/Sat_PDF.pdf)

We advise you to check and to update your frequencies every three months. We advise you to check and to update your frequencies every three months

## 9.2 Check Sat function

### Procedure:

1/ Connect the satellite dish to the appliance and start it up.

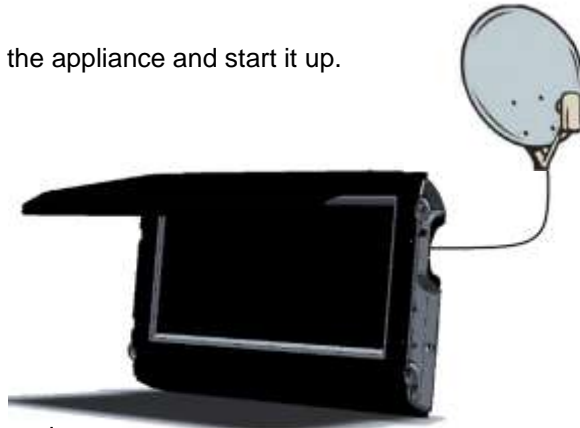

2/ Validate the remote power supply:

- VDC lights up.
- Check the power supply current of the LNB (IDC at the top right corner of the screen should be between 50 and 200 mA).

See chapter [Remote power supply / LNB – DiSEqC](#)

3/ On the Home page, go to the Check Sat mode.

Select the satellite to aim at in the list (example ASTRA1)

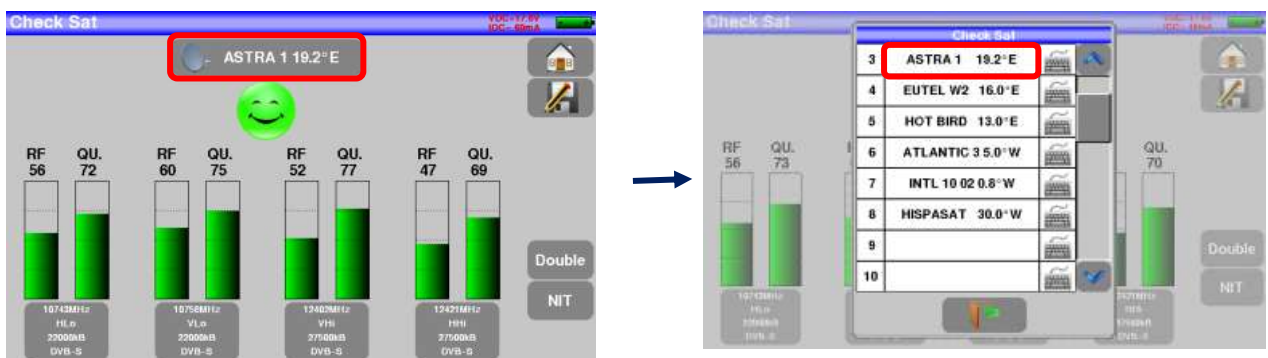

4/ Slowly orientate the satellite dish until hearing the locking melody and getting the best quality.

5/ Slightly turn the LNB to get the best quality (counter-polarization).

You will hear a melody as soon as a first transponder is detected; then, you will hear beeps. These beeps are closer and closer as the quality increases.



If the appliance is not synchronized on all four transponders, the quality indication is **red**.



If the appliance is synchronized on all four transponders but the reception quality is average, the quality indication is **orange**.



Good reception quality (> 50%) → green smiley





	<p><b>Attention:</b></p> <p>To identify a satellite, it must be synchronized on all <b>4 transponders</b>.</p> <p>However, some transponders are regularly modified. See the frequency map of the satellite if a transponder does not seem to work.</p> <p>Some switches or LNB work only with DiSEqC commands. In this case, position the OL and the polarization on DiSEqC in the Configuration page LNB-DiSEqC. (Attention: the Check Sat is slower with DiSEqC commands).</p>
---	---

### 9.3 Checking the aligned satellite

To check if you have aimed the right satellite, press the NIT key.

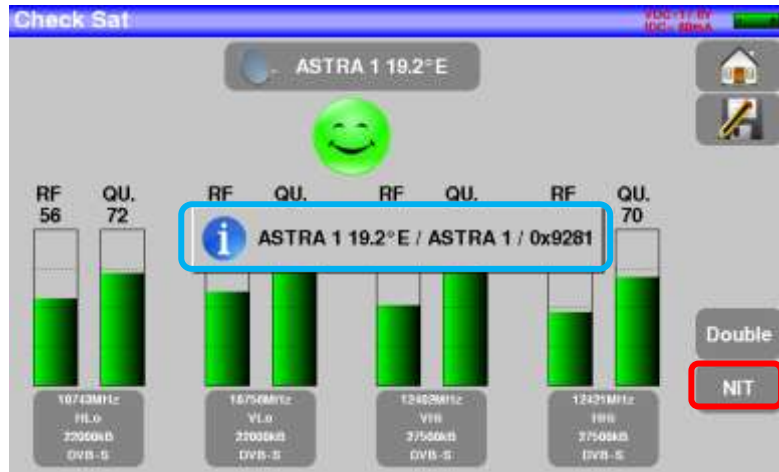
The appliance searches the MPEG NIT table on one of the 4 transponders and displays the name of the satellite:





**Attention:** The displayed name depends on the content of the MPEG NIT table. Some distributors provide no (or poor) such table. The displayed information may be wrong.

### 9.4 Double Check Sat

This mode allows you to orientate a double LNB by checking 4 transponders on 2 selected satellites. This mode is identical to the simple Check Sat mode.

To access the double Check Sat mode, you have to trigger the Double key.

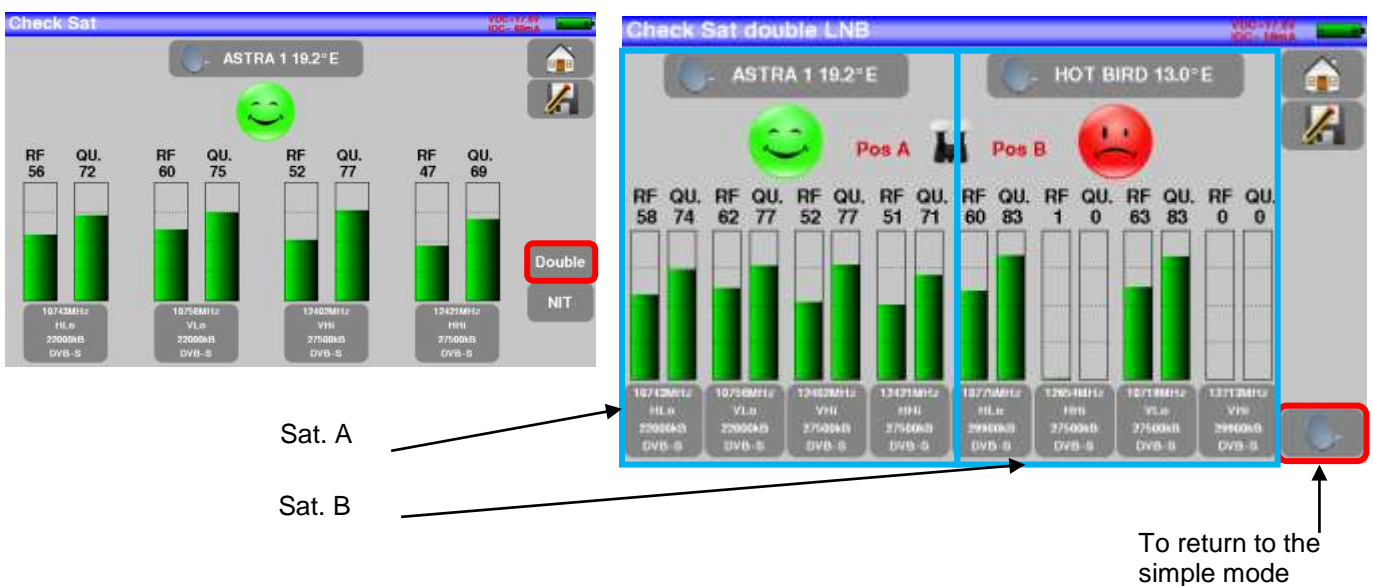

Sat. A

Sat. B

To return to the simple mode

### 9.4.1 Recall

#### Azimuth

Position of the satellite dish on the horizontal plane with reference to the north. Measured in degrees.



#### Elevation

Tilt angle under which the beam from the satellite reaches your antenna. Measured in degrees using what is specified on the stand of the satellite dish.

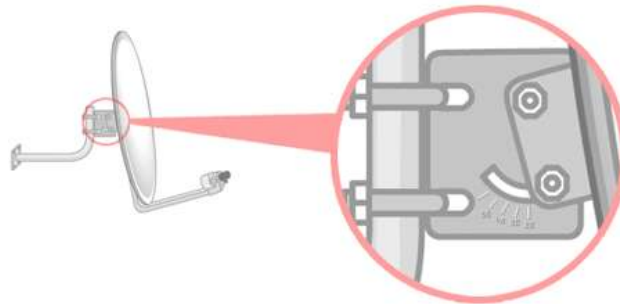

#### Polarization

Rotation required for the LNB from a vertical line. Measured in degrees.

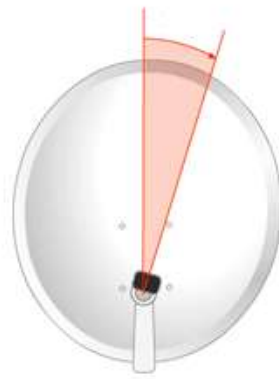

# 10 TERRESTRIAL check

To access to the menu terrestrial check from Home page, press

The following page appears:

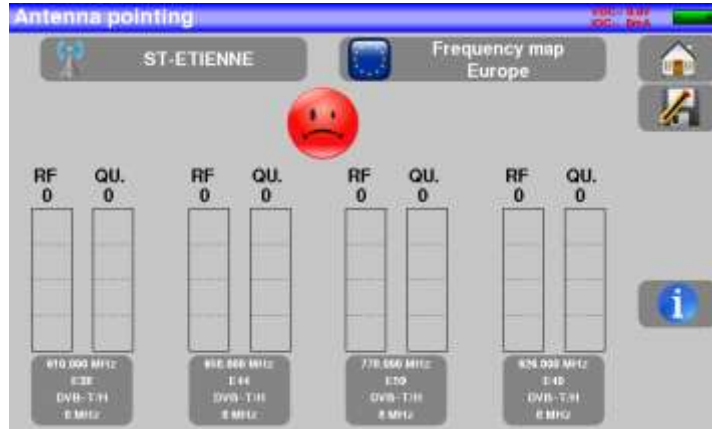

Set up your check:

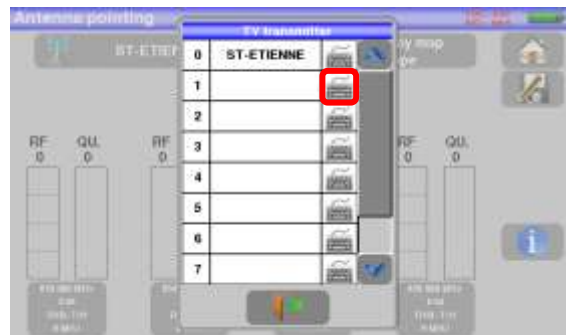

Enter 4 frequencies or channels of the transmitter you try to check.



 You can find the numbers of transponders of different French transmitters in an Excel file available on the website of SEFRAM (download section, then database transmitters DDT) or by clicking under the following link:  
[http://www.sefram.com/Maj\\_soft/Canaux\\_TNT\\_France\\_2015.xls](http://www.sefram.com/Maj_soft/Canaux_TNT_France_2015.xls)

Once you informed the 4 transponders, slowly orientate the satellite dish until hearing the locking melody and getting the best quality.







No found transponder → red smiley



Average reception quality (< 50%) → orange smiley



Good reception quality (> 50%) → green smiley

Press  key permits to list the services distributed on the multiplex:

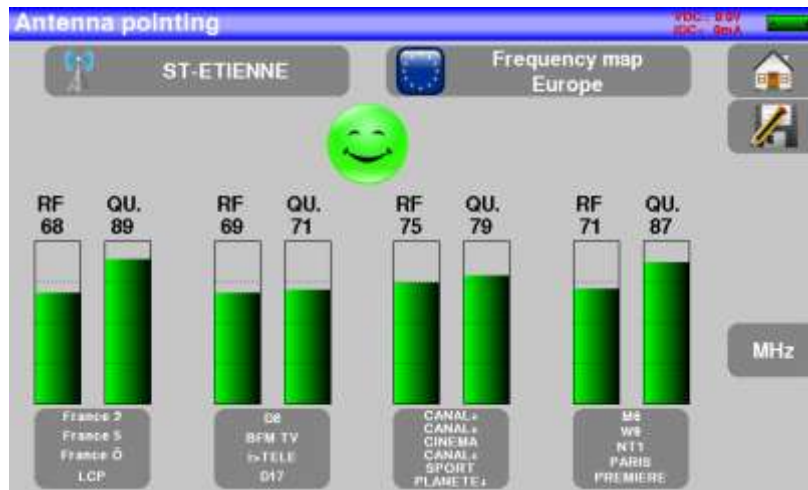

# 11 The Measures-TV-Spectrum page

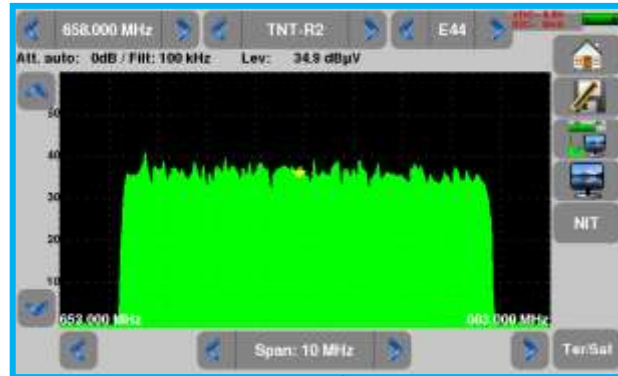

SPECTRUM mode full screen

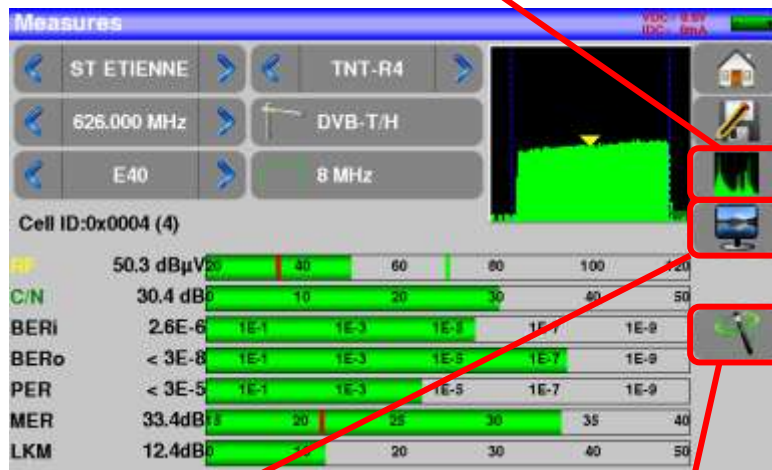

TV mode

Autolock : Automatic search of setup



# 12 Measures (MEASURES-TV-SPECTRUM)

Pressing the MEASURE zone gives access to the **MEASURES** function.

In this page, you can either perform measurements on a memorized program in the current list (see chapter « Measurement list »), or change parameters manually, or use the AutoLock function

## 12.1 Autolock function

This function is design to lock on a digital signal (terrestrial, cable or satellite)

You just have to enter the frequency or the channel (for terrestrial), then press AutoLock, The instrument will find automatically in few seconds the digital standard, the modulation type and all other parameters of the signal.

Example for terrestrial, channel 38 (frequency 610MHz):

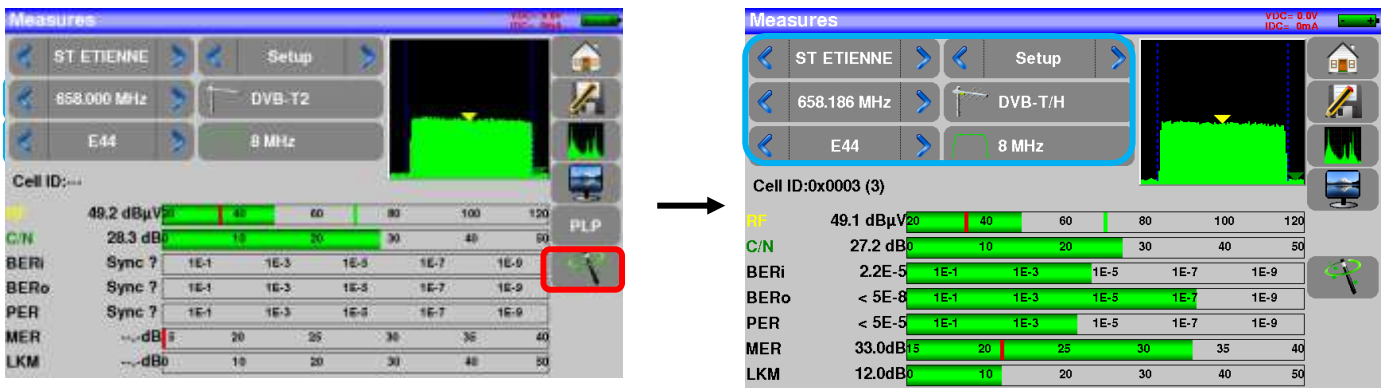

Example for satellite low vertical polarization, frequency 12109 MHz :

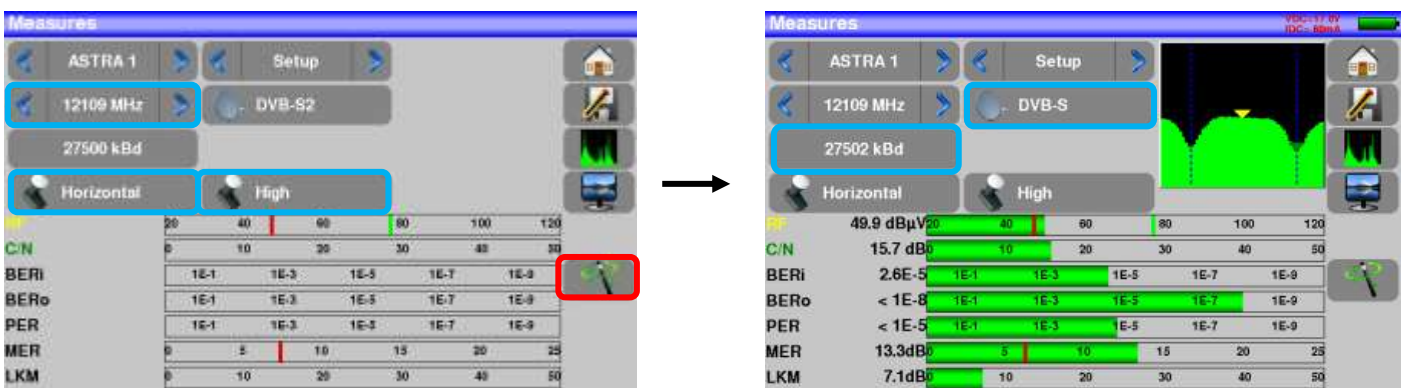

## 12.2 Modification of parameters

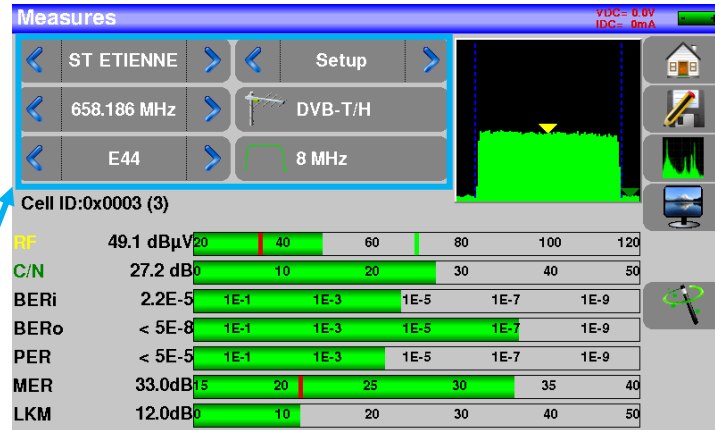



### The various parameters are:

- The name of the setup (selection on the active list)
- The frequency of the emitter or transponder (and the true frequency of satellite)
- The standard and bandwidth for DVB-T/H and DVB-T2
- The corresponding channel number for terrestrial and cable mode
- The symbol rate for the satellite
- The polarization and the band for the satellite
- The audio mode for the analogical TV

	<p>You can shift from terrestrial to satellite mode by:</p> <ul style="list-style-type: none"> <li>- Changing the setup frequency</li> <li>- Changing of standard</li> <li>- Changing of setup (from a terrestrial to a satellite setup)</li> </ul>
---	---

## 12.3 Level measurements

You can measure levels at a specific frequency with a detection matching the standard.

	<p>In terrestrial band, for an user socket, the level should be:</p> <ul style="list-style-type: none"> <li>- between 50 and 66 dBμV under FM</li> <li>- between 35 and 70 dBμV under DVB-T/H, DVB-T2</li> <li>- between 57 and 74 dBμV in any other case</li> </ul>
	<p>In satellite band, for an user socket, the level should be:</p> <ul style="list-style-type: none"> <li>- between 47 and 77 dBμV.</li> </ul>

**Example in terrestrial mode:**

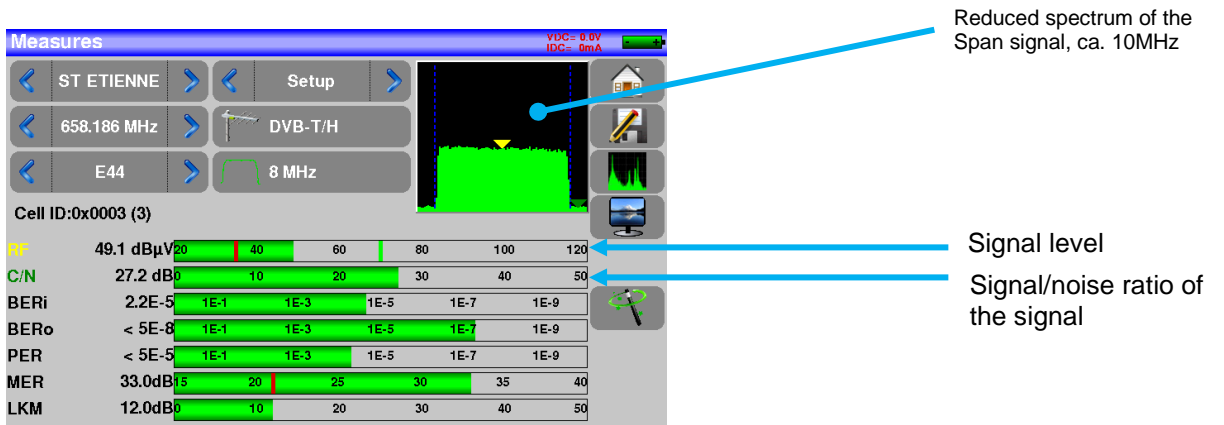

The appliance makes different measurements according to the current **standard**.

The other possible measurements are:

- **Average** measurement
- **Peak** measurement
- **Power** measurement.



The best is to be the closest possible of the green bar without exceeding it.  
For the MER measure, the value must be superior to the mini threshold.

## 12.4 Satellite band

The following table sums up the measurement types and the frequencies of the audio carrier waves for each standard:

Standard	porteuse vidéo	mesure
PAL	FM	Peak
SECAM	FM	Peak
NTSC	FM	Peak
DVB-S	Digital	Power
DSS	Digital	Power
DVB-S2	Digital	Power

## 12.5 Terrestrial band

The appliance automatically makes level measurements on the **Video carrier wave**.

The following table sums up the measurement types and the frequencies of the audio carrier waves for each standard:

Standard	Video carrier	Measure	Sound carrier		
			Mono	stéréo	NICAM
BG	negative, AM	peak	FM 5.5 MHz	FM 5.74 MHz	DQPSK 5.85 MHz
DK	negative, AM	peak	FM 6.5 MHz	FM 6.258 MHz	DQPSK 5.85 MHz
I	positive, AM	peak	FM 6.0 MHz		DQPSK 6.552 MHz
L	positive, AM	peak	AM 6.5 MHz		DQPSK 5.85 MHz
MN	negative, AM	peak	FM 4.5 MHz	FM 4.72 MHz	
DVB-C	digital	power			
DVB-T/H	digital	power			
DVB-T2	digital	power			
DAB/DAB+	numérique	power			
FM	FM	average			
Carrier	not modulated	average			

The appliance displays the level of the **Video** carrier wave and the **C/N** ratio.

## 12.6 Thresholds

Predefined thresholds are used to assess if the measurement is pertinent.

Standard	Min	Max
Terrestrial analog TV	57	74
DVB-C/C2	57	74
DVB-T/T2	35	70
DAB-DAB+	35	70
FM, Carrier	50	66
Satellite analog TV	47	77
DVB-S, DSS	47	77
DVB-S2	47	77

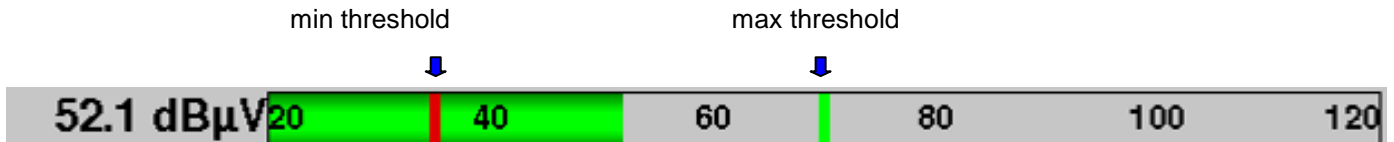



## 12.7 Digital measurements

In digital measurement mode, in addition to the **RF** level and to the **C/N** here above, the appliance also displays the various **BER** (Bit Error Rate), the **PER** (Packet Error Rate) and the **MER** (Modulation Error Ratio) under **DVB-T/T2/T2Lite**, **DVB-C/C2**, **DVB-S/S2** or **DSS**.

You also get the **LKM:x.xdB** (Link Margin) specification.

This expression in dB is the difference between the measured MER and the limit MER before disconnection of the image: **it's the security available before disconnection**.

- |   |   |
|---|---|
|    | <p>“<b>Sync ?</b>” displayed on screen means that the signal is absent or unlocked; check its presence, the modulation parameters, the presence of remote power supply and the LNB and DiSEqC parameters under satellite band.</p>              |
|  | <p>The sign &lt; before a value or error rate shows that there is no error but that <math>10^{-x}</math> bits have been tested (i.e. <math>&lt;10^{-8}</math> means that <math>10^8</math> bits have been tested).</p>                          |
|  | <p>You can shift from terrestrial to satellite mode by:</p> <ul style="list-style-type: none"><li>- Changing the setup frequency</li><li>- Changing of standard</li><li>- Changing of setup (from a terrestrial to a satellite setup)</li></ul> |

## 12.8 DVB-T/H

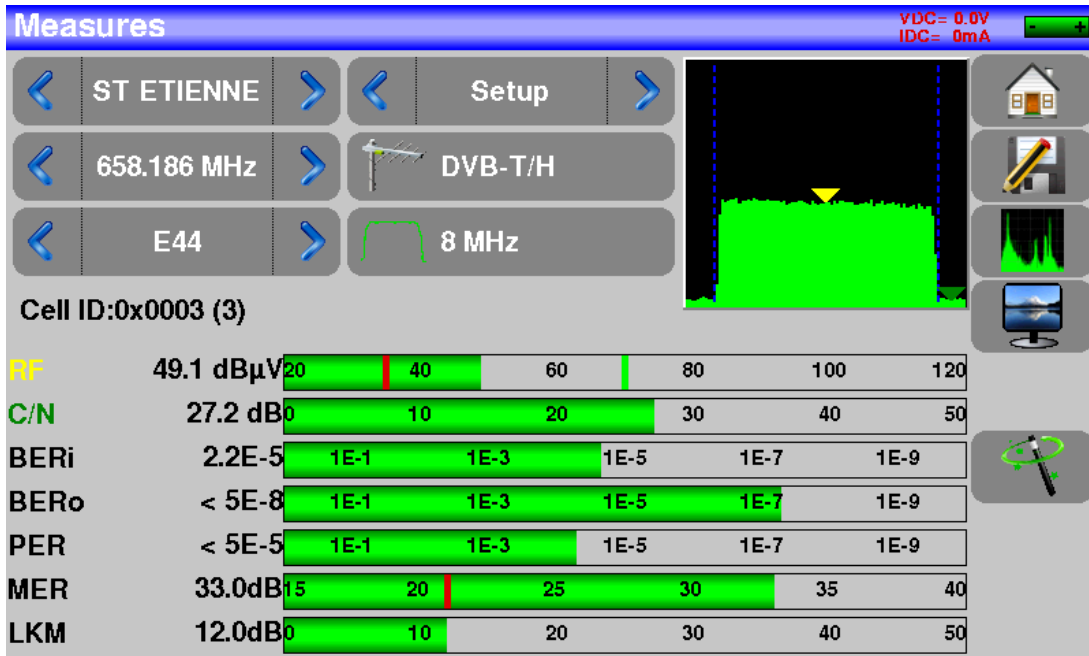
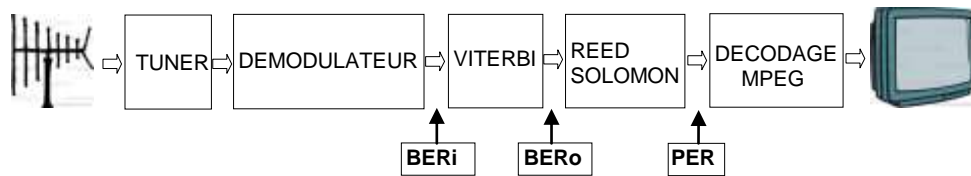

Display of the measures of:

- **BERi**: error rate before Viterbi
- **BERo**: error rate after Viterbi
- **PER**: error rate after Reed Solomon (error rate packet)
- **MER**: modulation error rate
- **LKM**: noise margin (Link Margin)

**BERx**: 'bits' error rate

Ratio between the number of false bits / number of transmitted bits during the measurement time

**PER**: 'paquets' error rate

Ratio between the number of false packets / number of transmitted packets during the measurement time

Recall: Under DVB-T/H, a packet is made of 204 octets; a packet is "false" if it includes more than 8 wrong octets (correction by Reed Solomon coding).

Display of the value of Cell ID from the diffuser and specific to the emitter.



## 12.9 DVB-T2 /T2 Lite

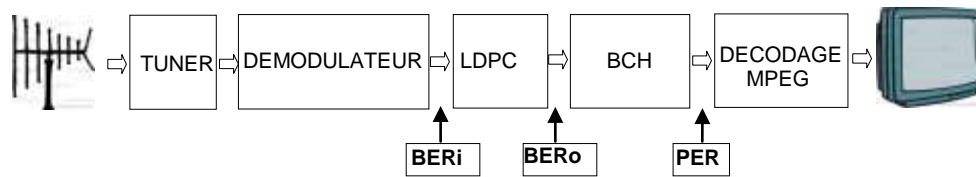

Display of the measures of:

- **BERi**: error rate before LDPC
- **BERo**: error rate after LDPC
- **PER**: error rate after BCH (lost packets)
- **MER**: modulation error rate
- **LKM**: noise margin (Link Margin)

Recall:

LDPC: Low Density Parity Check

BCH: Bose Chauhuri Houquenochem

The concatenation Viterbi + Reed Solomon of the correction of DVB-T/H has been replaced by the concatenation LDPC + BCH under DVB-T2.

Display of the values of Cell\_ID from the diffuser and specific to the emitter.

## 12.10 DVB-C

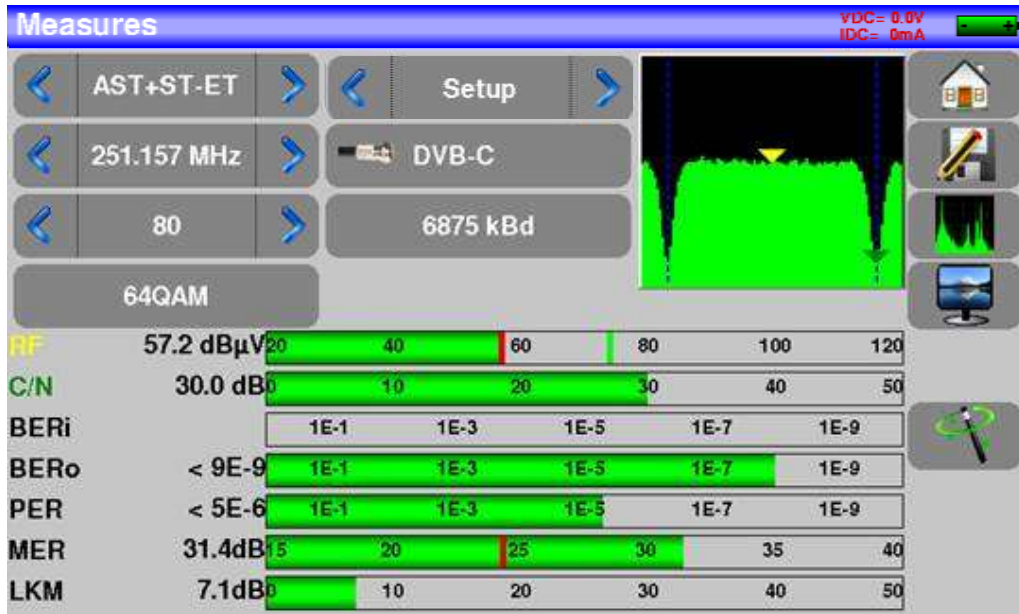
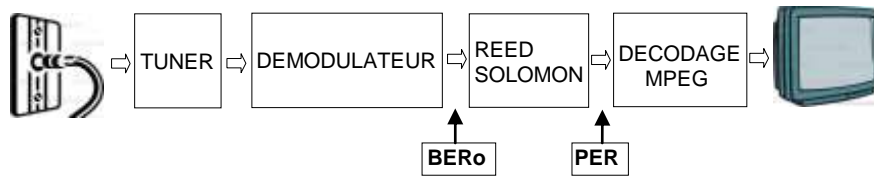

Display of the measures of:

- **BERo:** error rate before Reed Solomon
- **PER:** error rate after Reed Solomon (error rate packet)
- **MER:** modulation error rate
- **LKM:** Noise margin (Link Margin)

**BERo:** error rate 'bits'

Ratio between the number of false bits / number of transmitted bits during the measurement time

**PER:** error rate 'packets'

Ratio between the number of false packets / number of transmitted packets during the measurement time

Recall: Under DVB-C, a packet is made of 204 bites; a packet is "false" if it includes more than 8 wrong octets (correction by Reed Solomon coding).

## 12.11 DVB-C2

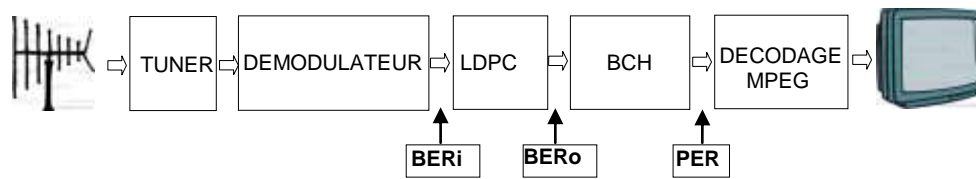

Display of the measures of:

- **BERi**: error rate before LDPC
- **BERo**: error rate after LDPC
- **PER**: error rate after BCH (lost packets)
- **MER**: modulation error rate
- **LKM**: noise margin (Link Margin)

Recall:

LDPC: Low Density Parity Check

BCH: Bose Chauhuri Houquenohem

- **Active PLP and Data slice**

## 12.12 DVB-S et DSS

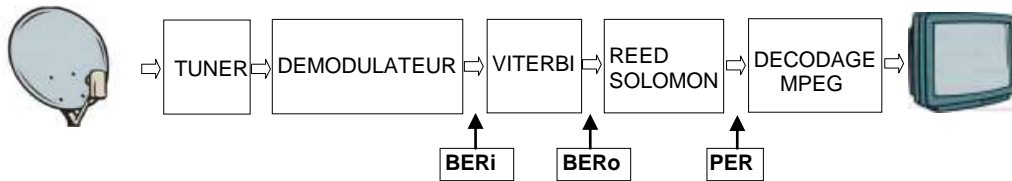

Display of the measures of:

- **BERi** : error rate before Viterbi
- **BERo** : error rate after Viterbi
- **PER** : error rate after Reed Solomon (error rate paquet)
- **MER** : modulation error rate
- **LKM** : Noise margin (Link Margin)

**BERx** : error rate 'bits'

Ratio between the number of false bits / number of transmitted bits during the measurement time

**PER** : error rate 'paquets'

Ratio between the number of false packets / number of transmitted packets during the measurement time

Recall: Under QPSK (DVB-S) a packet is made of 204 octets; a packet is "false" if it includes more than 8 wrong octets (correction by Reed Solomon coding). Under DSS, a packet is made of 146 octets.

## 12.13 DVB-S2

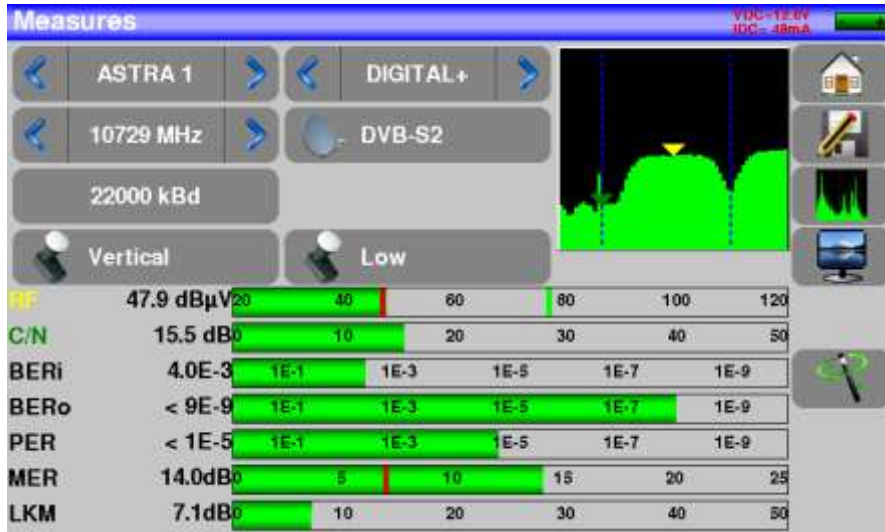
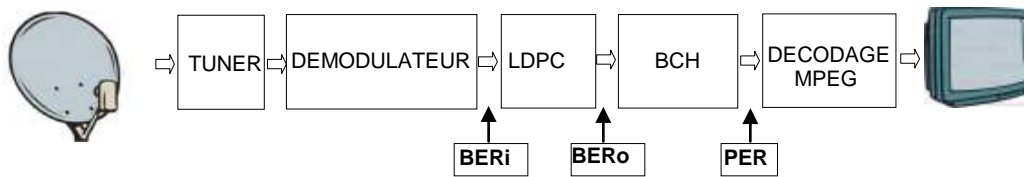

Display of the measures of:

- **BERi** : error rate before LDPC
- **BERo** : error rate after LDPC
- **PER** : error rate after BCH (lost packets)
- **MER** : modulation error rate
- **LKM** : Noise margin (Link Margin)

### Recall:

LDPC: Low Density Parity Check

BCH: Bose Chauhuri Houquenohem

The concatenation Viterbi + Reed Solomon of the correction of DVB-S has been replaced by the concatenation LDPC + BCH under DVB-S2.

# 13 Spectrum analyser

Pressing SPECTRUM gives access to the **SPECTRUM ANALYSER function**. (graphical representation frequency / amplitude of the present signals in the input of the device)

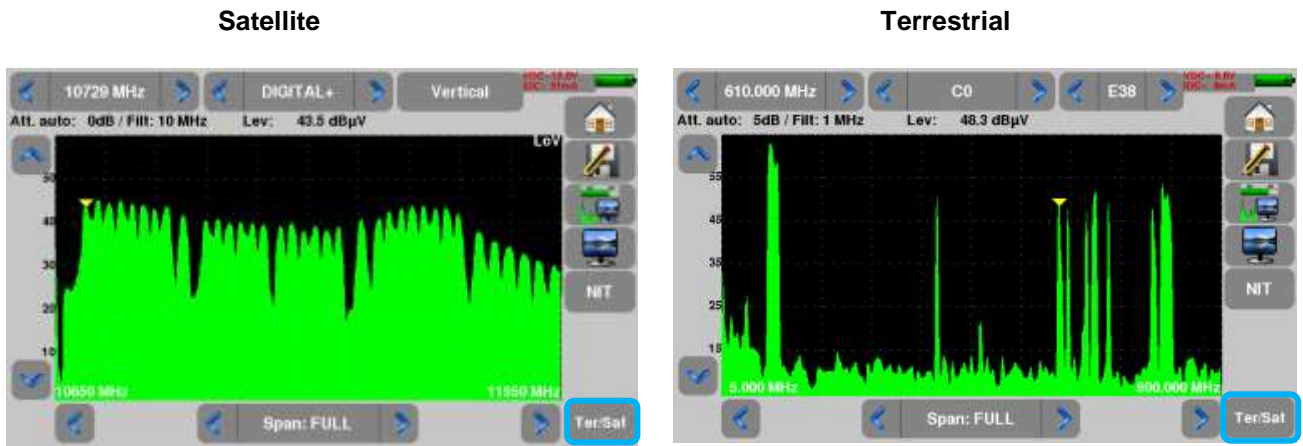

2 predefined bandwidths are available: terrestrial and satellite. To swap from satellite to terrestrial, press the key, as shown on the bottom side of the screen.

The input attenuator is automatically tuned according to the level of the signals measured.

Filters are automatically selected according to the « Span ».

The filter used is displayed on the upper left corner.

Parameters of the spectrum are:

**Frequency:** value of the frequency where the cursor is, user can enter a frequency value, or increase – decrease the frequency with <> keys

**Cursor:** simply press the area where you want to move or set the cursor

**List:** you can select a Program (in the current list)

**Channel:** use a channel for the spectrum (in terrestrial mode).

**Reference level:** can be modified with up-down arrows

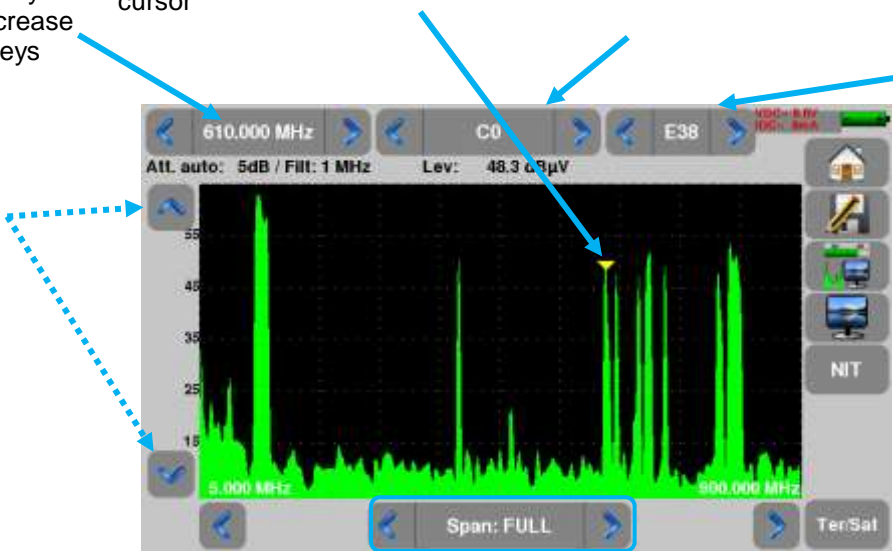

**Span :** frequency span around the center frequency

**Frequency range:** can be changed using the arrows

## 14 Image and Sound

Pressing the TV zone gives access to the TV function.

### 14.1 Digital TV

The name of the service and its main characteristics are displayed on top left of the screen.

- 720x576i: picture resolution 720 pixels / line, 576 lines, interlace
- 25 Hz: frame frequency
- MPEG-2: picture compression
- Video Rate 4.106 Mbits/s : instantaneous binary rate of the service
- Audio MPEG Layer II: sound compression

On this page, there are 3 keys at the bottom of the screen; they will be described in the next chapters



### 14.2 Full screen mode

Pressing the key  displays the image in full screen; only remain the battery level and the intensity + voltage of the remote power supply:

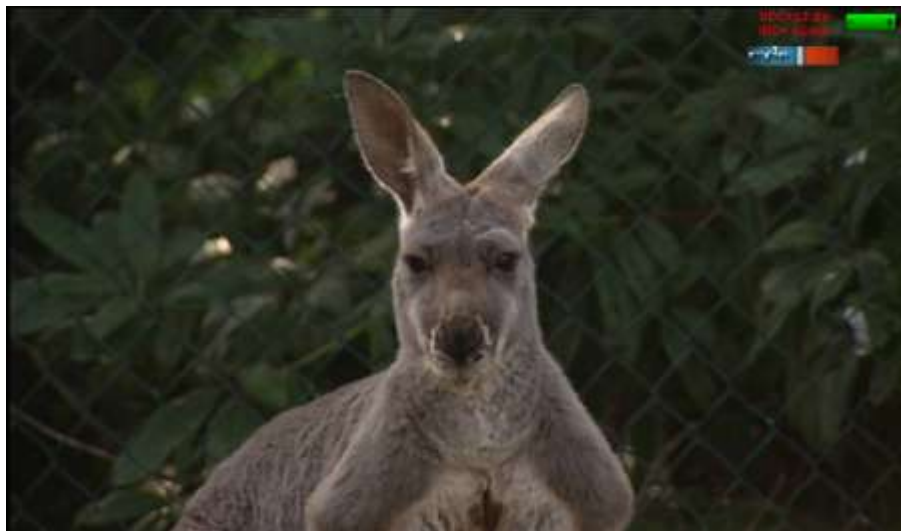

To exit, you only have to touch the screen anywhere.

## 14.3 Audio

To set the volume, press  an adjustment bar shows up:

**The instrument can decode the following digital sound formats:**

MPEG-1 L1/L2

AAC      Advanced Audio Coding      License Via Licensing

HE-AAC   High Efficiency AAC      License Via Licensing

Dolby Digital      License Dolby®

Dolby Digital Plus      License Dolby®

Made under **licence** by **Dolby** laboratories.

**Dolby** and the double-D symbol are trademarks of **Dolby Laboratories**

## 14.4 Table of services

Pressing  gives access to the list of services:



Service list						
	Service	Provider	SID	LCN	A	Type
	D8	NTN	513	8		Digital TV
	BFM TV	NTN	515	15		Digital TV
	i>TELE	NTN	516	16		Digital TV
	D17	NTN	517	17		Digital TV
	Gulli	NTN	518	18		Digital TV
	France 4	NTN	519	14		Digital TV

This function allows selecting the channel you want to display. You only have to press the line you want.



# 15 Remote power supply / LNB – DiSEqC

The  LNB-DiSEqC key gives you access to the remote power supply / LNB-DiSEqC. To start the remote power supply, press the key after Remote supply:

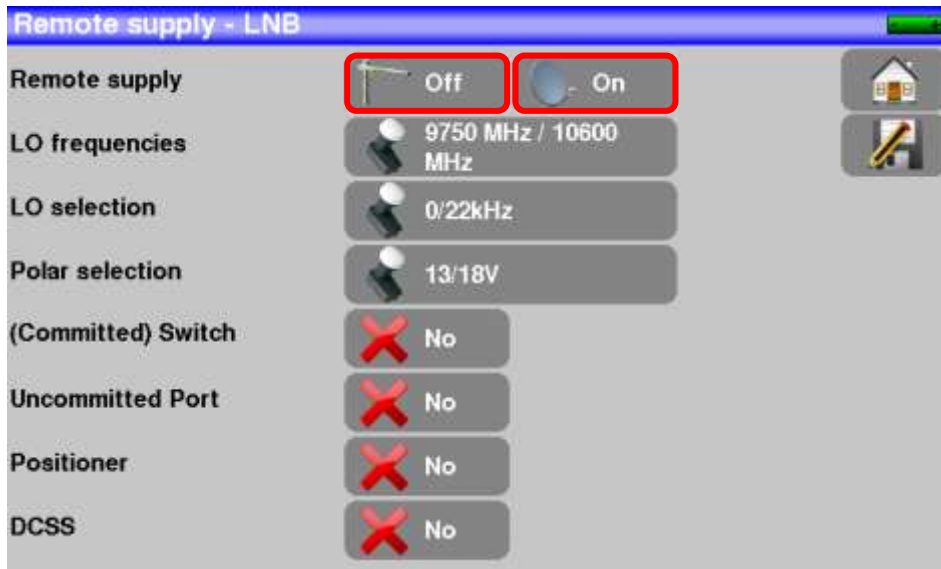

## 15.1 Terrestrial band

In terrestrial mode, you can select:

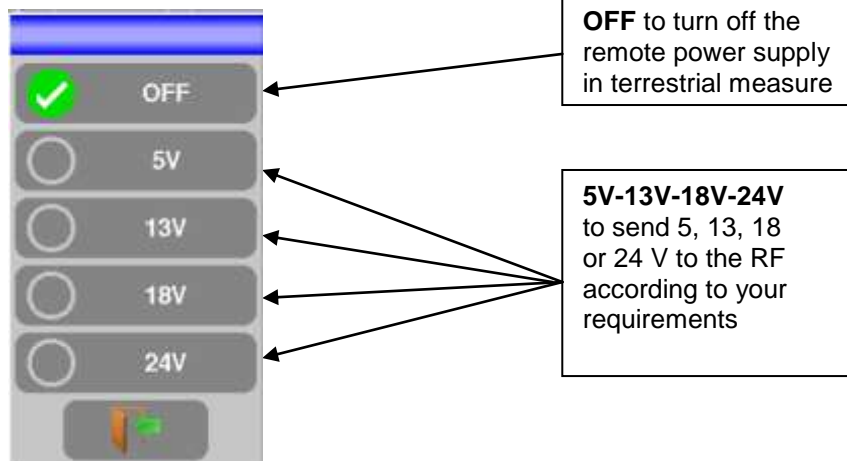

A green check shows which voltage is selected.

## 15.2 Satellite band

### 15.2.1 Power ON

#### Setting the remote power supply to satellite:

**OFF** to turn off the remote power supply under satellite measure

**ON** to turn on the remote power supply under satellite measure

**AUTO** to launch automatically the remote power supply in satellite measure mode even after shutting off

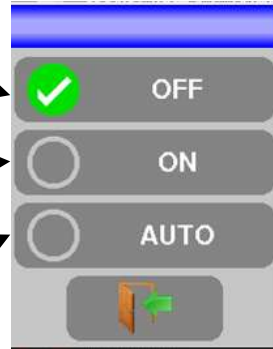

#### Configuration lines:

**- LO1 and LO2 Frequency:**

LO frequencies low and high band of LNB

**- LO selection:** band commutation on the LNB (22kHz, ToneBurst or DiSEqC)

**- Selection polar :** polarization commutation on the LNB (13/18V or DiSEqC)

**- Switch:** switch type and position (No, ToneBurst, 22kHz, DiSEqC, Pos A, B, C or D)

**-Uncommitted:** "Uncommitted" switch type and position (No, DiSEqC, Pos 1 to 16)

**-Positioner:** presence of a positioner (Yes / No)

**-DCSS:** Digital Channel Stacking (2 modes SATCR and SCD2 single cable distribution)

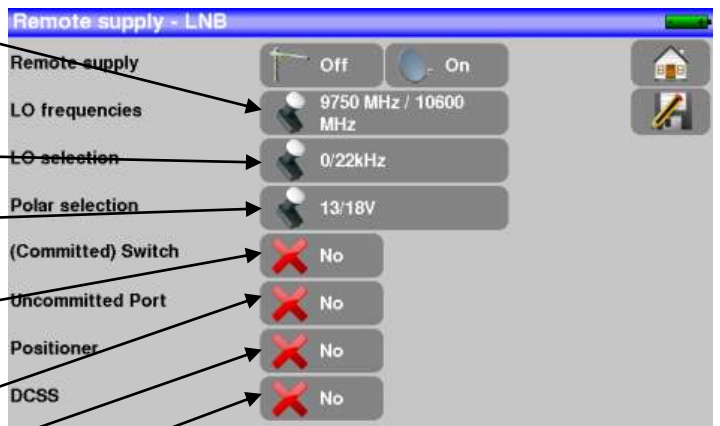

See chapter [Man-machine interface](#) for any change.

### 15.2.1 Switches

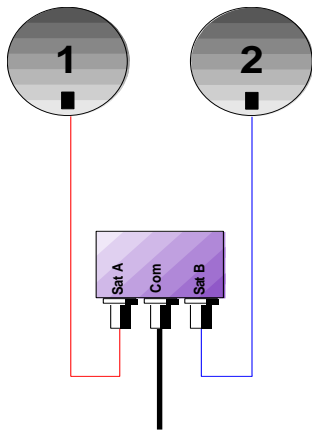

2-satellite switch

\* 22 kHz

\* ToneBurst (MiniDiSEqC)

\*DiSEqC Committed or Uncommitted

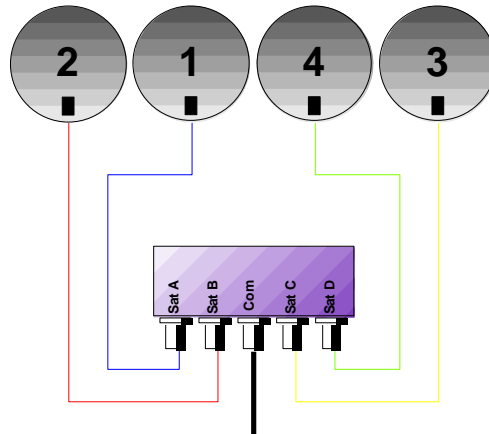

4-satellite switch

\* DiSEqC Committed or Uncommitted

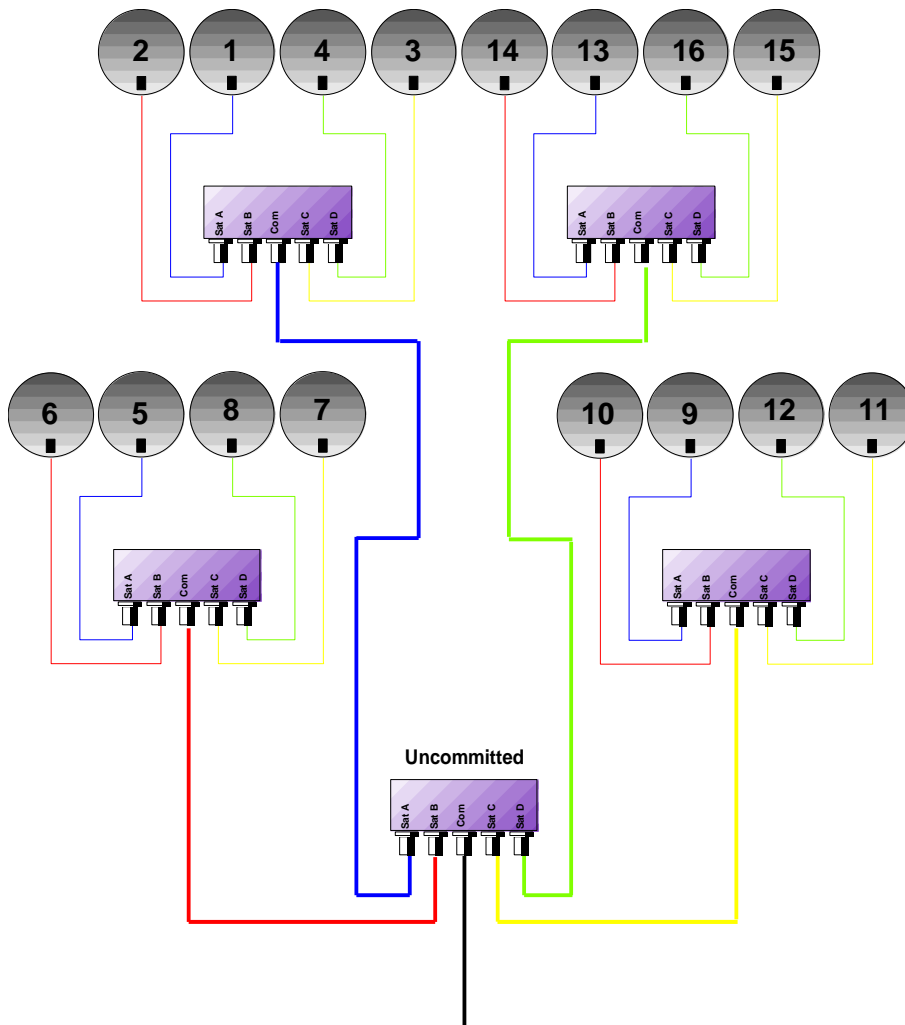

16-satellites switch

\* DiSEqC Committed + Uncommitted

Satellite	Switch line		Uncommitted line	
	Position	Commande DiSEqC	Position	Commande DiSEqC
1	Pos A	Option A + Position A	Pos 1	Input 1
2	Pos B	Option A + Position B	Pos 1	Input 1
3	Pos C	Option B + Position A	Pos 1	Input 1
4	Pos D	Option B + Position B	Pos 1	Input 1
5	Pos A	Option A + Position A	Pos 2	Input 2
6	Pos B	Option A + Position B	Pos 2	Input 2
7	Pos C	Option B + Position A	Pos 2	Input 2
8	Pos D	Option B + Position B	Pos 2	Input 2
9	Pos A	Option A + Position A	Pos 3	Input 3
10	Pos B	Option A + Position B	Pos 3	Input 3
11	Pos C	Option B + Position A	Pos 3	Input 3
12	Pos D	Option B + Position B	Pos 3	Input 3
13	Pos A	Option A + Position A	Pos 4	Input 4
14	Pos B	Option A + Position B	Pos 4	Input 4
15	Pos C	Option B + Position A	Pos 4	Input 4
16	Pos D	Option B + Position B	Pos 4	Input 4

## 15.2.1 Positioner

The appliance sends a DiSEqC command that triggers the rotation of a motorized satellite dish.

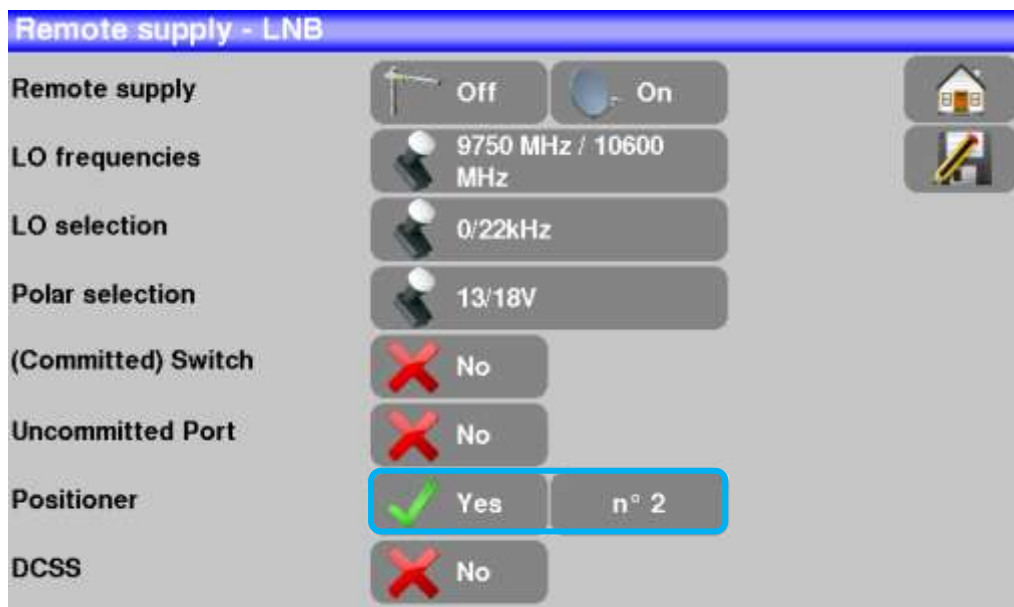

In this example, the position is 2 (1 to 127 pre-loaded positions in the positioner)

If the positioner is on No, it is deactivated

See chapter [Man-machine interface](#) for any change.

## 15.2.2 DCSS

### Description:

**DCSS** Digital Channel Stacking system: signal distribution system using frequency transposition.

Used in satellite distribution for multiple or single dwelling, with several set top boxes.

To give several receptors access to the whole spectrum and all polarizations, you need **one coaxial cable per receptor** and a suitable installation (multiple LNB, Quattro and multi-switches).

The **DCSS system** allow to feed dwellings with one or more satellites using only one coaxial cable (**SCD=SINGLE CABLE DISTRIBUTION**).

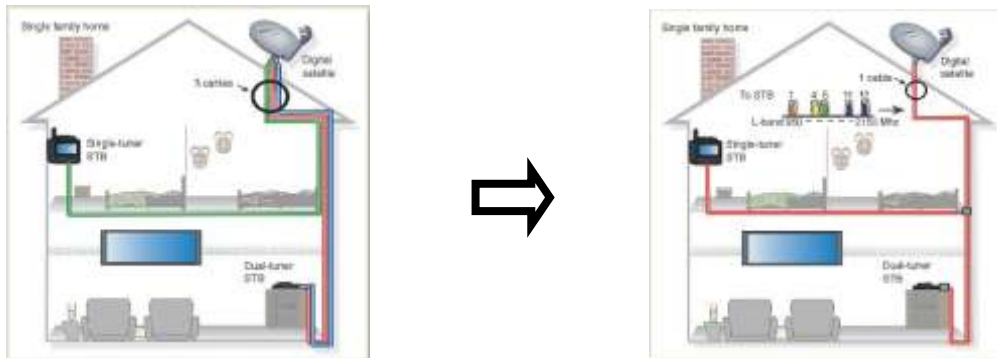

The DCSS is an extension of the DiSEqC protocol that allows the connection of several receptors on **only one coaxial cable**, no matter the band (H/L) and the polarization (H/V).

### Functioning:

Each satellite receptor uses a fix frequency band (**Slot** or **Port**), whose width is (more or less) equal to the width of the transponder.

The receptor requires a specific transponder frequency (frequency Ku) via a DiSEqC command.

Some equipment on the satellite dish (LNB or switch) moves the requested signal to the center of the selected band (**Slot**). Then, the mixing equipment adds each user band (**Slot**) to only one output (up to 32 user bands).

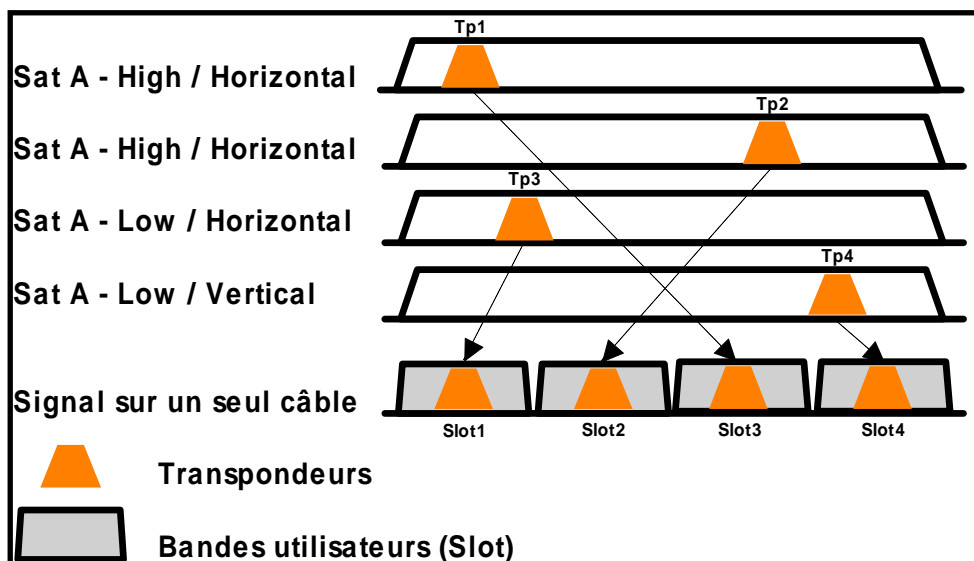



**The DCSS mode has priority on all other modes: selection polarization, selection OL, switches committed and uncommitted and positionner.**

**2 Modes :**

**SATCR :** Satellite Channel Router, standard EN50494 (or SCD, Unicable, ...)

Distribution of the satellite signal with only one coaxial cable to 2, 4 or 8 different receptors.

**SCD2 :** Single Cable Distribution v2, standard EN50607 (or SCD2, Unicable II, JESS)

Distribution of the satellite signal with only one coaxial cable to a maximum of 32 different receptors.

Using Diseqc 2.0 bi-directional possibility to ask current online devices and speed up installation.

**Mode choice:** press DCSS

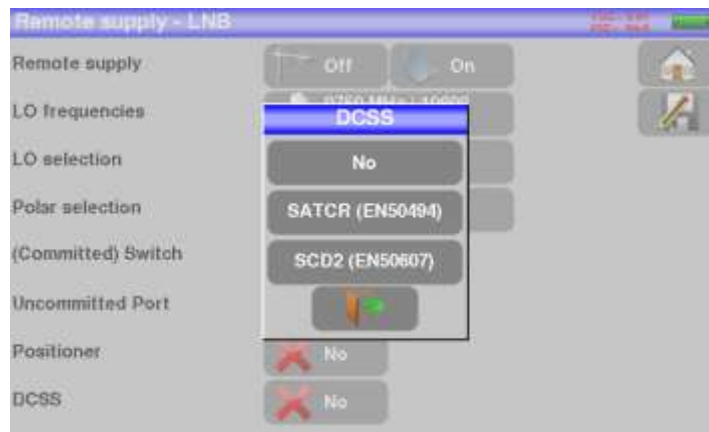

**SATCR (EN50494) :**



- SLOT x: active Slot choice
- CONFIG: access to each slot configuration



Slots list, frequencies and switch PosA/PosB

- INITIALISATIONS: 8 predefined slots
- ITALY: 4 predefined slots for Italy
- DETECT: automatic detection of slots (spectrum detect based)

T



## 16 Constellation

The  Constellation key gives you access to the **CONSTELLATION** function.

These measures are available if one of these standards is running in the **LEVEL MEASUREMENT** page.

- DVB-T/H
- DVB-T2
- DVB-C
- DVB-C2
- DVB-S, DSS, DVB-S2

The appliance displays the **Constellation** of the current signal.

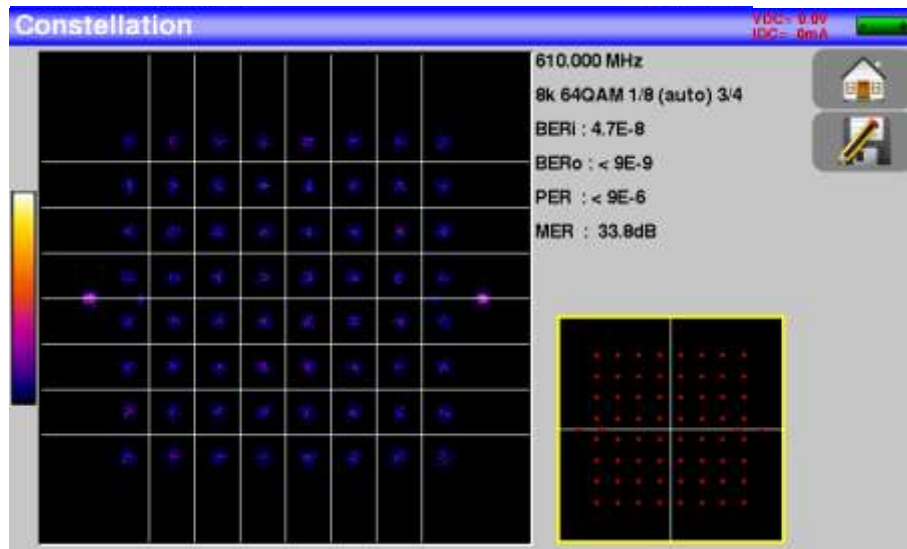

The information displayed on the right of the **Constellation diagram** is:

- current frequency
- modulation
- constellation
- symbol rate
- error rate and MER



# 17 Echo / Guard interval



Available only for DVBT/H, DVB-T2 or DVB-C2 standards.

Pressing  allows you to access to **Echo Guard interval measurement**.

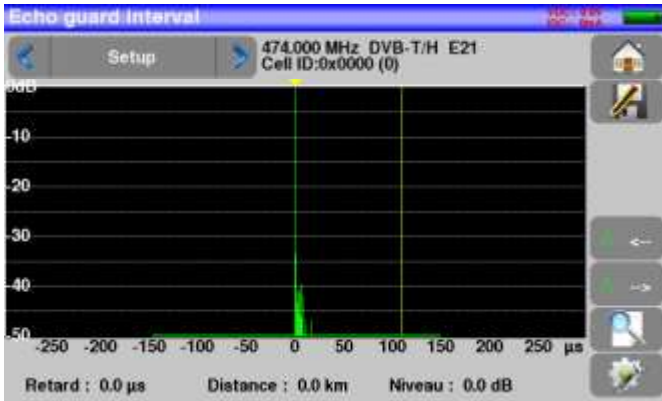

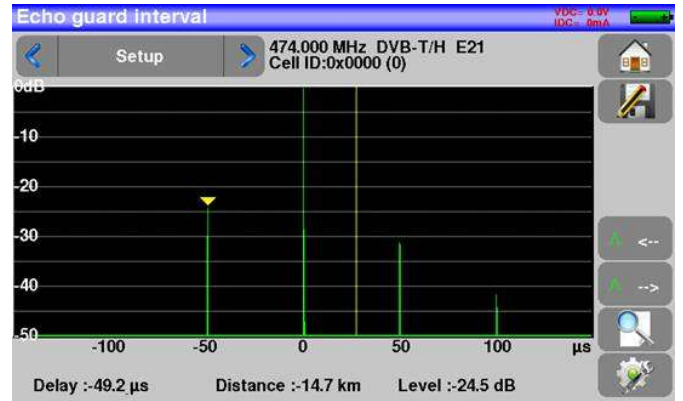

Signal without echo



Signal with echoes and pre-echoes

Pressing  changes the horizontal scale (distance).

Horizontal scale can be set in  $\mu$ s, km or miles by pressing .

Moving measurement arrow  can be done by screen touch, or by automatic search keys 

and .

The end of the guard interval is displayed with a **yellow line**.

## Reminder :

Remember: In terrestrial TV broadcasting, the received signal on the antenna comes from several possible ways: the **echoes**.

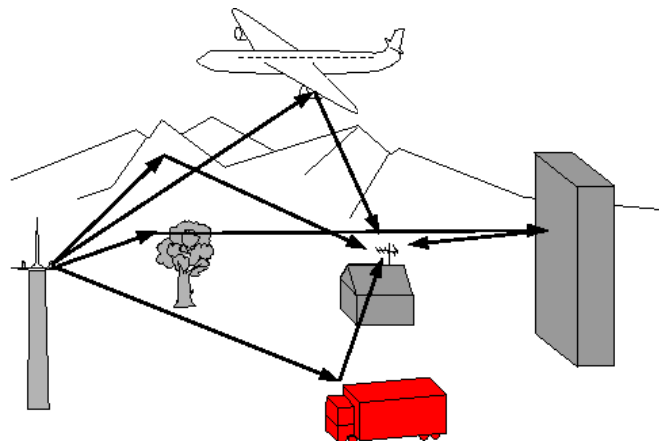

In digital TV DVB-T/H and DVB-T2, these echoes may help or degrade the image according to the time delay between the various signals that reach the antenna.

The broadcasting norms DVB-T and DVB-T2 define a modulation parameter called "**guard interval**" where echoes won't disturb the reception.

The transmission of digital data (**Symbol**) is interrupted during the **guard interval**.

A delayed (or advanced) symbol of any **shorter** duration than the guard interval will not disturb the reception.

A delayed (or advanced) symbol of any **longer** duration than the guard interval will disturb the reception.

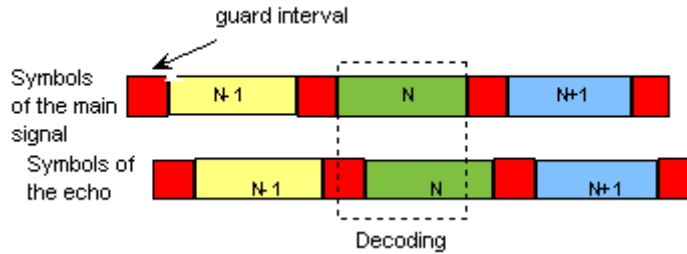

You have to reduce the level of reception of the echoes by orienting the antenna or by selecting a more directive antenna.

The **Echo** function of the appliance enables you to display possible **echoes** that disturb the received signal.

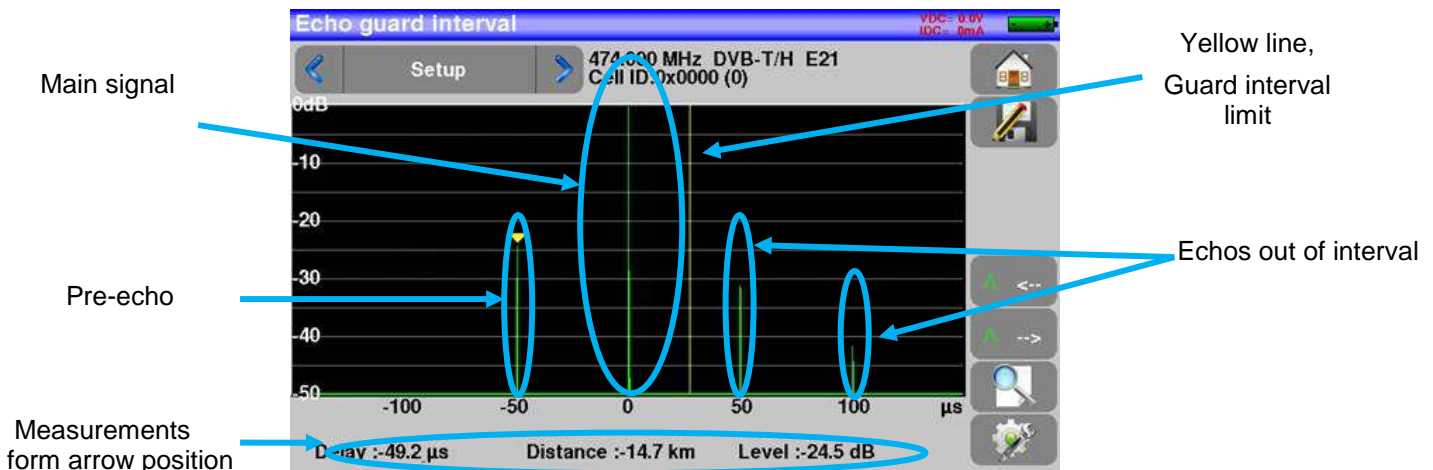

Relative amplitude in dB and delay in  $\mu\text{s}$  (distance in km) from the main signal (0 pulse) can be measured.

The **yellow line** represents the end of the guard interval.

Echoes and pre-echoes (pulses) above the yellow line disturb the signal and must be reduced as much as possible.

The echoes (pulses) beyond this line disturb the reception and must be as weak as possible.

	<p>Attention: a high amplitude echo pulse within the guard interval will also disturb the signal quality.</p>
---	---

# 18 Measurement map

To access the **MEASUREMENT MAP** function, press Home then Measurement map:



It is an automatic level and error rate measurement of the setups in the measurement list with labeling of the levels beyond tolerance.

Measurement result for channel 38 under DVB-T/H





Measurement map

ST ETIENNE

VDC= 0.0V  
IDC= 0mA

1/9

freq.	std	RF	C/N	BERi	BERo	PER	MER
E38	DVB-T/H	51.5	31.1	1.4E-7	<1E-8	<1E-5	33.7
E44	DVB-T/H	49.2	29.3	3.5E-5	<1E-8	<1E-5	32.9
E59	DVB-T/H	51.0	31.1	2.3E-7	<1E-8	<1E-5	33.7
E40	DVB-T/H	50.9	31.0	4.9E-6	<1E-8	<1E-5	33.1
E49	DVB-T/H	52.0	31.6	1.4E-7	<1E-8	<1E-5	33.5
E46	DVB-T/H	51.2	30.8	9.5E-8	<1E-8	<1E-5	33.8
88.000	FM	57.3	>57.3				

	<p><b>BERi, BERo and PER</b> are generic terms (frequently used)</p> <p><b>BERi</b> = BER in = inner BER  first BER treated by the demodulator (BER channel, CBER, LDPC)</p> <p><b>BERo</b> = BER out = outer BER  last BER treated by the demodulator (BER Viterbi, VBER, BCH)</p> <p><b>PER</b> = packet error rate  non-proofread packet, lost packet, wrong packet (UNC, PER)</p>
	<p><b>Important:</b>  A bargraph above the Measurement map allows you to track the evolution of the scan.</p> <p>The background color of this bargraph shows you that a complete scan has been made (for a save, for example):</p> <ul style="list-style-type: none"> <li>- <b>red</b>: the measurement map has not been totally scanned yet</li> <li><b>green</b>: the measurement map has been totally scanned</li> </ul>
	<p><b>In case of mixed measurement map (terrestrial+satellite)</b>, the satellite remote power supply has priority (the terrestrial remote power supply is ignored).</p>

## 18.1 Out of tolerance values

The digital values are colored according to the **Thresholds** before decision

- **red** for values less than **Threshold min**
- **orange** for values more than **Threshold max**

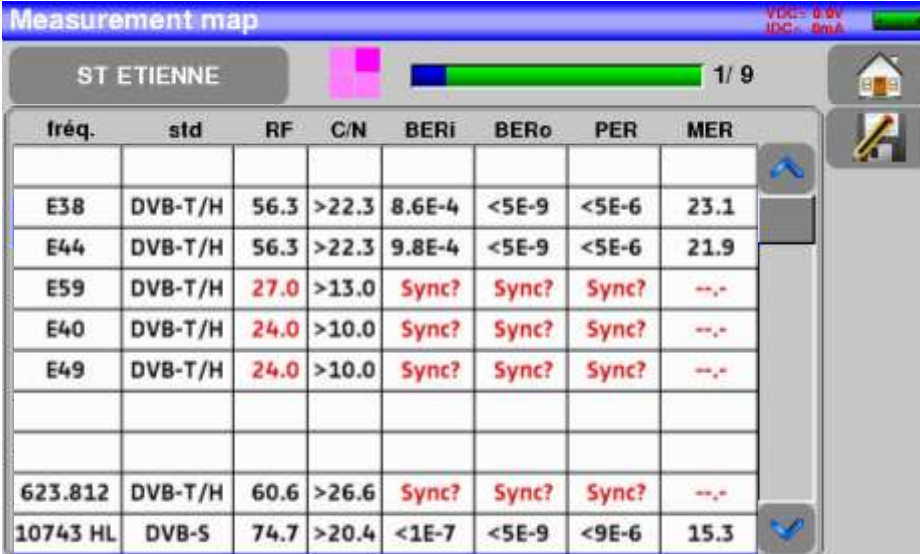

fréq.	std	RF	C/N	BERi	BERo	PER	MER
E38	DVB-T/H	56.3	>22.3	8.6E-4	<5E-9	<5E-6	23.1
E44	DVB-T/H	56.3	>22.3	9.8E-4	<5E-9	<5E-6	21.9
E59	DVB-T/H	27.0	>13.0	Sync?	Sync?	Sync?	--,-
E40	DVB-T/H	24.0	>10.0	Sync?	Sync?	Sync?	--,-
E49	DVB-T/H	24.0	>10.0	Sync?	Sync?	Sync?	--,-
623.812	DVB-T/H	60.6	>26.6	Sync?	Sync?	Sync?	--,-
10743 HL	DVB-S	74.7	>20.4	<1E-7	<5E-9	<9E-6	15.3

# 19 Configuration

For configuration, go to the Home page, then Configuration



## 19.1 Language

You can select your language by pressing the « flag » (below). Press the flag corresponding to your language:



## 19.2 Frequency map

This key allows you to select the terrestrial frequency map of the appliance:



### 19.3 Memories

To save a picture or any other feature, see chapter [Save](#)

The number of saved file and their memory size are displayed.



When pressing this key, a pull-down menu lists the previously saved files.

The first column contains the order number of the file; the second column contains the name of the file; the last column contains the type of file: Measure, Spectrum, Measurement map...

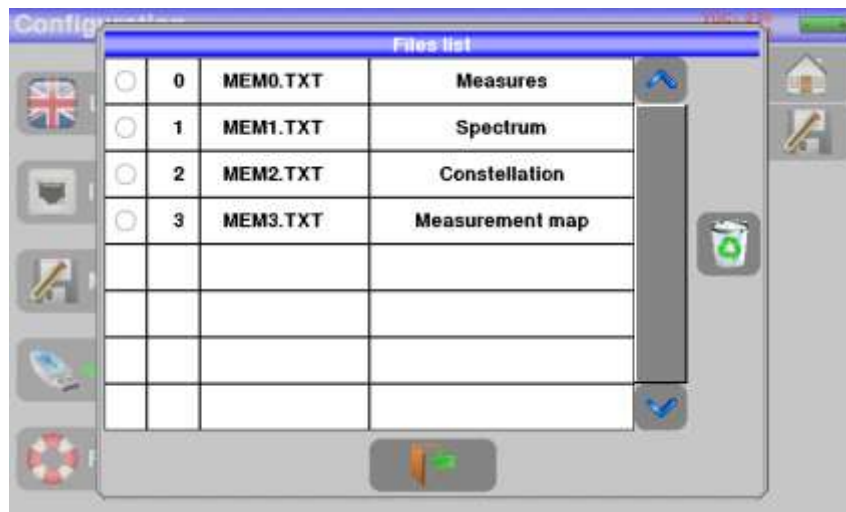

By pressing a line of the table, you open a window:

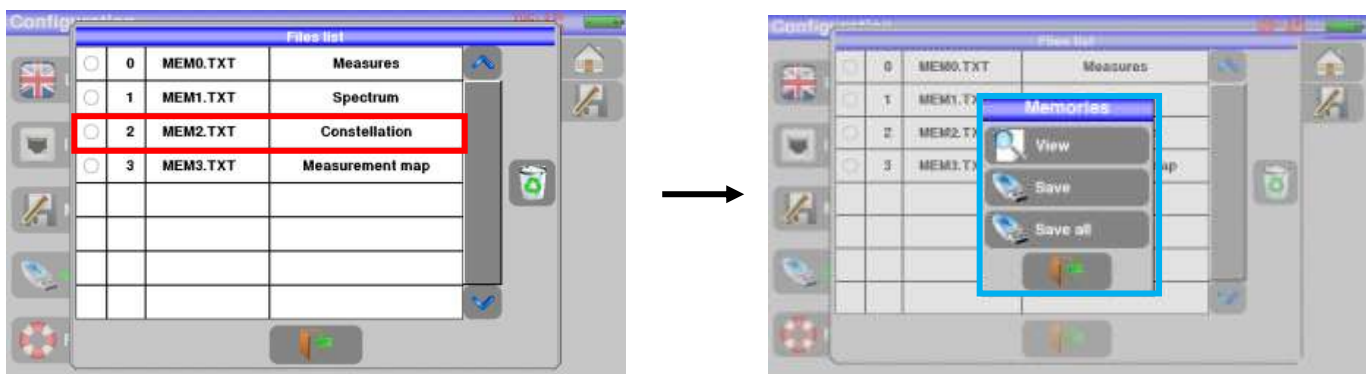

### 19.3.1 View

This key allows the display of the content of the file:

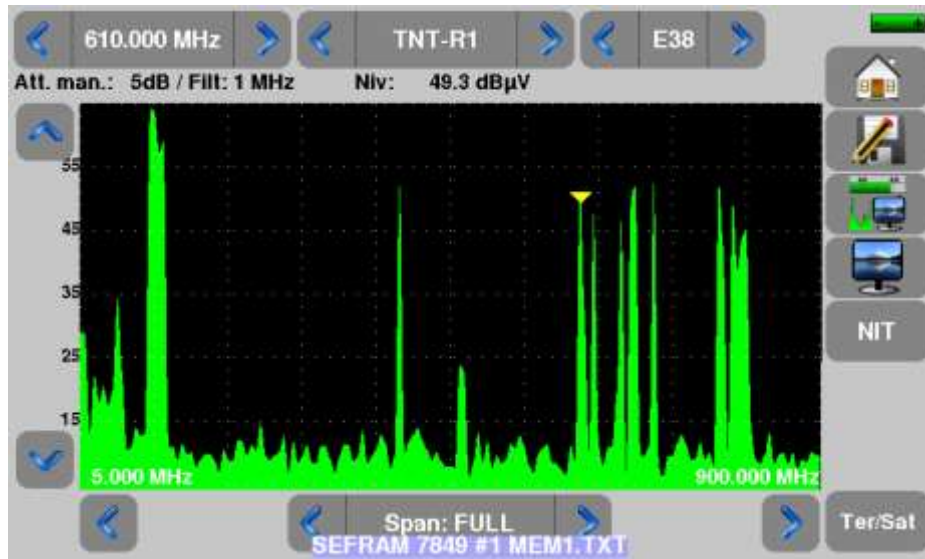

### 19.3.2 Save

- **Save (BMP -> USB)** allows you to export the file to the USB stick under BMP format (non-compressed graph); it is useful to transfer graphs to a report in a PC computer.

Here is the BMP file of the previously displayed DVB-T/H channel, edited on PC to have the spectrum full screen.

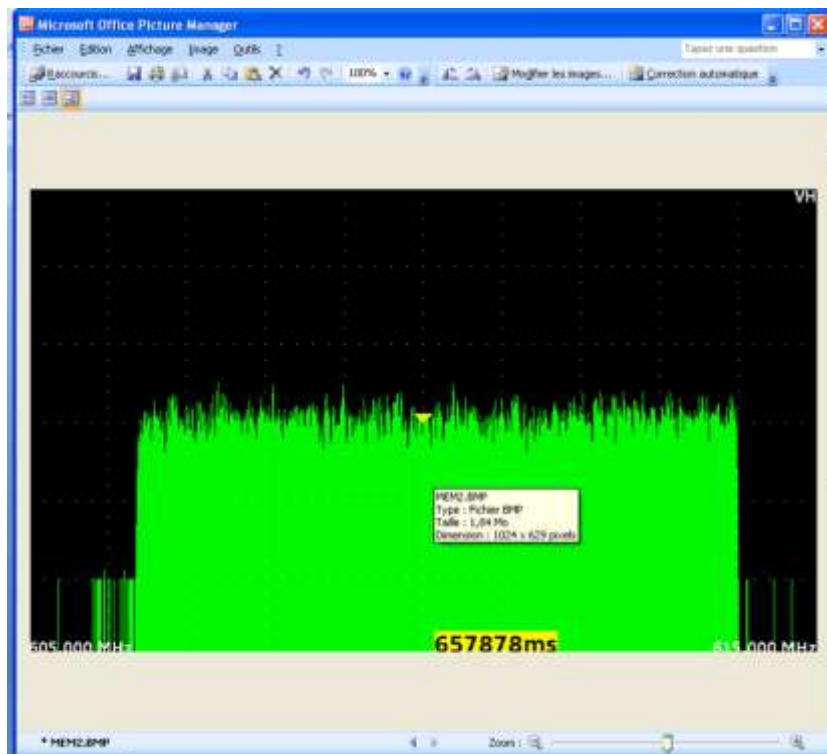

- **Save (CSV -> USB)** allows you to export the file to the USB stick under CSV format (text file by columns separated with semicolons); it is useful to analyze values in a spreadsheet.

Here is the spectrum here above with a curve under EXCEL™.

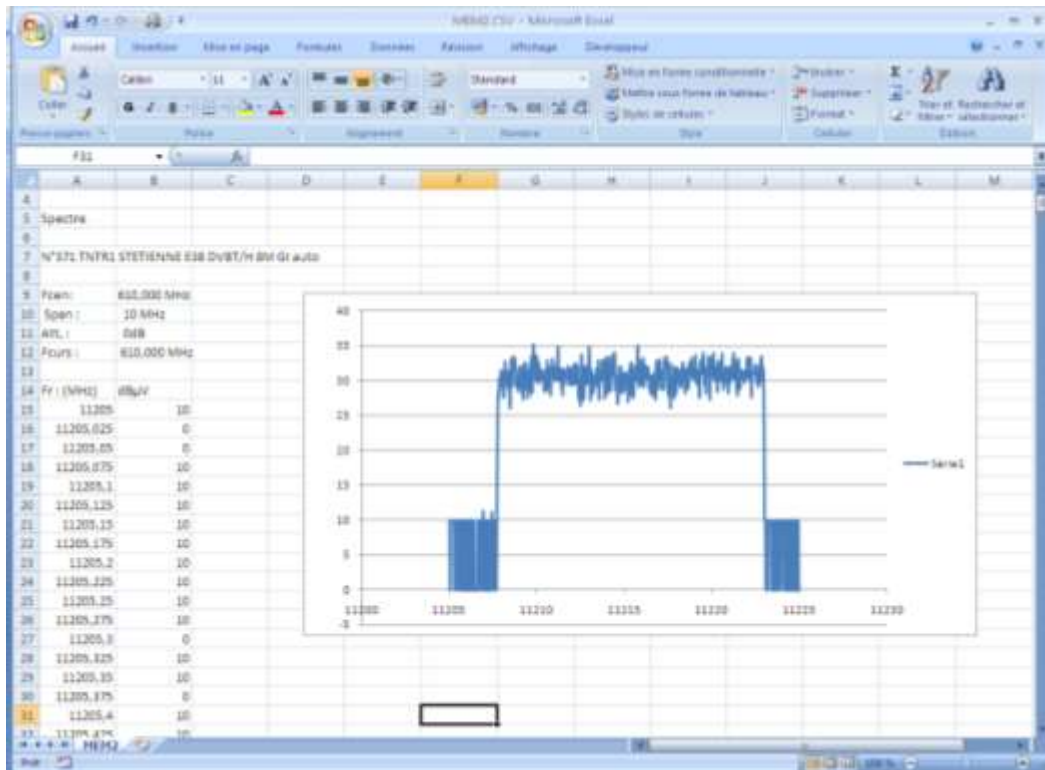

- **Save all (BMP -> USB)** records all files from the appliance under BMP format into separated registers:
  - LEVEL for the level measurements
  - MAP for the measurement maps
  - SPECTRUM for the spectrum measurements
  - BER-MER for the error rate measurements
  - CONST for the constellations
  - ECHO for the echoes.
- **Save all (CSV -> USB)** also records all files from the appliance into separated registers, but under CSV format.

### 19.3.3 Update

See chapter [Software update](#) for more details.



## 19.4 Factory recovery

A complete set-up of the appliance under its FACTORY configuration, with confirmation

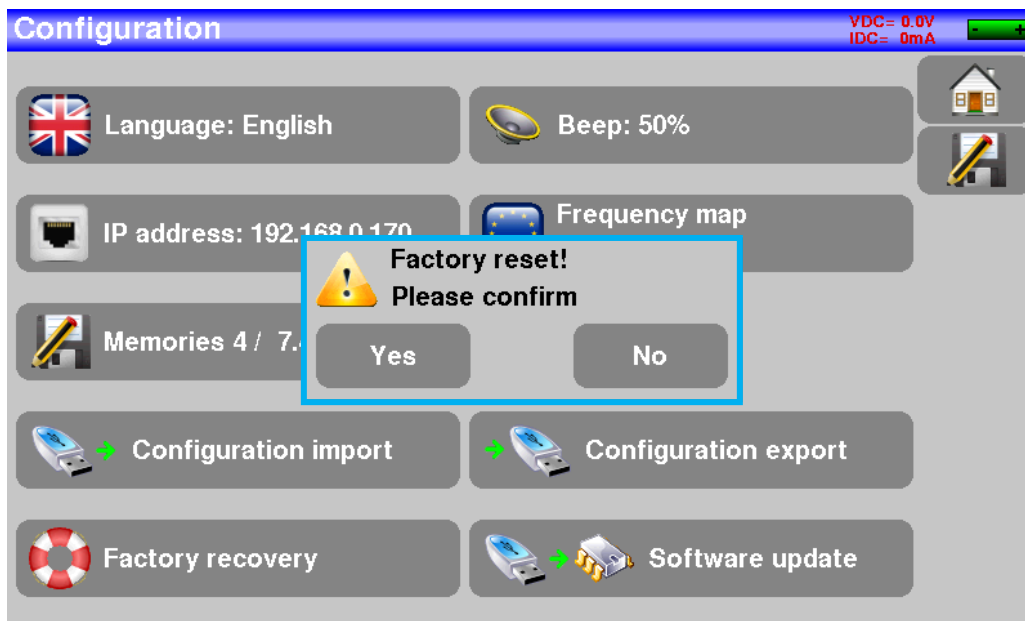

	<p><b>Attention:</b> In case of factory recovery, you <b>lose</b>:</p> <ul style="list-style-type: none"><li>- the setup library</li><li>- the measurement lists</li></ul>
--	--

## 19.5 Configuration import/export

You can make a backup on a USB stick of your setups/lists of your appliance by pushing « « Configuration Export ».

And you can import from a USB stick this configuration with the touch “Configuration import”. You can also update checksat/antenna pointing configuration available on SEFRAM’s website:

[http://www.sefram.com/Maj\\_soft/Sat.csv](http://www.sefram.com/Maj_soft/Sat.csv)

## 20 Software update





**Attention:** Take care that the remaining battery life is sufficient (> 30%), else plug the appliance on the mains with the provided adapter.

You can easily update the software to get new functionalities.

The update requires an USB stick.

To achieve the update:

- Download the update file **784X\_VX.X fichier zip** on our website ([www.sefram.fr](http://www.sefram.fr))
- Insert a USB stick on your PC
- Unzip the file onto the root of the memory stick
- Pull the USB stick off from your computer
- Turn your appliance on

- Go to the Home page,  press configuration 

- Insert the USB stick into the connector of the appliance.

- Select Update: 



**Attention:** Do not turn the appliance off while updating

The updating process lasts ca. 10 minutes. At the end of the update, the appliance asks you to restart the appliance. The software is then loaded into your appliance.

Error messages may show up: **Do not take them into account.**

## 21 Save

Pressing  opens a window (here, on the Measurement page):



In this window, you can save the current measurement parameters from the active list, make a screenshot to a USB stick under BMP format or make a save into internal memory.

You can rename the save file (see chapter [Man-machine interface](#)).

The default name of the save is MEM(X+1) (X is the number of saves in the appliance).

You will be suggested a save into internal memory only in the **Spectrum, Measurements, Constellation, Guard interval** and **Measurement map** pages.



After transfer, you will be able to use the saved measures to create measurement reports on your computer (see paragraph [Saves](#) for more details).



When you stop the appliance, it may need a few seconds to stop completely because the save on flash memory is carried out during the extinction.

## 22 Connection of the appliance to a PC

The appliance has an ETHERNET interface that makes it possible to connect directly to a PC.

For this type of connection, no driver is necessary.

Connect your appliance to your PC by using a crossed ETHERNET cable (available in option with the number 298504246 asking SEFRAM).

- **Configuration of the connection:**

**Ethernet** connection of your appliance to the PC.

To change the IP address of your appliance, press  and:

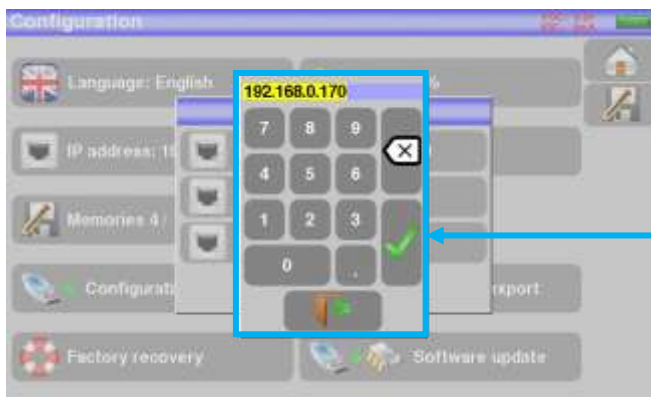
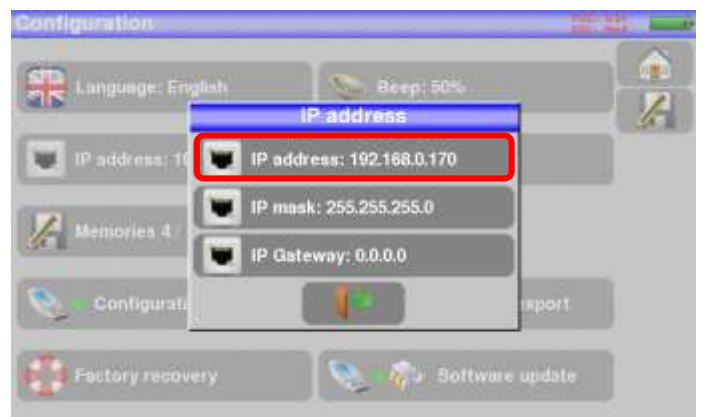

With the virtual digital keypad, type the IP address you want, then validate with ENTER

The PC software in communication with the appliance must have the same IP address as the appliance, just like in the example below:

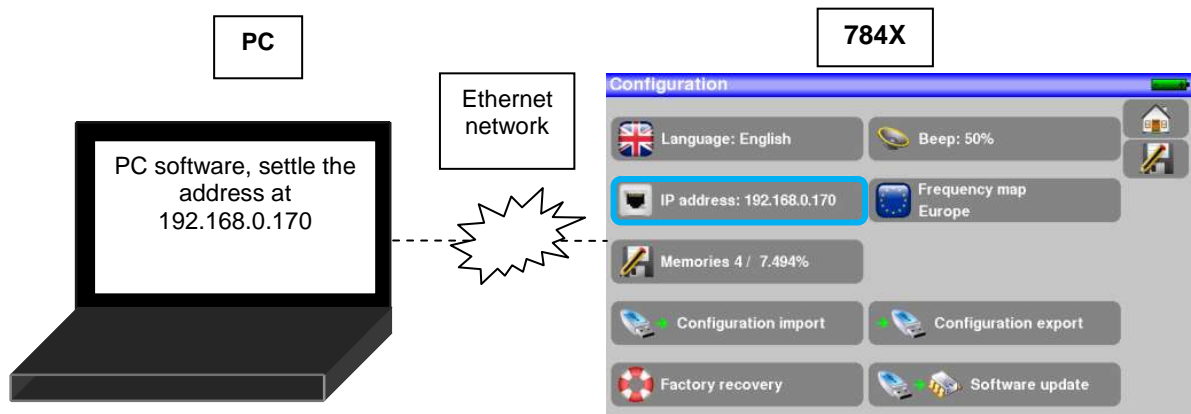



**Attention:** If the PC has already been connected to Ethernet (network, modem...), it is necessary to reboot the PC before connecting your appliance.

For the **Ethernet** connection of your appliance to a computer network, see the following scheme:

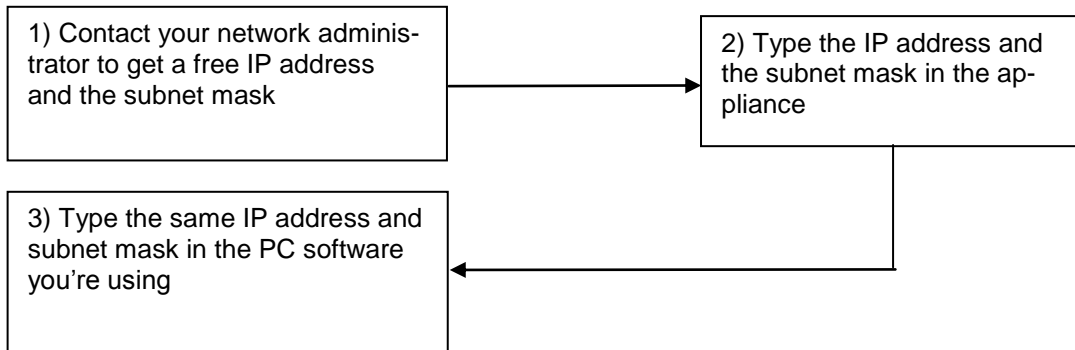

## 23 Displayed messages

The appliance may display messages while working.

### 23.1 Alert messages

Low battery: the appliance is about to shut off in a few minutes.



Confirmation request for an important action.



Remote power supply issue: voltage already present or maximum current exceeded.



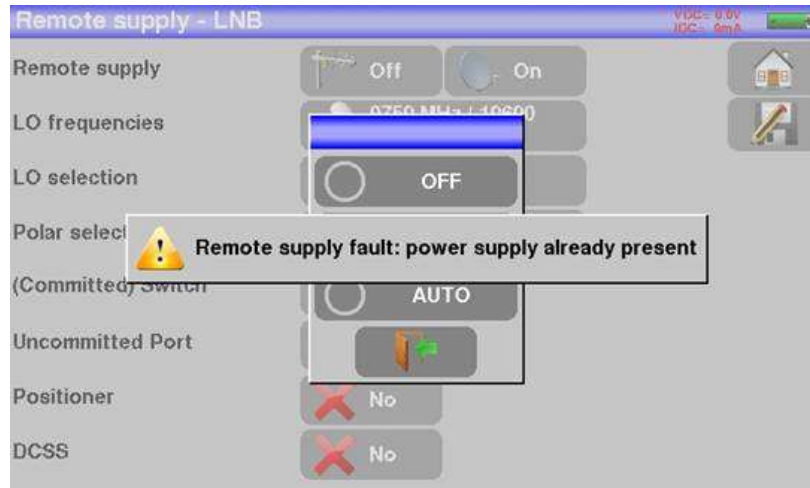

Messages of the same kind may show up; the pop up window is an alert; the corresponding message explains the issue.

## 23.2 Error messages

A message may show up at the bottom of the screen immediately after updating the software. Do not take it into account as far as it does not show up at a second start-up.

Else, or for any other problem, contact the **SEFRAM** technical support:

- **e-mail** : [support@sefram.fr](mailto:support@sefram.fr)
- **Téléphone** : 04 77 59 01 01



## 24 Maintenance

This appliance requires some maintenance to meet its requirements and maintain its general characteristics.

	Consequences	Recommended periodicity of controls	Recommended use limit
BATTERY	Reduction of the battery life		200 charge / discharge cycles or 2 years
STRAPS	Breakdown	At each use Check the holding of the straps	
Back Light SCREEN	Reduction of visibility		1 year
Measurement setting / check	Erroneous measures	Once a year	12 months
CONNECTIONS	Erroneous measures	At any measurement	

This "advice" does not engage the responsibility of SEFRAM I.S.

It guarantees the best possible use of the characteristics and the preservation of the product.

### Routine maintenance:

The basic maintenance is simply cleaning the outside of the appliance. Any other operation requires a trained personal.

Unplug the appliance before any intervention.

Do not let water flow inside the appliance: risk of electric shock.

### **Regularly clean the appliance under the following conditions:**

- use soapy water
- never use any product containing petrol, benzene, alcohols that would attack silkscreen printings
- wipe out with a soft lint-free cloth
- use a solvent-free antistatic product to clean the screen.

### **RF socket :**

- Make sure there are **no specks of copper between the weight and the mass.**
- Replace periodically the adapter F/F, an adapter in poor condition distorts all the measures.

## INFORMATION ABOUT THE LCD COLOR SCREEN WITH ACTIVE MATRIX

Your SEFRAM field strength meter is equipped with a LCD color screen with active matrix.

This screen is provided by renowned manufacturers. In the current technical conditions of manufacture, they cannot guarantee 100% good functioning pixels in the display zone. They specify a number of possible defective pixels at the surface of the screen.

The SEFRAM quality service has preconditioned the mounting of the screen on your instrument to the respect of the acceptance conditions of the manufacturers.

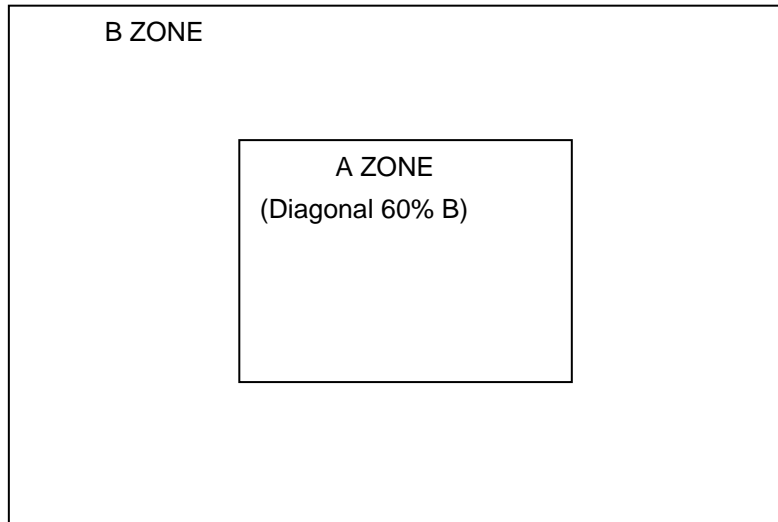

Acceptance criteria:

Zone A (central zone): total less than 5 defective pixels, less than 3 contiguous pixels.

Zone B (total surface of the screen): less than 9 defective pixels on the whole surface of the screen, with respect of the conditions prevailing in zone A.

Is considered as defective any pixel on screen that does not light up or lights up in a different color as expected.

The contractual guarantee on your field strength measurer can be exerted only if these criteria are not met, as well at delivery as during the period of guarantee.

# 25 Technical specifications

## 25.1 Technical specifications

Technical specifications	Terrestrial band	Satellite band
<b>Frequencies</b>		
Range	5-900 MHz	900-2200 MHz
Resolution	measure 50 kHz, display 1 kHz	measure 1MHz, display 1MHz
<b>Level measurements</b>		
Dynamic range	20-120 dBµV (30-120 dBµV for 5-45MHz)	30-110 dBµV
Noise floor level	10 dBµV typical	20 dBµV typical
Units	dBµV	
Accuracy	±2dB +/- 0.05dB/°C	
Resolution	0,1dB	
Measurement Filters	100KHz - 300 kHz - 1MHz	1MHz - 3MHz - 10MHz
Standards	DVB-C/C2, DVB-T/T2/T2lite BG, DK, I, L, MN, carrier	DVB-S/S2, DSS PAL, SECAM, NTSC
Mesures	RF level/power, C/N	
<b>Spectrum Analyser</b>		
Fast Mode	350 ms typ. (3 times/s)	
Filters (according to span)	100kHz, 300kHz, 1 MHz	1MHz - 3MHz - 10MHz
Attenuator	automatic or manual (0 to 55 dB with 5 dB step)	
Dynamic range (display)	60 dB (10 dB/div)	
Span	5MHz à full span 1, 2, 5 step	
<b>Pre-echos /Echos DVBT/T2</b>		
Dynamic range	DVB-T : 50 dB, -75km +75km ( 8k) DVB-T2 : 50 dB, -75km +75km ( 8k) DVB-C2 : 50 dB, -35km +35km (4k)	
Units	µs, km, miles	
<b>Constellation display</b>		
	yes, standards DVB-T/T2, DVB-C/C2, DVB-S/S2, DSS	
<b>Measurement Map</b>		
Capacity	scanning of 50 setups maximum	
Display	Texte table	
<b>TV MPEG</b>		
Digital Multiplex (not coded)	MPEG2 SD (définition standard) MPEG4 HD (haute définition H.264)	
Service table DVB-SI	SDT, LCN	
Sound	MPEG-1, MPEG-2, AAC, HE AAC, Dolby® Digital, Dolby® Digital Plus	

## 25.2 Digital measurements

DVB-T/H	
Bit Error Rate (BER)	CBER (before Viterbi BERi) VBER (after Viterbi BERo) UNC (lost packets PER) Noise margin
Modulation Error Rate(MER)	5 - 35dB
Bandwidth	6MHz, 7 MHz, 8 MHz
FFT type	2k, 8k, auto
Constellation	QPSK, 16QAM, 64QAM, auto
Viterbi rate	1/2, 2/3, 3/4, 5/6, 7/8, auto
Guard interval	auto, manual
Spectrum inversion	auto
HP/LP – PLP – Data Slice	HP/LP
Standards	ETS 300-744

DVB-T2 / T2 Lite	
Bit Error Rate (BER)	LDPC (BERi) BCH (BERo) FER (frame error PER) Noise margin
Modulation Error Rate(MER)	5 - 35dB
Bandwidth	1.7MHz, 5MHz, 6MHz, 7 MHz, 8 MHz
Mode	SISO, MISO, PLP single or multiple
FFT type	1k, 2k, 4k, 8k, 16k, 32k + extended bandwidth, auto
Constellation	QPSK, 16QAM, 64QAM, 256QAM, auto
Viterbi rate	1/2, 3/5, 2/3, 3/4, 4/5, 5/6, 1/3, 2/5, auto
Guard Interval	auto
Spectrum inversion	auto
HP/LP – PLP – Data Slice	PLP
Standards	ETS 302-755

DVB-C J83A	
Bit Error Rate (BER)	BER (before Reed Solomon BERo) UNC (lost packets PER) Noise margin
Modulation Error Rate(MER)	20 - 40dB
Symbol Rate	1 to 7.224 Ms/s
Constellation	16QAM, 32QAM, 64QAM, 128QAM, 256QAM
Spectrum inversion	auto
Standards	ETS 300-429

DVB-C2	
Bit Error Rate (BER)	LDPC (BERi) BCH (BERo) FER (frame error PER) Noise margin
Modulation Error Rate(MER)	5 - 35dB
Symbole rate	-
Bandwidth	6MHz, 8 MHz
Mode	PLP and data slice, single or multiple
FFT type	4k
Constellation	16QAM, 64QAM, 256QAM, 1024QAM, 4096QAM, auto
Viterbi rate	2/3, 3/4, 4/5, 5/6, 8/9, 9/10

Guard interval	auto
Spectrum inversion	auto
HP/LP – PLP – Data Slice	PLP+Data Slice
Standards	ETS 302-769

DVB-S, DSS	
Bit Error Rate (BER)	CBER (before Viterbi BERi) VBER (after Viterbi BERo) UNC (lost packets PER) Link margin
Modulation Error Rate(MER)	0 - 20dB
Symbol rate	1 to 45Ms/s
Constellation	QPSK
Viterbi rate	1/2, 2/3, 3/4, 5/6, 6/7, 7/8, auto
Spectrum inversion	auto
Standards	ETS 300-421

DVB-S2	
Bit Error Rate (BER)	LDPC (BERi) BCH (BERo) PER Link margin
Modulation Error Rate(MER)	0 - 20dB
Symbol rate	1 to 45Ms/s
Constellation	QPSK, 8PSK, 16APSK, 32APSK
Modulation	CCM, VCM, ACM
Multistream	stream select ISI 0-99, PL scrambling (Gold code)
Viterbi rate	2/5, 1/2, 3/5, 2/3, 3/4, 5/6, 8/9, 9/10, auto
Spectrum inversion	auto
Standards	ETS 302-307

## 25.3 Divers

Remote supply	Terrestrial	Satellite
Voltage	5V/13V/18 V/24V 500 mA max (300mA for 24V)	13/18 V 500 mA max
DiSEqC	-	DiSEqC 1.2 control of dish motor switches committed & uncommitted
Mini DiSEqC (22kHz)	-	22 kHz, ToneBurst
SCD /SATCR EN 50494 Single cable satellite distribution	-	8 slots max switch committed
SCD2 EN 50607 Single cable satellite distribution v2	-	32 slots max switchs committed & uncommitted code PIN

Storage	
Memory	Internal on non-volatile memory, or external USB stick (not supplied)
Data saved	measurements (level, BER/MER, Measurement Maps, Spectrum,...)
Capacity	512 Ko (about 150 files)

Inputs / Outputs	
RF input	75 Ohms, F (with adaptor)
Max permitted voltage	48V RMS / 50Hz
Interfaces	USB A, USB mini B, Ethernet 10baseT (RJ45)
DC supply input	jack 5.5 mm 15 V max, 5 A max

## 25.4 General specifications

Display	LCD TFT 7 inch color 16/9, luminosity backlight 500 cd/m <sup>2</sup> , 800x480 dots Touch capacitive
External supply	Main adaptor 110/230 VAC, with 5,5mm jack, 15 V 1 A
Battery	Batterie Li-ion 25W
Autonomy	2 hours typical, depending of use
Charging time	1,5 hour for 80% of capacity
Operating temperature	-5°C to 45°C
Storage temperature	-10°C to 60°C
EMC and safety	NF EN 61326-1(2013) et NF EN 61326-2-1(2013) (class B, basic electromagnetic environment) / NF EN 61010
Dimensions	250 x 165 x 65 mm
Weight	1,350 kg

## 25.5 Accessories

**Supplied with:** main adaptor, user's manual (CD-ROM), F/F adaptor, protective pouch (mounted) with belt and clip, transportation bag.

Optional accessories:

- Car cigar lighter adaptor: ref. 978361000
- Carrying bag 784X/781X: ref. 978481000
- Luxury backpack réf. 978751000
- Sun protector + Rain protector + coat hook ref. 978489000
- Rain protector réf. 978489500

**Contact our sales department SEFRAM.**

**04 77 59 01 01**

## 25.6 V, dBμV, dBmV et dBm conversion

dBμV (dBmV) is a logarithmic ratio between a measured voltage  $U_d$  and a reference voltage  $U_r$ .

The reference voltage is  $U_r = 1 \mu\text{V}$  (1 mV)

$$N = 20 \log (U_d/U_r)$$

dBm is a logarithmic ratio between a measured power  $P_d$  and a reference power  $P_r$ .

The reference power is  $P_r = 1 \text{ mW}$  into 75 ohms.

$$N = 10 \log (P_d/P_r) \text{ with } P_d = U_d^2 / 75$$

$U_d = 1 \mu\text{V}$	$N = 0 \text{ dB}\mu\text{V}$	$N = -60 \text{ dBmV}$	$N = -108.75 \text{ dBm}$
$U_d = 1 \text{ mV}$	$N = 60 \text{ dB}\mu\text{V}$	$N = 0 \text{ dBmV}$	$N = -48.75 \text{ dBm}$
$U_d = 1 \text{ V}$	$N = 120 \text{ dB}\mu\text{V}$	$N = 60 \text{ dBmV}$	$N = 11.25 \text{ dBm}$

## 25.7 Typical values for measurements

Values given are indicatives, minimum and maximum for good signal quality

Measurements	Level, power (dBμV)		C/N (dB)	BER	MER (dB)	modulation
	mini	maxi				
Terrestrial						
Analogue TV	57	74	> 45	-	-	-
FM	50	66	> 38	-	-	-
DAB/DAB+	35	70		$\text{BER} < 2^E-4$	-	2K
DVB-T/H	35	70	> 26	$\text{VBER} < 2^E-4$	> 26	8K, 64QAM, 1/32, 2/3
DVB-T2	35	70	> 22	$\text{FER} < 2^E-7$	> 22	32K, 256QAM, 1/8, 2/3
DVB-C	57	74	> 31	$\text{BER} < 2^E-4$	> 31	64QAM
Satellite						
Analogue TV	47	77	> 15	-	-	-
DVB-S, DSS	47	77	> 11	$\text{VBER} < 2^E-4$	> 11	QPSK, 3/4
DVB-S2	47	77	> 8	$\text{PER} < 1^E-7$	> 8	8PSK, 2/3



## 26 Terminology

### **2K/8K** : The number of carrier waves of the DTT channel

The **8K** mode (6817 carrier waves in the channel, including 6048 carrying useful data)

The **2K** mode (1705 carrier waves in the channel, including 1512 carrying useful data)

For the same purpose, the 8K mode allows the selection of a larger guard interval than the 2K mode, thus a better resistance to echoes

**SPECTRAL ANALYSIS** : Method used to highlight the characteristics of the signal. The interest of this analysis is to visualize the troublemakers as well as the shape of the signal. The spectrum analysis highlights the amplitude frequency characteristic.

**FREQUENCY BAND** : Continued portion of the frequency spectrum having made the object of a particular affectation (telecommunication, television, internal security...)

Exemple : UHF band → 470 to 860 MHz

**BCH** : Bose Chauhuri Houquenohe

Algorithm used to correct errors in transmissions of digital satellite DVB-S2 signals.

**BER** : Bit Error Rate

Calculation of the erroneous bits with regard to the number of transmitted bits. BER demonstrates the degradation of the digital information.

**TV PACKAGE** : Set of channels spread and marketed by a same operator (TPS, Cnal Satellite...)

**CHANNEL** : Assignment of a number to the transmission frequency of an audio video signal. TV channels receive numbers. Specific to each country.

Example : from 21 to 69 for the UHF band

canal 21 = frequency 471,25 MHz

**CELL ID**: Cell identification

Identification of the DVB-T emitter with 4 digits in hexadecimal format, which means 65536 possibilities.

**C/N** : Carrier to Noise ratio

A good C/N ratio helps the quality of the pictures on the TV screen. Ratio in dB.

Caution: You have to take the ratio analysis filter width / channel into account.

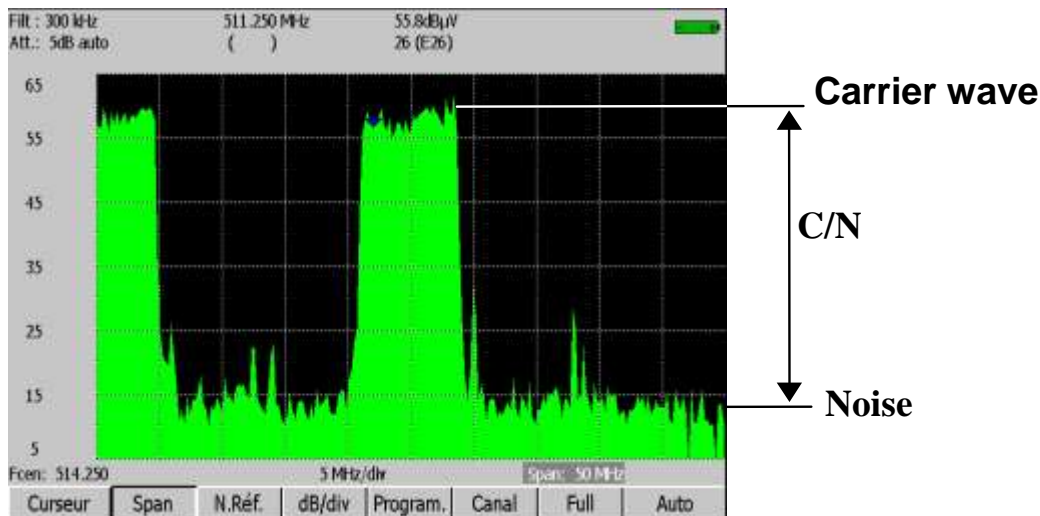

**COFDM**: Coded Orthogonal Frequency Division Multiplex.

Digital coding used for DTT. Its principle is to transmit information via many carrier waves (2K or 8K mode).

**CONSTITUTION** : Control mean for the quality of the signal by a group of points making spots on the screen of the field meter. **The more circular and distinct the spots of the constellation, the better the quality of the signal.**

In addition, according to the shape of the spots, you can evaluate the kind of error. This function is available on field meters that enable the display of the constellation for any type of digital signal QAM, QPSK and COFDM.

Typically:

- QAM (cable) : 64 spots (16 spots per quarter)
- COFDM (TNT) : 64 spots (16 spots per quarter)
- QPSK (Satellite) : 4 spots (1 spot per quarter)
- 8PSK (Satellite) : 8 spots (on a circle)

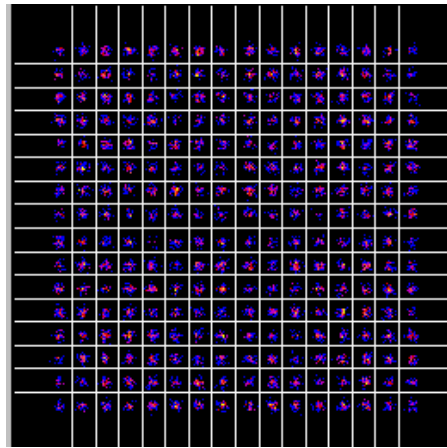
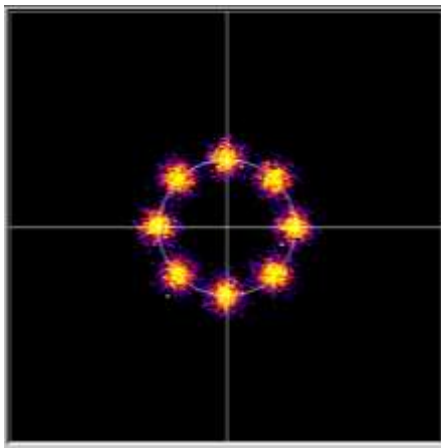

**COUNTER-POLARIZATION**: Ratio between the levels received from the desired polarization and the opposed polarization (it should be as high as possible). To adjust the counter-polarization, you have to turn the head of the dish.

**DAB**: Digital Audio Broadcasting.

The Digital Audio Broadcasting is a standardized audio broadcasting system (coded in COFDM).

It exists on the following bands:

L Band: 1452-1492Mhz

3 Band: 223-230Mhz

**DVB-T**: Broadcasting norm for the terrestrial digital television, COFDM modulation

**DVB-C**: Broadcasting norm for the cable digital television, QAM modulation

**DVB-C2**: Broadcasting norm for the cable digital television by cable (based on DVB-T2)

**DVB-S**: Broadcasting norm for the satellite digital television, QPSK modulation

**DVB-S2**: Broadcasting norm for the satellite digital television, QPSK or 8PSK modulation

**DISEqC**: Digital Satellite Equipement Control.

Control norm for the equipment of reception for satellite signals. Uses a 22kHz signal superimposed to the remote supply voltage of the satellite dish.

**FREQUENCY**: Parameter that characterizes the radio-electrical wave. It is measured in "Hertz". We

usually use

some multiples of this unit: kilohertz (kHz), megahertz (MHz), gigahertz (GHz).

ex.: At Saint Etienne (Guizay), the TF1 frequency is 583.25 MHz

**HPLP:** high/low priority → possibility to transmit 2 multiplexes under the same channel in digit format (ex.: in COFDM, we have a very robust high priority flow in QPSK; secondary flow in 16QAM)

**GUARD INTERVAL:** The guard interval is the time when the signal is not emitted: all signals carrying the same information but coming from different sources (various emitters or through multiple reflections) won't disturb each other.

Value for DTT: 1/32 (28µs), that permits echoes lower than 8.4km

**ISOFREQUENCY:** (or SFN: Single Frequency Network)

A DVB-T emitter network that emits on a whole region or a country at the same frequency.

→ risk of echoes outside the guard interval

→ moving reception

**LNB:** Low Noise Block-converter

A LNB (or universal head) is a standard converter for the analogical and digital reception of a satellite.

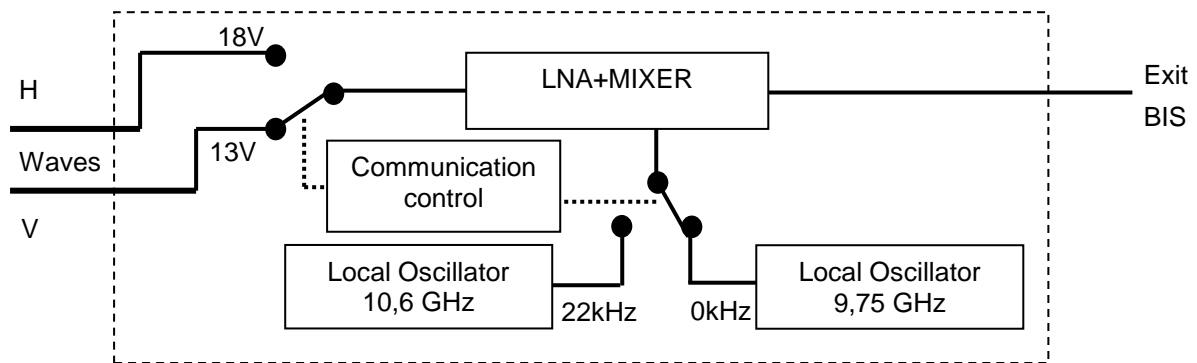

The reception is made on 2 low/high frequency band and 2 horizontal/vertical polarizations of the received wave.

The commutation of the band is made by a 13/18Volt voltage. The commutation of the polarization is made by a 22kHz signal superimposed to this voltage (you can also use the DiSEqC commutation for some LNB).

**LDPC:** Low Density Parity Checker

An algorithm used to correct errors in transmissions of digital satellite transmissions DVB-S2 signals.

**NOISE MARGIN:** Difference between the measured and the theoretical noise level before incorrigible errors.

Difference in dB between the measured C/N and the minimum C/N for error-free transmission.

**MER:** Modulation Error Ratio

Ratio in dB measuring the distance between the theoretical dot and the observed dot on a constellation quarter. You can use it to control the reception: **the higher this value, the better the image.**

 Error vector

 Magnitude vector (from the reference dot to the ideal dot)

**MODULATION:** Once the signal has been coded, it is modulated with a carrier wave for transmission.

AM (Amplitude Modulation): analogical modulation of the amplitude of the carrier wave

FM (Frequency Modulation): analogical modulation of the frequency of the carrier wave

QPSK (Quadrature Phase Shift Keying): phase digital modulation

QAM (Quadrature Amplitude Modulation): phase and amplitude digital modulation

COFDM (Coded Orthogonal Frequency Division Multiplex): phase and amplitude digital modulation on multiple carrier waves; for DTT.

**MPEG :** Motion Picture Expert Group

MPEG is a family of compressed digital coding formats for audio / video. The aim of MPEG coding is to hugely reduce the amount of transmitted information with as little loss as possible thanks to very complex compression algorithms.

The MPEG 2 option on the SEFRAM field meters allows you to view and control TV programs (coded under MPEG) directly on the meters.

ex.: On the Astra satellite, the EURONEWS and SPORT + channels are non-encrypted and visible on the field meters.

**MULTIPLEX :** Set of channels broadcasted by the same operator (smaller set than a package). In DTT, a multiplex has a 24.5Mbits/s flow rate. A multiplex enables the diffusion of 6 programs in standard definition

**NIT :** Network Information Table – Information about the network/package

Enables the display of a description of the measured transponder. The information is sent non-coded in the data flow from the QAM, COFDM or QPSK decoder. The information items are:

- Name of the operator
- List of the transponders of the package
- Orbital position of the satellite (in Satellite mode).

**OFFSET:** The central frequency of a DTT channel may be shifted by  $\pm 166.7$  kHz in case of adjacent analogical channel to prevent disturbances

**OL:** A local oscillator that converts the frequency received from the satellite, in GHz, into an intermediary frequency that the demodulator can use, in MHz.

ex.: a 11.778 GHz frequency from the satellite passing through a 10.6 GHz OL LNB becomes a  $11.778 - 10.600 = 1.178$  MHz

See LNB scheme.

**AUDIO AND VIDEOPID:** Packet Identifier. MPEG service information.

In the digital MPEG flow, the (audio or video) packets all include a PID to get binary data from each service.

**Frequency plan:** There are various Frequency Plans according to places and standards. In the SEFRAM

field meters, the frequency plans are pre-programmed: they gather the most frequently used frequency bands.

**Measure plan :** Allows the simultaneous view of characteristics (frequency, channel, standard...) of various programs (TF1, France2...) with location of measures except tolerance. Allows to carry out BER level measures, for a list of programs.

**PLP** : (Physical Layer Pipe) from 1 to 256 channels are available in DVB-T2 to transport independent multiplexes.

**POLARIZATION**: Polarization of a signal from the satellite. It can be either:

linearly polarized, horizontally or vertically:



Circularly polarized to the right or the left

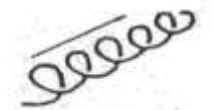

In ground reception, the polarization is generally horizontal (the stalks of antennas are horizontal). Some receptions in band VHF are in vertical polarization (Canal+). In this case, the stalks of the antenna are vertical.

**POSITIONER**: A motorized system for the rotation of a satellite dish. Positioners are operated by DiSEqC commands

**QAM** : Quadrature Amplitude Modulation.

This kind of modulation is used for digital transmissions (cable networks and DTT).

**QPSK**: Quadrature Phase Shift Keying (or 4PSK)

A kind of modulation mostly used for satellites.

**8PSK** : A type of modulation identical to QPSK, but with an 8-possibility (3-bit) coding. This kind of modulation enables higher rates than QPSK and is compatible with DVB-S2.

**REED-SOLOMON** : An algorithm used to correct errors in digital transmissions

**STANDARD** : Any norm that defines the characteristics of a modulation.

Analogical standards: L, BG, DK, etc.

Digital standards:

QAM for **cable television**

QPSK, 8PSK for **satellite television**

COFDM for **terrestrial digital television**

**T-DMB** : A digital broadcasting system based on the DAB.

This very robust broadcasting mode for mobile applications thanks to the modulation used (DQPSK=differential QPSK). Allows the reception of digital television but also of television programs on small-size appliances like mobile telephones or PDA

**TOP DE SYNCHRO** : Signal carré indiquant le début d'une trame ou d'une ligne.

**TVHD** : Télévision Haute Définition

En télévision standard, le nombre de lignes composant l'image va de 480(NTSC) à 576 (PAL et SECAM). Chaque ligne comprend 720 pixels. Pour comparer à l'informatique, un téléviseur correspond à une résolution SVGA 800 x 600. La proportion de l'image est de 4/3 (rapport largeur / hauteur).

En télévision HD, l'image est constituée de 1080 lignes, chacune constituée de 1920 pixels – soit un équivalent de 2M pixels.

Les téléviseurs HD ready ont une résolution minimale de 1280 par 720

Les téléviseurs Full HD ont une résolution minimale de 1920 par 1080

**UNC** : un-corrected packets

**VIACCESS - MEDIAGUARD** : Decryption systems used in Europe by many operators (TPS, Canal Satellite...).

With the Viaccess and Mediaguard options in a SEFRAM field meter and your subscription card, you will be able to view encrypted programs on the meter.

**VITERBI** : An algorithm used to correct errors in digital transmissions

## 27 CE Declaration

### DECLARATION OF CE CONFORMITY

according to EEC directives and NF EN 45014 norm

**DECLARATION DE CONFORMITE CE**

*suivant directives CEE et norme NF EN 45014*



**SEFRAM INSTRUMENTS & SYSTEMES**  
32, rue Edouard MARTEL  
42009 SAINT-ETIENNE Cedex 2 ( FRANCE)

**Declares, that the below mentioned product complies with :**

*Déclare que le produit désigné ci-après est conforme à :*

**The European low voltage directive 2006/95/EEC :**

*La directive Européenne basse tension 2006/95/CE*

**NF EN 61010-1 Safety requirements for electrical equipment for measurement, control and laboratory use.** Règles de sécurité pour les appareils électriques de mesurage, de régulation et de laboratoire.

**The European EMC directive 2004/108/EEC :**

**Emission standard EN 61326-1 (2013) + EN 61326-2-1 (2013).**

**Immunity standard EN 61326-1(2013) + EN 61326-2-1 (2013).**

**Standards used: EN 55011 (2009 + A1/2010) ; EN 61000-4-2 (2009) ; EN 61000-4-3 (2006+A1/2008+A2/2010) ; EN 61000-4-4 (2012) ; EN 61000-4-5 (2006) ; EN 61000-4-6 (2009)**

*La directive Européenne CEM 2004/108/CE :*

*Emission standard EN 61326-1 (2013) + EN 61326-2-1 (2013).*

*Immunity standard EN 61326-1(2013) + EN 61326-2-1 (2013).*

*Normes utilisées : EN 55011 (2009 + A1/2010) ; EN 61000-4-2 (2009) ; EN 61000-4-3 (2006+A1/2008+A2/2010) ; EN 61000-4-4 (2012) ; EN 61000-4-5 (2006) ; EN 61000-4-6 (2009)*

**Product name Désignation : Field Strength Meter Mesureur de champ**

**Model Type : 7817,7848, 7849**

**Compliance was demonstrated in listed laboratory and record in test report number**

*La conformité à été démontrée dans un laboratoire reconnu et enregistrée dans le rapport numéro* **RC 7848**

**SAINT-ETIENNE the :**

**September 30, 2015**

**Name/Position :**

**CLERJON/ Quality Manager**