

BK PRECISION®

Model: 894/895

500 KHz/1 MHz LCR Meter

PROGRAMMING MANUAL



Table of Contents

	Remote Operation.....	6
1.	1.1 Interface Configuration.....	6
	<i>RS-232C</i>	6
	<i>USB (USBCDC - Virtual COM)</i>	7
	<i>USBTMC</i>	7
	<i>LAN (Ethernet)</i>	7
	<i>GPIB (895 Only)</i>	8
	Command Reference	9
2.	2.1 IEEE488.2 Common Commands.....	9
	<i>*RST</i>	9
	<i>*TRG</i>	9
	<i>*CLS</i>	9
	<i>*IDN?</i>	9
	<i>*TST?</i>	10
	<i>*ESE</i>	10
	<i>*SRE</i>	10
	<i>*ESR</i>	11
	<i>*STB?</i>	11
	<i>*OPC</i>	12
	2.2 Subsystem commands for 894/895	12
	2.3 DISPlay subsystem commands.....	13
	<i>DISP:PAGE</i>	14
	<i>DISP:LINE</i>	14
	<i>DISPlay:RFont </i>	15
	2.4 FREQuency subsystem commands	15
	<i>FREQ</i>	15
	2.5 VOLTage subsystem commands	16
	<i>VOLT</i>	16
	<i>CURRent</i>	16
	2.6 AMPLitude Subsystem Commands.....	16
	<i>AMPL</i>	16

2.7	Output RESister subsystem commands	17
	<i>ORES</i>	17
2.8	OUTPut subsystem commands	17
	<i>OUTPut:DC:ISOLation</i>	17
2.9	BIAS subsystem commands	17
	<i>BIAS:STAtE</i>	18
	<i>BIAS:VOLTAGE</i>	18
	<i>BIAS:CURRent</i>	19
2.10	FUNcTion subsystem commands	19
	<i>FUNcTion:IMPedance</i>	21
	<i>FUNcTion:IMPedance:RANGe</i>	21
	<i>FUNcTion:IMPedance:RANGe:AUTO</i>	22
	<i>FUNcTion:Source MONitor:VAC</i>	22
	<i>FUNcTion:SMONitor:IAC</i>	22
	<i>FUNcTion:DEV<n>:MODE</i>	22
	<i>FUNcTion:DEV<n>:REFerence<value></i>	23
	<i>FUNcTion:DEV<n>:REFerence:FILL</i>	23
2.11	LIST subsystem commands	24
	<i>LIST:FREQuency</i>	24
	<i>LIST:VOLTage</i>	25
	<i>This</i>	25
	<i>LIST:CURRent</i>	25
	<i>This</i>	25
	<i>LIST:BIAS:VOLTage</i>	26
	<i>This</i>	26
	<i>LIST:BIAS:CURRent</i>	26
	<i>This</i>	26
	<i>LIST:MODE</i>	27
	<i>LIST:BAND</i>	27
	<i>LIST:CLEAr:ALL</i>	27
2.12	APERture subsystem commands	28
	<i>APERture</i>	28
2.13	TRIGger subsystem commands	28

<i>TRIGger</i>	29
<i>TRIGger:SOURce</i>	29
<i>TRIGger:DELAy</i>	29
2.14 FETCh? Subsystem Commands	30
<i>FETCh</i>	30
2.15 CORRection subsystem commands	32
<i>CORRection:LENGth</i>	33
<i>CORRection:METhod</i>	34
<i>CORRection:OPEN</i>	34
<i>CORRection:OPEN:STATe</i>	35
<i>CORRection:SHORT:STATe</i>	35
<i>CORRection:LOAD:STATe</i>	35
The <i>CORRection:LOAD:TYPE</i>	35
<i>CORRection:SPOT<n>:STATe</i>	36
<i>CORRection:SPOT<n>:FREQUency</i>	37
<i>CORRection:SPOT<n>:OPEN</i>	37
<i>CORRection:SPOT<n>:SHORT</i>	37
<i>CORRection:SPOT<n>:LOAD:STANdard</i>	37
<i>CORRection:USE:DATA?</i>	38
<i>CORRection:CLEAr</i>	39
2.16 COMParator subsystem commands	39
<i>COMParator[STATe]</i>	40
<i>COMParator:MODE</i>	40
<i>COMParator:TOLerance:NOMinal</i>	40
<i>COMParator:TOLerance:BIN<n></i>	41
<i>COMParator:SEQUence:BIN</i>	41
<i>COMParator:SecondaryLIMit</i>	41
<i>COMParator:Auxiliary BIN</i>	42
<i>COMParator:SWAP</i>	42
<i>COMParator:BIN:CLEAr</i>	42
<i>COMParator:BIN:COUNT</i>	43
<i>COMParator:BIN:COUNT:DATA?</i>	43
<i>COMParator:BIN:COUNT:CLEAr</i>	43

2.17 Mass MEMory subsystem commands	43
<i>MMEMory:LOAD:STATe</i>	44
<i>MMEMory:STORe:STATe</i>	44

Remote Operation

The instrument comes with RS232C, USB (virtual COM), LAN, and GPIB (895 only) interfaces for remote control. This chapter will describe how users can remotely operate the instrument and use SCPI (Standard Commands for Programmable Instruments) commands over any one of these remote interfaces.

1.1 Interface Configuration

RS-232C

For RS-232C connectivity, refer to the diagram below for pinout information. The RS-232C is labeled in the rear panel and it is a female DB-9 interface. Use a crossover cable where pins 2 and 3 are reversed.

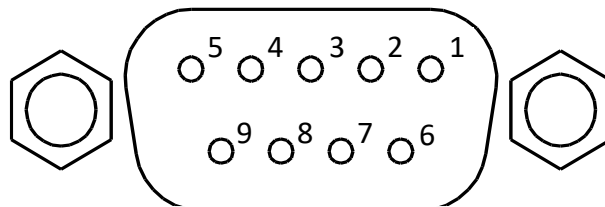

PIN	Description
1	-
2	Transmit Data
3	Receive Data
4	-
5	GND
6	-
7	CTS
8	RTS
9	-

Parameter	Description
Baud rate	9600, 19200, 28800, 38400, 48000, 57600, and 115200.

Parity and data bit	None/8 bits, Even/8 bits, Odd/8 bits
Stop bit	1, 2
Flow control	None

Table 1 - RS-232C Settings

NOTICE

The RS-232C interface does not support hardware flow control (only transmit, receive, and ground pins are used). The programmer should be aware of this limitation and notice the command process time of the LCR meter. If the remote commands are sent too fast to the LCR meter, the internal buffer may overrun and cause a communication error. Therefore, adding a delay between commands is necessary to allow time for the meter to process.

USB (USBCDC - Virtual COM)

The standard USB port is a virtual COM port that can be used for remote communication. There are no settings in the menu system for USB configuration. The serial settings are the same as the settings for RS-232C.

NOTICE

The USB interface does not support hardware flow control (only transmit, receive, and ground pins are used). The programmer should be aware of this limitation and notice the command process time of the LCR meter. If the remote commands are sent too fast to the LCR meter, the internal buffer may overrun and cause a communication error. Therefore, adding a delay between commands is necessary to allow time for the meter to process.

USBTMC

USB The standard USB port is a USBTMC-compliant port that can be used for remote communication. There are no additional settings in the menu system for USB configuration. The only requirement is that NI-VISA is installed on the computer, which can be downloaded at <http://www.ni.com/visa/>.

LAN (Ethernet)

The 894/895 can also be controlled via LAN interface. Refer to the user manual for setup information.

GPIB (895 Only)

The GPIB address of the LCR meter can be configured from 1-31. To communicate via GPIB, connect a GPIB cable to the GPIB port at the back of the LCR meter.

Command Reference

The SCPI interface enables users to operate the power supply through a computer or a terminal equipped with IEEE-488.2 GPIB, RS-232, or USB interface.

The following table lists all of the numerical parameters:
2.

Symbol	Response Formats
NR1	integer, e.g.:123
NR2	fix-point number, e.g.: 12.3
NR3	floating-point number, e.g.: 12.3E+5
NL	Carriage return key, ASCII code: 10
^END	EOI signal in IEEE-488. EOI gets asserted on the GPIB interface.

2.1 IEEE488.2 Common Commands

***RST**

The *RST command resets the instrument.

Command syntax: *RST

***TRG**

The *TRG command triggers the measurement and then sends the result to the output buffer.

Command syntax: *TRG

***CLS**

The *CLS command clears the standard event status register and the service request status register.

Command syntax: *CLS

***IDN?**

The *IDN? query returns the instrument's ID.

Query syntax: *IDN?

Return format: *<manufacturer>*,*<model>*,*<SN>*,*<firmware>*,*<HW_version>* *<NL^END>*

Where,

<manufacturer> Name of Manufacturer (B&K Precision)

<model> Instrument Model (895)

<SN> XX-XXX-XXXXX
<firmware> Firmware Version (VER1.0.0)
<HW_version> Hardware Version (Hardware Ver XX.X)

***TST?**

The *TST? query executes an internal self test and returns the test result as the sum of all existing errors codes. If there are no error 894/895 returns 0.

Query syntax: *TST?

Return format: <NR1><NL^END>

***ESE**

The *ESE (standard Event Status Enable command) command sets each open bit of the standard event status register. This command returns setups of each open bit for the standard event status permission register.

Command syntax: *ESE<value>

Query syntax: *ESE?

Return format: <value><NL^END>

Where, <value> NR1 format: decimal number for each bit of operation status register.

Descriptions for each byte of the standard event status register are shown as follows:

Bit number	Description
7	Power On(PON) Bit
6	User Request(URQ) Bit
5	Command Error(EME) Bit
4	Execution Error(EXE) Bit
3	Device Dependent Error(DDE) Bit
2	Query Error(QYE) Bit
1	Request Control(RQC) Bit
0	Operation Complete(OPC) Bit

***SRE**

The *SRE (Service Request Enable command) command sets each open bit of the service status byte register. This command returns the current setups for each open bit of the status byte permission register.

Command syntax: *SRE<value>

Query syntax: *SRE?

Return format: <value><NL^END>

Where, <value> NR1 format: decimal expression for each permission bit of the status byte register.

Descriptions for each byte of the status byte register are shown as follows:

Bit number	Description
7	Operation Status Register Summary Bit
6	RQS(Request Service) Bit
5	Standard Event Status Register Summary Bit
4	MAV(Message Available) Bit
3-0	Always 0(zero):

***ESR**

The *ESR? query returns the contents of the standard event status register.

Query syntax: *ESR?

Return format: <value><NL^END>

Where, <value> NR1 format: decimal expression for contents of the standard event status register.

Descriptions for each bit of the standard event status register

Bit number	Description
7	Power On(PON) Bit
6	User Request(URQ) Bit
5	Command Error(EME) Bit
4	Execution Error(EXE) Bit
3	Device Dependent Error(DDE) Bit
2	Query Error(QYE) Bit
1	Request Control(RQC) Bit
0	Operation Complete(OPC) Bit

***STB?**

The *STB? query returns contents of the standard service status byte register. The execution of this command will not affect contents of the standard status byte register.

Query syntax: *STB?

Return format: <value><NL^END>

Where, <value> NR1 format: decimal expression for contents of the standard status byte register.

Descriptions for each bit of the standard status byte register:

Bit number	Description
7	Operation Status Register Summary Bit
6	RQS(Request Service) Bit
5	Standard Event Status Register Summary Bit
4	MAV(Message Available) Bit
3-0	Always 0(zero)

***OPC**

The *OPC command equals to set the OPC bit of the standard event status register when 894/895 finishes all parameter measurements. Ever since all pending operations have been completed, this command will inform the instrument to add a ASCII number "1" (number: 49) into the output buffer.

Command syntax: *OPC

For example: OUTPUT 717; *"*OPC"* Sets the OPC bit of the instrument when the last command is done.

Query syntax: *OPC?

Return format: 1<NL^END>

2.2 Subsystem commands for 894/895

Find below a list of the subsystem commands for the LCR meter. For SCPI commands, there is a short and long form. In the list below, find the short version in bold and in capital letters, the long version of the command is the entire word.

Short Version	Long Version
DISP	DIS Play
FREQ	FRE Quency
VOLT	VOLT age
CURR	CURR ent
AMPL	AMPL itude
ORES	Out put RES istance
OUTP	OUTP ut
BIAS	BIAS
FUNC	FUN Ction
LIST	LIST
APER	APER ture
TRIG	TRIG ger
FETC	FET Ch?
CORR	CORR ection

COMP	COM parator
MMEM	Mass MEM ory

2.3 *DISPlay subsystem commands*

The command tree for the Display Subsystem is as follows:

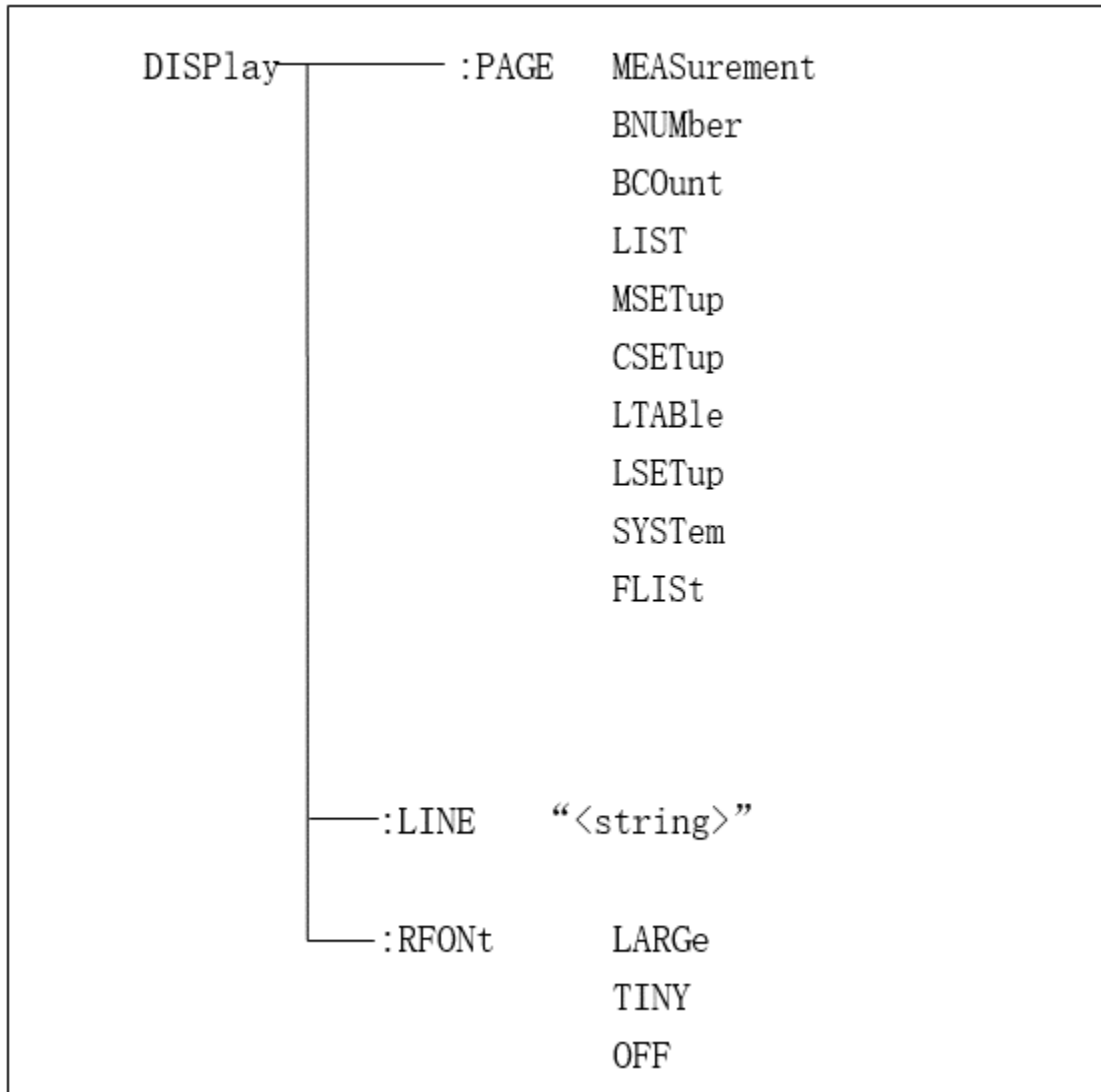

DISP:PAGE

DISP:PAGE subsystem commands are used to configure the display pages of the instrument.

Command Syntax	DISPlay:PAGE<page name>
Query syntax	DISPlay:PAGE? Query returns the current page.
Return format	<page name><NL^END>
Example 1	DISP:PAGE MEAS Set the display page as the LCR measurement display page.
Example 2	DISP:PAGE? Returns: MEAS DISP

Where <Page name> can be set as the following items:

Page name	Function
MEASurement	Set the display page as the LCR measurement display.
BNUmber	Set the display page as the bin number display.
BCOunt	Set the display page as the bin count display.
LIST	Set the display page as the list sweep display.
MSEtup	Set the display page as the measurement display.
CSEtup	Set the display page as the correction setup.
LTABle	Set the display page as the limit table setup.
LSEtup	Set the display page as the list sweep setup.
SYSTem	Set the display page as the system setup page.
FLISt	Set the display page as the file list page.

DISP:LINE

The DISP:LINE command is used to enter comments containing up to 16 ASCII characters in the comment field. The string "BK89xATS" is displayed if this is empty.

Command Syntax	DISPlay:LINE "<string>"
Query syntax	DISPlay:LINE?

Return format Return format: <string><NL^END>
Example 1 DISP:LINE "ResistanceValues"
Assigns a representative name to the string.
Example 2 DISP:LINE?
Returns:
ResistanceValues

Where <string> can be an ASCII character string (maximum number is 16).

DISPlay:RFONt

The ResultFONT command is used to set the current font of the measurement result on the <MEAS DISPLAY> PAGE.

Command Syntax DISPlay:RFONt
Query syntax DISPlay:ResultFONT?
Return format Return format: <NL^END>

Where can be any of the following options:

Item	Function
LARGE	Use large character to display the measurement result, 12ms/meas.
TINY	Use tiny character to display the measurement result, 5ms/meas.
OFF	Measurement result will not be displayed but can be read from the bus.

2.4 FREQuency subsystem commands

FREQ

Sets the measurement frequency of the instrument.
Returns the measurement frequency being used to do measurements.

Command Syntax FREQuency <value>
Query syntax FREQuency?
Return format <NR3><NL^END>
Example FREQ 1MHZ

Where <value> can be: NR1, NR2 or NR3 (followed by Hz, kHz, MHz), MIN or MAX.
MIN= Set the measurement frequency as 20Hz.
MAX= Set the measurement frequency as 500 KHz for the 894 or 1 MHz for the 895.

2.5 VOLTage subsystem commands

VOLT

The VOLTage subsystem commands are used to set and query the measurement voltage level.

Command Syntax	VOLTage <value>
Query syntax	VOLTage?
Return format	<NR3><NL^END>
Example	VOLT 0.500 V Sets measurement voltage level to 500 mV.

Where <value> can be: NR1, NR2 or NR3 data format followed by V.

MIN= Set the measurement voltage as 5mV.

MAX= Set the measurement voltage as 2V.

CURRent subsystem commands

CURRent

The CURRent subsystem commands are used to set and query the current level for the measurement signal.

Command Syntax	CURRent <value>
Query syntax	CURRent?
Return format	<NR3><NL^END>
Example 1	CURR 10MA Sets the current level for the measurement signal to 10 mA.

Where <value> NR1, NR2 or NR3 data format followed by MA.

MIN Set the measurement current as 50 μ A.

MAX Set the measurement current as 66.67mA.

MIN and MAX value changes depending on impedance range.

2.6 AMPLitude Subsystem Commands

AMPL

The AMPLitude subsystem commands are mainly used to set the auto level control (ALC) function.

Command Syntax	AMPL:ALC <status>
Query syntax	AMPLitude:ALC?
Return format	<NR1><NL^END>

Example 1 AMPL:ALC ON

Turn function Auto Level Control (ALC) on.

Where <status> can be: 0 or OFF, or 1 or ON

2.7 Output RESister subsystem commands

ORES

The Output RESister subsystem commands are used to set the output impedance of the LCR meter.

Command Syntax ORESister <impedance>

Query syntax ORESister?

Return format <NR1><NL^END>

Example 1 ORES 30

Set the output internal resistance is 30 OHM.

Where <impedance> can be either 30, 50 or 100.

2.8 OUTPut subsystem commands

OUTPut:DC:ISOLation

The OUTPut subsystem commands are used to set the Bias Current Isolation function of the 50mA/5V DC bias source as ON or OFF.

Command Syntax OUTPut:DC:ISOLation <status>

Query syntax OUTPut:DC:ISOLation?

Return format <NR1><NL^END>

Example 1 OUTP:DC:ISOL 1

Turns the Bias Current Isolation function on.

Example OUTP:DC:ISOL OFF

Turns the Bias Current Isolation function off.

Where <status> can be: 0 or OFF, or 1 or ON.

2.9 BIAS subsystem commands

The BIAS subsystem command are used to set the status of the DC Bias Function (on/off), bias voltage, and bias current.

Refer to the image below for command tree:

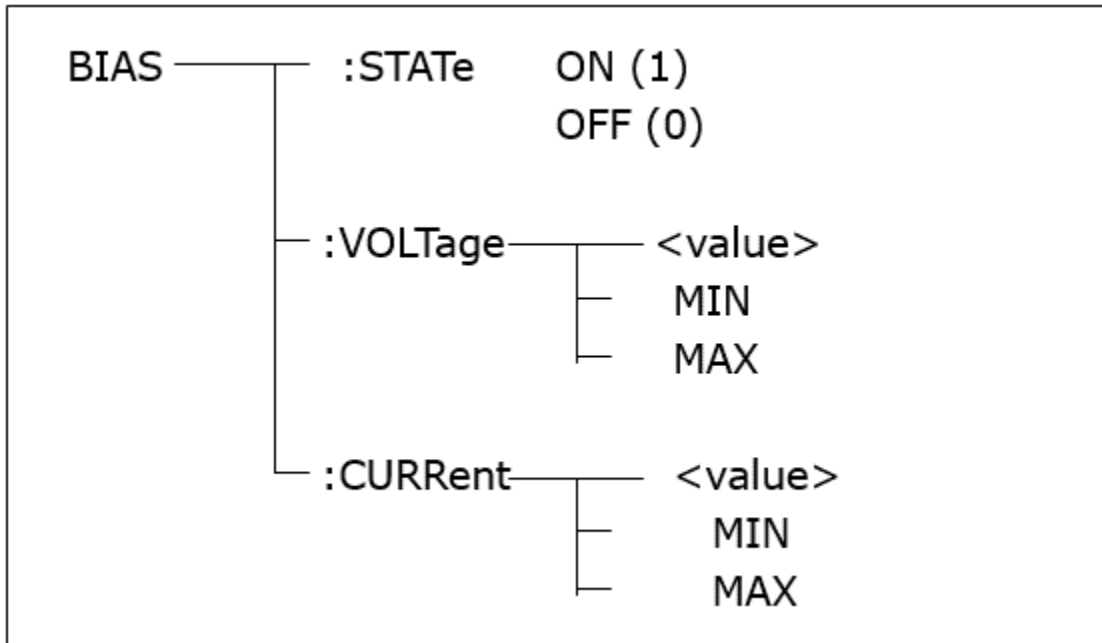

BIAS:STATe

This command is used to turn the DC BIAS Function on or off.

Command Syntax BIAS:STATe <state>
Query syntax Query syntax: BIAS:STATe?
Return format <NR1><NL^END>
Example 1 BIAS:STATe 0
 Turns the DC BIAS Function off.

Where <state> can be: 0 or OFF, or 1 or ON.

BIAS:VOLTAGE

This command is used to set the internal DC bias voltage.

Command Syntax BIAS:VOLTage <value>
Query syntax BIAS:VOLTage?
Return format <NR3><NL^END>
Example 1 BIAS:VOLT ON
 Turn the internal DC bias voltage on.

Where <value> can be: NR1, NR2 or NR3 data format followed by V.
 MIN= Set the measurement voltage as +/-5mV.

MAX= Set the measurement voltage as +/-2V.

BIAS:CURRent

Command Syntax BIAS:CURRent <value>

Query syntax BIAS:CURRent?

Return format <NR3><NL^END>

Example 1 BIAS:CURR 40MA

Where <value> can be: NR1, NR2 or NR3 data format followed by MA.

MIN= Set the measurement voltage as +/- 0 mA.

MAX= Set the measurement voltage as +/-50 mA.

2.10 FUNCTION subsystem commands

The FUNCTION subsystem commands are used to set measurement functions, range, current/voltage monitor ON/OFF, deviation display mode, and nominal setting.

Refer to the image in the next page for the command tree of the FUNCTION Subsystem.

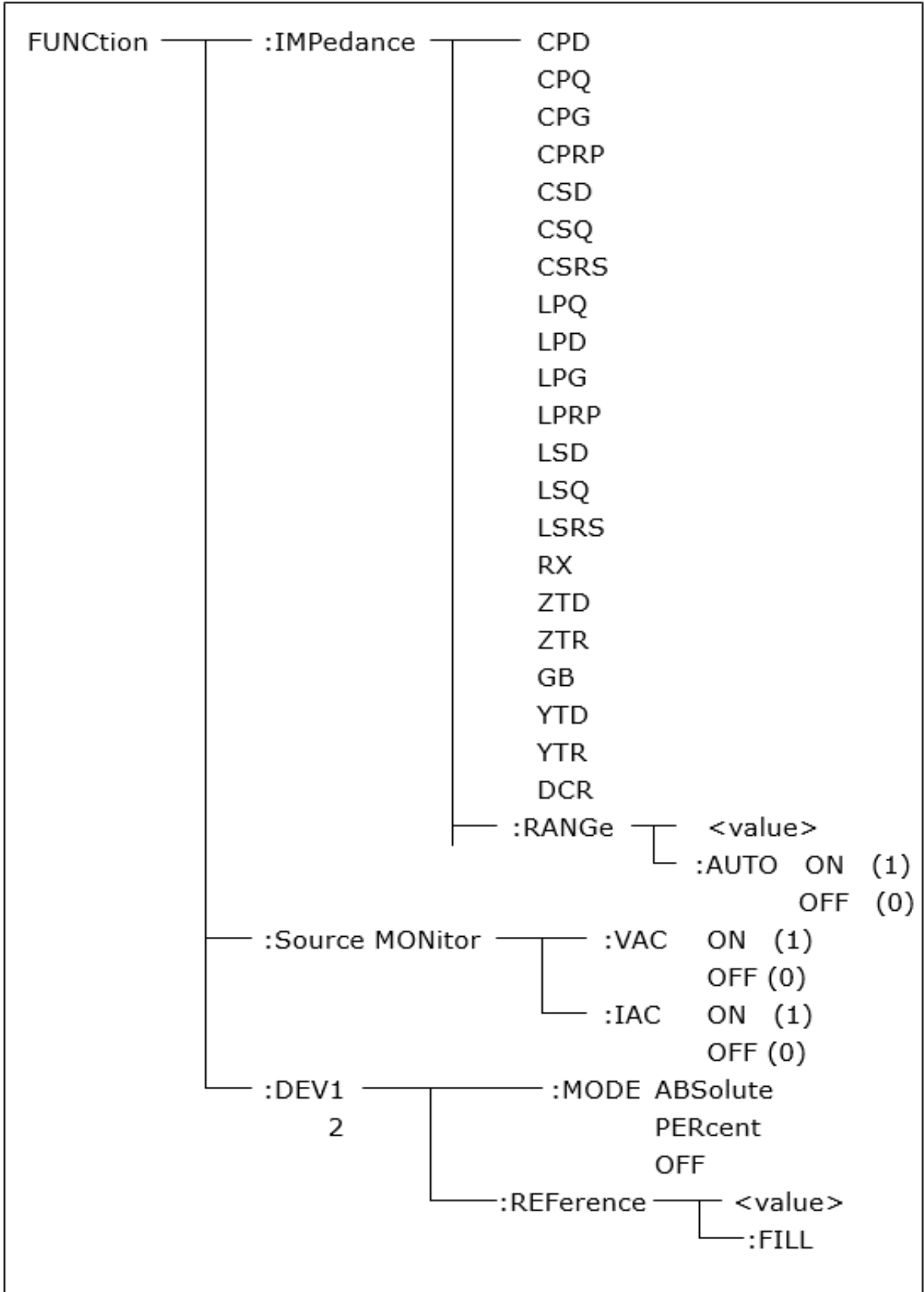

FUNCTION:IMPedance

The FUNCTION:IMPedance command is used to set and select the measurement function.

Command Syntax FUNCTION:IMPedance <function>
Query syntax FUNCTION:IMPedance?
Return format <function><NL^END>
Example 1 FUNC:IMP RX
Set the function as R-X.

Where <function> is one of the selections below:

Function	Mode	Function	Mode
CPD	Set the function as Cp-D	LPRP	Set the function as Lp-Rp
CPQ	Set the function as Cp-Q	LSD	Set the function as Ls-D
CPG	Set the function as Cp-G	LSQ	Set the function as Ls-Q
CPRP	Set the function as Cp-Rp	LSRS	Set the function as Ls-Rs
CSD	Set the function as Cs-D	RX	Set the function as R-X
CSQ	Set the function as Cs-Q	ZTD	Set the function as Z- θ°
CSRS	Set the function as Cs-Rs	ZTR	Set the function as Z- θ_r
LPQ	Set the function as Lp-Q	GB	Set the function as G-B
LPD	Set the function as Lp-D	YTD	Set the function as Y- θ°
LPG	Set the function as Lp-G	YTR	Set the function as Y- θ_r

FUNCTION:IMPedance:RANGe

Selects the impedance measurement range. This command turns the auto range function OFF when is used.

Command Syntax FUNCTION:IMPedance:RANGe <value>
Query syntax FUNCTION:IMPedance:RANGe?
Return format <value><NL^END>
Example 1 FUNC:IMP:RANG 1KOHM
Set the value of the range to 1kOHM

Where, <value> can be the impedance of the DUT or NR1, NR2 or NR3 data format followed by OHM or KOHM.

10	30	100
300	1000	3000
10000	30000	100000

FUNCTION:IMPedance:RANGe:AUTO

The FUNCTION:IMPedance:RANGe:AUTO command is used to set the automatic range selection status.

Command Syntax	FUNCTION:IMPedance:RANGe:AUTO <status>
Query syntax	FUNCTION:IMPedance:RANGe?
Return format	<NR1><NL^END>
Example 1	FUNC:IMP:RANG:AUTO ON Set the automatic range as ON.

Where <status> can be: 0 or OFF, or 1 or ON.

FUNCTION:Source MONitor:VAC

The FUNCTION:Source MONitor:VAC command is used to set the voltage monitor ON or OFF.

Command Syntax	FUNCTION:SMONitor:VAC <status>
Query syntax	FUNCTION:SMONitor:VAC?
Return format	<NR1><NL^END>
Example 1	FUNC:SMON:VAC ON Set the voltage monitor as ON.

Where <status> can be: 0 or OFF, or 1 or ON.

FUNCTION:SMONitor:IAC

The FUNCTION:SMONitor:IAC command enables the AC current-level monitor function.

Command Syntax	FUNC:SMONitor:IAC <status>
Query syntax	FUNCTION:SMONitor:IAC?
Return format	FUNCTION:SMONitor:IAC?
Example 1	<NR1><NL^END>

FUNCTION:DEV<n>:MODE

The FUNCtion:DEV<n>:MODE command is used to set and query the deviation measurement mode.

Command Syntax FUNCtion:DEV<n>:MODE<deviation>
Query syntax Query syntax: FUNCtion:DEV<n>:MODE?
Return format <deviation><NL^END>
Example 1 FUNC:DEV1:MODE ABS

Where <deviation> can be:

ABSolute	Absolute value deviation display
PERCent	Percent deviation display
OFF	Real value display

When n=1 the deviation mode is being set to the nominal value of primary parameter.
When n=2 the deviation mode is being set to the nominal value of the secondary parameter.

FUNCtion:DEV<n>:REFerence<value>

This command is used to set the nominal value of the deviation.

Command Syntax FUNCtion:DEV<n>:REFerence<value>
Query syntax FUNCtion:DEV<n>:REFerence?
Return format <NR3><NL^END>
Example 1 FUNC:DEV1:REF 10

Where, <value> can be 1 or 2.

When n=1, equal to the nominal value of primary parameter.

When n=2, is equal to the nominal value of the secondary parameter.

Where, <value> is NR1, NR2 or NR3 data format.

FUNCtion:DEV<n>:REFerence:FILL

This command is used to set the nominal value of the deviation. This command directs the instrument to make a test and then copies the results of the primary and the secondary parameters as the nominal values of the deviation.

Command Syntax FUNCtion:DEV<n>:REFerence:FILL
Query syntax N/A
Example 1 FUNC:DEV1:REF:FILL

Where, <value> can be 1 or 2.

When n=1, equal to the nominal value of primary parameter.

When n=2, is equal to the nominal value of the secondary parameter.

2.11 LIST subsystem commands

The LIST subsystem commands are mainly used to set the list sweep function, sweep points, sweep mode, sweep limits.

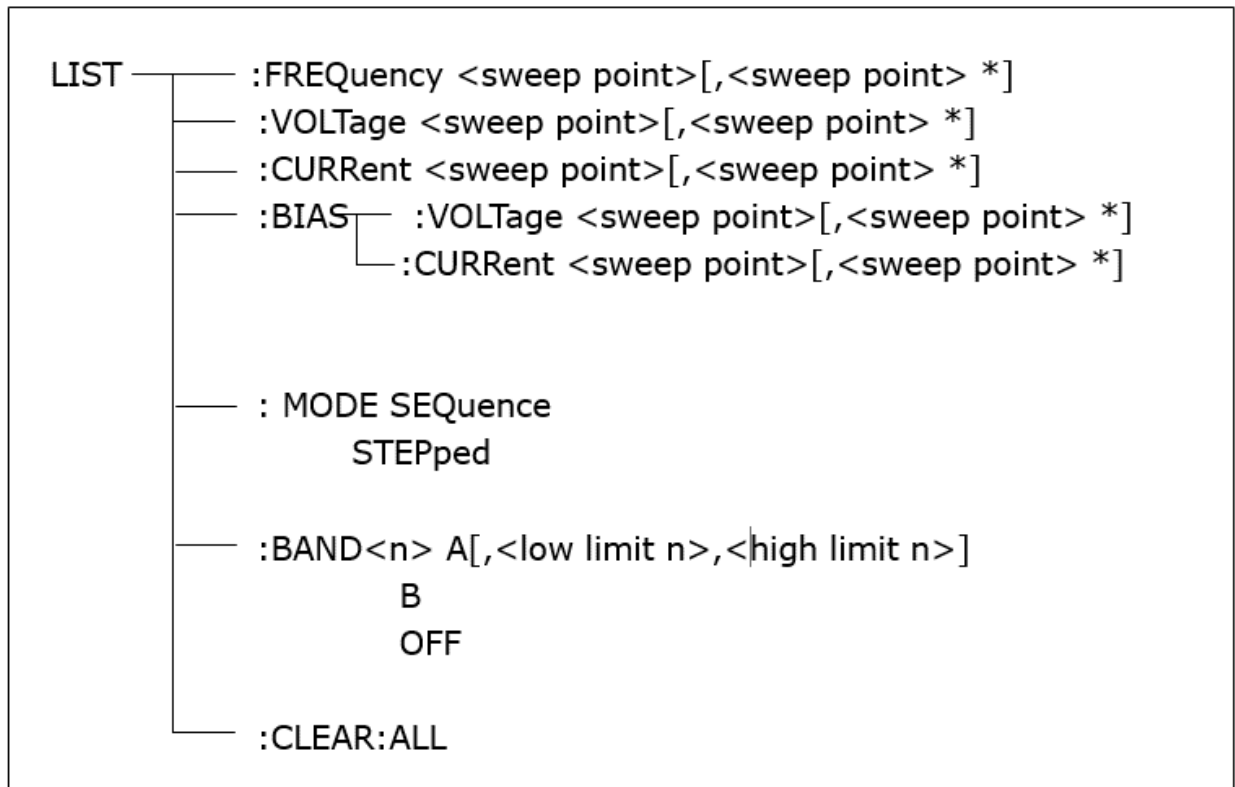

LIST:FREQuency

This command is used to clear the original sweep points and set the frequencies of a new list frequency sweep points.

Command Syntax LIST:FREQuency <value>[, <value>*]

Query syntax LIST:FREQuency?

Return format <NR3>, [,<NR3>*]<NL^END>

Example LIST:FREQ 133, 1KHZ, 1MHZ, 4E3

Set the frequency of the sweep point 1 as 133 Hz

Set the frequency of the sweep point 2 as 1KHZ

Set the frequency of the sweep point 3 as 1MHZ

Set the frequency of the sweep point 4 as 4KHZ.

* 201 sweep points, at most, can be set.

Where, <value> is NR1, NR2 or NR3 data format.

<value> is 20HZ to 500KHZ (894), 20HZ to 1MHZ (895), if a value outside this range is sent, that specific sweep point will be ignored and it will generate errors when querying this command.

The units of frequency, Hz, could be used after the frequency value, as shown in the example above. HZ (hertz) is the default unit.

LIST:VOLTage

This command is used to clear the voltage of each sweep point by overwriting the set values with the new values sent and clearing the points that are not set in the new list.

Command Syntax LIST:VOLTage <value>[, <value>*]

Query syntax LIST:VOLTage?

Return format <NR3>[, <NR3>*]<NL^END>

Example 1 LIST:VOLT\s5E-3,\s2E-2,\s0.035V,\s200MV\n
Set the voltage of the sweep point 1 as 5 mV
Set the voltage of the sweep point 2 as 20 mV
Set the voltage of the sweep point 3 as 35 mV
Set the voltage of the sweep point 4 as 200mV.

* 201 sweep points, at most, can be set.

Where, <value> is NR1, NR2 or NR3 data format.

<value> should be set from 5mV to 2V, if a value outside this range is sent, that specific sweep point will be ignored and it will generate errors when querying this command.

The unit of volts (V) or milli Volts (MV) could be used after the voltage value, as shown in the example above. Volts (V) is the default unit.

LIST:CURREnt

This command is used to clear the current of each sweep point by overwriting the set values with the new values sent and clearing the points that are not set in the new list.

Command Syntax LIST:CURREnt<value>[, <value>*]

Query syntax LIST:CURREnt?

Return format <NR3>[, <NR3>*]<NL^END>

Example 1 LIST:CURREnt 5E-3, 20, 0.015A, 10MA
Set the voltage of the sweep point 1 as 5 mA.
Set the voltage of the sweep point 2 as 20 mA.
Set the voltage of the sweep point 3 as 15 mA.
Set the voltage of the sweep point 4 as 10 mA.

* 201 sweep points, at most, can be set.

Where, <value> is NR1, NR2 or NR3 data format.

<value> should be set from 50µA to 20mA, if a value outside this range is sent, that specific sweep point will be ignored and it will generate errors when querying this command.

The unit of volts (A) or milli Amps (MAV) could be used after the current value, as shown in the example above. Volts (V) is the default unit.

LIST:BIAS:VOLTage

This command is used to clear the DC Bias Voltage of each sweep point by overwriting the set values with the new values sent and clearing the points that are not set in the new list.

Command Syntax LIST:BIAS:VOLTage<value>[, <value>*]

Query syntax LIST:BIAS:VOLTage?

Return format <NR3>[, <NR3>*]<NL^END>

Example 1 LIST:BIAS:VOLT 1E-4, 2E-2, 5, 4V

Set the voltage of the sweep point 1 as 0.1 mV.

Set the voltage of the sweep point 2 as 20 mV.

Set the voltage of the sweep point 3 as 5 V.

Set the voltage of the sweep point 4 as -4 V.

* 201 sweep points, at most, can be set.

Where, <value> is NR1, NR2 or NR3 data format.

<value> should be set from -5 V to 5 V, if a value outside this range is sent, that specific sweep point will be ignored and it will generate errors when querying this command.

The unit of volts (V) or milli Volts (MV) could be used after the voltage value, as shown in the example above. Volts (V) is the default unit.

LIST:BIAS:CURREnt

This command is used to clear the DC Bias Current of each sweep point by overwriting the set values with the new values sent and clearing the points that are not set in the new list.

Command Syntax LIST:BIAS:CURREnt<value>[, <value>*]

Query syntax LIST:BIAS:CURREnt?

Return format <NR3>[, <NR3>*]<NL^END>

Example 1 LIST:BIAS:CURREnt 1E-4, 2E-2, 5mA, -2mA.

Set the voltage of the sweep point 1 as 100 µA.

Set the voltage of the sweep point 2 as 20 mA.

Set the voltage of the sweep point 3 as 5 mA.

Set the voltage of the sweep point 4 as -2 mA.

* 201 sweep points, at most, can be set.

Where, <value> is NR1, NR2 or NR3 data format.

<value> should be set from -50 mA to +50 mA, if a value outside this range is sent, that specific sweep point will be ignored and it will generate errors when querying this command.

The unit of volts (A) or milli Amps (MAV could be used after the current value, as shown in the example above. Volts (V) is the default unit.

LIST:MODE

This command is used to set the list sweep mode.

Command Syntax LIST:MODE <mode>

Query syntax LIST:MODE?

Return format <mode><NL^END>

Example 1 LIST:MODE SEQ

Where, <mode> can be:

SEQuence: Sequential mode.

STEPped: Single step mode. One step per trigger signal.

LIST:BAND

This command is used to set the limits of list sweep table.

Command Syntax LIST:BAND<n><parameter>[,<low limit n>,<high limit n>]

Query syntax LIST:BAND<n>?

Return format <parameter>, <low limit n>, <high limit n>

Example 1 LIST:BAND3 OFF

Where:

<n> can be 1 to 201 (NR1 format): sweep points on the nth line

<parameter> can be A or B:

A= Compare the primary parameter of the test results with the high and the low limits.

B= Compare the secondary parameter of the test results with the high and the low limits.

OFF No comparison

<low limit n> NR1, NR2 or NR3 data format, low limit of the sweep point on the nth line.

<high limit n> NR1, NR2 or NR3 data format, high limit of the sweep point on the nth line.

LIST:CLEAr:ALL

This command is used to clear the setting data of all sweep points.

Command Syntax LIST:CLEAR:ALL

Query syntax N/A

Return format N/A

Example 1 LIST:CLEAR:ALL

2.12 APERture subsystem commands

The APERture subsystem commands are used to set the measurement speed, averaging times used in measurement.

APERture

This command is used to set the measurement speed and the averaging times used during measurements.

Command Syntax APERture <speed> [,<value>]

Query syntax APERture?

Return format <speed>, <NR1><NL^END>

Example 1 APER MED, 55

Sets the speed to MEDIUM, and averaging times to 55. This means that the meter will take 55 measurements at medium speed and present the average as the result.

2.13 TRIGger subsystem commands

The TRIGger subsystem commands are used to set the instrument trigger source, trigger delay and trigger measurement.

Command tree:

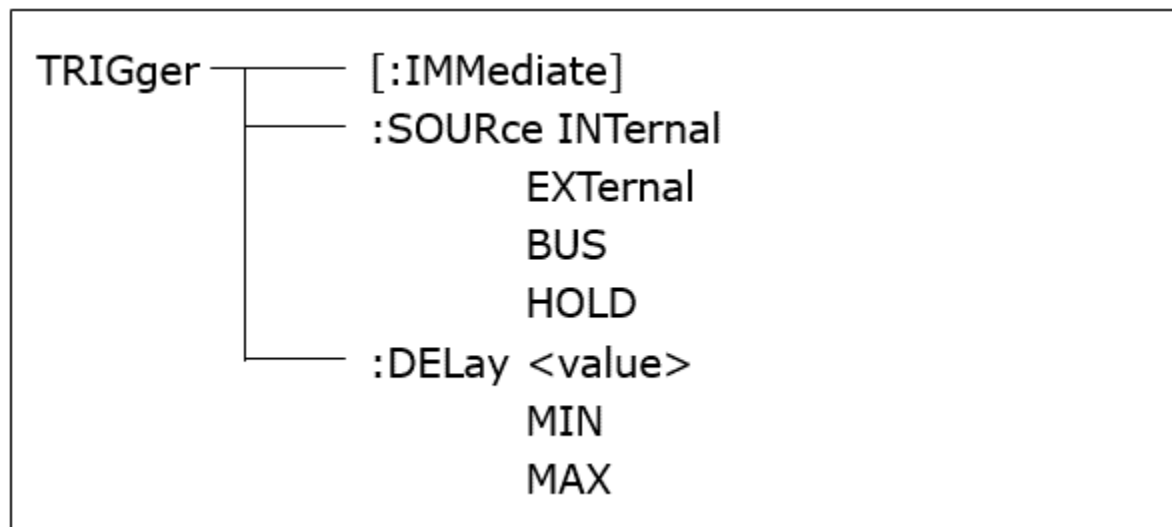

TRIGGER

This command is used to send a trigger signal to the LCR meter and start a test.

Command syntax: TRIGGER[:IMMEDIATE]

For example:

Command Syntax TRIGGER[:IMMEDIATE]

Query syntax N/A

Return format N/A

Example 1 WrtCmd("TRIG")

TRIGGER:SOURCE

This command is used to set the trigger source mode.

Command Syntax TRIGGER:SOURCE <source>

Query syntax TRIGGER:SOURCE?

Return format <source><NL^END>

Example 1 TRIG:SOUR BUS

Where:

INTERNAL The default trigger mode.

EXTERNAL Triggered by HANDLER interface.

BUS Triggered by RS232C interface or GPIB interface

HOLD Triggered by pressing TRIGGER.

TRIGGER:DELAY

This command is used to set the delay time after triggering.

Command Syntax TRIGger:DELay <value>
Query syntax TRIGger:DELay?
Return format <NR3><NL^END>
Example 1 TRIG:DEL 5s
Set the trigger delay to 5 seconds

Where <value> is in the NR1, NR2 or NR3 data format and a valid range from 0 to 60s with 1ms as the resolution.

MIN Set the delay time as 0s.

MAX Set the delay time as 60s.

2.14 FETCh? Subsystem Commands

The FETCh? subsystem commands are used to direct the 894/895 to fetch the last to input a measurement result.

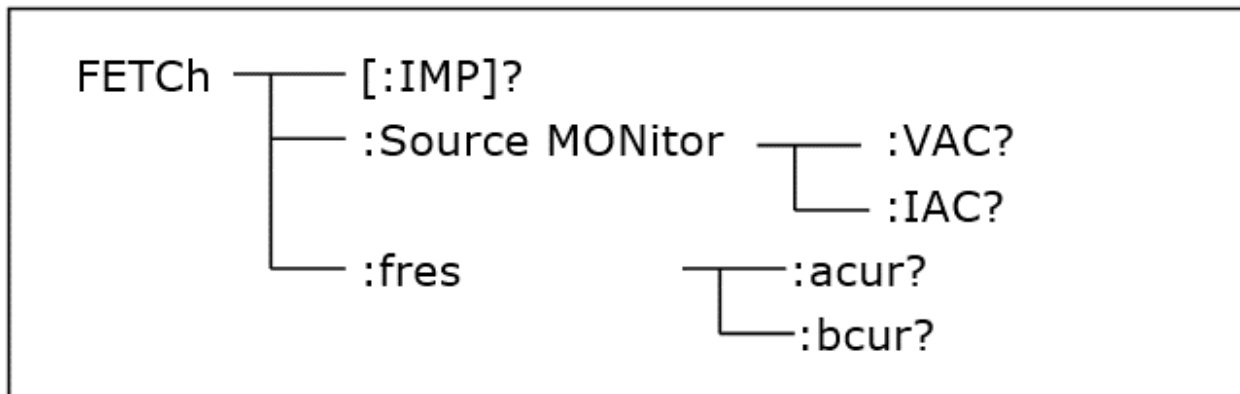

FETCh

This command queries the last measurement of the from the output buffer.

Command Syntax N/A
Query syntax FETCh[:IMP]?
Return format <DATA A>,<DATA B>,<Status>,<BIN number><NL^END>
Example 1 FETC?
Queries the last measurement on the output buffer.

Where:

<DATA A> = primary measurement data.

<DATA B> = secondary measurement data.

The return format will be displayed as follows:

SN.NNNNNeSNN	,	SN.NNNNNeSNN	,	SN	NL^END
<DATA A>		<DATA B>		<Status>	New line

Where:

S = +/-

N= 0 to 9

e = Exponent (1.03e-3 = 0.00103)

<status> return format uses 2 ASCII characters, plus or minus and the value which as the following table details can be a value between -1 and +4.

<status> will display the measurement status with the following values:

<status> format is SP, where "S" is as described above and "P" valid values are from 0 to 4.

Status		Description
S	N	
-	1	No data in buffer memory
0	0	Normal measurement data
+	1	Analog LCR unbalance
+	2	A/D converter is not working.
+	3	Signal source is over loading.
+	4	Constant voltage cannot be adjusted.

When the COMPARE function is enabled:

The LCR will not return the following string:

SN.NNNNNeSNN	,	SN.NNNNNeSNN	,	SN	,	SN	NL^END
<DATA A>		<DATA B>		<Status>		<result>	New line

- **<Bin number>**

Bin data is only available and displayed only when compare function is set as ON.

The data displays the sorting results of the displayed bin, shown below.

Data	Sort result
0	Out of tolerance
+1	Bin 1
+2	Bin 2
+3	Bin 3
+4	Bin 4

+5	Bin 5
+6	Bin 6
+7	Bin 7
+8	Bin 8
+9	Bin 9
+10	Auxiliary bin

2.15 CORRection subsystem commands

The CORRection subsystem commands are used to set and select the correction function: OPEN, SHORT, LOAD.

Command tree:

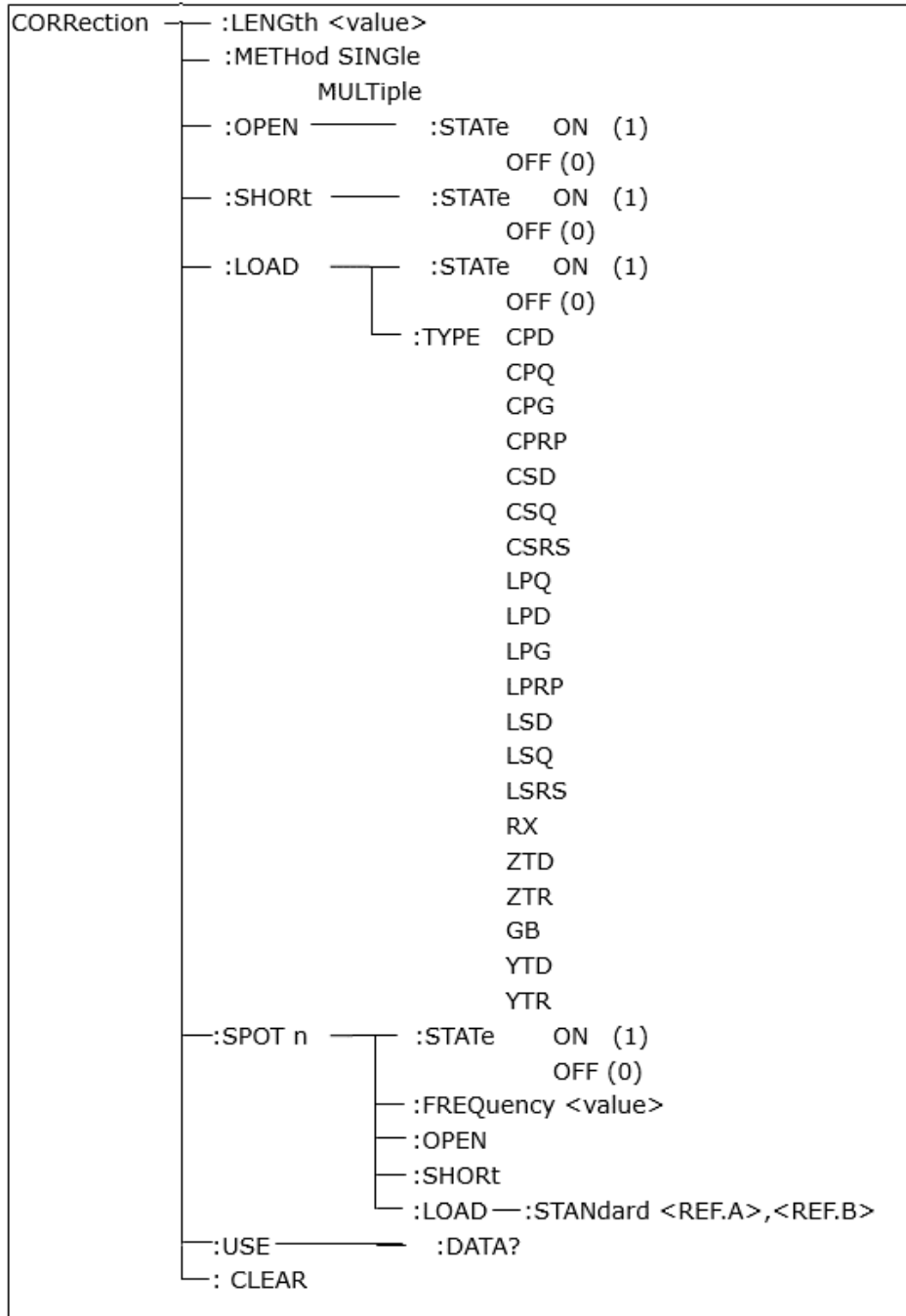

CORRection:LENGTh

This command is used to the correction factor for the cable length.

Command Syntax CORRection:LENGTh<value>

Query syntax CORRection:LENGTh?

Return format <NR1><NL^END>

Example 1 CORR:LENG 1M

Set the correction factor for a cable of 1 meter.

Where <value> is 0, 1, 2 or 4 followed by M.

CORRection:MEtHod

This command is used to set the correction mode to single or multi-channel.

Command Syntax CORRection:MEtHod <method>

Query syntax CORRection:MEtHod?

Return format <method><NL^END>

Example 1 CORR:MEtH SING

Where <method> can be:

SINGle Set or return single channel mode.

MULTi Set or return multi-channel mode.

CORRection:OPEN

This command is used to execute an open correction for the following preset test points.

Command Syntax CORRection:OPEN

Query syntax N/A

Return format N/A

Example 1 CORR:OPEN

Hz	Hz	kHz	kHz	kHz	MHz
20	100	1.0	10	100	1*
25	120	1.2	12	120	*895 only
30	150	1.5	15	150	
40	200	2.0	20	200	
50	250	2.5	25	250	
60	300	3.0	30	300	
80	400	4.0	40	400	
	500	5.0	50	500	
	600	6.0	60	600*	
	800	8.0	80	800*	

CORRection:OPEN:STATe

This command is used to set the open correction ON or OFF.

Command Syntax CORRection:OPEN:STATe <state>

Query syntax CORRection:OPEN:STATe?

Return format <NR1><NL^END>

Example 1 CORR:OPEN:STAT ON
Turns the Open Correction function ON.

Where, <state> can be:

ON = 1

OFF = 0

CORRection:SHORT:STATe

This command is used to set the Short Correction ON or OFF.

Command Syntax CORRection:SHORT:STATe <state>

Query syntax CORRection:SHORT:STATe?

Return format <NR1><NL^END>

Example 1 CORR:SHORT:STAT OFF
Turns the Short Correction function OFF.

Where, <state> can be:

ON = 1

OFF = 0

CORRection:LOAD:STATe

This command is used to set the Load Correction ON or OFF.

Command Syntax CORRection:LOAD:STATe <state>

Query syntax CORRection:LOAD:STATe?

Return format <NR1><NL^END>

Example 1 CORR:LOADt:STAT OFF
Turns the Load Correction function OFF.

Where, <state> can be:

ON = 1

OFF = 0

The CORRection:LOAD:TYPE

This command is used to set the test parameter type.

Command Syntax CORRection:LOAD:TYPE <type>

Query syntax CORRection:LOAD:TYPE?

Return format <function><NL^END>

Example 1 CORR:LOAD:TYPE CPD

Sets the Correction Load Type to use the capacitance in parallel mode, and dissipation factor to be used during the correction.

Where, <type> can be:

TYPE	FUNCTION	TYPE	Function
CPD	Set the function as Cp-D	LPRP	Set the function as Lp-Rp
CPQ	Set the function as Cp-Q	LSD	Set the function as Ls-D
CPG	Set the function as Cp-G	LSQ	Set the function as Ls-Q
CPRP	Set the function as Cp-Rp	LSRS	Set the function as Ls-Rs
CSD	Set the function as Cs-D	RX	Set the function as R-X
CSQ	Set the function as Cs-Q	ZTD	Set the function as Z- θ°
CSRS	Set the function as Cs-Rs	ZTR	Set the function as Z- θ_r
LPQ	Set the function as Lp-Q	GB	Set the function as G-B
LPD	Set the function as Lp-D	YTD	Set the function as Y- θ°
LPG	Set the function as Lp-G	YTR	Set the function as Y- θ_r

CORRection:SPOT<n>:STATe

This command is used to set and query the state of the correction spot. It lets the user turn on or off specific points during the spot correction.

Command Syntax CORRection:SPOT <n>:STATe <state>

Query syntax CORRection:SPOT <n>:STATe?

Return format <NR1><NL^END>

Example 1 CORR:SPOT 11:STAT ON

Turn the Spot Correction of spot #11 on.

Where,

<state>: 0 or OFF, or 1 or ON

<n>: 0 or OFF, or 1 or ON.

CORRection:SPOT<n>:FREQUency

This command is used to set the frequency of the correction spots.

Command Syntax CORRection:SPOT<n>:FREQUency<value>

Query syntax CORRection:SPOT<n>:FREQUency?

Return format <NR3><NL^END>

Example 1 CORR:SPOT 15:FREQ 2KHZ
Set the Spot Correction in spot 15 to 2 KHz.

Where,

<value>: NR1, NR2 or NR3 data format followed by HZ, KHZ and MHZ. Range is 20 Hz to 500 kHz (894) 20 Hz to 1 MHz (895).

<n>: One of the 201 correction spots.

CORRection:SPOT<n>:OPEN

This command is used to execute open correction for the current correction spot.

Command Syntax CORRection:SPOT <n>:OPEN

Query syntax N/A

Return format N/A

Example 1 CORR:SPOT 1:OPEN
Executes an open correction in spot #1.

Where,

<n>: One of the 201 correction spots.

CORRection:SPOT<n>:SHORT

This command is used to execute short correction for the current correction spot.

Command Syntax CORRection:SPOT <n>:SHORT

Query syntax N/A

Return format N/A

Example 1 CORR:SPOT 10:SHORT
Executes a short correction in spot #10.

Where,

<n>: One of the 201 correction spots.

CORRection:SPOT<n>:LOAD:STANdard

This command is used to set the standard reference of the current correction spot.

Command Syntax CORRection:SPOT <n>:LOAD:STANdard <REF. A>
<REF. B>

Query syntax CORRection:SPOT <n>:LOAD:STANdard?

Return format <NR3><NL^END>

Example 1 CORR:SPOT1:LOAD:STAN 100.7, 0.0002
Set the standard reference value for spot #1, to 100.7 for the primary , and 0.0002 for the secondary parameter.

Where,

<n>: One of the 201 correction spots.

<REF. A> can be NR1, NR2 or NR3 data format and taken as the standard reference of the primary parameter.

<REF. B> can be NR1, NR2 or NR3 data format and taken as the standard reference of the secondary parameter.

CORRection:USE:DATA?

This query returns the OPEN/SHORT/LOAD correction measurement data of 201 correction spots.

Command Syntax N/A

Query syntax CORRection:USE:DATA? <channel number>

Return format See below.

Example 1 CORRection:USE:DATA?

<open1 A>,<open1 B>,<short1 A>,<short1 B>,<load1 A>,<load1 B>,
<open2 A>,<open2 B>,<short2 A>,<short2 B>,<load2 A>,<load2 B>,
<open3 A>,<open3 B>,<short3 A>,<short3 B>,<load3 A>,<load3 B>,
...

Where,

<open n A> is NR3 data format and the primary open correction data at the correction spot n.

<open n B> is NR3 data format and the secondary open correction data at correction spot n.

<short n A> is NR3 data format and the primary short correction data at correction spot n.

<short n B> is NR3 data format and the secondary short correction data at correction spot n.

<load n A> is NR3 data format and the primary load correction data at correction spot n.

<load n B> is NR3 data format and the secondary load correction data at correction spot n.

CORRection:CLEAr

This command is used to clear the correction data of all the correction spots.

Command Syntax CORRection:CLEAr

Query syntax N/A

Return format N/A

Example 1 CORRection:CLEAr
Clears the correction data.

2.16 COMParator subsystem commands

The COMParator subsystem commands are used to set the bin comparator function including ON/OFF setting, and Limit table setting.

Command tree:

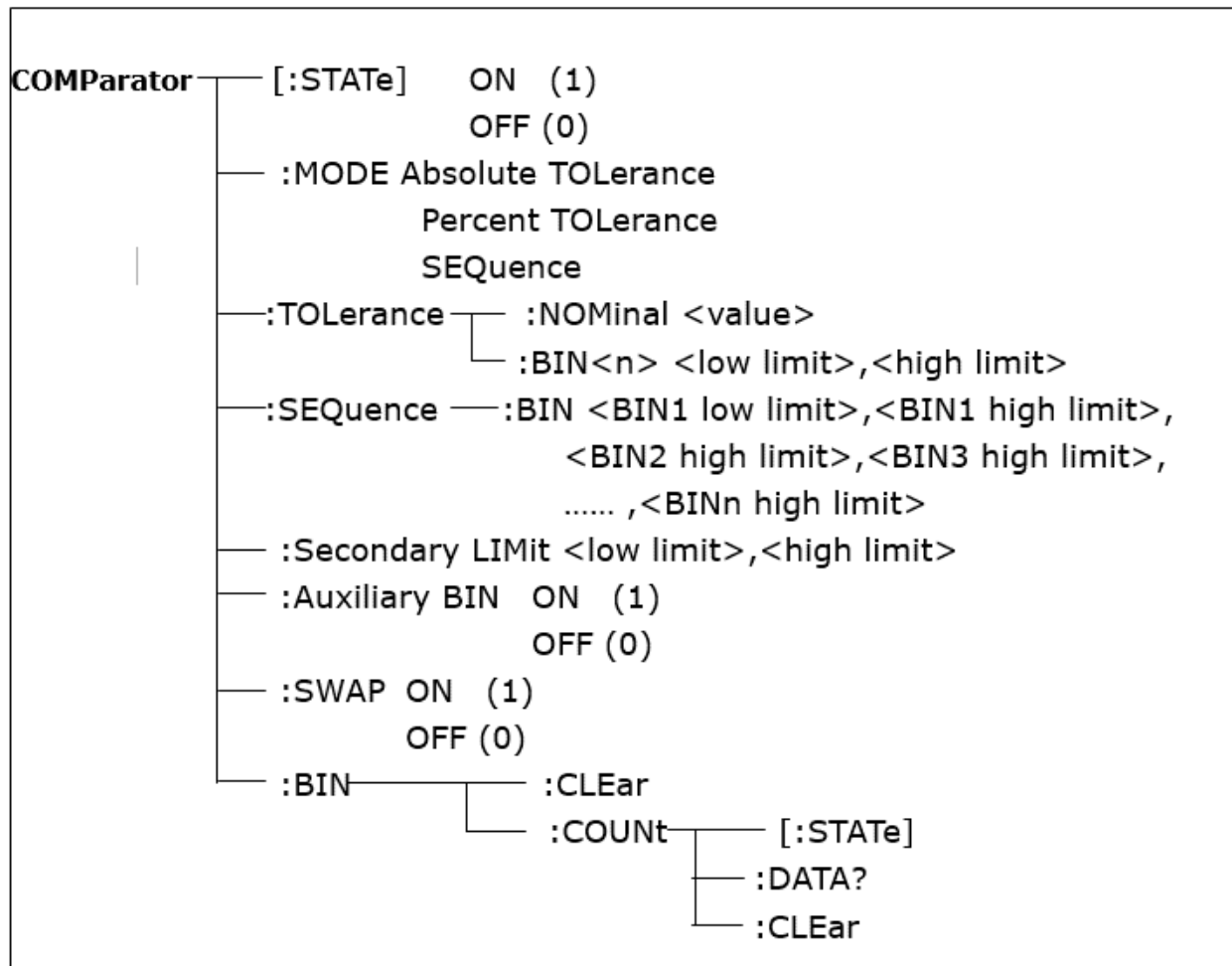

COMParator[STATe]

This command is used to set the comparator function ON or OFF.

Command Syntax COMParator <state>

Query syntax COMParator <state>?

Return format <NR1><NL^END>.

Example 1 COMP ON
Turns the comparator ON.

Where,

<state>: 0 or OFF, or 1 or ON

COMParator:MODE

This command is used to set the comparator mode.

Command Syntax COMParator:MODE <mode>

Query syntax COMParator:MODE?

Return format <mode><<NL^END>

Example 1 COM:MODE ATOL
Set the comparator mode to absolute tolerance mode.

Where,

ATOLerance means absolute tolerance mode.

PTOLerance means proportional tolerance mode.

SEQUence means sequential tolerance mode.

COMParator:TOLerance:NOMinal

This command is used to set the nominal value (this function is valid only when the limit mode is set as deviation mode).

Command Syntax COMParator:TOLerance:NOMinal<value>

Query syntax COMParator:TOLerance:NOMinal?

Return format <NR3><NL^END>

Example 1 COMP:TOL:NOM 100E-12
Sets the tolerance nominal value, when the limit mode is set as deviation mode, to 100E-12.

<value> is a nominal value in NR1, NR2 or NR3 data format.

COMParator:TOLerance:BIN<n>

This command is used to set the high and the low limits of each bin (this function is valid only when the limit mode is set as deviation mode).

The COMParator:TOLerance:BIN<n>?

Command Syntax COMParator:TOLerance:BIN<n><low limit><high limit>

Query syntax COMParator:TOLerance:BIN<n>?

Return format <low limit><high limit><NL^END>

Example 1 COMP:TOL:BIN2 -10,10
Set the high value of bin 2 to 10.
Set the low value of bin 2 to -10

Where,

<n> is the bin number from 1 to 9.

<low limit> is the low limit in NR1, NR2 or NR3 data format.

<high limit> is the high limit in NR1, NR2 or NR3 data format.

The low limit should be smaller than the high limit or an error will be issued.

COMParator:SEQuence:BIN

This command is used to set the high and the low limits of sequential mode (this function is valid only when the limit mode is set as the sequential mode).

Command Syntax COMParator:SEQuence:BIN <BIN1 low limit>, <BIN 1 high limit>, <BIN2 high limit>, ..., <BINn high limit>

Query syntax COMParator:SEQuence:BIN?

Return format <BIN1 low limit>, <BIN1 high limit>, <BIN2 high limit>, ..., <BINn high limit><NL^END>

Example 1 COMP:SEQ:BIN 10, 20, 30, 40, 50

Where,

<BIN1 low limit> is the low limit of BIN 1 in NR1, NR2 or NR3 data format.

<BIN1 high limit> is the high limit of BIN1 in NR1, NR2 or NR3 data format.

<BINn high limit> is the high limit of BINn (the maximum of n is 9) in NR1, NR2 or NR3 data format.

The low limit should be smaller than the high limit or an error will be issued.

COMParator:SecondaryLIMit

This command is used to set the high and the low limits of the secondary parameter.

Command Syntax COMParator:SLIMit <low limit>,<high limit>

Query syntax COMParator:SLIMit?

Return format <NR3><NL^END

Example 1 COMP:SLIM 0.001, 0.002

Sets the low limit of the secondary parameter in the comparator to 0.001 and the high limit to 0.002.

Where,

<low limit> is the low limit in NR1, NR2 or NR3 data format.

<high limit> is the high limit in NR1, NR2 or NR3 data format.

The low limit should be smaller than the high limit or an error will be issued.

COMParator:Auxiliary BIN

This command is used to set the auxiliary bin as ON or OFF.

Command Syntax COMParator:AuxiliaryBIN <state>

Query syntax COMParator:Auxiliary BIN?

Return format <state><NL^END>

Example 1 COMP:ABIN ON

Turns the Auxiliary bin on.

Where,

<state>: 0 or OFF, or 1 or ON.

COMParator:SWAP

This command is used to set the swap mode ON or OFF. For example: the original function parameter is Cp-D, after the SWAP mode is set as ON, the function parameter will be changed as D-Cp. In this case, the limits from BIN1 to BIN9 become the high and the low limits of D, the original secondary limits become that of Cp. If this function is off, it will not affect the original measurements.

Command Syntax COMParator:SWAP <state>

Query syntax COMParator:SWAP?

Return format <state><NL^END>

Example 1 COMP:SWAP ON"

Turn the Swap function on.

COMParator:BIN:CLEar

This command is used to clear all limits on Limit Table setup page.

Command Syntax COMParator:BIN:CLEar

Query syntax N/A

Return format N/A

Example 1 COMP:BIN:CLE
Clear the limits on the Limit Table.

COMParator:BIN:COUNT

This command is used to set the bin count function as ON or OFF.

Command Syntax COMParator:BIN:COUNT <state>

Query syntax COMParator:BIN:COUNT?

Return format <NR1><NL^END>

Example 1 COMP:BIN:COUN ON
Sets the count of the bins on.

Where,
<state>: 0 or OFF, or 1 or ON.

COMParator:BIN:COUNT:DATA?

Command Syntax N/A

Query syntax COMParator:BIN:COUNT:DATA?

Return format <BIN1 count>, <BIN2 count>, ..., <BIN9 count>,
<OUT OF BIN count>, <AUX BIN count>
<NL^END>

Where,
<BIN1-9 count> is the count result of BIN1-9, in NR1 data format.
<OUT OF BIN count> is the count result of the OUT OF BIN, in NR1 data format.
<AUX BIN count> is the count result of the auxiliary bin, in NR1 data format.

COMParator:BIN:COUNT:CLEAr

This command is used to clear all bin count results.

Command Syntax COMParator:BIN:COUNT:CLEAr

Query syntax N/A

Return format N/A

Example 1 COMP:BIN:COUN:CLE
Clears all the bin count results.

2.17 Mass MEMory subsystem commands

The Mass MEMory subsystem commands are used for storing and loading files saved in the LCR meter.

Command tree:

Mass MEMory	:LOAD	:STATe	<record number>
	:STORe	:STATe	<record number>, “<string>”

MMEMory:LOAD:STATe

This command is used to load an existing file.

Command Syntax MMEMory:LOAD:STATe<value>

Query syntax N/A

Return format N/A

Example 1 MMEM:LOAD:STAT 1

Where,

<value> is the file number ranging from 0 to 39 (NR1).

MMEMory:STORe:STATe

This command is used to store the current settings of the LCR meter to an internal file.

Command Syntax MMEMory:STOR:STATe<value>, “<string>”

Query syntax N/A

Return format N/A

Example 1 MMEM:STOR:STAT 1, “Resistor meas”
Saves current settings to memory 1, with the name “Resistor meas”. If there is no

Where,

<value> is the file number ranging from 0 to 39 (NR1).

<string> can be ASCII character string (maximum length is 16). If <string> is no assigned a name, the default file name will be given to the settings file.

BK PRECISION[®]

22820 Savi Ranch Parkway
Yorba Linda, CA92887
www.bkprecision.com

© 2017 B&K Precision Corp.

v022117