

Blackboard

transaction *System*

MF4100

Installation Guide



Commerce Suite 



Blackboard

This Class B digital apparatus complies with
Canadian ICES-003

Cet appareil numérique de la classes B est conform
à la norme NMB-003 du Canada

This device complies with Part 15 of the FCC Rules. Operation is subject to the following two conditions: (1) This device may not cause harmful interference, and (2) this device must accept any interference received, including interference that may cause undesired operation.

Part 15.21: Changes or modifications not expressly approved by the party responsible for compliance could void the user's authority to operate the equipment.

NOTE: The manufacturer is not responsible for any radio or TV interference caused by unauthorized modifications to this equipment. Such modifications could void the user's authority to operate the equipment.

This equipment complies with the FCC radiation exposure limits set forth for an uncontrolled environment. End users must follow the specific operating instructions for satisfying RF exposure compliance. The antenna(s) used for this transmitter must be installed to provide a separation distance of at least 20 cm from all persons and must not be co-located or operating in conjunction with any other antenna or transmitter.

Contents

1 MF4100 INSTALLATION GUIDE

1 Overview

3 VESA Mounting Bracket Overview

3 Mounting Options

3 Screw Positions

4 Assembly Details

5 Mount the MF4100

6 Wall Mount Installation

6 Attended Wall Mount Installation

8 Unattended Wall Mount Installation

10 Table Top Mount Installation

10 Table Top Mount With The VESA Mounting Bracket

12 Table Top Mount Without The VESA Mounting Bracket

13 MF4100 Features and Specifications

DRAFT

FIGURES

Figure 1-1	Multi-Function Reader MF4100	1
Figure 1-2	Cat-5 Cable and Power Supply	2
Figure 1-3	MF4100 Hardware Kit	2
Figure 1-4	VESA Bracket.....	2
Figure 1-5	VESA Bracket Screw Position - Attended	3
Figure 1-6	VESA Bracket Screw Position - Unattended	4
Figure 1-7	VESA Bracket Assembly Details	4
Figure 1-8	Wall Mount Options	5
Figure 1-9	Table Top Mount Options.....	5
Figure 1-10	VESA Bracket - Attended Wall Mount	6
Figure 1-11	MF4100 Cable Ports	7
Figure 1-12	Attended Wall Mount VESA Bracket Orientation.....	7
Figure 1-13	Reader Secured to Pivot Plate - Attended Wall Mount.....	8
Figure 1-14	VESA Bracket - Unattended Wall Mount.....	8
Figure 1-15	Unattended Wall Mount VESA Bracket Orientation.....	9
Figure 1-16	VESA Bracket Rubber Feet.....	10
Figure 1-17	Table Top Mount - With VESA Bracket Cable Route.....	11
Figure 1-18	Reader Rubber Feet Installation Locations	12
Figure 1-19	Table Top Mount - No VESA Bracket Cable Route	12

DRAFT

MF4100 INSTALLATION GUIDE

OVERVIEW

The Blackboard MF4100 Multi-function reader incorporates both contactless and magnetic stripe reader capabilities, and can function as a:

- Copy Reader
- Laundry Reader
- POS Terminal

The MF4100 supports full video and audio playback allowing for a rich video experience for:

- Advertising
- Alerts and notifications
- Other special messages via a full color touch screen

For MF4100 features, see: [MF4100 Features and Specifications](#) (Page: 13).



Figure 1-1 Multi-Function Reader MF4100

OBJECTIVES

After reading this guide you can:

- Wall mount the MF4100
- Table top mount the MF4100

WHAT'S INCLUDED

A hardware kit is provided with a security plate, rubber feet, and screws to aid in mounting the unit.



Cat-5 Cable



Wall Mount Power Supply

Figure 1-2 Cat-5 Cable and Power Supply

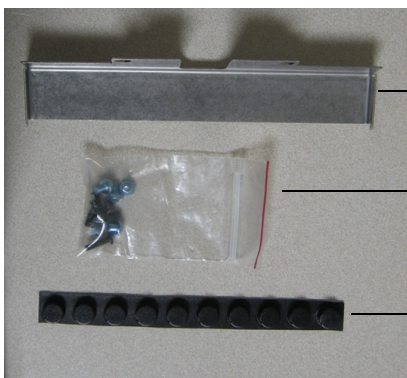

Security Plate

Screw kit

Rubber Feet

Figure 1-3 MF4100 Hardware Kit

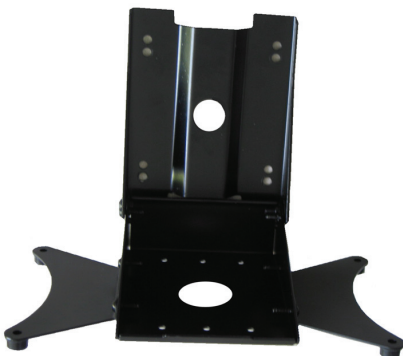

Figure 1-4 VESA Bracket

VESA MOUNTING BRACKET OVERVIEW

The MF4100 Multi-Function Reader ships with a VESA style mounting bracket. The mounting bracket is optional, but simplifies installation on vertical and horizontal surfaces. The VESA mounting bracket is adjustable to allow the MF4100 to be positioned at different angles.

Mounting Options

The VESA Mounting Bracket can be mounted in the following ways:

- Wall mount
 - Onto an electrical gang box (attended or unattended)
 - Directly to a wall (use suitable anchors)
- Table top mount
 - With VESA bracket (fixed 15 degree or adjustable angle)
 - Without VESA bracket

The holes in the center of the base and pivot plate allow cables to be routed out of the assembly.

Screw Positions

The VESA bracket has provisions for Attended or Unattended mounting positions. To use in attended locations, the top pivot plate can be used in any position by placing the lock screws in the position shown below.

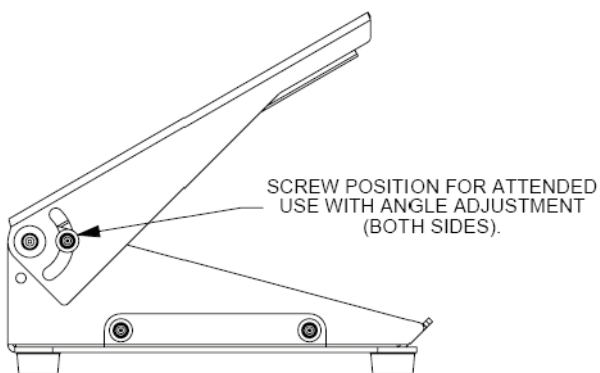

Figure 1-5 VESA Bracket Screw Position - Attended

For Unattended use, the mounting position can be fixed by placing the lock screws in the position shown below. This locked position conceals the cables from sight, and secures them from being tampered with.

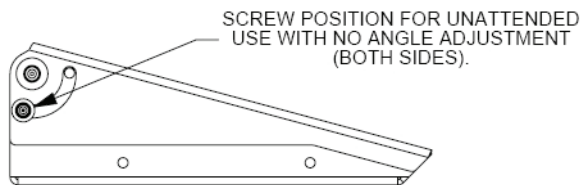

Figure 1-6 VESA Bracket Screw Position - Unattended

Assembly Details

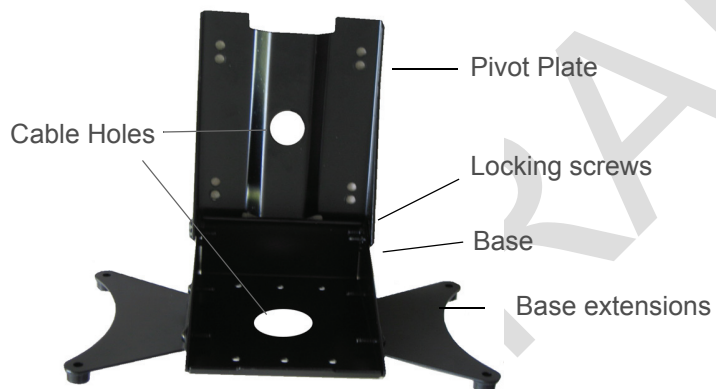

Figure 1-7 VESA Bracket Assembly Details

MOUNT THE MF4100

MF4100 MOUNTING OPTIONS:

- [Wall Mount Installation](#) (Page: 6)
- [Table Top Mount Installation](#) (Page: 10)



Attended wall mount



Unattended wall mount

Figure 1-8 Wall Mount Options



Fixed 15 degree angle



Adjustable angle



No VESA bracket

Figure 1-9 Table Top Mount Options

WALL MOUNT INSTALLATION

The VESA mounting bracket allows for two wall mount installation options:

- [Attended Wall Mount Installation](#) (Page: 6)
- [Unattended Wall Mount Installation](#) (Page: 8)

Attended Wall Mount Installation

- 1 Find a location on a single gang box to mount the MF4100.
Ensure there is enough clearance for the operator to access the touchscreen and swipe cards.
- 2 Remove the two base extensions by removing the 4 screws (1/8" Pin hex driver).
See: [VESA Bracket Assembly Details](#) (Page: 4).
- 3 Place the two locking screws in the position that allows the tilt plate to pivot (1/8" Pin hex driver).
See: [VESA Bracket Screw Position - Attended](#) (Page: 3).
- 4 Route the required cables through the VESA bracket cable hole, and then the pivot bracket hole.

Note the orientation of the VESA bracket to the wall.

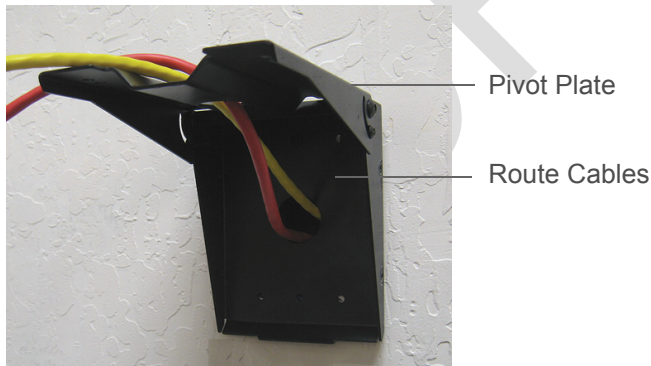

Figure 1-10 VESA Bracket - Attended Wall Mount

Note: The pivot plate attaches to the bottom of the MF4100 reader.

- 5 Attach the mounting base to the gang box using the two #6-32 pin hex screws provided in the hardware kit.
- 6 Install cables to the connectors of the MF4100.

The MF4100 can be powered using the +12 Volt wall mount power supply (included), or Power Over Ethernet (POE) switch. The power supply requires a dedicated 110 VAC outlet. POE provides power through the network cable, and reduces cable clutter. A CAT-5 cable must be connected between the POE switch to the RJ-45 connector on the MF4100 labeled Network, see the diagram below. When providing power with POE, the maximum LAN cable length must not exceed 100 meters.

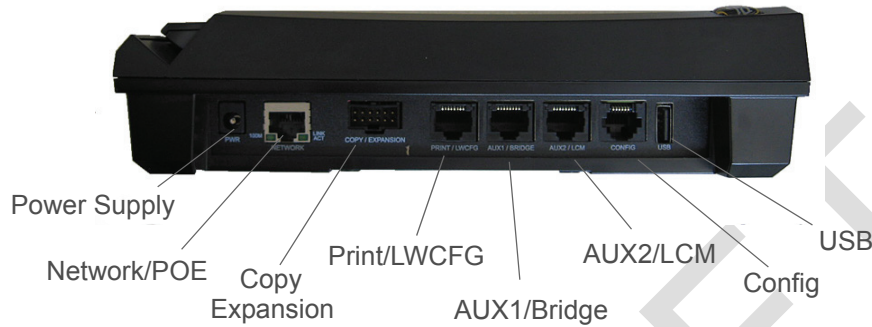

Figure 1-11 MF4100 Cable Ports

- 7 Place the security plate onto the MF4100, and then route the cables through the plate opening.

Note the orientation of the VESA bracket to the security plate.

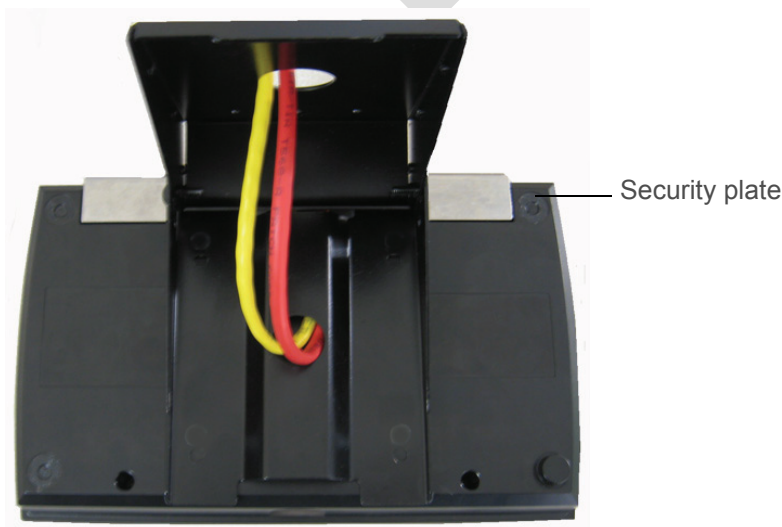

Figure 1-12 Attended Wall Mount VESA Bracket Orientation

- 8 Place the MF4100 assembly on the pivot plate, and then secure using four M4 x 6mm machine screws provided in the hardware kit.



Figure 1-13 Reader Secured to Pivot Plate - Attended Wall Mount

- 9 Position the pivot plate to the desired angle, and then tighten the 2 locking screws (1/8" pin hex driver).

Unattended Wall Mount Installation

- 1 Find a location on a single gang box to mount the MF4100.
Ensure there is enough clearance for the operator to access the touchscreen and swipe cards.
- 2 Remove the two base extensions by removing the 4 screws (1/8" pin hex driver).
See: [VESA Bracket Assembly Details](#) (Page: 4).
- 3 Route the required cables through the VESA bracket cable hole, and then the pivot bracket hole.

Note the orientation of the VESA bracket to the wall.

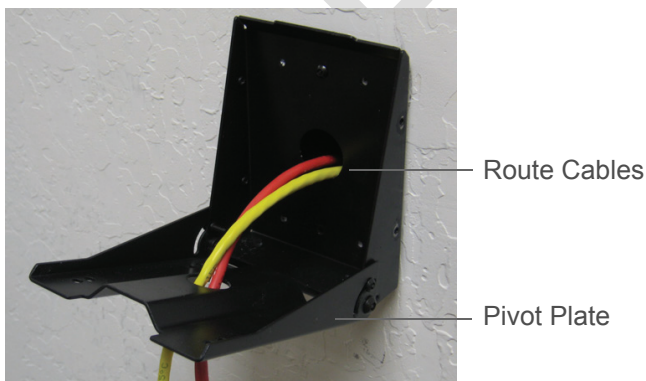

Figure 1-14 VESA Bracket - Unattended Wall Mount

Note: The pivot plate attaches to the bottom of the MF4100 reader.

- 4 Attach the mounting base to the gang box using the two #6-32 pin hex screws provided in the hardware kit.
- 5 Install cables to the connectors of the MF4100.
See: [MF4100 Cable Ports](#) (Page: 7).
- 6 Place the security plate onto the MF4100, and then route the cables through the plate opening.

Note the orientation of the VESA bracket to the security plate.

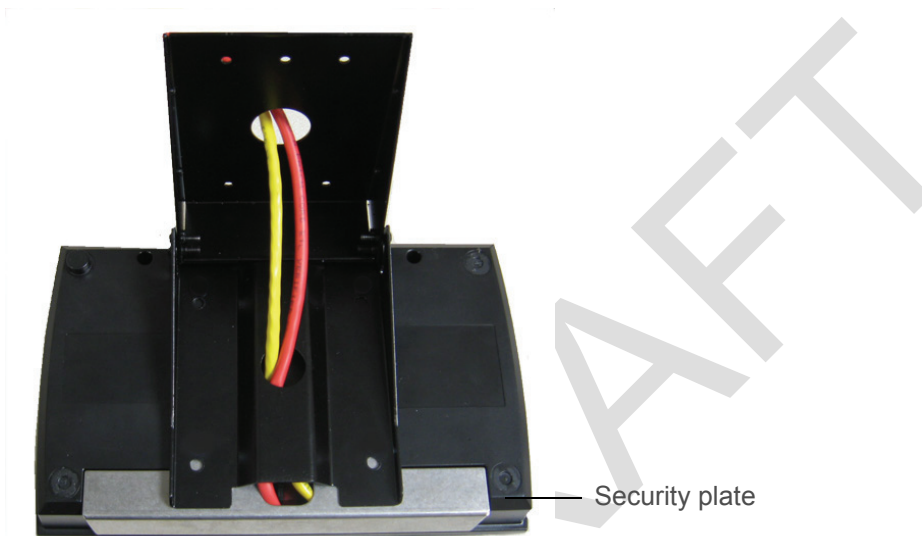

Figure 1-15 Unattended Wall Mount VESA Bracket Orientation

- 7 Place the MF4100 assembly on the pivot plate, and then secure using four M4 x 6mm machine screws provided in the hardware kit.
- 8 Position the pivot plate to the desired angle, and then tighten the 2 locking screws (1/8" pin hex driver).

TABLE TOP MOUNT INSTALLATION

MF4100 table top mounting installation options:

- [Table Top Mount With The VESA Mounting Bracket](#) (Page: 10)
- [Table Top Mount Without The VESA Mounting Bracket](#) (Page: 12)

Table Top Mount With The VESA Mounting Bracket

- 1 Find a location on a table or elsewhere to mount the MF4100.
Ensure there is enough clearance for the operator to access the touchscreen and swipe cards.
- 2 Install the rubber feet provided in the hardware kit to each corner of the base extensions.
The rubber feet are self-adhesive. Use the holes in the base extension to center each foot.

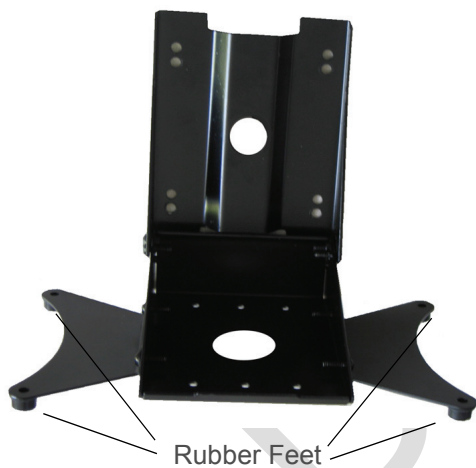

Figure 1-16 VESA Bracket Rubber Feet

- 3 Route the required cables through the VESA bracket cable hole, and then the pivot bracket hole.
- 4 Install cables to the connectors of the MF4100.
See: [MF4100 Cable Ports](#) (Page: 7).
- 5 Place the security plate onto the MF4100, and then route the cables through the plate opening.

For a fixed 15 degree angle, install the MF4100 so the security plate is located near the hinge of the VESA mounting bracket. Place the locking screws in the unattended position.

See: [VESA Bracket Screw Position - Unattended](#) (Page: 4)

For an adjustable angle, install the MF4100 so the speaker opening is located near the hinge of the VESA mounting bracket. Place the locking screws in the attended position.

See: [VESA Bracket Screw Position - Attended](#) (Page: 3)

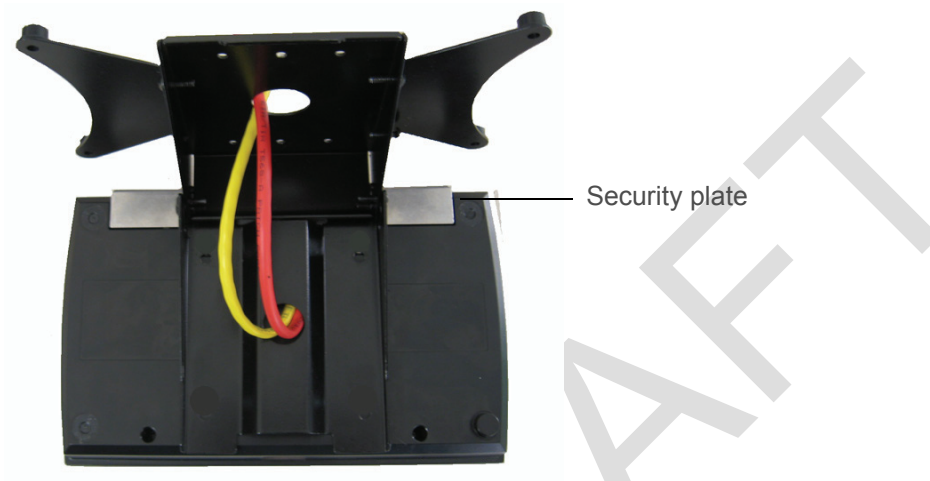

Figure 1-17 Table Top Mount - With VESA Bracket Cable Route

- 6 Secure the VESA bracket using four M4 x 6mm machine screws provided in the hardware kit.
- 7 Tighten the 2 locking screws (1/8" pin hex driver).

Table Top Mount Without The VESA Mounting Bracket

- 1 Find a location on a table or elsewhere to mount the MF4100.
Ensure there is enough clearance for the operator to access the touchscreen and swipe cards.
- 2 Install the rubber feet provided in the hardware kit to each corner of the MF4100 plastic bottom cover.
The rubber feet are self-adhesive. The bottom cover has round depressions in the plastic to locate the rubber feet. Install a rubber foot at each of the four corners.

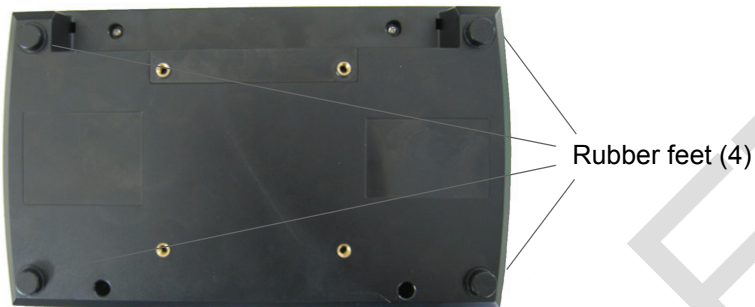

Figure 1-18 Reader Rubber Feet Installation Locations

- 3 Install the required cables to the connectors of the MF4100.
See: [MF4100 Cable Ports](#) (Page: 7).
- 4 Place the security plate onto the MF4100, and then route the cables through the opening.

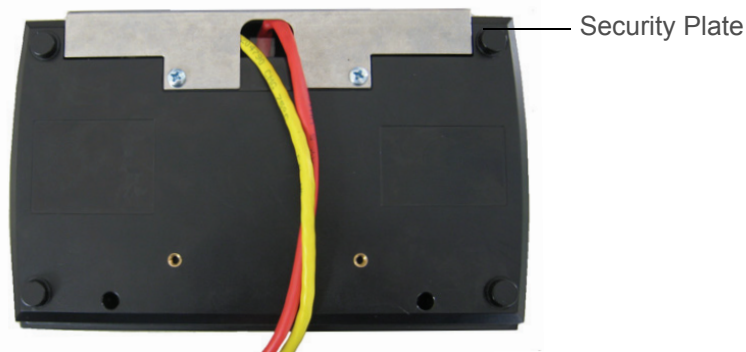

Figure 1-19 Table Top Mount - No VESA Bracket Cable Route

- 5 Secure the security plate onto the MF4100 using two M4 x 6mm machine screws provided in the hardware kit.

MF4100 FEATURES AND SPECIFICATIONS

FEATURES:

- Host communications via 10/100 Base-T ethernet (IP) or 802.11 b/g wireless
- Encrypted and authenticated IP communications
- VESA mounting bracket for table top or wall mount installation
- Display visible in all light conditions with adjustable backlight level
- Displays balance, account warnings, and other messages after transactions
- 5.7" VGA TFT-LCD panel
- Configuration via touchscreen/display, CONFIG port or web server
- Touchscreen configuration access can be disabled
- Adjustable volume setting

SPECIFICATIONS:

Physical Size: **9.0" W x 5.5"H x 2.21" D (without bracket) 1.7 pounds**

Input Power: **12 VDC 750 mA max (max 9W) - DC Input Voltage**
36-57 VDC - POE Input Voltage

Operating : **Temperature: 0 to + 60 degrees Celsius**
Relative Humidity: 0 to 95 percent, non-condensing
Altitude: 0 -10,000 feet

Non-Operating: **Temperature:-20 to + 70 degrees Celsius**
Relative Humidity: 0 to 95 percent, non-condensing
Altitude: 0 - 35,000 feet