



Car Radio | CD | USB | SD | Bluetooth

Hamburg 420 BT

1 011 202 422 / 1 011 202 423

Frankfurt 320

1 011 202 322 / 1 011 202 323



www.blaupunkt.com

Operating and installation instructions

 **BLAUPUNKT**

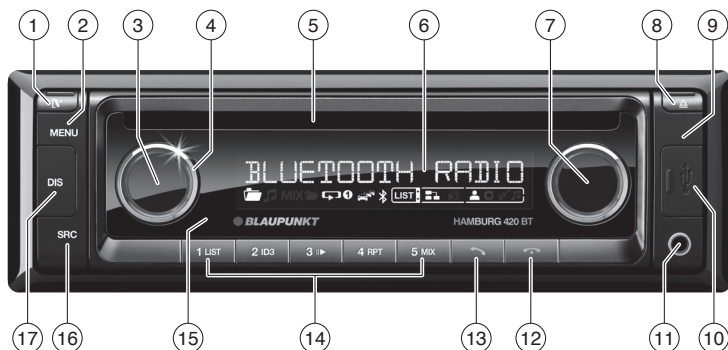

- ① **🔒** button
Unlock the detachable control panel
- ② **MENU** button
Short press: Call up/close menu
Long press: Start scan function
- ③ On/Off button
Short press: Switch on car sound system
In operation: Mute car sound system (Mute)
Long press: Switch off car sound system
- ④ Volume control
- ⑤ CD tray
- ⑥ Display
- ⑦ Rotary control
In the menu: Change menu level, select menu item, change setting
Radio mode: Set frequency, start station/PTY seek tuning
CD/MP3/WMA/iPod mode: Track selection, fast forward/reverse
Browse mode in MP3/WMA/iPod mode: ID3 category (iPod only), select folder and track
- ⑧ **⏏** button (Eject)
Eject a CD
- ⑨ Microphone (Hamburg 420 BT only)
- ⑩ USB port
- ⑪ Front AUX-IN socket
- ⑫ **📞** button (only Hamburg 420 BT)
Ending/rejecting a phone call
- ⑬ **📞** button (Hamburg 420 BT only)
Short press: Answering a call, speed dial
Long press: Open the phone book of the cell phone or activate voice dialing
- ⑭ Keys **1 - 5**
- ⑮ Infrared receiver
- ⑯ **SRC** button
Select memory bank or audio source
- ⑰ **DIS** button
Short press: Switch display
Long press: Switch display brightness
- ⑱ SD card slot
Access only with detached control panel



Safety notes	4	Scanning all tracks	12
Symbols used	4	Playing tracks in random order	13
Road safety	4	Repeatedly playing individual tracks or directories	13
General safety notes	4	Configuring the display	13
Declaration of conformity	5	Browse mode	14
Cleaning notes	5	Searching by track names (not in iPod mode)	15
Disposal notes	5	Bluetooth®	
Scope of delivery	5	(Hamburg 420 BT only)	15
Optional equipment (not part of the scope of delivery)	5	Bluetooth® menu	15
Placing the device in operation	5	Pairing and connecting a device	16
Attaching/detaching the control panel	5	Telephone functions	17
Display language (only Hamburg 420 BT)	6	Bluetooth® streaming mode	20
Setting the reception area	6	Phone book functions	20
Switching on/off	6	Additional functions in the Bluetooth® menu	21
Volume	6	External audio sources	23
Display brightness	7	Front AUX-IN socket	23
Switching demo mode on/off	7	Sound settings	23
Traffic information	7	Calling and exiting the "AUDIO" menu	23
Radio mode	7	Making settings in the "AUDIO" menu	24
RDS	7	Setting the 3-band equaliser	25
Changing to radio mode or selecting a memory bank	8	User settings	26
Tuning into a station	8	Calling the user menu and selecting a menu	26
Storing stations or calling stored stations	8	Making settings in the "TUNER" menu	27
Scanning stations	8	Making settings in the "DISPLAY" menu	28
Storing stations automatically (Travelstore) ...	9	Making settings in the "VOLUME" menu	29
PTY	9	Making settings in the "CLOCK" menu	30
Configuring the display	10	Making settings in the "VARIOUS" menu	30
CD/MP3/WMA/iPod mode	10	Factory settings	31
Basic information	10	Useful information	32
Changing to CD/MP3/WMA/iPod mode	11	Warranty	32
Inserting/ejecting a CD	11	Service	32
Connecting/removing a USB data carrier	11	Technical data	32
Inserting/removing the memory card	12	Installation instructions	33
Selecting tracks	12		
Fast searching	12		
Interrupting playback	12		

Safety notes

The car sound system was manufactured according to the state of the art and established safety guidelines. Even so, dangers may occur if you do not observe the safety notes in these instructions.

These instructions contain important information to easily and safely install and operate the car sound system.

- Read these instructions carefully and completely before using the car sound system.
- Keep the instructions at a location so that they are always accessible to all users.
- Always pass on the car sound system to third parties together with these instructions.

In addition, observe the instructions of the devices used in conjunction with this car sound system.

Symbols used

These instructions employ the following symbols:



DANGER!

Warns about injuries



CAUTION!

Warns about damaging the CD drive



DANGER!

Warns about high volume



The CE mark confirms the compliance with EU directives.

➔ Identifies a sequencing step

- Identifies a listing

Road safety

Observe the following notes about road safety:

- **Use your device in such a way that you can always safely control your vehicle.** In case of doubt, stop at a suitable location and operate your device while the vehicle is standing.
- **Remove or attach the control panel only while the vehicle is standing.**
- **Always listen at a moderate volume** to protect your hearing and to be able to hear acoustic warning signals (e.g. police sirens). During mute phases (e.g. when changing the audio source), changing the volume is not audible. Do not increase the volume during this mute phase.

General safety notes

Observe the following notes to protect yourself against injuries:

- **Do not modify or open the device.** The device contains a Class 1 laser that can cause injuries to your eyes.
- **Do not increase the volume during mute phases**, e.g. when changing the audio source. Changing the volume is not audible during a mute phase. Do not increase the volume during mute phases, e.g. when changing the audio source.

Use as directed

This car sound system is intended for installation and operation in a vehicle with 12 V vehicle system voltage and must be installed in a DIN slot. Observe the performance limits in the technical data. Repairs and installation, if necessary, should be performed by a specialist.

Installation instructions

You may only install the car sound system yourself if you are experienced in installing car sound systems and are very familiar with the electrical system of the vehicle. For this purpose, observe the installation instructions at the end of these instructions.

Declaration of conformity

The Blaupunkt AudioVision GmbH & Co. KG declares that the car sound system Frankfurt 320 complies with the basic requirements and the other relevant regulations of the directive 2004/108/EEC and the car sound system Hamburg 420 BT complies with the basic requirements and the other relevant regulations of the directive 1999/5/EC.

The declaration of conformity can be found on the Internet under www.blaupunkt.com.

Cleaning notes

Solvents, cleaning and scouring agents as well as dashboard spray and plastics care product may contain ingredients that will damage the surface of the car sound system.

- Use only a dry or slightly moistened cloth for cleaning the car sound system.
- If necessary, clean the contacts of the control panel regularly using a soft cloth moistened with cleaning alcohol.

Disposal notes



Do not dispose of your old unit in the household trash!

Use the return and collection systems available to dispose of the old device.

Scope of delivery

The scope of delivery includes:

- 1 Car sound system
- 1 Operating/installation instructions
- 1 Case for the control panel
- 1 Support frame
- 1 Antenna connection adapter

Extended scope of delivery

(for 1 011 202 323 / 1 011 202 423 only):

- 1 Handheld remote control (incl. battery)
- 1 Connecting cable chamber A
- 1 Connecting cable chamber B

Optional equipment (not part of the scope of delivery)

Use only accessories approved by Blaupunkt. Information is available from your Blaupunkt specialised dealer or on the Internet under www.blaupunkt.com.

Placing the device in operation

Caution!

Transport securing screws

Before the startup of the car sound system, ensure that the transport securing screws are removed (see the chapter "Installation instructions").

Attaching/detaching the control panel

The car sound system is equipped with a detachable control panel (release panel) to protect your equipment against theft. In the delivery state, the control panel is in the supplied case. To start operating the radio after installation, you must first attach the control panel (see the section "Attaching the control panel" in this chapter).

Always take the control panel with you when leaving the vehicle. The car sound system is worthless to a thief without this control panel.

Caution

Damage to the control panel

Never drop the control panel.

Transport the control panel so that it is protected against impacts and the contacts cannot become dirty.

Do not expose the control panel to direct sunlight or another heat source.

Avoid direct skin contact with the control panel's electrical contacts.

Attaching the control panel

- Push the control panel into the bracket at the right edge of the device.
- Push the control panel carefully into the left bracket until it clicks into place.

Removing the control panel

- Press the **[V]** button ① to unlock the control panel.
The left side of the control panel detaches from the device and is secured by the bracket against falling out.
- Move the control panel slightly to the left until it disengages from the right bracket.
- Carefully remove the control panel from the left bracket.

Note:

The car sound system automatically switches off as soon as the control panel is removed.

Display language (only Hamburg 420 BT)

For the Hamburg 420 BT, you can define whether the language for messages on the display is English or German. The setting is performed in the user menu (see the chapter "User settings", section "Making settings in the "DISPLAY" menu", menu item "LANGUAGE").

Setting the reception area

This car sound system is designed for operation in different regions with different frequency ranges and station technologies. The factory default of the reception area is "EUROPE". In addition, the reception areas "USA", "SOUTH AMERICA" and "THAILAND" are available.

Note:

If you operate the car sound system outside of Europe, you may first have to set a suitable reception area in the user menu (see the chapter "User settings", section "Making settings in the "TUNER" menu", menu item "TUNER AREA").

Switching on/off

Switching on/off with the On/Off button

- For switch-on, press the On/Off button ③.
The car sound system switches on.
- To switch off the device, press and hold down the On/Off button ③ for longer than 2 seconds.
The car sound system switches off.

Note:

If you switch on the car sound system while the vehicle ignition is switched off, it automatically switches off after 1 hour to preserve the vehicle battery.

Switching on/off via vehicle ignition

The car sound system will switch off/on simultaneously with the ignition if the device is correctly connected to the vehicle's ignition as shown in the installation instructions and you did not switch the device off by pressing the On/Off button ③.

Volume

Adjusting the volume

You can adjust the volume in steps from 0 (off) to 50 (maximum).

- Turn the volume control ④ to change the volume.

Note:

If a telephone or navigation system is connected with the car sound system as described in the installation instructions (pin 2 of chamber A), the car sound system is muted in case of a telephone call or navigation announcement so that you can hear the playback of the telephone or navigation system undisturbed. During muting, the display shows "TELEPHONE".

Muting the car sound system (Mute)

- Briefly press the On/Off button ③ to mute the car sound system or to reactivate the previous volume.

While it is muted, the display shows "MUTE".

Display brightness

You can manually switch the display brightness between daytime mode and night-time mode or switch automatically with the driving lights of the vehicle.

Note:

The manual or automatic switching of the display brightness is selected in the user menu (see the chapter "User settings", section "Making settings in the "DISPLAY" menu", menu item "DIMMER").

➔ Press the **DIS** button (17) for approx. 2 seconds to start scanning.

Switching demo mode on/off

The demo mode shows the functions of the car sound system as scrolling text on the display. By pressing any button, the demo mode is interrupted and you can operate the device.

The demo mode can be switched on and off in the user menu (see the chapter "User settings", section "Making settings in the "VARIOUS" menu", menu item "DEMO MODE").

Traffic information

In the reception area "EUROPE", an FM station can identify traffic reports by means of an RDS signal. If priority for traffic reports is switched on, a traffic report is automatically switched through, even if the car sound system is currently not in radio mode.

If priority is switched on, the display shows the traffic jam symbol (🚧). "TRAFFIC" is displayed during a switched-through traffic announcement.

The priority is activated and deactivated in the user menu (see the chapter "User settings", section "Making settings in the "TUNER" menu", menu item "TRAFFICINFO").

Notes:

- The volume is increased for the duration of the switched-through traffic announcement. You can adjust the minimum volume

for traffic announcements (see the chapter "User settings", section "Making settings in the "VOLUME" menu", menu item "TRAFFIC VOL").

- To cancel a switched-through traffic announcement, press the **SRC** button (16).

Radio mode

RDS

Many FM stations broadcast an RDS (Radio Data System) signal in addition to their programme in the reception area "EUROPE" that allows the following additional functions:

- The station name is shown on the display.
- The car sound system recognises traffic announcements and news broadcasts and can automatically switch them through in other operating modes (e.g. in CD mode).
- Alternate frequency: If RDS is activated, the car sound system automatically selects the best receivable frequency for the station that is currently set.
- Regional: At certain times, some radio stations divide their programme into regional programmes providing different content. If the REGIONAL function is activated, the car sound system changes only to those alternate frequencies on which the same regional programme is being broadcast.

The functions RDS and REGIONAL are activated and deactivated in the user menu (see the chapter "User settings", section "Making settings in the "TUNER" menu", menu items "RDS" and "REGIONAL").

Note:

If you adjust a different reception area than "EUROPE", RDS is automatically switched off. The station name continues to be shown on the display. If you want to use radio stations with RDS features in your region, switch on RDS in the user menu.

Changing to radio mode or selecting a memory bank

The following memory banks are available in the different reception areas:

Region	Memory banks
EUROPE	FM1, FM2, FMT, MW, LW
USA	FM1, FM2, FMT, AM, AMT
SOUTH AMERICA	FM1, FM2, FMT, AM, AMT
THAILAND	FM1, FM2, FMT, AM, AMT

➤ Press the **SRC** button (16) repeatedly until the desired memory bank is displayed.

Notes:

- Up to 5 stations can be stored in each memory bank.
- You can disable certain memory banks that you do not want to use (see chapter "User settings", section "Making settings in the "TUNER" menu", menu item "BAND SELECTION"). Deactivated memory banks are skipped during the source selection with the **SRC** button (16).

Tuning into a station

There are various ways of tuning into a station:

Starting station seek tuning

➤ Turn rotary control (7) one notch counter-clockwise or clockwise to start station seek tuning.

The display briefly shows "SEARCH AUTO". The radio tunes into the next receivable station.

Notes:

- For the reception area "EUROPE": In the FM waveband, only traffic information stations are tuned into if the priority for traffic information (🚚) is switched on.
- The sensitivity of seek tuning can be adjusted (see the chapter "User settings", section "Making settings in the "TUNER" menu", menu item "SENSITIVITY").

Tuning into stations manually

➤ Press the rotary button (7) once to activate manual station tuning.

The display briefly shows "SEARCH MANUAL".

➤ Turn the rotary control (7) to change the frequency in increments.

Note:

The manual station tuning is automatically exited approx. 15 seconds after the last frequency change, and the station seek tuning is started by turning the rotary control (7).

Storing stations or calling stored stations

➤ Select the desired memory bank.

➤ If necessary, set the desired station.

➤ Press the station button **1 - 5** (14) for approx. 2 seconds to store the current station under the button.

- or -

➤ Briefly press the station button **1 - 5** (14) to call up the stored station.

Scanning stations

With the scan function, you can scan either every receivable station or every stored station of the current waveband.

Note:

You can adjust the scan time for each station (see the chapter "User settings", section "Making settings in the "VARIOUS" menu", menu item "SCAN TIME").

Scanning all receivable stations of the waveband

➤ Press the **MENU** button (2) for approx. 2 seconds to start scanning.

During the scan, the display alternately displays "SCAN" and the current frequency as well as memory bank or station name.

➤ Briefly press the **MENU** button (2) to continue listening to the station that is currently being scanned.

Scanning all stored stations of the waveband

- Press the rotary control (7) for approx. 2 seconds to start the scanning.

During the scan, the display alternately displays the current frequency as well as memory bank and location or station name.

- Briefly press the rotary control (7) to continue listening to the station that is currently being scanned.

Storing stations automatically (Travelstore)

With Travelstore, you can automatically search for and store the 5 FM stations offering the strongest reception in the region in one memory bank. Any previously stored stations in this memory bank are deleted in the process.

With Travelstore, you can store 5 FM stations in the FMT memory bank in all reception areas. In the reception areas "USA", "SOUTH AMERICA" and "THAILAND", you can also store 5 AM stations in the AMT memory bank.

- Select a memory bank of the desired waveband, e.g. FM1 or AM.
- Press the **SRC** button (16) for approx. 2 seconds.

The tuner starts the automatic station seek tuning; the display shows "FM TSTORE" or "AM TSTORE". After the storing is completed, the radio plays the station at memory location 1 of the FMT or AMT level.

Notes:

- For the reception area "EUROPE": If the priority for traffic information is switched on () only traffic information stations are stored.
- If the FMT or AMT memory bank is deactivated (see the chapter "User settings", section "Making settings in the "TUNER" menu", menu item "BAND SELECTION"), it is automatically reactivated if you initiate the Travelstore function.

PTY

In the reception areas "EUROPE" and "USA", an FM station can transmit its current programme type, e.g. CULTURE, POP, JAZZ, ROCK, SPORT or SCIENCE. Hence, the PTY function allows a targeted search for broadcasts of a certain programme type, e.g. for rock or sports broadcasts. Note that PTY is not supported by all stations.

Note:

The PTY function is only available if it has been activated (see the chapter "User settings", section "Making settings in the "TUNER" menu", menu item "PTY").

Selecting a programme type

To select a programme type, read the section "Making settings in the "TUNER" menu", menu item "PTY TYPES" in the chapter "User settings".

Note:

In the reception area "EUROPE", you can adjust the language in which the programme types are displayed (see the chapter "User settings", section "Making settings in the "TUNER" menu", menu item "PTY LANGUAGE").

Searching for stations

Prerequisite: PTY function is switched on.

- Press the rotary control (7) twice.
The display briefly shows "SEARCH PTY".
- Turn rotary control (7) one notch counter-clockwise or clockwise to start the PTY seek tuning.

During the seek tuning, "SEARCH" and the currently selected programme type are shown on the display.

As soon as a station with the desired programme type is found, it remains being tuned into.

Notes:

- If no station with the selected programme type is found, "NO PTY" is briefly displayed and 2 beeps can be heard. The radio will then retune to the station that it played last.

- If the tuned radio station or another station on the broadcasting network broadcasts your selected programme type at a later point in time, the car sound system will automatically switch from the currently tuned station or from the current audio source (e.g. CD) to the station whose programme type matches the one you selected. Note that this function is not supported by all stations.

Configuring the display

- ➔ Press the **DIS** button  to toggle between these displays:

Display	Meaning
ABCDEF	Station name
FM1 P1 89.90	Memory bank/memory location/frequency
FM1 P1 08:40	Memory bank/memory location/time

CD/MP3/WMA/iPod mode

Basic information

CD/MP3/WMA mode

This car sound system can be used to play audio CDs (CDDA) and CD-R/RWs with audio, MP3 or WMA files as well as MP3 or WMA files on USB data carriers and SD(HC)/MMC memory cards.

Notes:

- To ensure proper functioning, use only CDs with the Compact-Disc logo.
- Blaupunkt cannot guarantee the flawless function of copy-protected CDs and all CD blanks, USB data carriers and memory cards available on the market.

Note the following information when preparing an MP3/WMA data carrier:

- Naming of tracks and directories:
 - Max. 32 characters without the file extension ".mp3" or ".wma" (the use of more

characters reduces the number of tracks and folders that the car sound system can recognise)

- No umlauts or special characters
- CD formats: audio CD (CDDA), CD-R/RW, Ø: 12 cm
- CD data formats: ISO 9669 Level 1 and 2, Joliet
- CD burn speed: Max. 16x (recommended)
- USB format/file system: Mass storage device/FAT16/32
- Memory card file system: FAT16/32
- File extension of audio files:
 - .MP3 for MP3 files
 - .WMA for WMA files
- WMA files only without Digital Rights Management (DRM) and created with Windows Media Player version 8 or later
- MP3 ID3 tags: Version 1 and 2
- Bitrate for creating audio files:
 - MP3: 32 to 320 kbps
 - WMA: 32 to 192 kbps
- Maximum number of files and directories: Up to 30,000 files/500 directories depending on the data structure

iPod mode

You can connect numerous iPod and iPhone models to the car sound system via the USB port in the front of the device and the USB port at the rear and control the audio playback from the car sound system.

Notes:

- Blaupunkt cannot guarantee the flawless function of all iPod and iPhone models.
- If an iPhone and iPod are connected at the same time, the devices are charged via the USB ports. If two iPhones are connected at the same time, charging is not possible.

Use a suitable adapter cable to connect your iPod or iPhone with the USB port of the car sound system.

Changing to CD/MP3/WMA/iPod mode

- Press the **SRC** button (16) repeatedly until the desired audio source is displayed:
 - "CD": Inserted CD.
 - "SD(HC)": Inserted memory card
 - "USB FRONT" or "USB REAR": USB data carrier connected to the front or rear.
 - "IPOD FRONT" or "IPOD REAR": iPod connected to the front or rear
 - "AUX": Connected external audio source.

Notes:

- The respective audio source can be selected only if a corresponding CD is inserted or a corresponding device is connected.
- A connected iPod is initially selected under "USB" and, as soon as the iPod is recognised, under "IPOD".
- If the car sound system first has to read the data of a connected device or data carrier before the playback, the display shows "READING". The duration of the reading depends on the data volume and design of the device or data carrier. If the device or data carrier is defective or the transferred data cannot be played back, a corresponding message appears on the display (e.g. "CD ERROR").

Inserting/ejecting a CD

Inserting a CD



Risk of severe damage to the CD drive!

Noncircular contoured CDs (shape CDs) and CDs with a diameter of 8 cm (mini CDs) must not be used.

We accept no responsibility for any damage to the CD drive that may occur as a result of the use of unsuitable CDs.

Note:

You must not hinder or assist the drive as it automatically draws in the CD.

- Insert the CD with its printed side up into the CD tray (5) until you feel a slight resistance.

The drive automatically draws in the CD and checks its data. Afterwards, the playback starts in CD or MP3 mode.

Note:

If the inserted CD cannot be played back, "CD ERROR" is briefly displayed and the CD is automatically ejected after approx. 2 seconds.

Ejecting a CD

Note:

You must not hinder or assist the drive as it ejects the CD.

- Press the **▲** button (8) to eject an inserted CD.

Notes:

- If a CD is ejected and not removed, the drive will automatically draw it back in again after approx. 10 seconds.
- You can also eject CDs while the car sound system is switched off or whilst another audio source is activated.

Connecting/removing a USB data carrier

Note:

You can connect USB data carriers to the USB port at the front of the device as well as the rear USB port.

Connecting a USB data carrier

- Switch off the car sound system so that the data carrier will be correctly registered.
- First, pull the protective cap of the USB port (10) to the front until it moves out of the port and fold it to the right to connect a data carrier to the USB port at the front of the device.
- Connect the USB data carrier.
- Turn on the car sound system.

If the USB data carrier is initially selected as audio source, the data are read first.

Notes:

- If the connected USB data carrier cannot be seen, "USB ERROR" is briefly displayed.
- The time required for reading in the data depends on the design and size of the USB data carrier.

Removing a USB data carrier

- Switch off the car sound system so that the data carrier will be correctly unregistered.
- Disconnect the USB data carrier.
- After you pulled off the data carrier from the USB port at the front of the device, close the protective cap of the USB port (10).

Inserting/removing the memory card

Inserting the memory card

- Detach the control panel.
- Insert the memory card with its labelled side up and its contacts first into the card slot (18) until it clicks into place.
- Attach the control panel.

After switch-on, the device automatically selects the inserted memory card as audio source. The data of the memory card are being read. Afterwards, the playback starts in MP3 mode.

Notes:

- If the inserted memory card cannot be played, "SD ERROR" is briefly displayed.
- The time required for reading the card depends on the design and size of the memory card.

Removing the memory card

- Detach the control panel.
- Push on the memory card until it disengages.
- Pull the memory card out of the card slot (18).
- Attach the control panel.

Selecting tracks

- Turn rotary control (7) one notch counter-clockwise or clockwise to change to the previous/next track.

Notes:

- If you turn rotary control (7) several notches counter-clockwise or clockwise, you jump forward or reverse by the corresponding number of tracks.
- If the current track plays longer than 3 seconds and you turn rotary control (7) by one notch counter-clockwise or clockwise, the tracks starts playing again.

Fast searching

- Press the rotary control (7) once. The display briefly shows "CUE/REVIEW".
- Turn the rotary control (7) until the desired position has been reached.

Note:

If you press the rotary control (7) twice, the display briefly shows "TRACK SELECT". By turning the rotary control (7), you select a different track.

Interrupting playback

- Press the 3 button (14) to interrupt the playback ("PAUSE") or to continue it.

Scanning all tracks

The scan function scans all available tracks.

- Press the rotary control (7) for approx. 2 seconds to start the scan, or briefly to continue playing the currently scanned track.

During the scan, the display alternately displays "SCAN" and the current track number or file name.

Note:

The scan time can be adjusted (see the chapter "User settings", section "Making settings in the "VARIOUS" menu", menu item "SCAN TIME").

Playing tracks in random order

- Press the **5 MIX** button (14) to change among the playback modes:



Operation	Display	Meaning
CD/ iPod	MIX ALL	Mixing tracks
MP3/ WMA	MIX FOLDER	Mixing tracks of the current folder
	MIX ALL	Mixing tracks of the data carrier
Gen.	MIX OFF	Regular playback

If the MIX function is switched on, the icon **MIX** (mix all tracks) or **MIX**  (mix tracks of current folder) is shown on the display.

Repeatedly playing individual tracks or directories











- Press the **4 RPT** button (14) to change among the playback modes:

Operation	Display	Meaning
CD/ iPod	REPEAT TRACK	Repeating tracks
MP3/ WMA	REPEAT TRACK	Repeating tracks
	REPEAT FOLDER	Repeating folders
Gen.	REPEAT OFF	Regular playback

If the REPEAT function is switched on, the icon  (repeat tracks) or  (repeat folders) is shown on the display.

Configuring the display

- Press the **DIS** button (17) once or several times to toggle between these displays:

Operation	Display / icon	Meaning
CD	TRACK 01 00:15	Track number and playing time
	TRACK 01 03:37	Track number and duration
	TRACK 01 08:40	Track number and time
MP3/ WMA/ iPod	ABCDEF / 	File name ²
	ABCDEF / 	Track name ¹
	ABCDEF / 	Artist ¹
	ABCDEF / 	Album ¹
	ABCDEF / 	Genre ³
	PLAY TIME 00:15	Playing time
	TOTAL TIME 03:37	Track duration
	ALL INFO /     	All information as scrolling text

¹ Track name, artist and album name must be stored as ID3 tag to be able to display them.

² The file name is displayed only in MP3/WMA mode.

³ The genre information is available only on iPod mode.

Note:

With every track change, the file name is briefly shown in MP3/WMA mode and the track name in iPod mode before the display switches to the defined display.



Browse mode

In Browse mode, you can directly search for and select a certain track on the MP3/WMA data carrier or iPod without interrupting the current playback.

Browse mode in MP3/WMA mode

In MP3/WMA mode, you can select and play a track from a directory of the data carrier.

- Briefly press the **1 LIST** button (14) to call up the browse mode in MP3/WMA mode.

The display shows the  icon. The first or current folder on the data carrier and the  icon are displayed.

Notes:

- The first folder is displayed only if the browse mode has been called for the first time after inserting or connecting the data carrier. Afterwards, the current folder is displayed whenever the browse mode is called.
- The browse mode remains switched on for 5 minutes without confirming a selection.
- You can exit the browse mode at any time by pressing the **1 LIST** button (14).
- Turn the rotary control (7) to select a different folder.
- Press the rotary control (7) to display the tracks of the selected folder.
The first track of the folder and the  icon are shown on the display.
- Note:**
To return to the folder list, turn the rotary control (7) until the "<<<" option is selected and press the rotary control (7).
- Turn the rotary control (7) to select a different track.
- Press the rotary control (7) to play the track.
The playback starts. You are exiting the browse mode.



Browse mode in iPod mode

In iPod mode, you can select and play the tracks via the categories "ARTISTS", "ALBUMS", "GENRES" or "PLAYLISTS".

- Press the **2 ID3** button (14) to call up the Browse mode in the iPod mode.

The display shows the  icon. The first category, "ARTISTS", is displayed.

Notes:

- Press the **2 ID3** button (14) for approx. 2 seconds to directly call up the "PLAYLISTS" category.
- The browse mode remains switched on for 5 minutes without confirming a selection.
- You can exit the browse mode at any time by pressing the **2 ID3** button (14).
- Turn the rotary control (7) to select the category "ALBUMS" , "GENRES"  or "PLAYLISTS" .
- Press the rotary control (7) to display the available folders of the category.
The first folder of the selected category is shown on the display (e.g. "JAZZ" in the "GENRES" category).
- Note:**
To return to the list of categories, turn the rotary control (7) until the "<<<" option is selected and press the rotary control (7).
- Turn the rotary control (7) to select a different folder.
- Press the rotary control (7) to display the available tracks of the folder.
The first track of the folder is shown on the display.
- Note:**
To return to the folder list, turn the rotary control (7) until the "<<<" option is selected and press the rotary control (7).
- Turn the rotary control (7) to select a different track.

- Press the rotary control (7) to play the track.
The playback starts. You are exiting the browse mode.

Searching by track names (not in iPod mode)

On MP3/WMA data carriers, you can find a track based on its file name and start the playback.

- Press the **1 LIST** button (14) for approx. 2 seconds to start the search function.

You can now enter a file name with up to 16 characters:

Notes:

- You do not have to enter the complete file name. You can enter only the first characters of the file name and select the desired track from the list of tracks found.
- You can exit the search function at any time by briefly pressing the **1 LIST** button (14).
- Turn the rotary control (7) to select a character for the respective position.
- Press the rotary control (7) to go to the next position.
- Press the **1 LIST** button (14) for approx. 2 seconds to start the search.
All tracks corresponding to the file name entered are listed.
- If necessary, turn the rotary control (7) to select a track.
- Press the rotary control (7) to start the playback.

Bluetooth® (Hamburg 420 BT only)

You can connect the Hamburg 420 BT via Bluetooth® with other Bluetooth®-ready devices, such as cell phones or MP3 players. This allows you to use the car sound system with its integrated microphone as hands-free system for connected cell phones and control the audio output of other Bluetooth® devices and play them back via the loudspeakers of the car sound system (Bluetooth® streaming).

Note:

You can also connect an external microphone for hands-free calling (see the chapter "Installation instructions").

Bluetooth® technology is a wireless connection of short range. For this reason, Bluetooth® devices must be located near the car sound system (in the vehicle) to establish and maintain a connection. To establish a Bluetooth® connection, you must first pair the car sound system and the Bluetooth® device. When you pair the devices, a Bluetooth® connection is subsequently established automatically. This connection remains in effect as long as the Bluetooth® device is within range. If the connection is interrupted, e.g. because you moved the cell phone outside the range, the connection is automatically re-established as soon as you are back within range.

You can connect only one cell phone and streaming device with the car sound system at a time. If you connect a new device with the car sound system, the connection to a currently connected device may automatically be interrupted. However, the car sound system leaves up to 5 different Bluetooth® devices paired, and you can quickly and easily connect any of these devices with the car sound system again.

Bluetooth® menu

In the Bluetooth® menu, you find all the functions for pairing, connecting and managing Bluetooth® devices.

Calling the Bluetooth® menu

- Briefly press the **MENU** (2) button to open the user menu.
- Turn the rotary control (7) until the "BLUETOOTH" menu item is selected.
- Press the rotary control (7) to open the Bluetooth® menu.
- Turn the rotary control (7) until the desired menu item is selected.
- Perform the setting (see the following sections).
- Briefly press the **MENU** button (2) to exit the menu.

Notes:

- The Bluetooth® menu is automatically exited approx. 60 seconds after the last button activation and you are returned to the display of the current audio source.
- To go back to the next higher-level menu, turn the rotary control (7) until the "<<<" option is selected and press the rotary control (7).
- If a Bluetooth® process is running (e.g. re-establishing the connection to the last connected device), the functions of the Bluetooth® menu are blocked. If you attempt to open the Bluetooth® menu during this time, "LINK BUSY" briefly appears on the display. If you want to cancel the Bluetooth® process and open the Bluetooth® menu, press the  button (12).

Pairing and connecting a device

Note:

You can pair up to 5 Bluetooth® devices with this car sound system. Before you can pair a sixth device, you must first unpair one of the 5 already paired devices (see ch. "Additional functions in the Bluetooth® menu", section "Managing paired devices"). If you should attempt to pair a sixth Bluetooth® device, "PHONE LIST FULL – PLEASE DELETE ENTRIES FROM LIST" is displayed.

Pairing and connecting a cell phone

Note:

If a connection with a cell phone currently exists, this connection is automatically disconnected if you pair and connect another cell phone.

- In the Bluetooth® menu, select the "PAIRING" menu item.
- Press the rotary control (7) to open the menu. The "MOBILE PHONE" menu item is selected.
- Press the rotary control (7) to register a cell phone.

The display shows "PAIRING" and the Bluetooth® symbol  is flashing. The car sound system can now be recognised by a Bluetooth® cell phone for approx. 2 minutes and connected.

- Search the car sound system from your cell phone (Bluetooth® name: "BP 420 BT").

As soon as the car sound system is located by the cell phone and is to be connected, the display briefly shows "ENTER PIN" and the currently stored PIN (by default "1234").

- Establish the connection from your cell phone. Enter the PIN displayed by the car sound system.

The display may show "PAIRED", followed by "CONNECTED", as soon as the car sound system and the cell phone are paired and connected.

Notes:

If no connection can be established, the display briefly shows "CONNECT FAILED".

Pairing and connecting a Bluetooth® streaming device

Note:

If a connection with a streaming device currently exists, this connection is automatically disconnected if you pair and connect another streaming device.

- In the Bluetooth® menu, select the "PAIRING" menu item.
- Press the rotary control (7) to open the menu. The "MOBILE PHONE" menu item is selected.
- Turn the rotary control (7) to select the "STREAMING" menu item.
- Press the rotary control (7) to register a streaming device.

The display shows the currently stored PIN (default "1234"). If required, enter the PIN of the streaming device:

- Turn the rotary control (7) to select a digit for the respective position.
- Press the rotary control (7) to go to the next position.

Notes:

- To return to the previous position for the PIN entry, turn the rotary control (7) until the "<<<" option is selected, and press the rotary control (7).
- Not all streaming devices require the entry of a PIN on the car sound system. For some streaming devices, you have to enter the PIN of the car sound system instead. For these devices, press only the rotary control (7) repeatedly until you reach beyond the last position, thereby confirming the current PIN, and then enter this PIN on the streaming device.

The display shows "PAIRING" and the Bluetooth® symbol  is flashing. The car sound system can now be recognised by the streaming device for approx. 2 minutes and connected.

- Search the car sound system from your streaming device (Bluetooth® name: "BP 420 BT") and establish the connection. Enter the PIN of the car sound system, if necessary.

The display may show "PAIRED", followed by "CONNECTED", as soon as the car sound system and the streaming device are paired and connected.

Notes:

- If no connection can be established, the display briefly shows "CONNECT FAILED".
- After switch-on, the car sound system automatically attempts to reconnect the device connected last. If the connection attempt fails, the display briefly shows "CONNECTION LOST". If necessary, attempt to re-establish the connection from the streaming device.



Telephone functions

Answering/rejecting an incoming phone call

With an incoming call, the display alternately shows "INCOMING CALL" and the number of the caller. The current audio source is muted and a ring tone is played via the loudspeakers of the car sound system.

Note:

If the number of the caller is not being transmitted, the display shows "PRIVATE NUMBER" instead of the number. If the number of the caller is stored together with a name, the name of the entry and the number are displayed (see the section "Storing a phone number in the car sound system" in this chapter).

- Press the  button (13) to answer the call. "CALL" and the duration of the ongoing call are displayed.
- Press the  (12) button to reject the call or to end the current call.

The display shows "CALL END".

Notes:

- During the call, you can adjust the volume with the volume control (4) or mute the device with a short press of the On/Off button (3).
- You can adjust the volume for the call playback in the user menu (see the chapter "User settings", section "Making settings in the "VOLUME" menu", menu item "HANDS-FREE VOL").

Making a call

➤ In the Bluetooth® menu, select the "DIAL NEW NUMBER" menu item.

➤ Press the rotary control (7) to open the entry menu.

You can now enter a phone number with up to 20 digits:

➤ Turn the rotary control (7) to select a digit for the respective position.

➤ Press the rotary control (7) to go to the next position.

Note:

To return to the previous position in the entry menu, turn the rotary control (7) until the "<<<<" option is selected, and press the rotary control (7).

➤ Press the  button (13) to call the number entered.

"CALLING" and the dialed number are alternately shown on the display.

As soon as your calling party answers the call, the display shows "CALL" and the time of the current phone call.

Upon ending the call, the display briefly shows "CALL END".

Calling an entry in the phone book

Note:

This function is available only if the phone book of the connected cell phone was transferred to the car sound system (see the chapter "Phone book functions").

➤ In the Bluetooth® menu, select the "PHONE-BOOK" menu item.

➤ Press the rotary control (7) to open the phone book.

The display shows the first phone book entry.

Note:

If the phone book has not yet been transferred, the display briefly shows "PHONE-BOOK NOT AVAILABLE".

➤ Turn the rotary control (7) to select a different entry.

➤ Press the rotary control (7) or the  button (13) to call the number.

"CALLING" and the dialed number are alternately shown on the display.

Note:

You can also call an entry in the phone book via speed dial (see the section "Speed dial for phone book entries" in this chapter).

Making a call with voice dial

Note:

This function is only available if the connected cell phone supports voice dial.

➤ In the Bluetooth® menu, select the "VOICE DIAL" menu item.

➤ Press the rotary control (7) or the  button (13) to activate voice recognition.

The car sound system is muted and the display shows "SPEAK NOW".

➤ Say the name of the desired calling partner.

Notes:

- If no Bluetooth® connection is established when voice recognition is activated, the display briefly shows "VOICE DIAL FAILED – NO BT CONNECTION".
- If the spoken name is not being recognised or the time for the voice recognition has already expired, the display briefly shows "DIAL FAILED".
- You can cancel the voice recognition by pressing the  button (12).
- Please note that the duration of the voice recognition is limited and depending on the respective cell phone.
- You can also activate the voice recognition via speed dial (see the section "Speed dial for voice dial" in this chapter).

Storing a phone number in the car sound system

You can store phone numbers in the car sound system and make calls using the speed dial (see the following section).

A phone number is stored for the currently connected telephone and is available only for this telephone. The car sound system can store up to five numbers for up to five paired devices.

- Enter the phone number as described in the section "Making a call".
- Press the desired memory button **1 - 5** (14) for approx. 2 seconds to store only the number.
- or -
- Press the rotary control (7) for approx. 2 seconds to enter a name for the entry.

You can now enter a name with up to 15 characters:

- Turn the rotary control (7) to select a character for the respective position.
- Press the rotary control (7) to go to the next position.

Note:

To return to the previous position in the entry menu, turn the rotary control (7) until the "<<<" option is selected, and press the rotary control (7).

- Press the desired memory button **1 - 5** (14) for approx. 2 seconds to store the number and name.

The display briefly shows "NUMBER SAVED". Afterwards, you are returned to the Bluetooth® menu and the "DIAL NEW NUMBER" menu item.

Notes:

- A number previously stored on the memory button is replaced.
- If a telephone is unpaired, the numbers stored for this telephone are automatically deleted.

Speed dial for any phone number or for the number dialed last or a stored number

With speed dial, you can make a call without first having to select the corresponding function in the Bluetooth® menu.

To call the number dialed last,
➤ press the  button (13).

The display shows the number dialed last.

Note:

If no cell phone is currently connected, the Bluetooth® menu is opened. The "PAIRING" menu item is selected.

- Press the  button (13) to call the number. "CALLING" and the dialed number are alternately shown on the display.

To call a stored number,

- press the  button (13).

- Press a memory button **1 - 5** (14) to call the number stored.

Note:

If no number is stored under the selected memory button, the display briefly shows "NO NUMBER".

- Press the  button (13) to call the number. "CALLING" and the dialed number are alternately shown on the display.

To call any number,

- press the  button (13).

- Press the On/Off button (3) to open the entry menu and enter a number (enter the phone number as described in the section "Making a call").

- Press the  button (13) to call the number. "CALLING" and the dialed number are alternately shown on the display.

Speed dial for phone book entries

Note:

This function is only available

- if the phone book of the connected cell phone was transferred to the car sound system (see the chapter "Phone book functions").
- if the speed dial is set for phone book entries (see the chapter "Additional functions in the Bluetooth® menu", section "Setting the button function for speed dial").

To select an entry of the phone book with the speed dial and call it,

- press the  button (13) for approx. 2 seconds.

The display shows the first phone book entry.

- If necessary, select another entry as described in the section "Calling an entry in the phone book".

- Press the  button (13) to call the number.

"CALLING" and the dialed number are alternately shown on the display.

Speed dial for voice dial

Note:

This function is only available

- if the connected cell phone supports voice dial.
- if the speed dial is set for voice dial (see the chapter "Additional functions in the Bluetooth® menu", section "Setting the button function for speed dial").

To activate the voice recognition with the speed dial,

- press the  button (13) for approx. 2 seconds.

The car sound system is muted and the display shows "SPEAK NOW".

- Say the name of the desired calling partner.

Bluetooth® streaming mode

Starting the Bluetooth® streaming mode

- Press the SRC (16) button repeatedly until "BT-STREAM" appears on the display.

The playback starts.

Notes:

- The Bluetooth® streaming mode can be selected only if a suitable streaming device is connected.
- If the connection to the streaming device is lost during playback, the display briefly shows "CONNECTION LOST" and the car sound system changes to the previous audio source.

Selecting tracks

- Turn rotary control (7) one notch counter-clockwise or clockwise to change to the previous/next track.

Interrupting playback

- Press the 3 button (14) to interrupt the playback ("PAUSE") or to continue it.

Phone book functions

Transferring the phone book of the cell phone to the car sound system

You can transfer the phone book of the connected cell phone to the car sound system to call entries of the phone book using the car sound system.

Notes:

- The car sound system accepts only entries from the memory of the telephone and not from the SIM card inserted in the telephone.
- The transfer does not delete the phone book from the cell phone.

The car sound system can store the phone books of the paired telephones with a total of up to 960 entries. If several numbers are stored on the telephone for one contact (e.g. landline, cell phone number, office number and similar), each number is stored as a separate entry by the car sound system.

Each entry consists of a name and a number, each up to 20 characters on digits.

Note:

Do not switch off the car sound system while transferring the phone book. If you do or if the power supply of the car sound system should be interrupted for any reason, you have to restart the transfer.

➤ In the Bluetooth® menu, select the "DOWN-LOAD P-BOOK" menu item.

➤ Press the rotary control (7).

The display shows "CONFIRM".

➤ Press the rotary control (7) again.

"PHONEBOOK DOWNLOADING – PLEASE WAIT" appears on the display.

After the download is complete, the display briefly shows "DOWNLD COMPLETE".

Notes:

- To cancel the transfer, press the  button (12).
- If the transfer of the phone book fails, the display briefly shows "DOWNLOAD FAILED".
- If the transfer of the phone book exceeds the storage capacity of the car sound system, the display briefly shows "PHONEBOOK FULL". The phone book entries transferred so far remain stored.
- If you supplemented or changed entries on your cell phone since the last transfer, you can update the phone book on the car sound system by transferring it again. If the storage capacity of the car sound system is exceeded in the process, first delete the already transferred phone book (see the next section) or unpair another cell phone, if necessary, so that its phone book is also deleted from the car sound system (see the chapter "Additional functions in the Bluetooth® menu", section "Managing paired devices").

- If you insert a CD during an ongoing transfer, the playback does not start until the transfer is completed.

Deleting the phone book of the cell phone from the car sound system

You can delete the phone book of the connected cell phone.

Note:

The telephone remains connected.

➤ In the Bluetooth® menu, select the "DELETE P-BOOK" menu item.

➤ Press the rotary control (7).

The display shows "CONFIRM".

➤ Press the rotary control (7) again.

Additional functions in the Bluetooth® menu

Changing the Bluetooth® PIN

The factory-set Bluetooth® PIN of the car sound system is "1234"; e.g. it must be entered on the cell phone when pairing a cell phone. This PIN can be changed.

➤ In the Bluetooth® menu, select the "PIN EDIT" menu item.

➤ Press the rotary control (7) to open the entry menu.

You can now enter the PIN:

➤ Turn the rotary control (7) to select a digit for the respective position.

➤ Press the rotary control (7) to go to the next position.

Note:

To return to the previous position in the entry menu, turn the rotary control (7) until the "<<<" option is selected, and press the rotary control (7).

Managing paired devices

In the Bluetooth® menu, you can manage the paired Bluetooth® devices (cell phones and streaming devices such as MP3 player).

In the device lists for cell phones and streaming devices, the Bluetooth® names or addresses of the paired devices are displayed. You can do the following:

- Disconnecting the connection to the currently connected Bluetooth® device
- Establishing a connection to one of the paired Bluetooth® devices
- Unpairing Bluetooth® devices

➤ In the Bluetooth® menu, select the menu item "PHONE LIST" or "STREAMING LIST".

➤ Press the rotary control (7) to open the menu. The first device on the list is displayed.

Note:

If no device is paired, "EMPTY LIST" is briefly displayed.

➤ Turn the rotary control (7) to select a different device or the "DELETE ALL" option.

You have the following options:

To connect the displayed device,

➤ press the  button (13).

As soon as the device is connected, "CONNECTED" is briefly displayed and you are returned to the Bluetooth® menu.

Note:

If no connection can be established, the display briefly shows "CONNECT FAILED". If the device is already connected, the display briefly shows "CONNECT EXIST".

To disconnect the connection to the displayed device,

➤ press the  button (12).

The display briefly shows "DISCONNECTED" and you are returned to the Bluetooth® menu.

Note:

If the device was not connected, the display briefly shows "NO CONNECTION".

To unpair the displayed device,

➤ press the  button (12) for approx. 2 seconds.

The display briefly shows "DELETED" and you are returned to the Bluetooth® menu.

Note:

If a telephone is unpaired, the numbers stored for this telephone and a phone book transferred from this cell phone are automatically deleted.

To unpair all the cell phones or streaming devices,

➤ select the "DELETE ALL" menu item.

➤ Press the rotary control (7).

The display shows "CONFIRM".

➤ Press the rotary control (7) or the  button (13) again.

The display briefly shows "EMPTY LIST".

Setting the button function for speed dial

You can select whether the long press of the  button (13) opens the phone book or activates voice dial.

➤ In the Bluetooth® menu, select the "SOFTKEY" menu item.

Next to "SOFTKEY", the current "P-BOOK" setting for phone book or "VOICE" for voice dial is displayed.

➤ Press the rotary control (7) to change the setting.

➤ Turn the rotary control (7) to change between the settings.

➤ Press the rotary control (7) to confirm the setting.

External audio sources

Front AUX-IN socket



Danger!

Increased risk of injury from connector.

In case of an accident, the protruding connector in the front AUX-IN socket may cause injuries. The use of straight plugs or adapters leads to an increased risk of injury.

For this reason, we recommend using angled jack plugs, e.g. the Blaupunkt accessories cable (7 607 001 535).

As soon as an external audio source, such as a portable MP3 player is connected to the front AUX-IN socket (11), it can be selected with the SRC button (16). "AUX" then appears on the display.

Notes:

- You can enter an individual name for the AUX source that is shown on the display in AUX mode (see the chapter "User settings", section "Making settings in the "VARIOUS" menu", menu item "AUX EDIT").
- You can play back an AUX source at the same time with one of the internal audio sources of the car sound system. Hence, you can play back the announcements of a navigation device connected to the front AUX-IN socket (11) via the loudspeakers of the car sound system while listening to the radio or a CD at the same time. In addition, you can adjust the volume levels of both audio sources to each other. For more details, please read the section "Making settings in the "VARIOUS" menu", menu items "AUX MIX" and "AUX MIX GAIN" in the chapter "User settings".

Sound settings

The following sound settings can be changed in the "AUDIO" menu:

- Adjusting bass and treble
- Setting the left/right volume distribution (Balance) or front/rear (Fader)
- Adjusting the increase of bass at low volume (Loudness)
- Selecting a sound profile (Sound Preset)
- Setting level and frequency of the preamplifier output (Sub-Out)
- Setting the 3-band equaliser
- Adjusting the time delay for switching in an external amplifier

Calling and exiting the "AUDIO" menu

- Briefly press the **MENU** button (2) to open the user menu.
- Turn the rotary control (7) until the "AUDIO" menu item is selected.
- Press the rotary control (7) to open the "AUDIO" menu.
- Turn the rotary control (7) until the desired menu item is selected.
- Perform the setting (see the next section).
- Briefly press the **MENU** button (2) to exit the menu.

Notes:

- The menu is automatically exited approx. 60 seconds after the last button activation and you are returned to the display of the current audio source.
- To go back to the next higher-level menu, turn the rotary control (7) until the "<<<" option is selected and press the rotary control (7).

Making settings in the "AUDIO" menu

BASS

Bass level. Settings: -7 to +7.

- Press the rotary control (7) to change the setting.
- Turn the rotary control (7) until the desired level is set.
- Press the rotary control (7) to confirm the setting.

TREBLE

Treble. Settings: -7 to +7.

- Press the rotary control (7) to change the setting.
- Turn the rotary control (7) until the desired level is set.
- Press the rotary control (7) to confirm the setting.

BALANCE

Left/right volume distribution. Settings: L9 (left) to R9 (right).

- Press the rotary control (7) to change the setting.
- Turn the rotary control (7) until the desired volume distribution is set.
- Press the rotary control (7) to confirm the setting.

FADER

Front/rear volume distribution. Settings: R9 (rear) to F9 (front).

- Press the rotary control (7) to change the setting.
- Turn the rotary control (7) until the desired volume distribution is set.
- Press the rotary control (7) to confirm the setting.

LOUDNESS

Increase of bass at low volume. Settings: ON, OFF.

- Press the rotary control (7) to change the setting.
- Turn the rotary control (7) to change between the settings.
- Press the rotary control (7) to confirm the setting.

PRESET EQ (sound profile)

Selecting equalizer presets. Settings: PRESET EQ POP, PRESET EQ ROCK, PRESET EQ CLAS (classical), PRESET EQ OFF (sound profile off; no presetting).

- Press the rotary control (7) to change the setting.
- Turn the rotary control (7) to change between the settings.
- Press the rotary control (7) to confirm the setting.

SUB-OUT

Setting the level and frequency of the preamplifier output.

- Press the rotary control (7) to open the menu.
- Turn the rotary control (7) to change between the following menu items:
 - FREQUENCY (settings: 80/120/160 Hz)
 - GAIN (settings: 0 to +7)
- Press the rotary control (7) to change the setting for the selected menu item.
- Turn the rotary control (7) to set the level or frequency.
- Press the rotary control (7) to confirm the setting.

AMP DELAY

Setting the delay with which a connect amplifier is switched in. Settings: 0.5/1.0/1.5/2.0/2.5 seconds and OFF (no delay).

- Press the rotary control (7) to change the setting.
- Turn the rotary control (7) until the desired delay is set.
- Press the rotary control (7) to confirm the setting.

Setting the 3-band equaliser

The radio features a 3-band equaliser. For each of the three treble, middle and bass bands, you can select a frequency as well as adjust the level. In addition, you can adjust the quality factor for bass and middle.

The equaliser also provides an adjustable increase of the bass at low volume (X-bass).

Opening the "EQUALIZER" menu

- In the "AUDIO" menu, select the "EQUALIZER" menu item.
- Press the rotary control (7) to open the menu.
- Turn the rotary control (7) to change between the following menu items:
 - EQUALIZER
 - EQ TREBLE
 - EQ MIDDLE
 - EQ BASS
 - EQ X-BASS

Note:

The submenus in the "EQUALIZER" menu are not automatically exited after the last key has been activated. After the setting, press the **MENU** button (2) to exit the menu.

EQUALIZER

Switching the equalizer on or off. Settings: ON, OFF.

- Press the rotary control (7) to change the setting.
- Turn the rotary control (7) to change between the settings.
- Press the rotary control (7) to confirm the setting.

EQ TREBLE

Adjusting treble frequency and level of the equalizer.

- Press the rotary control (7) to open the menu.
- Turn the rotary control (7) to change between the following menu items:
 - FREQUENCY
(settings: 10/12.5/15/17.5 kHz)
 - GAIN
(settings: -7 to +7)
- Press the rotary control (7) to change the setting for the selected menu item.
- Turn the rotary control (7) to set the level or frequency.
- Press the rotary control (7) to confirm the setting.

EQ MIDDLE

Adjusting centre frequency and level of the equalizer.

- Press the rotary control (7) to open the menu.
- Turn the rotary control (7) to change between the following menu items:
 - FREQUENCY
(settings: 0.5/1.0/1.5/2.5 kHz)
 - GAIN
(settings: -7 to +7)
 - Q-FACTOR
(settings: 0.5/0.75/1.0/1.25)
- Press the rotary control (7) to change the setting for the selected menu item.

- Turn the rotary control (7) to set the level, frequency or Q-factor.
- Press the rotary control (7) to confirm the setting.

EQ BASS

Adjusting bass frequency and level of the equalizer.

- Press the rotary control (7) to open the menu.
- Turn the rotary control (7) to change between the following menu items:
 - FREQUENCY (settings: 80/100/200 Hz)
 - GAIN (settings: -7 to +7)
 - Q-FACTOR (settings: 1.0/1.25/1.5/2.0)
- Press the rotary control (7) to change the setting for the selected menu item.
- Turn the rotary control (7) to set the level, frequency or Q-factor.
- Press the rotary control (7) to confirm the setting.

EQ X-BASS

Adjusting the frequency and level for the increase of bass at low volume.

- Press the rotary control (7) to open the menu.
- Turn the rotary control (7) to change between the following menu items:
 - FREQUENCY (settings: 60/80/100 Hz)
 - GAIN (settings: 0 to +3)
- Press the rotary control (7) to change the setting for the selected menu item.
- Turn the rotary control (7) to set the level or frequency.
- Press the rotary control (7) to confirm the setting.

User settings

Calling the user menu and selecting a menu

- Briefly press the **MENU** (2) button to open the user menu.

In the user menu, the user settings can be found in the following menus:

- TUNER
 - AUDIO (see chapter "Sound settings")
 - DISPLAY
 - VOLUME
 - CLOCK
 - VARIOUS
 - BLUETOOTH (Hamburg 420 BT only, see the chapter "Bluetooth®")
- Turn the rotary control (7) until the desired menu is selected.
 - Press the rotary control (7) to open the selected menu.
 - Turn the rotary control (7) until the desired menu item is selected.
 - Perform the setting (see the following sections).
 - Briefly press the **MENU** button (2) to exit the menu.

Notes:

- The menu is automatically exited approx. 60 seconds after the last button activation and you are returned to the display of the current audio source.
- To go back to the next higher-level menu, turn the rotary control (7) until the "<<<" option is selected and press the rotary control (7).

Making settings in the "TUNER" menu

TRAFFICINFO (traffic information) (only for reception area EUROPE)

Only possible in FM radio mode: Switching priority for traffic announcements on or off. Settings: ON, OFF.

- Press the rotary control (7) to change the setting.
- Turn the rotary control (7) to change between the settings.
- Press the rotary control (7) to confirm the setting.

If priority is switched on for traffic information, the display shows the icon .

BAND SELECTION

Activating or deactivating memory banks.

Memory banks that can be deactivated:

Region	Memory banks
EUROPE	FM2, FMT, MW, LW
USA	FM2, FMT, AM, AMT
SOUTH AMERICA	FM2, FMT, AM, AMT
THAILAND	FM2, FMT, AM, AMT

Settings in each case: ON, OFF.

- Press the rotary control (7) to open the menu.
- Turn the rotary control (7) until the desired memory bank is set.
- Press the rotary control (7) to change the setting.
- Turn the rotary control (7) to toggle between the settings ON (activate memory bank) and OFF (deactivate memory bank).
- Press the rotary control (7) to confirm the setting.

Deactivated memory banks are skipped during the source selection with the **SRC** button (16).

Notes:

- In the factory default, all AM memory banks are deactivated.
- If a memory bank is deactivated, the stations stored in this memory bank are retained.

REGIONAL (only for reception area EUROPE)

Only possible in FM radio mode: Switching REGIONAL function on or off. Settings: ON, OFF.

- Press the rotary control (7) to change the setting.
- Turn the rotary control (7) to change between the settings.
- Press the rotary control (7) to confirm the setting.

SENSITIVITY

Setting the sensitivity of station seek tuning. Settings: LO (-; low), HI (+; high).

- Press the rotary control (7) to change the setting.
- Turn the rotary control (7) to change between the settings.
- Press the rotary control (7) to confirm the setting.

RDS

Switching the RDS function on or off. Settings: ON, OFF.

- Press the rotary control (7) to change the setting.
- Turn the rotary control (7) to change between the settings.
- Press the rotary control (7) to confirm the setting.

Note:

If the reception area "USA", "SOUTH AMERICA" or "THAILAND" is selected, RDS is automatically switched off. The station name continues to be shown on the display.

PTY

Switching the PTY function on or off. Settings: ON, OFF.

- Press the rotary control (7) to change the setting.
- Turn the rotary control (7) to change between the settings.
- Press the rotary control (7) to confirm the setting.

PTY TYPES

Only possible with activated PTY function: Select a programme type.

Note:

As soon as a programme type has been selected, this programme type is shown as menu item in the menu instead of "PTY TYPES".

- Press the rotary control (7) to change the setting.
- Turn the rotary control (7) to change between the available programme types.
- Press the rotary control (7) to confirm the selected programme type.

PTY LANGUAGE

(only for reception area EUROPE)

Only possible with activated PTY function: Select a language for the display of the programme types. Settings: ENGLISH, DEUTSCH (German), FRANCAIS (French).

- Press the rotary control (7) to open the menu.
- Press the rotary control (7) to change between the languages.
- Turn the rotary control (7) to select a language.
- Press the rotary control (7) to confirm the selected language.

TUNER AREA (reception area)

Select the reception area for the radio reception. Settings: EUROPE, USA, SOUTH AMERICA, THAILAND.

- Press the rotary control (7) to open the menu.
- Turn the rotary control (7) to change between the reception areas.
- Press the rotary control (7) to select a reception area.
The display shows "PLEASE CONFIRM".
- Press the rotary control (7) to confirm the selected reception area.

Making settings in the "DISPLAY" menu

DIMMER

Select automatic or manual switching of the display brightness for day or night. Settings: AUTO (display brightness is automatically switched by switching the driving lights on or off), MANUAL (display brightness can be switched manually).

- Press the rotary control (7) to change the setting.
- Turn the rotary control (7) to change between the settings.
- Press the rotary control (7) to confirm the setting.

Automatic switching of the display brightness is possible only if your car sound system is installed as described in the installation instructions and your vehicle features the corresponding connection.

SCROLLING

Select the display of scrolling text (e.g. when displaying MP3 file names with more than 15 characters) either as single display or continued display. Settings: 1X (single display), ON (continued display).

- Press the rotary control (7) to change the setting.
- Turn the rotary control (7) to change between the settings.
- Press the rotary control (7) to confirm the setting.

LANGUAGE**(only for Hamburg 420 BT)**

Select the language for the display. Settings: ENGLISH, DEUTSCH (German).

- Press the rotary control (7) to change the setting.
- Turn the rotary control (7) to change between the settings.
- Press the rotary control (7) to confirm the setting.

Making settings in the "VOLUME" menu

ON VOLUME

Setting the power-on volume. Settings: ON VOLUME (power-on volume; 1 – 50) or LAST VOLUME (volume set last before switching off the car sound system).



Danger! **High volume**

The power-on volume can be unexpectedly high if the LAST VOLUME setting is selected and a high volume was set the last time the radio was switched off.

Always set the device to a moderate volume.

- Press the rotary control (7) to open the menu.
- Turn the rotary control (7) to switch between the menu items "LAST VOLUME" and "ON VOLUME" (power-on volume).

Upon selecting "LAST VOLUME":

- Press the rotary control (7) to confirm the setting.

Upon selecting "ON VOLUME":

- Press the rotary control (7) to change the setting.
- Turn the rotary control (7) to set the volume.
- Press the rotary control (7) to confirm the setting.

TRAFFIC VOL (traffic information volume) **(reception area EUROPE only)**

Setting the minimum volume for traffic announcements. Settings: 1 – 50.

- Press the rotary control (7) to change the setting.
- Turn the rotary control (7) to set the volume.
- Press the rotary control (7) to confirm the setting.

HANDSFREE VOL**(for Hamburg 420 BT only and with connected cell phone)**

Adjusting the level for handsfree volume. Settings: –5 to +5.

- Press the rotary control (7) to change the setting.
- Turn the rotary control (7) to set the level adjustment.
- Press the rotary control (7) to confirm the setting.

BEEP (button beep)

Switching the confirmation beep on or off. Settings: ON, OFF.

Note:

When storing radio stations, a confirmation beep sounds even if the OFF setting is selected.

- Press the rotary control (7) to change the setting.
- Turn the rotary control (7) to change between the settings.
- Press the rotary control (7) to confirm the setting.

Making settings in the "CLOCK" menu

PERM CLOCK

Switch the permanent display of the time on or off. Settings: ON, OFF.

- Press the rotary control (7) to change the setting.
- Turn the rotary control (7) to change between the settings.
- Press the rotary control (7) to confirm the setting.

If the permanent display of the time is switched on, the time is shown on the display. The display of the respective audio source is shown only after pressing a button. Approximately 15 seconds after the button is pressed last, the time is displayed again.

HOURLY MODE

Selecting the 12 or 24-hour time. Settings: 12, 24.

- Press the rotary control (7) to change the setting.
- Turn the rotary control (7) to change between the settings.
- Press the rotary control (7) to confirm the setting.

SET

Setting the time.

- Press the rotary control (7) to change the setting.
- Turn the rotary control (7) clockwise to set the hours.
- Turn the rotary control (7) counter-clockwise to set the minutes.
- Press the rotary control (7) to confirm the time set.

Note:

When you set the time in 12-hour mode (HOURLY MODE 12), an "AM" is displayed before the time for the time before noon or a "PM" for the time after noon.

Making settings in the "VARIOUS" menu

DEMO MODE

Switching the demo mode on or off. Settings: ON, OFF.

- Press the rotary control (7) to change the setting.
- Turn the rotary control (7) to change between the settings.
- Press the rotary control (7) to confirm the setting.

In demo mode, the features of the radio are shown as scrolling text on the display.

MIX AUX

Switching the combined playback of the AUX source with another audio source on or off. Settings: ON, OFF.

- Press the rotary control (7) to change the setting.
- Turn the rotary control (7) to change between the settings.
- Press the rotary control (7) to confirm the setting.

With the AUX MIX ON setting, an audio source connected to the front AUX-IN socket (11) is played back simultaneously with the respective active internal audio source of the car sound system (e.g. radio or CD).

AUX MIX GAIN (AUX MIX Level)

Adjusting the level of the AUX source with combined playback of the AUX source and another audio source (AUX MIX ON). Settings: -5 to +5.

- Press the rotary control (7) to change the setting.
- Turn the rotary control (7) to set the level adjustment.
- Press the rotary control (7) to confirm the setting.

This setting allows raising or lowering the level of the AUX source to adjust it to the level of the other active audio source.

AUX EDIT

Entry of an individual 15-digit name for the AUX source. Possible characters: space, 0 – 9, A – Z.

- Press the rotary control (7) to open the menu.
- Press the rotary control (7) to change the setting.

For each of the 15 characters:

- Turn the rotary control (7) to set the character.
- Press the rotary control (7) to confirm the setting.

You automatically change to the next character and finally return to the menu.

The name entered is shown on the display as soon as you select the AUX source.

SCAN TIME

Setting the scan time in seconds. Settings: 4/8/12/16/60 SEC.

- Press the rotary control (7) to change the setting.
- Turn the rotary control (7) to change between the settings.
- Press the rotary control (7) to confirm the setting.

VERSION

Displaying the version of the CPU and software of the radio.

- Press the rotary control (7) to open the menu.
- Turn the rotary control (7) to toggle between the display of the version number of CPU (P) and software (E).

NORMSET

Restoring the original factory settings of the car sound system.

- Press the rotary control (7).
The display shows "PLEASE CONFIRM".
- Press the rotary control (7) again to confirm the resetting.

The car sound system switches off and is reset to the factory settings. If a CD has been inserted in the CD drive, the car sound system automatically switches on again.

Factory settings

Important factory settings in the user menu:

Menu item	Factory setting
TUNER AREA	EUROPE
FM1 / FM2 / FMT	ON
MW* / LW*	OFF
AM** / AMT**	OFF
RDS	ON
REGIONAL*	OFF
TRAFFICINFO*	OFF
SENSITIVITY	HI
PTY	OFF
ON VOLUME	LAST VOLUME
TRAFFIC VOL*	20
BEEP	ON
SCAN TIME	8 SEC
DIMMER	MANUAL
HOURLY MODE	24
CLOCK SET	00:00

* Only in reception area "EUROPE"

** Only in reception areas "USA", "SOUTH AMERICA" and "THAILAND"

In the user menu, you can restore the original factory settings of the car sound system (see the chapter "User settings", section "Making settings in the "VARIOUS" menu", menu item "NORMSET").

Useful information

Warranty

We provide a manufacturer's warranty for products bought within the European Union. For devices purchased outside the European Union, the warranty terms issued by our respective responsible domestic agency are valid. The warranty terms can be called up from www.blaupunkt.com.

Service

In some countries, Blaupunkt offers a repair and pick-up service.

Information about the availability of this service in your country can be found at www.blaupunkt.com.

If you want to take advantage of this service, you may request a pick-up service for your car sound system via the Internet.

Technical data

Voltage supply

Operating voltage: 10.5 – 14.4 V

Current consumption

In operation: < 10 A

10 sec. after switch-off: < 3.5 mA

Amplifier

Output power: 4 x 22 watts sine at
14.4 V at 4 ohms.

4 x 50 watts max. power

Tuner

Wavebands in Europe/Thailand:

FM: 87.5 – 108 MHz

AM (MW): 531 – 1,602 kHz

LW (Europe only): 153 – 279 kHz

Wavebands in the US:

FM: 87.7 – 107.9 MHz

AM (MW): 530 – 1,710 kHz

Wavebands in South America:

FM: 87.5 – 107.9 MHz

AM (MW): 530 – 1,710 kHz

FM frequency response: 30 – 15,000 Hz

CD

Frequency range: 20 – 20,000 Hz

Pre-amp out

4 channels: 2 V

Input sensitivity

Front AUX-IN: 300 mV / 10 kΩ

Dimensions and weight

W x H x D: 178 x 50 x 160 mm

Weight: approx. 1.70 kg

Subject to changes

Installation instructions



Safety instructions

When carrying out installation work and making connections please observe the following safety instructions:

- Disconnect the negative terminal of the battery! When doing so, please observe the vehicle manufacturer's safety instructions.
- Make sure you do not damage vehicle components when drilling any holes.
- The cross sections of the positive and negative cables must not be less than 1.5 mm².
- **Do not connect the vehicle's plug connectors to the radio!**

You can obtain the adapter cable required for your vehicle type from any BLAUPUNKT dealer.

- Depending on the model, your vehicle may differ from the description provided here. We accept no responsibility for any damages due to incorrect installation or connection or for any consequential damages.

If the information provided here is not suitable for your specific installation requirements, please contact your Blaupunkt dealer, your vehicle manufacturer or our telephone hotline.

When installing an amplifier, you must first connect the device earth connections before connecting the plugs for the line-out jacks.

Earth connection of external devices may not be connected to earth of car sound system (housing).

Supplied mounting hardware

1 011 202 322 / 1 011 202 422:

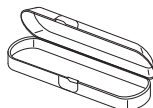
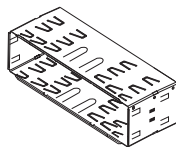

1 011 202 323 / 1 011 202 423:

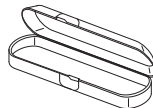
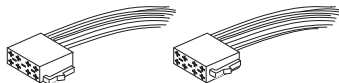
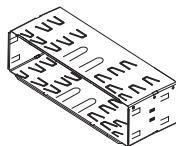

Available as an optional accessory

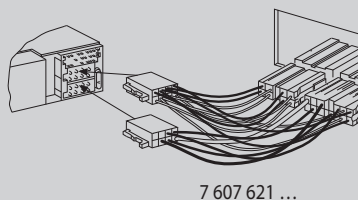

Installation kits

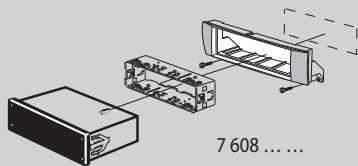

1.

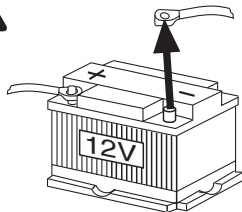

2.

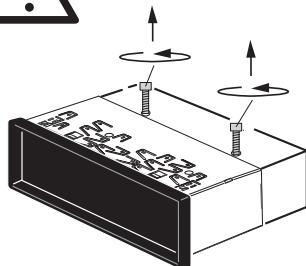

3.

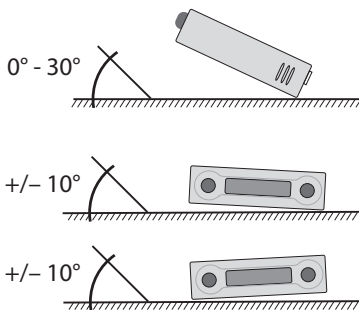

4.

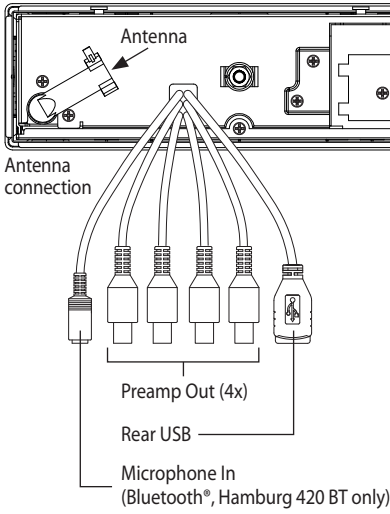

5.

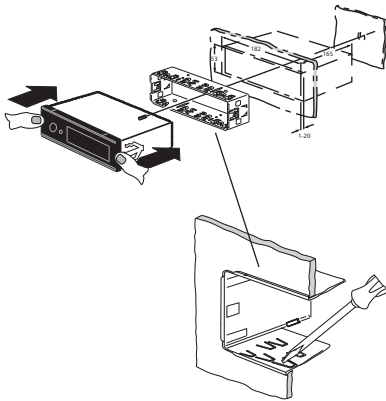

6. Removal

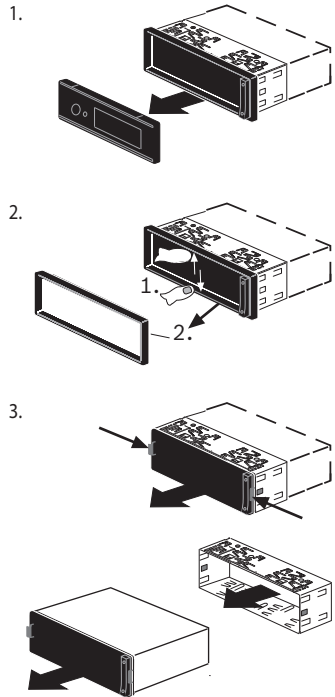

7.

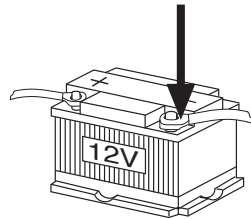

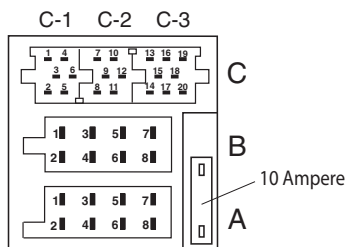

- * Aut. antenna / Amplifier +12V
 Remote Control +12V

max. 150 mA

A		B	
1	Sub Out GND	1	Speaker out RR+
2	Radio Mute	2	Speaker out RR-
3	Sub Out	3	Speaker out RF+
4	Permanent +12V	4	Speaker out RF-
5	Aut. antenna +12V *	5	Speaker out LF+
6	Illumination	6	Speaker out LF-
7	Kl.15/Ignition	7	Speaker out LR+
8	Ground	8	Speaker out LR-

C1		C2		C3	
1	NC	7	Telephone AF +	13	NC
2	NC	8	Telephone AF -	14	NC
3	NC	9	Radio Mute	15	NC
4	NC	10	Remote Control +12V *	16	NC
5	NC	11	Remote Control IN	17	NC
6	NC	12	Remote Control GND	18	NC
				19	NC
				20	NC

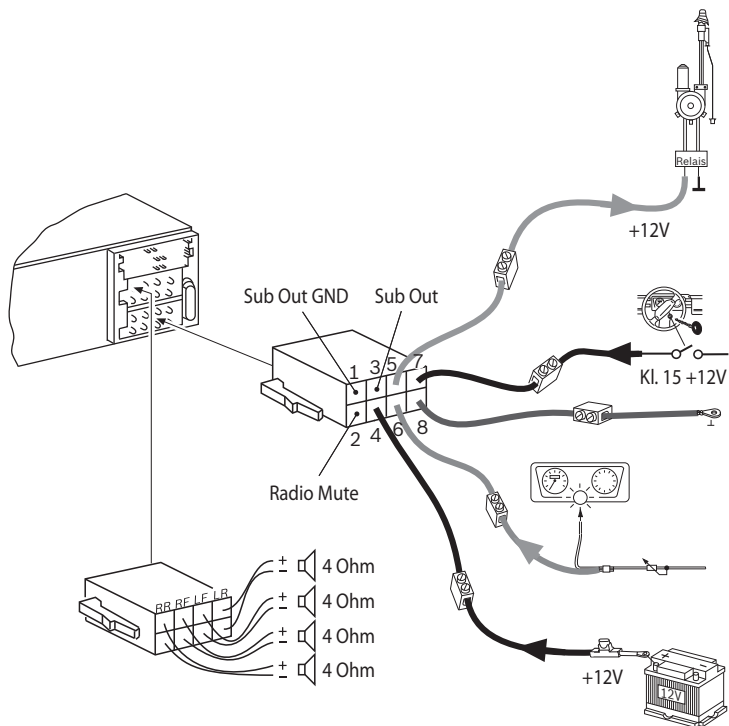

Supported iPod/ iPhone devices

Our product can support below listed iPod/ iPhone generations:

- iPod touch (4th generation)
- iPod touch (3rd generation)
- iPod touch (2nd generation)
- iPod touch (1st generation)
- iPod classic
- iPod with video
- iPod nano (6th generation)
- iPod nano (5th generation)
- iPod nano (4th generation)
- iPod nano (3rd generation)
- iPod nano (2nd generation)
- iPod nano (1st generation)
- iPod
- iPhone 4S
- iPhone 4
- iPhone 3GS
- iPhone 3G
- iPhone

"Made for iPod" and "Made for iPhone" mean that an electronic accessory has been designed to connect specifically to iPod, iPhone respectively, and has been certified by the developer to meet Apple performance standards.

Apple is not responsible for the operation of this device or its compliance with safety and regulatory standards.

Please note that the use of this accessory with iPod, iPhone may affect wireless performance.

iPhone, iPod are trademarks of Apple Inc., registered in the U.S. and other countries.

This product is protected by certain intellectual property rights of Microsoft. Use or distribution of such technology outside of this product is prohibited without a license from Microsoft.

Please keep the filled-in radio pass in a safe place!

Passport

Name:

Type: **1 011 202** _ _ _

Serial no.: **BP**

 **BLAUPUNKT**

Blaupunkt AudioVision GmbH & Co. KG
Robert-Bosch-Straße 200
D-31139 Hildesheim
<http://www.blaupunkt.com>