



**CTB & CTBR SERIES
ELECTRIC CONVECTION OVENS
REPLACEMENT PARTS LIST**



EFFECTIVE DECEMBER 3, 2007

THE BLODGETT CORPORATION

44 Lakeside Avenue, Burlington, Vermont 05401 USA

Telephone: (802) 860-3700 (800) 331-5842 Fax: (802) 860-3732

www.blodgett.com

Superseding All Previous Parts Lists.

The Company reserves the right to make substitution in the event that items specified are not available.

ERRORS: Descriptive and/or typographic errors are subject to correction.

www.blodgett.com

IMPORTANT: When ordering parts, please provide the model, voltage and serial number of the oven. The identification plate is located above the control panel under the ledge.

CTB/CTBR

CONTROLS FOR OVENS MANUFACTURED BEFORE 7/83

ELECTRICAL COMPONENTS

◆ Doors Are Not Returnable

Ref. No.	Part No.	Description
1	20350	Buzzer, Electric 240V
2	18868	Mode Selector Switch w/o Knob, 1 SP
	21068	Mode Selector Switch w/o Knob, 2 SP
3	16686	Knob, Mode Selector Switch
4	30465	Cool Down Switch, Rocker SPDT Matt Black
5	16037	Indicator Light, 250V, Red, Round
	16605	Fuse, 10 AMP (Before 6/88 and after 1/97)
6	20162	Fuse, 10 AMP (Between 6/88 and 01/20/97)
	20442	Fuse Holder (After 01/20/97)
7	20163	Fuse Holder (Between 6/88 and 01/20/97)
	16604	Fuse Holder (Before 6/88)
8	32313	Motor, 230V, 1 PH, 1/4 HP, 1 SP
8	32302	Motor, 230V, 1 PH, 1/4 HP, 2 SP
9	6138	Blower Wheel Assy., (8-1/2" Diameter)
10	11204	Terminal Block w/ Screws
	4888	Lug, Grounding
	34898	Cord Set Assy. w/receptacle, 3 PH
	34899	Cord Set Assy. w/receptacle, 1 PH
	37227	Harness, Element 5 KW
	16647	Harness, Element 7.5 KW
11	19118	Element Assy., 208V, 5 KW
11	8596	Element Assy., 230V, 5 KW
11	8595	Element Assy., 240V, 5 KW
	19284	Element Assy., 208V, 7.5 KW
	90097	Element Assy., 230V, 7.5 KW
	90098	Element Assy., 240V, 7.5 KW

NOTE: 2 Element Rings in element assy = 5 KW
3 Element Rings in element assy = 7.5 KW

12	6177	Microswitch Plate (used with 16880)
	16880	Microswitch Assy., Door (Before 02/14/97)
	33946	Microswitch Assy., Door (After 02/14/97)
	33286	Activator, Door Switch (Before 07/17/98) used with 33946
	34524	Activator, Door Switch (07/17/98 and After) used with 33946
13	21430	Axial Fan Kit, 3", 230V (Before 05/22/97 or S.N. 052297LA035S)
13	23034	Axial Fan Kit, 4", 230V (After 05/22/97 or S.N. 052297LA035S)
14	38559	Mechanical Contactor Conversion Kit, (1&3PH)
	R11087	Mechanical Contactor, 3 Pole, 40 AMP, 240V, (1& 3PH)

For KFC Only Use Below:
37296 Mercury Contactor, 3 Pole, 30 AMP, 208/240V, 3PH
18651 Mercury Contactor, 2 Pole, 60 Amp, 208V, 1PH

(All Contactors listed above for 5KW or 7.5KW Ovens)

Ref. No.	Part No.	Description
	5147	Timer, 60 Minute Mechanical w/ Knob
	16498	Knob, Timer 60 Minute Mechanical
	11304	Dial, 60 Minute Mechanical Timer
	16948	Timer, 60 Minute for Electric Buzzer w/ Knob
	16820	Dial Plate
	16030	Knob, 60 Minute Timer for Electric Buzzer
	5279	Thermostat, KX-38-36 w/o Knob (140° - 550°)
	11224	Dial, Thermostat
	6502	Cool Down Switch, Rocker DPDT, Red
	6500	Blower Switch, Rocker DPST, Blue
	6504	Indicator Light, 250V, Red, Rectangular
	5255	Fuse, 10 AMP
	11238	Fuse Holder
	8592	Control Panel Assy., CTB-1- NLA
	9637	Control Panel Assy., CTBR-1

CONTROLS FOR OVENS MANUFACTURED 7/83 THROUGH 9/86

Ref. No.	Part No.	Description
	15956	Timer, 60 Minute w/o Knob (Cook Only)
	16030	Knob, Timer
	16536	Thermostat, Cook KX-234-36 w/o Knob (140° - 500°)
	17212	Knob, Thermostat
	90588	Contact, 50 AMP
	16607	Control Decal, Lexan (Cook Only)

MISC. COMPONENTS

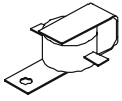

1
20350
Buzzer,
240V

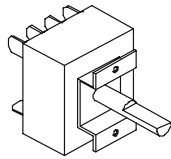

2
18868-3 pos.
21068-4 pos.
Mode Selector
Switch

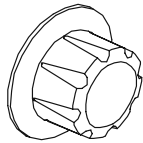

3
16686
Knob,
Black

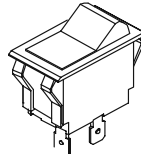

4
M5133
Cool Down Switch,
Rocker, Black

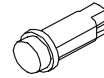

5
16037
Indicator
Light

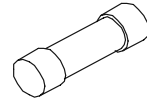

6
20162 or
16605
Fuse

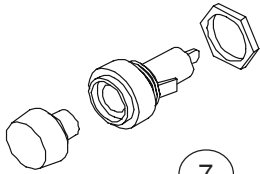

7
20163 or
20442
Fuseholder

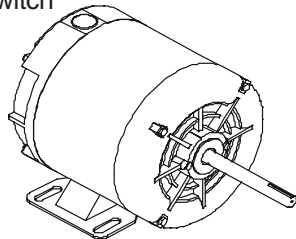

8
32313 or
32302
Motor

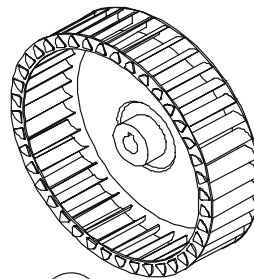

9
6138
Blower
Wheel

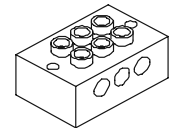

10
11204
Terminal
Block

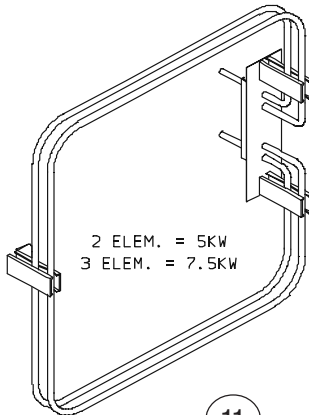

11
8596 - 230V 5KW
8595 - 240V 5KW
19284 - 208V 7.5KW
90097 - 230V 7.5KW
90098 - 240V 7.5KW
Element Assy

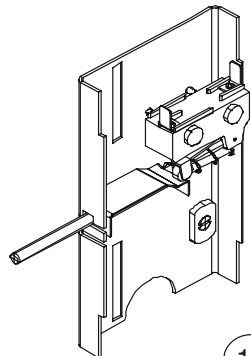

12
16880
Microswitch

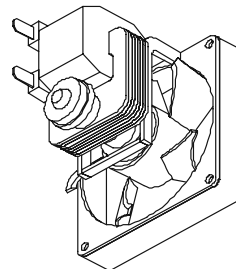

13
21430, 3"
or
23034, 4"
Axial Fan

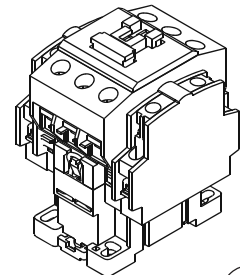

14
R11087
Contactor,
3 Pole,
40A

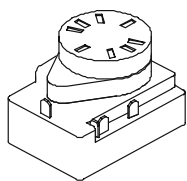

**
18226
Timer,
60 min, 240V
**See Page 4

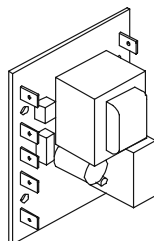

**
18578
Control
Board, S.S.
**See Page
4

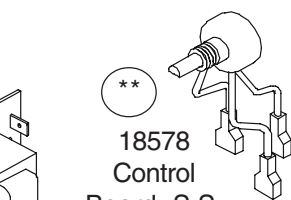

**
18234
Potentiometer
See Page 4



**
18588
Probe
**See Page 4

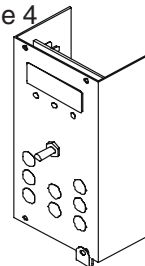

**
30658
Controller,
Solid State Digital
**See Page 6

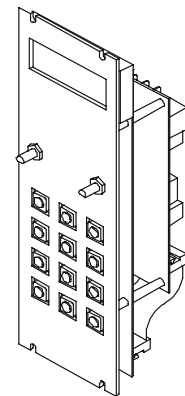

**
23390
Controller,
Intellihold
12 Key
**See Page 6

**SOLID STATE MANUAL CONTROLS
STANDARD ON OVENS MANUFACTURED AFTER 9/86**

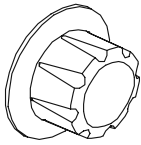

6
16686
Knob,
Black

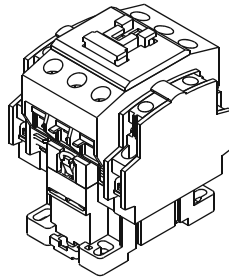

5
R11087
Contactor,
3 Pole
40A

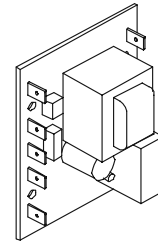

1
18578
Control
Board,
S.S.

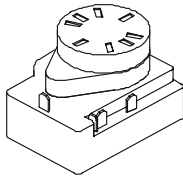

4
18226
Timer,
60 min, 240V

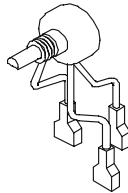

3
18234
Potentiometer

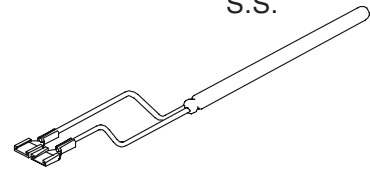

2
18588
Probe

Ref. No.	Part No.	Description
	20346	Temperature Controller, 3 Positions (Specify Model & Temperature Settings)
	21432	Temperature Controller, 1 Position (Specify Model & Temperature Settings)
	16645	Probe, Temperature (For 1 & 3 Position Controllers) (2 Wires)
	16542	Probe, Temperature (For 1 & 3 Position Controllers) (4 Wires)
	16536	Thermostat, KX-234-36, Back-Up
	16393	Knob, for back up Thermostat 16536
1	18578	Temperature Control Board, Solid State
2	18588	Probe, Temperature
3	18234	Potentiometer, Remote (Infinite Control)
	18577	8 Position Temperature Switch (Specify Model & Temperature Settings)
	16686	Knob, 8 Position Temperature Switch
4	18226	Timer, 60 Minute 240V
6	16686	Knob, Timer
	90099	Heat Selector Switch, 3 Positions w/o Knob (Used w/20346)
6	16686	Knob, Heat Selector Switch
5	38559	Mechanical Contactor Conversion Kit
	16685	Control Decal, Lexan (3 Position)
	22018	Control Decal, Lexan (Infinite Cook Only)
	18908	Control Decal, Lexan (8 Set Point Cook)
	16637	Control Decal, Wendy's only
	30465	Rocker Switch, DPDT (For 1 or 3 set pt. only)

SOLID STATE DIGITAL CONTROLS 5 KEY

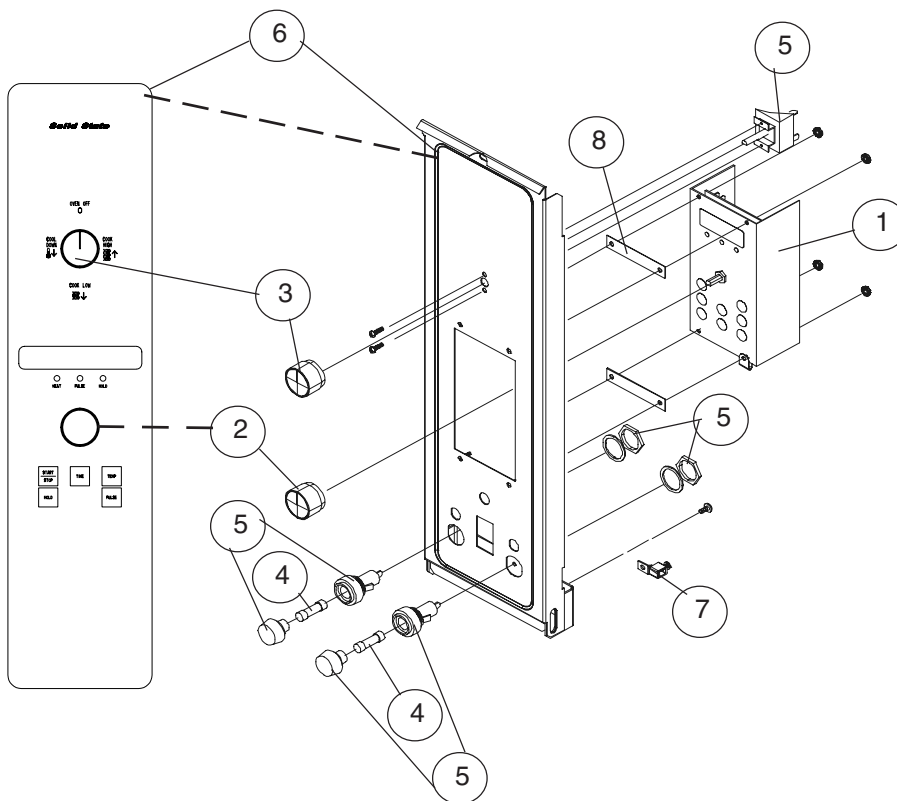

Ref. No.	Part No.	Description
1	30658	Controller, Time/Temp. (5 Key)
	FW529	Controller, Recond. Time/Temp(5 Key)
	21068	Mode Switch, 4 pos.
	18588	Probe, Temperature (see picture prior page, item 2 page 4)
2	24685	Knob, Adjust
3	24684	Knob, Mode
4	16605	Fuse, 10 AMP (Before 6/88 and after 01/20/97)
4	20162	Fuse, 10 AMP (Between 6/88 and 01/20/97)
5	20442	Fuse Holder (After 01/20/97)
5	20163	Fuse Holder (Between 6/88 and 01/20/97)
5	16604	Fuse Holder (Before 6/88)
	30662	Momentary Light Switch
	16880	Microswitch Assy., Door
	23086	Suppressor Assy.
6	30668	Control Panel & Decal Assy., 1 SP
6	30669	Control Panel & Decal Assy., 2 SP
7	90034	Grounding Lug
8	24931	Spacer, Control Qty 2

FAN DELAY WITH PULSE PLUS

<u>Ref. No.</u>	<u>Part No.</u>	<u>Description</u>
	18291	Timer, Fan Delay, 10 Minute, 240V
	18293	Timer, Fan On, 30 Minute, 240V
	18583	Timer, Solid State, Pulsing, 30 Second, 240V
	16539	Indicator Light, 250V, Amber
	18582	Relay, 3PDT, 240V w/ Bracket
	18910	Control Decal, Lexan (8 Set Point)
	18911	Control Decal, Lexan (Infinite)

COOK & HOLD CONTROLS

<u>Ref. No.</u>	<u>Part No.</u>	<u>Description</u>
	17982	Timer, 12 Hour w/ Knob (Before 3/7/85)
	17863	Timer, 12 Hour w/o Knob (After 3/7/85)
	16686	Knob, Timer
	15365	Thermostat, Hold K-877-36 w/o Knob (120° - 200°) (Before 9/86)
	16392	Knob, Hold Thermostat
	20351	Temperature Controller, Hold (150° - 250°) (After 9/86)
	16686	Knob, Hold Temperature Controller
	18588	Probe, Temperature
	18868	Mode Selector Switch w/o Knob (Before 9/86)
	20347	Mode Selector Switch w/o Knob (After 9/86)
	16686	Knob, Mode Selector Switch
	16539	Indicator Light, 250V, Amber, Round, Hold
	90268	Relay, 10 AMP, 3PDT
	17926	Microswitch Assy., Door Dbl (Before 9/86)
	16608	Control Decal, Lexan (C & H) (Before 9/86)
	18907	Control Decal, Lexan (Infinite Cook & Hold) (After 9/86)

INTELLITOUCH II CONTROL

33 KEY

<u>Ref. No.</u>	<u>Part No.</u>	<u>Description</u>
	24433	Controller, Intellitouch II
	30857	Probe, Temperature
	21169	Knob, Control
	5279	Thermostat, Back-Up KX-38-36
	19621	Switch, Back-Up Thermostat Rocker, DPDT, Black
	22738	Decal, Thermostat/Switch
	21675	Relay, SPDT, 240VAC
	19619	Switch, On/Off Controller Rocker, DPST, Black
	22962	Strip, Product
	16880	Microswitch Assy., Door

INTELLITOUCH CONTROLS

17 Key

<u>Ref. No.</u>	<u>Part No.</u>	<u>Description</u>
	NLA	Temperature Controller, Integrated (Specify Model & Temperature Settings)
<p>NOTE: <i>Intellitouch Controller is no longer available. Please see page 9 for IQ2 conversion kit information.</i></p>		
	33523	Casters, Adjustable (Set of 4)
	20360	Probe, Temperature Integrated
	20112	RFI Filter (Used w/ Integrated Controller)
	18979	Metal Oxide Varistor Assy.
	20356	Transformer, 230V to 24V
	17926	Microswitch Assy., Door Double, 1SP
	20167	Control Panel & Decal Assy., (Before 10/87)
	19189	Control Panel & Decal Assy., (After 10/87)

INTELLIPLUS & INTELLIHOLD CONTROLS

12 KEY & 13 KEY

<u>Ref. No.</u>	<u>Part No.</u>	<u>Description</u>
	NLA	Controller, Intelliplus (13 Key)
**	NLA	Controller, Intellihold (12 Key) pictured p.3
<p>NOTE: <i>Intelliplus/hold Controllers are no longer available. Please see page 9 for IQ2 conversion kit information.</i></p>		
	23392	Probe, Temperature
	21443	Knob, Control
	23086	Suppressor Assy.
	20683	Wiring Harness, Control Panel
	24932	Control Panel & Decal Assy., Intelliplus
	24933	Control Panel & Decal Assy., Intellihold
	33472	Door Switch, 2 speed
	23086	Suppressor Assy.
	24503	Wiring Harness, Control Panel
	34354	Control Panel & Decal Assy. Intellitouch II

CH102 CONTROLS 14 KEY

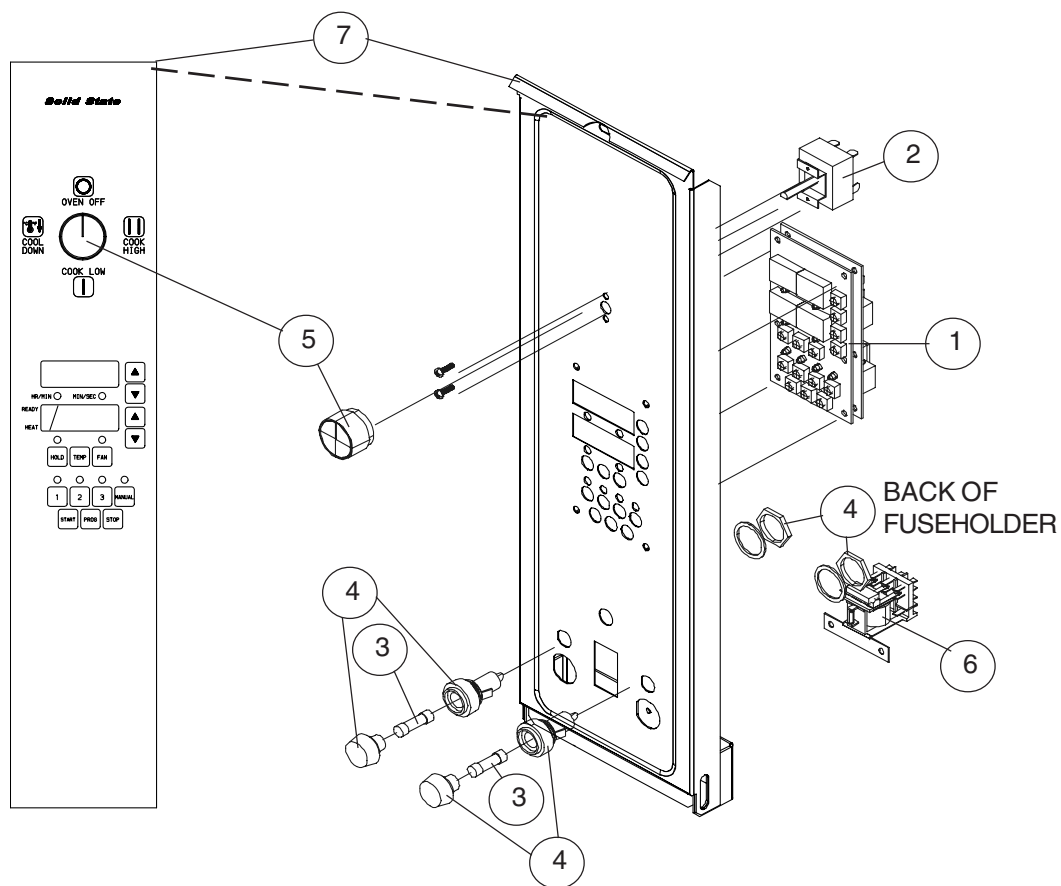

Ref. No.	Part No.	Description
1	37087	Controller, CH102 14 Key
	34473	Probe, RTD 36"
2	21068	Mode Selector Switch, 4 Position
	19620	Light Switch, Rocker, DPST, Momentary
3	16605	Fuse, 10 Amp Qty 2
4	20442	Fuseholder, 30 Amp Qty2
5	24685	Knob, Adjust for Mode Selector Switch Qty 1
	23086	Suppressor Assy
6	21675	Relay, SPDT 240V Qty 1
	16563	Relay Bracket
	21058	Harness, Wiring Control Compartment
	34411	Harness, Wiring 2 SP
7	36290	Control Panel & Decal Assy, CH102

**EXCLUSIVE TO KFC IQ CONTROLS
1997 AND AFTER OR CTB-AP (All Purpose)**

<u>Ref. No.</u>	<u>Part No.</u>	<u>Description</u>	<u>Ref. No.</u>	<u>Part No.</u>	<u>Description</u>
1	34968	Control, "IQ" w/"SCK" for U.S.		35973	Liner, Baffle Assy.
1	FW531	Control, "IQ" w/"SCK" for U.S., Recon.		34935	Baffle Bracket Kit
	34450	Motor, 230V, 2SP (for IQ Cntrl.)		34875	Removeable Access Panel, Bodyside
	33902	Relay		34454	Door Assy, RH Grease Seam
	33073	Relay Board		34449	O-Ring (seals lower door bushings)
	33074	Probe, RTD 1000 Ohm		34947	Perimeter Door Gasket Assy(After 4/29/99)
	33088	Probe Clip		34451	RTV, Red (caulking used with door gasket)
	33922	Socket, Relay		33241	Decal, On/Off, Reconditioned
	M6899	Transformer	7	32999	Control Retainer
2	16605	Fuse, 10 AMP	8	33169	Gasket Retainer
3	20442	Fuseholder, 30 AMP. Class CC	9	33151	Gasket, Control Back
4	33240	Fuse Decal	10	37296	Contactora, Mercury, 3 Pole, 30 Amp,208/240V
	33072	Control Harness 24V		18651	Contactora, Mercury, 2 Pole, 60 Amp, 208V, 1 PH
	34435	Harness, IQ Cntrl.		34430	Top cap
	34436	Harness, IQ Cntrl., Rear			
	34951	Harness, SCK "Communication"			
	33904	MOV Assy.			
5	19619	Rocker, DPST, Black (Power Switch)			
	34284	Grease Shield			
	34041	US Product Strip (for IQ Controls)			
	33527	Product Strip CAN			
	33155	Front Communication Port			
	34453	Rack Support (Qty 1)			

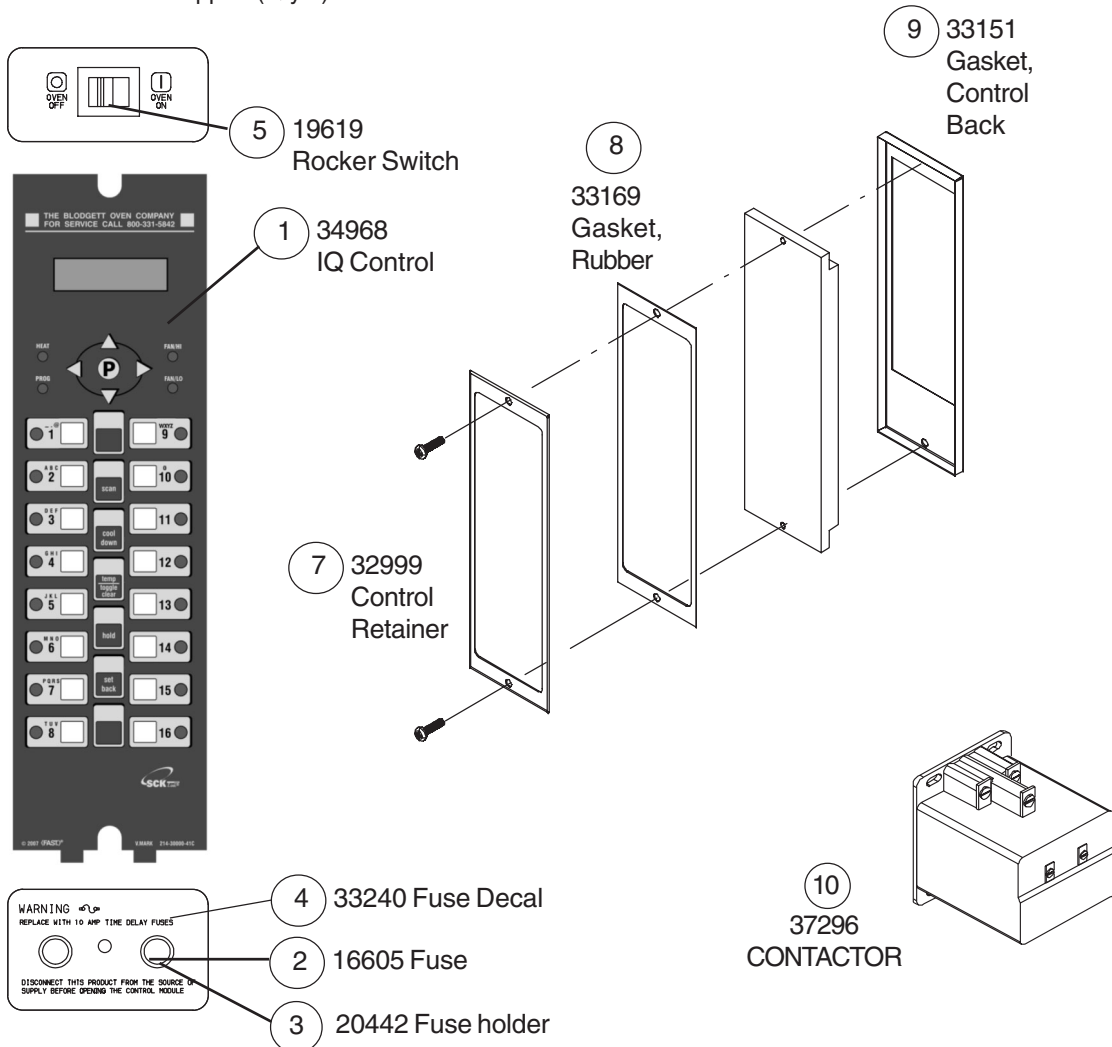

IQ2 CONTROLS

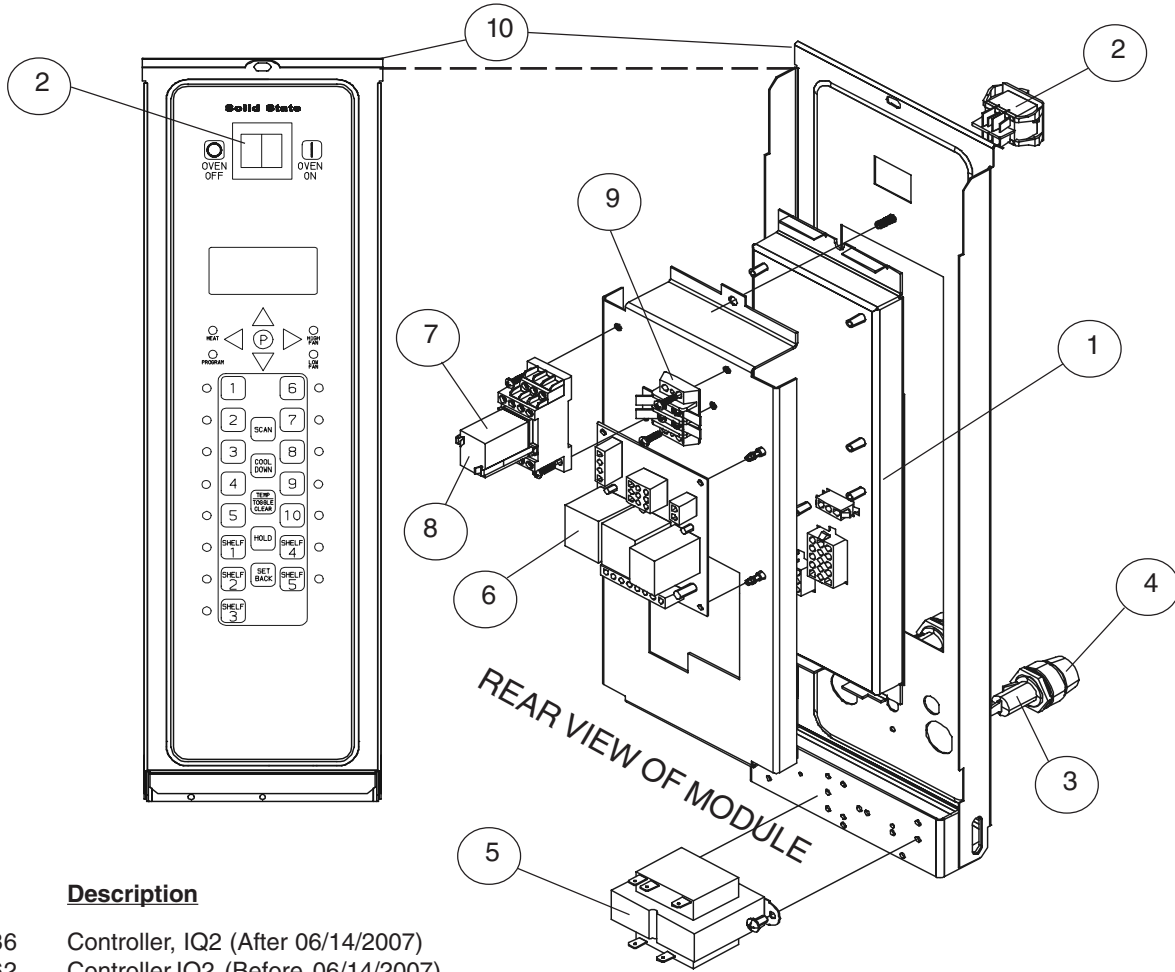

Ref. No.	Part No.	Description
1	50736	Controller, IQ2 (After 06/14/2007)
1	51062	Controller, IQ2 (Before 06/14/2007) NOTE: for ovens prior to 06/14/2007 51062 includes new panel & decal
	36995	Controller, IQ2 Burger King only
	33074	Probe, RTD
2	19619	Switch, Rocker, DPST
3	16605	Fuse
4	20442	Fuseholder
5	M6899	Transformer
6	33073	Relay Board
7	33902	Relay, Logic
8	33922	Socket, Relay
	33072	Harness, Control 24V
	34435	Harness, Controller IQ2
9	M0593	Terminal Block
10	37707	Panel & Decal Assy (After 06/14/2007)
	51061	Panel & Decal Assy (Before 06/14/2007)
	32999	Control Retainer
	33169	Gasket, Rubber
	33151	Gasket, w/Control Back
	36729	IQ2 Conversion Kit (From Intellitouch) 1SP 1 PH 5 KW
	36724	IQ2 Conversion Kit (From Intellitouch) 1SP 1 PH 7.5 KW
	36727	IQ2 Conversion Kit (From Intellitouch, Intellihold or Intelliplus) 2SP 1 or 3 PH 5 & 7.5 KW

Ref. No.	Part No.	Description
	37076	IQ2 Conversion Kit (From Intellitouch, Burger King Only) 1SP 1 PH 5 KW
	37077	IQ2 Conversion Kit (From Intellitouch, Burger King Only) 1SP 1PH 7.5 KW
	37036	IQ2 Conversion Kit (From Intellitouch, Burger King Only) 2SP 1 or 3 PH 5 & 7.5 KW

NOTE: Conversion Kits above include all components to convert your unit. You may order parts separately after conversion is completed.

COMPUTER READY OVENS
FASTRON DIGITAL TIMER-KFC

<u>Ref. No.</u>	<u>Part No.</u>	<u>Description</u>
	16542	Probe, Temperature (Dual 4 Wire) for 3 Position & 1 Position Boards
	16645	Probe, Temperature (2 Wires) for 8 Set Point and Infinite Boards
	17925	Cable Extension (For Single Oven)
	18273	Wire Assy., Extension (For Double Oven)
	22929	Control Decal, KFC Only (Pos. w/o timer)
	37296	Contactora, Mercury, 3 Pole,30AMP,208/240V (5 or 7.5KW) 3 PH
	18651	Contactora, Mercury, 2 Pole, 60 AMP,208V (5 or 7.5 KW) 1 PH

NOTE: The Fastron Digital Timer on the side or top of your oven is not supplied or serviced by Blodgett. If you have issues with this, please contact Fast.

BAKING COMPARTMENT COMPONENTS

<u>Ref. No.</u>	<u>Part No.</u>	<u>Description</u>
	22637	Rack, w/ball stops, Each, 20-7/8" x 14-5/8"
	8590	Rack Support, Set of 2 (Before 8/91)
	31311	Rack Support, Set of 2 (After 8/91)
	20353	Thermostat Bulb Clip (Each)
	6056	Interior Baffle (Blower Wheel Cover) CTB S/S
	35972	Interior Baffle (Blower Wheel Cover) CTB Porc. Replaces 10369
	9543	Interior Baffle (Blower Wheel Cover) CTBR S/S
	35973	Interior Baffle(Blower Wheel Cover) CTBR Porc. Replaces 10381
	20799	Baffle Support Assy. w/ Screws
	35934	Baffle Bracket
	9704	Screen Assy, Baffle

stands, Legs

<u>Ref. No.</u>	<u>Part No.</u>	<u>Description</u>
	11993	Stand, 5-3/4" Stainless
	10857	Stand, 7" Stainless
	18479	Stand, 16" Stainless w/ Shelf
	10856	Stand, 19" Stainless w/ Shelf
	10855	Stand, 24" Stainless w/ Shelf
	10854	Stand, 33" Stainless w/ Shelf
	34024	Stand, 11" Stainless w/Shelf & Adjustable Casters (KFC Only)
	34025	Stand, 19" Stainless w/Shelf & Adjustable Casters (KFC Only)
	18482	Stand, 16" Stainless w/ Shelf & Casters
	11437	Stand, 19" Stainless w/ Shelf & Casters
	15151	Stand, 24" Stainless w/ Shelf & Casters
	33940	Stand, 28" No Shelf (Burger King Only)
	15153	Stand, 33" Stainless w/ Shelf & Casters
	30028	Stand, 33" Stainless w/Feet and Rack
	20435	Legs, 4" w/ Bolts,S/S (Set of 4)
	20497	Shelf for Stand, S/S w/hardware
	16002	Casters (Set of 4)
	33523	Casters, Adjustable (Set of 4)
	33940	Stand, 28 ", (Burger King Only)

DOOR COMPONENTS

<u>Ref. No.</u>	<u>Part No.</u>	<u>Description</u>
<u>MANUFACTURED AFTER 9/86</u>		
◆	19607	Door Assy., Glass CTB
◆	19609	Door Assy., Glass CTBR
◆	19608	Door Assy., Solid CTB
◆	19610	Door Assy., Solid CTBR

NOTE: ALL DOORS FOR OVENS MANUFACTURED BEFORE 9/86 DO NOT INCLUDE PART # 17865 (ROLLER LATCH W/ SCREWS), PLEASE ORDER THIS PART SEPARATELY.

MANUFACTURED BETWEEN 1/85 & 9/86

◆	17947	Door Assy., Glass CTB
◆	17949	Door Assy., Glass CTBR
◆	17948	Door Assy., Solid CTB
◆	17950	Door Assy., Solid CTBR

NOTE: ALL DOORS FOR OVENS MANUFACTURED BEFORE 9/86 DO NOT INCLUDE PART # 17865 (ROLLER LATCH W/ SCREWS), PLEASE ORDER THIS PART SEPARATELY.

MANUFACTURED BEFORE 1/85

◆	17807	Door Assy., Roller Latch Conv. Glass CTB
◆	17810	Door Assy., Roller Latch Conv. Glass CTBR
◆	17808	Door Assy., Roller Latch Conv. Solid CTB
◆	17809	Door Assy., Roller Latch Conv. Solid CTBR

8589	Handle, Door 13"
19260	Gasket, Door Perimeter CTB (Manufactured After 9/86)
20735	Gasket, Door Perimeter CTBR (Manufactured After 9/86)
17862	Gasket, Door Perimeter (Manufactured Between 1/85 & 9/86)
11495	Gasket, Door Perimeter (Manufactured Before 1/85)
9036	Window Assy., Door (17-1/8" x 10")
9035	Window Tool (comes with window)
16880	Microswitch Assy., Door (Manufactured Before 2/14/97)
33946	Microswitch Assy., Door (Manufactured After 2/14/97)
33286	Door Pin Activator (Between 2/14/97 & 7/17/98)
34524	Door Pin Activator (7/17/98 and after)
17946	Door Roller Assy. CTB & CTBR (on Door) (Manufactured After 9/86)
17944	Door Roller Assy. CTB (on Door) (Manufactured Before 9/86)
17945	Door Roller Assy. CTBR (on Door) (Manufactured Before 9/86)
17865	Latch, Roller w/ Screws (on Oven) Used with 17946, 17944, 17945
90087	Door Catch, Spring Clip (Manufactured Before 1/85)
8583	Door Catch, Striker Plate (Manufactured Before 7/83)
8584	Door Catch, Ball Plunger w/ Nut (Manufactured Before 7/83)

DOOR COMPONENTS-CONT'D.

<u>Ref. No.</u>	<u>Part No.</u>	<u>Description</u>
5742		Spanner Key, Door Catch (Manufactured Before 7/83)
8594		Hinge Pin w/ Bolts
90017		Washers, Door, Set of 2 (Manufactured After 9/86)
90004		Bushings, Door Hinge, Set of 2 (Manufactured After 9/86)
912		Bushing, Welded, Qty. 1 (Manufactured Before 9/86)
11695		Washers, Door, Set of 12 (Manufactured Before 7/83)

EXTERIOR COMPONENTS

<u>Ref. No.</u>	<u>Part No.</u>	<u>Description</u>
6433		Crown Assy.
90086		Nameplate, Blodgett
8585		Steam Vent Box w/ Screws for CTB-1
90092		Steam Vent Riser w/ Screws for CTB-2 S/S
18699		Access Panel, S/S (Removeable Bodyside) (All units Before 07/01/98)
34875		Access Panel, S/S (Removeable Bodyside) CTB-AP (07/01/98 and after)
34876		Access Panel, S/S (Removeable Bodyside) CTB (07/01/98 and after)
34877		Access Panel, S/S (Removeable Bodyside) CTBR (07/01/98 and after)
16002		Casters (Set of 4)
33523		Casters, Adjustable (Set of 4)
18065		Bolts, Connecting CTB-2, Set of 2
6421		Body Top, S/S CTB & CTBR
23066		Body Top, S/S CTB & CTBR (Computer Ready only)

EXCLUSIVE TO KFC CE

EXCLUSIVE TO EXPORT

CTB-AP (All Purpose)			Ref. No.	Part No.	Description
Ref. No.	Part No.	Description			
26	34968	Control, "IQ" w/'SCK' CE		24417	Controller, Intelliplus 50 HZ 13 Key
	FW531	Control, "IQ" w/'SCK', Recon. CE		24413	Controller, Intellihold 50 HZ 12 Key
	34450	Motor, 230V, 2SP (for IQ Cntrl) CE		20084	Timer, 60 Minute, 240V, 50 HZ
	90097	Element Assy, 230V 5KW CE		20427	Timer, 12 Hour, 240V, 50 HZ
	8596	Element Assy, 230V, 7.5KW CE		18582	Relay, 3PDT, 240V
	36066	Thermostat, High Limit Kit (Manual Reset) CE Replaces M3295		33095	Block, Terminal, 6 Pole CE
	M0593	Terminal Block CE		37297	Contact, Mercury CE, Export
	M3167	Fuseholder, Type HTB-36M CE (for M8593)		36066	Thermostat, High Limit Kit (Manual Reset) CE Replaces M3295
	M8593	Fuse, Export 10 Amp CE		M3167	Fuseholder, Type HTB-36M CE (for M8593)
	M8662	Fuseblock, 5mm x 20mm CE (for M6899)		M8593	Fuse, Export 10 Amp CE
	M6899	Transformer, 208/240V-24V CE		8596	Element Assy, 230V 5 KW, 2 Ring Element
	19619	Rocker Switch, Black DPST CE		90097	Element Assy, 230V 7.5 KW, 3 Ring Element
	33072	Control Harness, 24V CE		8595	Element Assy, 240V, 5KW, 2 Ring Element (Great Britain only)
	33073	Relay Board CE		90098	Element Assy, 240V, 7.5KW, 3 Ring Element (Great Britain)
	33904	MOV Assy CE		M3810	Tube Clamp 1/8" CE
	33155	Front Communication Port CE		24684	Knob, Control Infinite CE
	33156	Rear Communication Port CE			
	33239	Control Panel Assy CE			
	33241	Decal, On/Off CE			
	33902	Relay CE			
	33922	Socket, Relay CE			
	33923	Clip, Relay CE			
	34435	Harness, IQ Cntrl. CE			
	35703	Fuse, 250V 1.0 AMP CE			
	35704	Fuse Label 1.0 AMP CE			
	35750	Decal, Fuse CE			
	34284	Grease Shield			
	34453	Rack Support (Qty 2)			
	35973	Liner, Baffle Assy.			
	34935	Baffle Bracket Kit			
	34875	Removeable Access Panel, Bodyside			
	34454	Door Assy, RH Grease Seam			
	34449	O-Ring Gasket (seals lower door bushings)			
	34947	Perimeter Door Gasket Assy (After 4/29/99 or S.N. 042999MA019S)			
	34451	RTV, Red (caulking used with door gasket)			
24	32999	Control Retainer			
25	33169	Gasket Retainer			
28	33151	Gasket, Control Back			