

Pager and Charger Guide
Part Number 321045B5

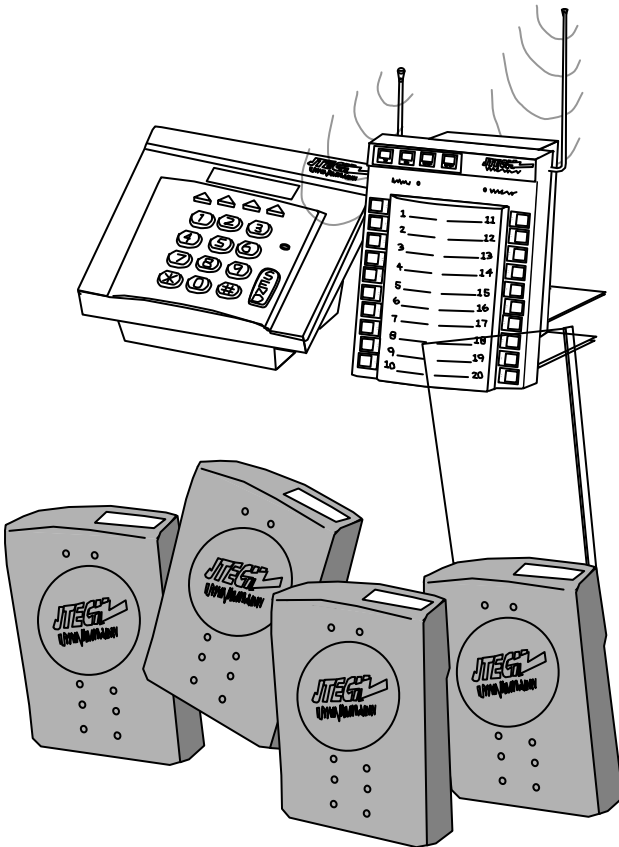

Premises Pager System[®]

QuikCall[™] Pagers



Introduction:

Congratulations on your purchase of a JTECH Paging System. Please take a few minutes to review this manual prior to installing and operating your system.

Please inspect the System upon receipt. If the contents appear to be damaged, notify the shipper immediately to file a claim and notify JTECH Customer Care. If any component is missing, please contact JTECH Customer Care.

If you have any questions or need assistance, please call JTECH Customer Care at 800-321-6221 or 561-997-0772, option 6.

Pager Certifications:**FCC statement:**

This device complies with Part 15 of the FCC Rules. Operation is subject to the following two conditions: (1) this device may not cause harmful interference, and (2) this device must accept any interference received, including interference that may cause undesired operation.

FCC Caution:

Changes or modifications not expressly approved by the part responsible for compliance could void the user's authority to operate the equipment.

RSS-Gen & RSS-210 statement:

This device complies with Industry Canada licence-exempt RSS standard(s). Operation is subject to the following two conditions: (1) this device may not cause interference, and (2) this device must accept any interference, including interference that may cause undesired operation of the device. Le présent appareil est conforme aux CNR d'Industrie Canada applicables aux appareils radio exempts de licence. L'exploitation est autorisée aux deux conditions suivantes : (1) l'appareil ne doit pas produire de brouillage, et (2) l'utilisateur de l'appareil doit accepter tout brouillage radioélectrique subi, même si le brouillage est susceptible d'en compromettre le fonctionnement.

RSS-102 Statement:

"This equipment complies with Industry Canada radiation exposure limits set forth for an uncontrolled environment. "

"Cet équipement est conforme à l'exposition aux rayonnements Industry Canada limites établies pour un environnement non contrôlé.

Pager Dimensions and Weights:**Pager (Without Clip)**

- LxWxH 1.0x 2.2x 3.1" (33x56x79mm)
- Weight 2.2oz (63gm)

Pager (With Metal Clip)

- LxWxH 1.4x 2.2x 3.1" (35x56x79mm)
- Weight 2.8oz (80gm)

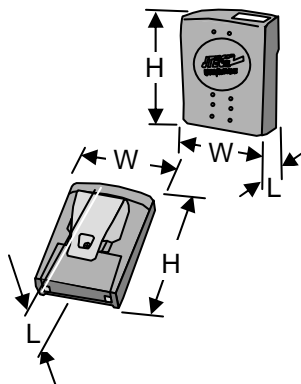

Pager (With Spring Clip):

- LxWxH 1.4x 2.2x 3.8" (35x56x97mm)
- Weight 2.6oz (74gm)

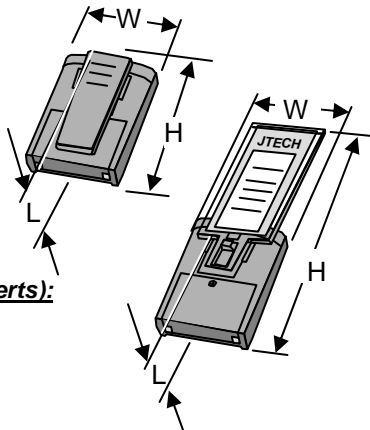

Pager (With Promotional Paddle And Inserts):

- LxWxH 1.2x 2.2x 7.7" (31x56x196mm)
- Weight 4.4oz. (124gm)

Charger Dimensions and Weight

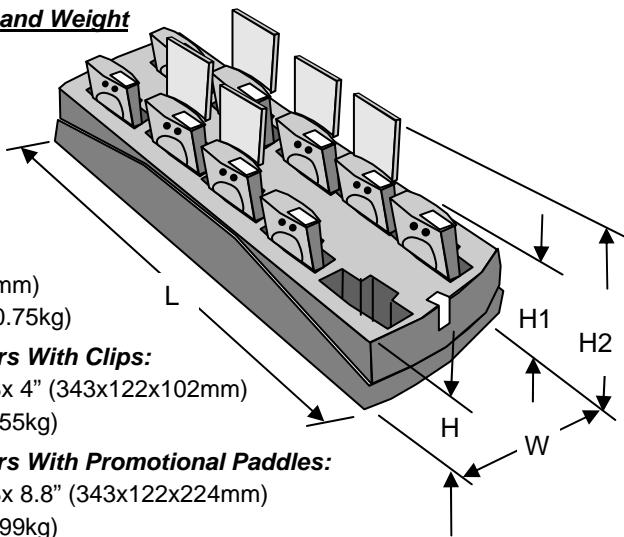

Charger Only

- LxWxH 13.5x 4.8x 2.6" (343x122x65mm)
- Weight 1.64lbs (0.75kg)

Charger and 10 Pagers With Clips:

- LxWxH1 13.5x 4.8x 4" (343x122x102mm)
- Weight 3.41lbs (1.55kg)

Charger and 10 Pagers With Promotional Paddles:

- LxWxH2 13.5x 4.8x 8.8" (343x122x224mm)
- Weight 4.38lbs (1.99kg)

Charger Components:

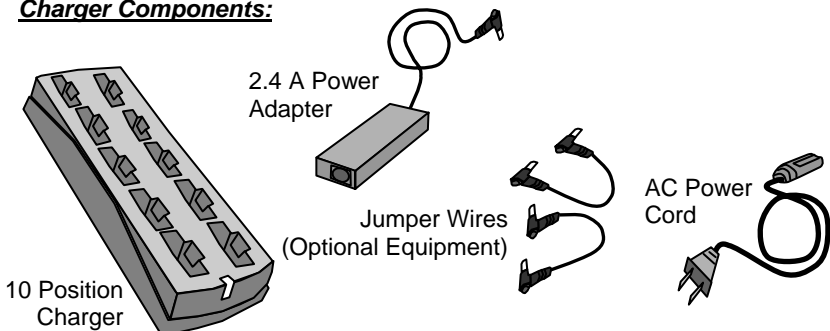

Define what transmitter is to be used. Note:

Charger Components

Connecting Power:

1. Insert the *Power Adapter* plug into jack on the bottom of the *Charger*.
2. Feed the wires through the guides in the bottom of the *Charger*.

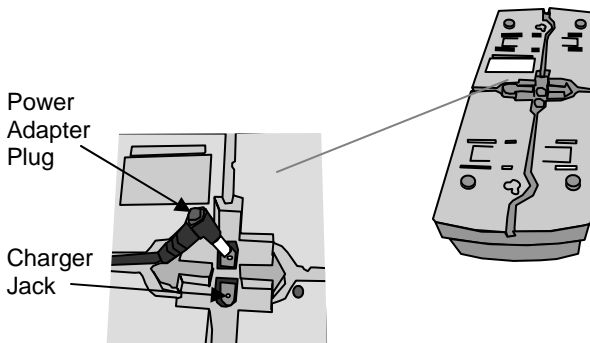

3. Connect the *Power Adapter* to the *AC Power Cord*.

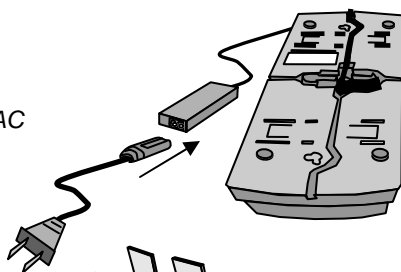

4. Plug the *AC Power Cord* into a 110-240VAC outlet.
5. The green LED on the *Charger* will light (ON).
6. Once the *Charger* is powered (ON), the *Pagers* can be inserted.

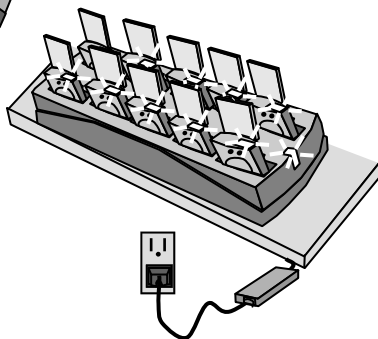
**Mounting Chargers:**

- *Chargers* can be wall, shelf or counter top mounted.
- Mounting hardware is user supplied.

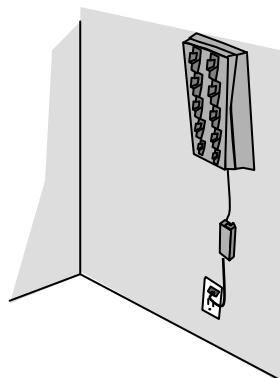

Combining Chargers:

If two *Chargers* are to be used, they can be combined with one *2.4A Power Supply*.

To combine:

1. Use a screwdriver or similar tool to extend the metal tabs out from one of the *Chargers*.
2. Place both *Chargers* on a table and slide together. The metal tabs will lock both *Chargers* together.

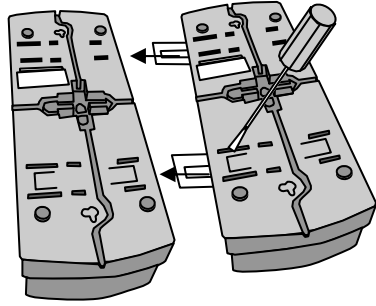

3. Insert the *Power Adapter* plug into jack on the bottom of the *Charger*.

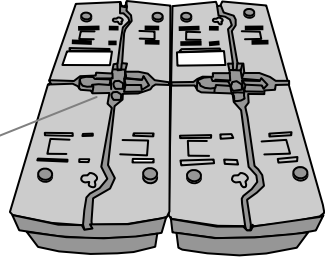
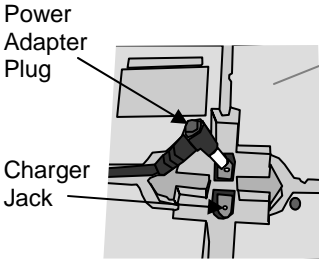

4. Use the *Jumper Wire* (optional) to connect both *Chargers* together.
5. Feed the wires through the guides in the bottom of the *Charger*.
6. Connect the *Power Adapter* to the *AC Power Cord*.

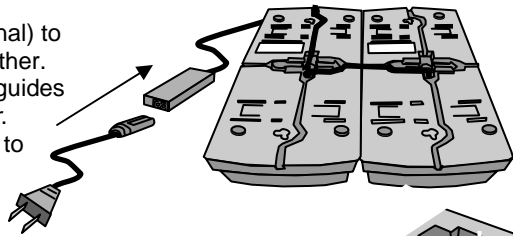

7. Plug the *AC Power Cord* into a 110-240AC outlet.
8. The green LED on the *Charger* will light (ON).

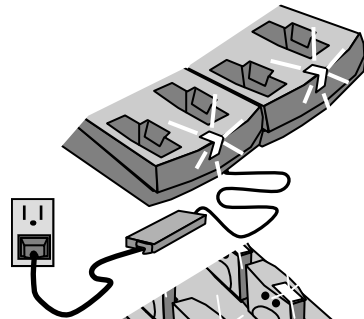

9. Once the *Charger* is powered (ON), the *Pagers* can be inserted.

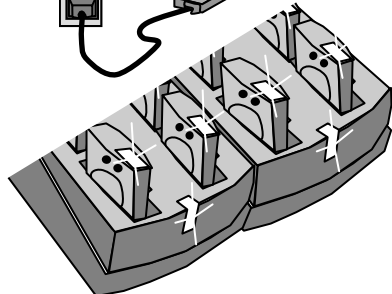

Charging Pagers:

- *Pagers* are turned OFF during shipment from JTECH.
- When first received, *Pagers* must be charged for a minimum of 3 hours prior to use. This first charge will also turn ON the *Pagers* for use.
- The charging system is two stage, with a fast initial and then final maintenance charge.

- **Charging *Pagers*:**

1. Insert *Pagers* into the empty locations of a powered (ON) *Charger*.

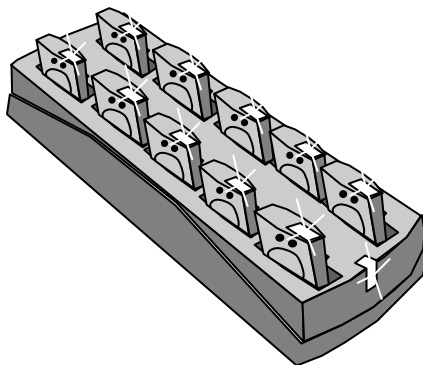

2. Each *Pager's* LED will light.
3. The LED color indicates charging condition.
 - ▶ Flashing yellow light = Battery charge very low. Charge needed. Do not use the *Pager*.
 - ▶ Solid yellow light = Charge needed.
 - ▶ Solid green light = OK to use.
4. *Pagers* in use and returned to the *Charger* within 24 hours will fully charge within three hours.
5. If not returned within 24 hours, charging time of up to 8 hours may be required to fully charge batteries.
6. When not in the *Charger*, each *Pager* continues to indicate battery charge condition:
 - ▶ Flashing yellow light = Charge needed.
 - ▶ Flashing green light = OK to use.

**Charging and Storing Pagers:**

- ▶ To maintain maximum battery capacity, store *Pagers* in the powered (ON) *Charger*.
- ▶ If *Pagers* are left uncharged for more than 4 days, it is recommended to disconnect the batteries until their next use. See "Replacing the Battery" on page 11 for instructions.
- ▶ If left uncharged for extended periods of time, *Pager* batteries can damage beyond repair and will need to be replaced.
- ▶ When charged and stored properly, a battery life of 18-24 months can be expected before replacement is suggested.

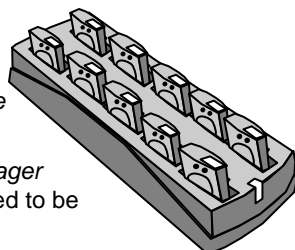

Paging Using a Desktop Controller:

1. Remove a *Pager* from the *Charger*.
2. The *Pager* will vibrate and it's LEDs will flash to confirm it is ready for use.
3. The *Pager* charge LED will continue to flash, confirming the it is ready to receive a page.
4. Enter the number of the *Pager* on the Controller.
5. Press # or SEND button to send the page.
6. The XMIT light on the Controller will turn ON, confirming the page is being sent.
7. The *Pager* will vibrate, tone or flash as required.
8. See "Enter Pager #" Menu instructions in your *Desktop Controller* manual for more information.

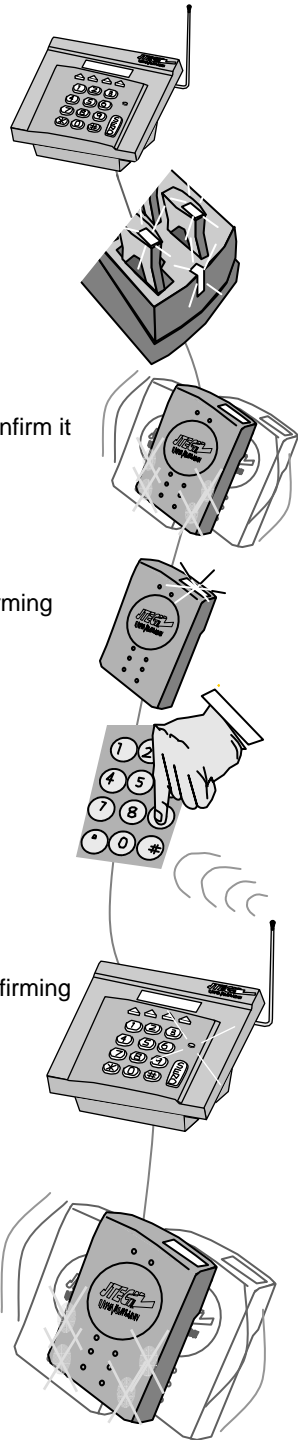

Paging Using a Kitchen Controller or Expeditor Panel:

1. Remove the *Pager* you wish to page from the *Charger*.
2. The *Pager* will flash and vibrate to confirm it is ready for use.
3. The *Pager* charge LED will continue to flash, confirming it is ready to receive a page.

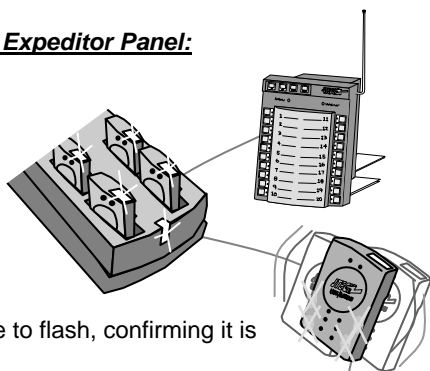

4. Press the number on the *Controller* or *Expeditor Panel* of the *Pager*.

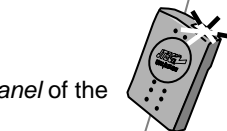

5. The light on the panel, next to that number will turn ON.

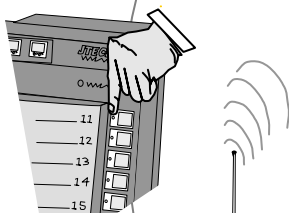

6. The XMIT light will turn ON for 2-3 seconds and turn off.
7. The *Pager* will receive a single, one second vibration (factory setting).

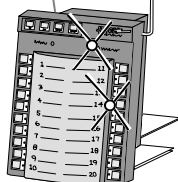

8. The light on the panel, next to that *Pager* number will continue to stay ON for 40 seconds (factory setting).
9. If a *Controller* and *Expeditor Panel* are combined, pressing a button on either panel will light both panels.

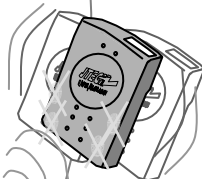

10. After 40 seconds (factory setting), the light next to the number pressed will begin to blink on the *Panel* or *Panels* for an additional 40 seconds (factory setting), before turning off.

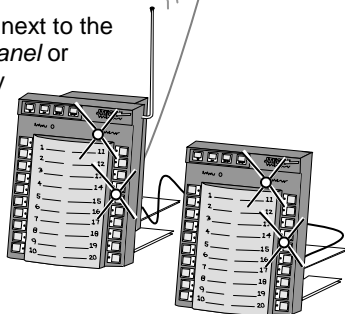

11. See Paging instructions in your *Kitchen Controller* manual for more information.

Paging Using a Desktop Controller and Telephone:
(Telco Module must be installed)

1. Remove the *Pager* you wish to page from the *Charger*.
2. The *Pager* will flash and vibrate to confirm it is ready for use.
3. The *Pager* charge LED will continue to flash, confirming it is ready to receive a page.
4. Pick up the phone and listen for the dial tone.
5. Dial the phone number that has been assigned to the *TELCO* Module installed.
6. Listen for a voice message from the telephone that confirms the *Controller* is ready.
7. Within 8-10 seconds, using the telephone keypad, enter the *Pager* number (up to 4 digits) and press the # button to send the page.
8. A voice message heard on the phone confirms the message was sent.
9. Hang up the telephone.
10. The *Pager* will receive a single, one second vibration (factory setting).
11. See Paging instructions in your *Desktop Controller* manual for more information.

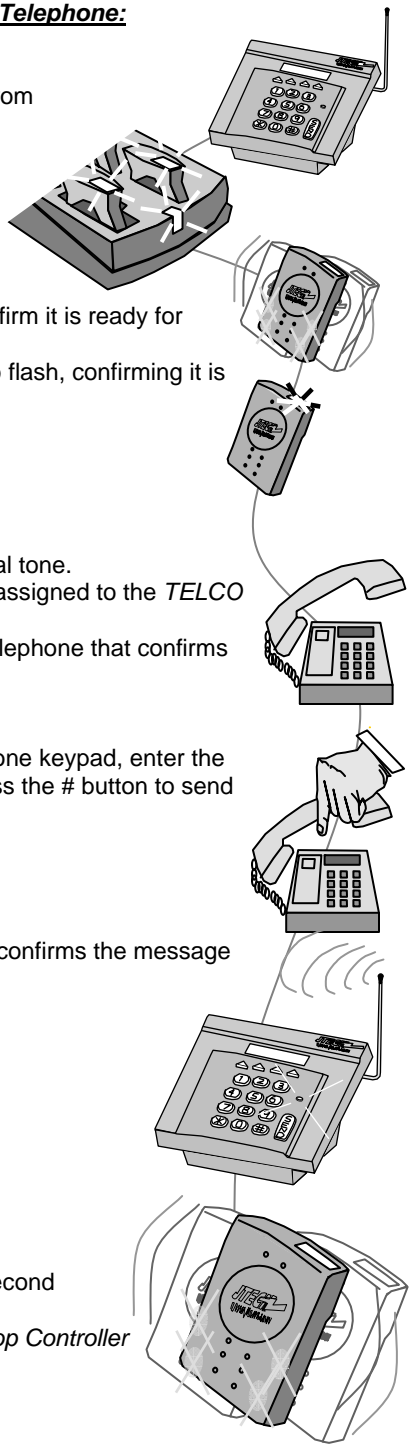

Replacing the Clip :

- There are 3 *Clip* attachments; *Metal*, *Spring* or *Paddle*.
- To replace a *Clip* or *Paddle*:
 1. Turn the *Pager* over.
 2. Push or pull the small plastic tab as shown in below and slide the *Clip* or *Paddle* off.
 3. Slide the new *Clip* or *Paddle* on until a “click” can be heard, locking the clip or paddle onto place.

Metal Clip:

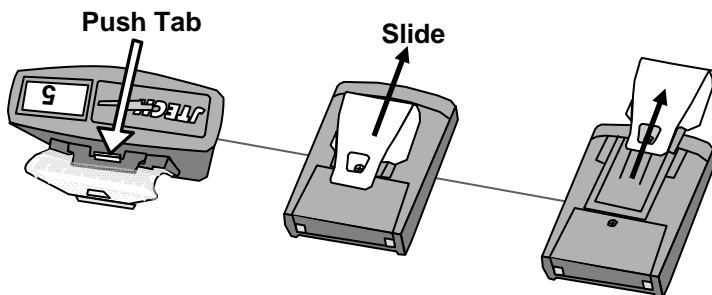

Spring Clip:

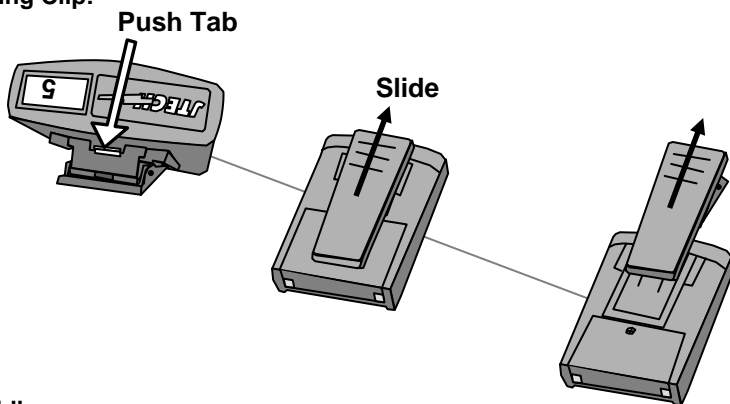

Paddle:

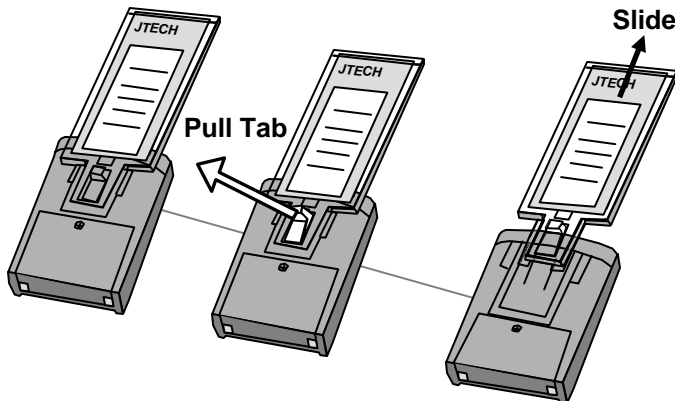

Replacing the Insert:

1. Turn the *Pager* over.
2. Using a flat blade screwdriver or equivalent to unlock the clear plastic cover.
3. Slide the clear plastic cover out.
4. Remove the *Insert*.
5. Replace with a new *Insert*.
6. Replace and slide the clear plastic cover into place. When inserted completely, the cover will “snap” into place.
7. Replace and tighten the screw (do not over tighten).

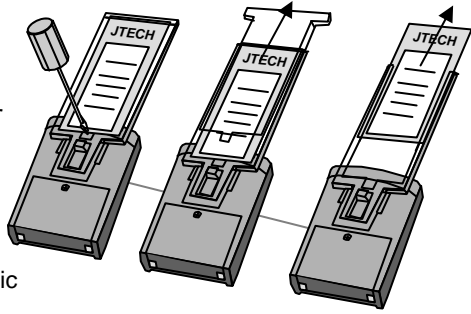

Inserts:

- *Inserts* can be professionally printed (call your JTECH sales representative for more details).
- Material thickness is 0.020" (5.1mm) maximum.

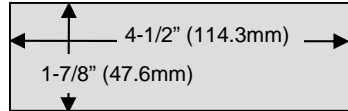

Insert Dimensions

Replacing the Battery:

1. Batteries that no longer charge properly or have a reduced operating time can be replaced by the user.
2. If using a *Spring Clip*, it must be removed to access the battery door screw.
3. Use a #1 Philips screwdriver to remove the screw.
4. Slide the battery door and *Pager Clip* off.
5. Carefully slip a screwdriver tip under the plastic wrapper on the battery pack and lift the battery out.
6. Unplug the battery connector.
7. Dispose of the Nickel Metal Hydride battery pack at any retail department or home improvement stores that recycles batteries.
8. Plug the new battery into the *Pager's* connector.
9. Push excess battery wire into the space next to the connector.
10. Press the battery into the *Pager* compartment.
11. Replace the battery door, clip and screw (do not over tighten).
12. Insert the *Pager* into the *Charger* and fully charge the battery.

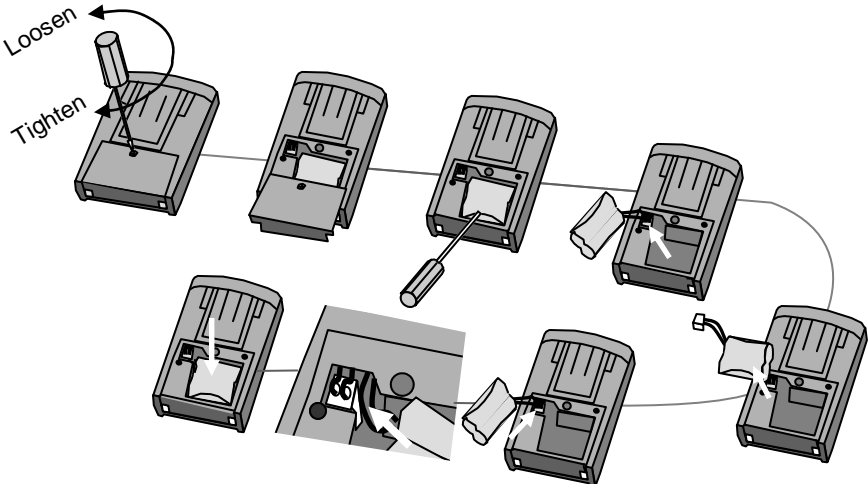

SYSTEM WARRANTY

JTECH Communications, Inc. warrants its equipment to be free from defects in materials and workmanship for a period of one year. Its obligation under this warranty is limited to repairing or replacing, at its own sole option, any such defective products. Products must be returned with transportation charges prepaid. All warranty returns must also include a JTECH-issued RMA number, clearly displayed on the interior and exterior of the package(s). This warranty does not apply to equipment which has been damaged by accident, negligence or misapplication or has been altered or modified in any way. This warranty applies only to the original purchaser.

The following are not covered under our one-year warranty: adapters, antennas, user-replaceable batteries, pager belt clips, pager promobacks, pager battery doors, or pager neck chains. Warranty also excludes liquid damage to master transmitter/controller (including base station, modules and any desktop or rack mount appliances), pagers, chargers or tablet hardware, lightning strikes or other acts of God that could affect the performance of the master transmitter/controller, pagers and peripherals.



6413 Congress Avenue
Suite 150
Boca Raton, Florida 33487
800-321-6221

Part Number 321045B5

© 2012, JTECH Communications, Inc. All Rights Reserved.