



The Bosch Battery Nationwide Warranty

Bosch batteries are warranted to be of merchantable quality and fit for the purpose for which they are designed and ordinarily used, and free under normal use and service from faults and defects in material and manufacturing.

The Bosch Battery Warranty is backed by a nationwide distribution network that means you and your customers will receive the back-up service and product replacement they need, when you need it. It's simple:

Should any battery be found faulty under the standard battery test outlined in this catalogue, due to faulty workmanship or materials, within the warranty period specified on the battery warranty label, it will be replaced by Century Yuasa Batteries Pty Ltd, or one of its approved representatives, free of charge for a battery of the same type.

This warranty is in addition to any conditions of warranties imposed or implied by any laws enforced in Australia.

It is a condition of this warranty that the sale receipt for the battery must be surrendered as proof of purchase when a claim is lodged, otherwise Century Yuasa Batteries retains the right to use the stamped supply date code on the battery terminal to determine age and length of service. This warranty is void if the battery fails due to after sales damage, neglect or incorrect use.

The Warranty Procedure Checklist

Before you issue a new battery under warranty the following standard battery test procedures must be adhered to. You may find that some warranty claims are nothing more than flat batteries.

- Check battery has not been damaged or abused after shipment from the supplier.
- Make sure battery container, cover terminals, vent plugs or clamp ledges are not broken.

- Test if battery has become defective as a result of overcharging or undercharging due to faulty vehicle electrical system.
- Make sure battery fluid level has not dropped below top of separators. Then check the specific gravity of the battery fluid with a hydrometer to test if the battery is simply flat and can possibly be recharged.
- Ensure codes and markings on battery terminals have not been tampered with.
- Check that a battery of smaller capacity than the minimum original equipment specification has not been used.
- Check proof of purchase to ensure battery is still within the warranty period. If satisfied all of the above are in order, fit free of charge battery. Keep old battery for checks by the Century Yuasa Representative. Help the Century Representative with claim documentation as requested.

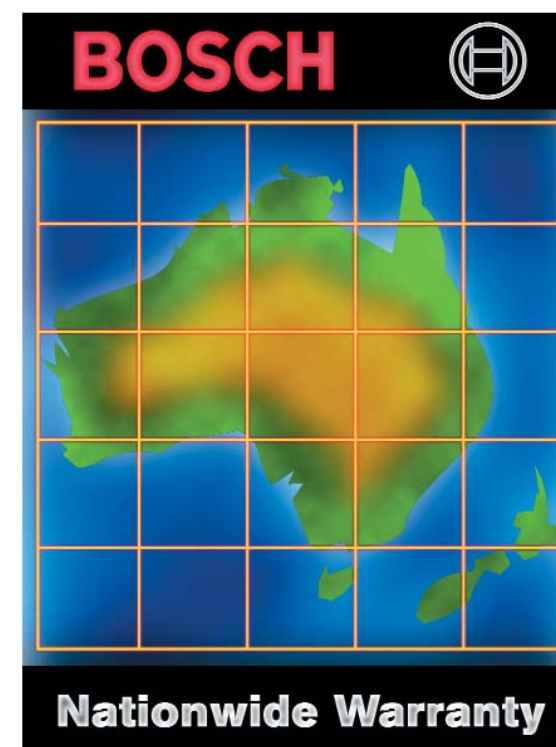

BOSCH maintenance free

Combats Heat



The standard Bosch Auto Range is now upgraded to superior Maintenance Free at exactly the same price!

All the benefits of a Bosch Maintenance Free will delight your customers and generate better business for you.

Maintenance Free gives maximum convenience and trouble-free battery life.

Once installed, your customers won't need to touch it again for years, under normal driving conditions. One of the best reasons to choose a Bosch.

Innovative Maintenance Free design.

Hotter motoring conditions can rapidly reduce the level of battery fluid and shorten its life. Bosch addresses this by engineering a new battery design with increased electrolyte coverage over the plates which contributes to longer life. It's a real battery breakthrough for today's more demanding motoring conditions, whether in exhausting city traffic or travelling long distances throughout the country.

A better battery means a better warranty, now 24 months.

Bosch is so confident in the new Gold, Silver and Bronze Maintenance Free battery range that it now gives a full 24 month warranty. You can rely on Bosch to give your customers the ultimate peace of mind while motoring.

Better safety when lifting.

Bosch wants to promote safe working practices so it has built in a convenient carry handle, which can be removed if necessary after installation.

Extreme Heat Condition? No problem!

Bosch has covered all the bases with Maintenance Free. As an extra safety measure, if your motoring customers find themselves in extreme heat conditions, new Bosch Maintenance Free has the provision to be topped up in the usual way - just in case.



GOOD. BETTER. BOSCH

BOSCH *navigator*

Tough • Powerful



Improved construction ensures greater reliability, backed up with an 18 month warranty!

Extra Tough Bosch Navigator is specially designed for recreation and rugged 4WD use.

Improved internal construction.

Good, Better, Bosch. It represents the promise of Superior Quality built into every Bosch product. None more so than the Navigator battery range. Through research, Bosch has further improved the renowned Navigator to give you even greater reliability when powering your 4WD.

Improved construction also gives you an increased warranty.

Bosch is a leading battery brand and enjoys an enviable reputation for quality. Bosch is so confident of the Navigator battery reliability that the warranty has been increased from 12 to 18 months for your complete peace of mind and is available from the Bosch nationwide network.

17 Extra Heavy Duty plates means more power.

Individual envelope separators surround the plates which minimise the possibility of shorting and reducing the battery life. Navigator also has extra 'reserve' power capacity which gives you an additional safety margin.

Bosch 'Hot Melt' polymers.

Bosch has incorporated stronger construction to handle the more extreme demands of 4WD applications. 'Hot Melt' polymers bind the battery plates together to resist vibration, especially when your vehicle is working in this country's more demanding conditions. This ensures a stronger battery and longer life.

Navigator represents excellent value.

The Bosch Navigator battery is purpose built for our country's rugged conditions and withstands the extra heavy duty demand imposed by four wheel drives. The Navigator is a Bosch premium quality battery which represents not only true value for money, but a valuable investment in reliability, powerful performance and long life.

BOSCH NAVIGATOR		
FEATURES:	BN70ZX	BN70ZLX
Description/Part Number	BN70ZX-11100	BN70ZLX - 11101
APN Number	9311831039918	9311831046190
Cranking Performance (CCA)	680	680
Reserve Capacity (minutes)	140	140
Number of Plates	17	17
Warranty Period	18 months	18 months
Separator Type	Envelope	Envelope
Hot Melt Plate Bond	yes	yes
Terminal Configuration	D - std.	C - std.
Carry Handles	yes	yes
Battery Dimensions:		
Length	305mm	305mm
Width	172mm	172mm
Total Height	225mm	225mm



GOOD. BETTER. BOSCH

Rugged • Powerful • Reliable



Designed to withstand wave impact and engine vibration to promote longer battery life!

The quality, purpose-built Marine battery range strong enough to handle all your on-board needs.

The right battery for the right job.

Bosch Marine Batteries are specially designed to handle the impact of pounding from heavy seas. A car battery is not designed for or recommended in marine applications. Safety is of paramount importance when out on the water and only a purpose-built marine battery should be installed.

Hot melt polymers bind the plates securely.

Wave impact and vibration in boats has been a problem for batteries for a long time. No longer with the new Bosch Marine range. Hot Melt polymers act as an anchor, to securely grip the plates and bind them together into a strong cell pack. This will minimise short circuits and help in extending battery life, while ensuring you get back without any trouble.

Starting and Deep Cycle.

Bosch marine batteries provide strong starting power plus deep cycle characteristics to power accessories like 2-way radios and depth sounders when you are at anchor.

Built-in carry handles for safety and convenience.

Marine batteries may need to be removed for long-term boat storage or re-charged because of lack of boat use. Bosch Marine batteries have convenient carry handles to help with fitting and removal, particularly if they are installed in restricted areas.

BOSCH MARINE		
FEATURES:	NS70M	N70ZM
Description/Part Number	BNS70M	BN70ZM
APN Number	9311831055154	9311831055161
Cranking Performance (CCA)	400	550
Reserve Capacity (minutes)	105	110
Number of Plates	13	15
Warranty Period	12 months	12 months
Separator Type	Glass mat	Glass mat
Hot Melt Plate Bond	yes	yes
Terminal Configuration	D - dual fit	C - dual fit
Carry Handles	yes	yes
Battery Dimensions:		
Length	258mm	305mm
Width	170mm	172mm
Total Height	232mm	230mm



GOOD. BETTER. BOSCH

Vehicle Jump Starting

WARNING

Modern vehicles with electronic management systems should not be jump started without “protected” jump starter leads and it is necessary to refer to the owner’s handbook for jump starting procedures for such vehicles. Vehicle Jump Starting procedure is as follows and should be followed carefully:

- Check batteries are the same voltage.
- Turn off all electrical loads, check vehicles are not touching and are in park or neutral.
- Check that vehicles have same terminal earthed. If not, refer to manufacturers instructions.
- Check that cables are not frayed or damaged.
- Carry out following steps in sequence:
 1. On negative grounded system, connect both ends of one cable to positive (+) terminal of both batteries.
 2. Connect one end of other cable to negative (-) terminal of booster battery.
 3. Connect other cable away from battery, to engine block or car frame of vehicle to be started.
 4. Make sure cables are away from fan blades and other moving vehicle parts.
 5. Start engine of booster car.
 6. Attempt to start engine of vehicle with discharged battery.
 7. If vehicle does not start within 30 seconds, call an auto electrician.
 8. After starting, remove cables in reverse order, starting with one connected to engine block or car frame.

This Hook-up for Negative Earthed Vehicles

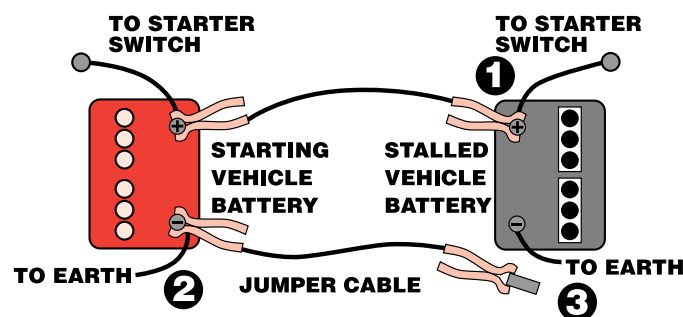

New Battery Installation

SAFETY PRECAUTIONS

Vehicles fitted with an Air Bag:

Removal or replacement of battery terminals will not unintentionally trigger an air bag system. However removal of battery terminals with the ignition remaining “on” can cause damage to electronic components, including the SRS.

Always check to ensure that the ignition is “off” before removing either of the battery terminals.

Before carrying out any work on the electrical system beyond the battery, the air bag system must be electrically disabled. Never indiscriminately probe the electrical wiring/connector in the vicinity of the steering column.

The wiring and harness connector of most air bag systems are bright yellow; do not interfere with any harness of this colour. As an added safety measure it is recommended that no person should remain seated behind the steering wheel while any electrical service work is carried out on the vehicle.

GENERAL PRECAUTIONS:

1. Make sure the engine, lights and any accessories are turned off before removing old battery.
2. Check if vehicle has a computerised electrical system.
3. Vehicles with on board computer systems require an alternative power source to maintain electronic memory when battery is disconnected.
4. Disconnection of the battery on such a vehicle may cause damage to the main computer or other segments of the vehicle’s electronically controlled equipment, without a memory minder.

REMOVAL OF OLD BATTERY:

1. Note location of positive terminal and mark polarity on positive cable. Remove the ground terminal first. This precaution is necessary to avoid damage to wiring and the battery by accidentally grounding tools.
2. Remove second terminal. Undo hold down and remove battery.

NEW BATTERY INSTALLATION:

1. Inspect tray and area for corrosion. If necessary, scrub the area with water and baking soda and rinse with water.
2. Corroded steel parts should be dried and painted with acid proof paint. Terminals should be cleaned and brushed.
3. Cable and starter motor connections should be checked and tightened if necessary.
4. If terminal clamps or cables are badly corroded, they should be replaced.
5. Place the new battery in the tray ensuring it sits level and that terminal posts are positioned as for the old battery.
6. Place and tighten hold downs securely so that the battery cannot move in the tray.
7. Apply a thin coating of high temperature grease to the posts and cable connections.
8. Replace cables ensuring that the ground terminal is connected last. Tighten connections.

NB: Do not over tighten.

Never hammer cable connections onto battery posts, as this can damage the battery posts and cover.

Charging Batteries

Before attempting to charge a battery, be aware of all the safety precautions you should observe during the charging operation.

- Always turn the charger off before attaching, rocking, or removing the terminal clamps.
- Keep vent caps in place.
- Keep open flames and sparks away from the battery.
- Charge in well ventilated area.
- Follow the battery charger manufacturer’s instructions.

Specific charging rates or times are difficult to detail due to a number of other features such as:

1. The electrical capacity of the battery.
2. Temperature of the electrolyte.
3. Battery state of charge at the start of the charging period.
4. Battery age and condition.

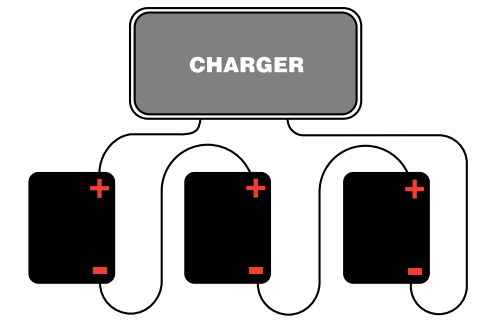

Series Charging

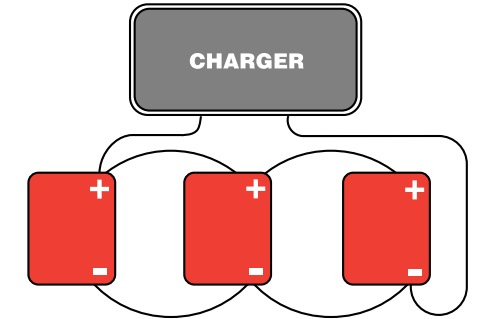

Parallel Charging

Battery Charging Guide

6-Volt and 12-Volt batteries recommended charging rate and time from a Fully Discharged Condition (ie. Flat, Discharged). Fast Recharging is not Recommended.		
RATED BATTERY CAPACITY (RESERVE MINUTES)	SLOW CHARGE	FAST CHARGE
80 Mins or Less.	15 hrs. @ 3 Amps	2,5 hrs. @ 20 Amps 1.5 hrs. @ 30 Amps
Above 80 to 125 Mins.	21 hrs. @ 4 Amps	3,75 hrs. @ 20 Amps 1,5 hrs. @ 50 Amps
Above 125 to 170 Mins.	22 hrs. @ 5 Amps	5 hrs. @ 20 Amps 2 hrs. @ 50 Amps
Above 170 to 250 Mins.	23 hrs. @ 6 Amps	7,5 hrs. @ 20 Amps 3 hrs. @ 50 Amps
Above 250 Mins.	24 hrs. @ 10 Amps	6 hrs. @ 40 Amps 4 hrs. @ 60 Amps

Check the specification page for the Reserve minutes.

Battery Safety

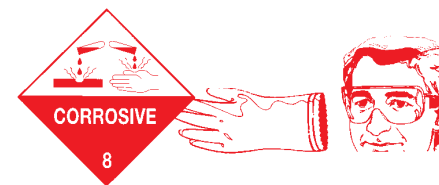

• BATTERY ACID CAN CAUSE BURNS.

Use extreme care when handling acid.

If electrolyte is spilled or splashed onto clothing or the body, wash with water and neutralise with a solution of baking soda and water. Electrolyte splashed into eyes is extremely dangerous. If this occurs, gently open eyes and wash with cool clean water for 5 minutes. Call a doctor.

• IF ELECTROLYTE IS SWALLOWED:

Drink large quantities of water or milk and follow with milk of magnesia, beaten eggs or vegetable oil. Call a doctor.

If it is necessary to prepare electrolyte:

Always add concentrated acid to water - never water to acid. Store electrolyte in plastic containers with sealed cover.

Do not store in the sun.

• EXPLODING BATTERY:

Batteries generate explosive gases during vehicle operation and when charged separately.

Flames, sparks, burning cigarettes or other ignition sources must be kept away at all times.

• ALWAYS SHIELD EYES WHEN WORKING NEAR BATTERIES:

When charging batteries, work in a well ventilated area - never in a closed room. Always turn battery charger or ignition off before disconnecting a battery.

BOSCH IS ENVIRONMENTALLY CONSCIOUS

Every Bosch battery now carries the Recycle Logo.

It’s a fact that up to 97% of each Bosch battery is recyclable, meaning Bosch takes environmental issues seriously. Bosch prides itself on being a good corporate citizen. Today’s customers will find our concern very reassuring and they can choose Bosch with confidence.



Why did the battery fail?

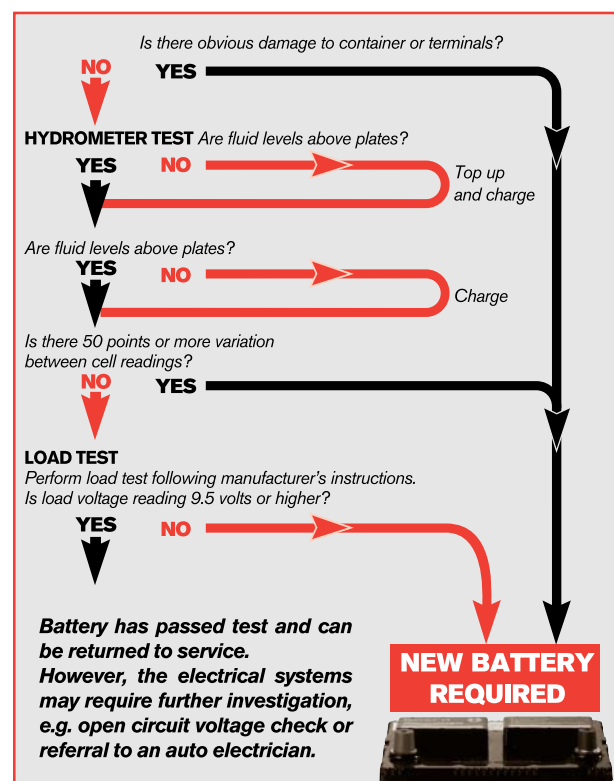

It is important that the reason for any battery failure is identified, as a battery replacement may only solve the symptom of the problem.

BATTERY INSPECTION

Check electrolyte level - fluid below the tops of the separators indicates overcharging or poor maintenance. Overcharge condition may be due to incorrect voltage setting, low voltage caused by heat or internal defects, or old age deterioration. Is there electrolyte on the top of the battery? This can indicate overcharging or over filling. Is the battery loose in the carrier? This can cause failure from vibration. Has the battery signs of damage or mistreatment? This can also cause failure.

DISCHARGED (FLAT) BATTERIES

A flat battery should be checked with a Hydrometer. A low Specific Gravity reading of 1.220 or less, in all cells indicates a discharged battery and it must be charged before further examination and testing can occur.

The discharged condition may be due to a problem in the electrical system (slipping alternator belt, poor voltage regulator, faulty alternator, high resistance due to corrosion). Internal shorts may also be due to manufacturing defects, or shorts through the aging process or vibration damage.

OLD AGE

Batteries have an average age of 2-3 years. Assessment of the life of the battery can be done by checking the sale code of the battery terminal. Bosch Batteries have a code which uses a letter and a number.

Numbers are 0-9

Example: A battery date coded A5 was dispatched by

Century Yuasa in January 1995. A battery date coded M4 was dispatched by Century Yuasa in December 1994 etc.

A	January	G	July
B	February	H	August
C	March	J	September
D	April	K	October
E	May	L	November
F	June	M	December

FACTORS AFFECTING BATTERY LIFE

Automotive batteries have an average 'life' of 2-3 years. Over that age they gradually lose their capacity as their function is performed. They constantly charge and discharge which eventually leads to failure.

Components corrode over time, electrical shorts occur in the battery, vibration causes damage that eventually causes failure. Overcharging and undercharging of a battery will also have a bearing on battery life.

Try to follow charging procedures correctly. Battery servicing as detailed, helps extend battery life. Batteries fail when least expected.

The usual warning is a slower than normal battery ability to crank the engine but other less noticeable factors such as changed driving patterns (holidays), colder or hotter weather will all have an effect on the life of a battery. Encourage your customers to ask for a 'FREE Battery Test'. It's good public relations and if the battery is old it may lead to a sale.

IS BATTERY REPLACEMENT NECESSARY?

A percentage of batteries, allegedly faulty, are merely "flat" or discharged so the battery (and sometimes the vehicles electrical system) needs to be checked - refer battery test procedures and installation.

GENERAL BATTERY INFORMATION

- Vehicle batteries last for an average of 2-3 years. They wear out like tyres and need to be replaced.
- Vibration can reduce a battery life. Bosch starting batteries have Polyethylene Envelopes around each positive plate which catch active material and help to prevent short circuits thereby ensuring long battery life.
- Many alleged 'dead batteries' are merely flat batteries. Drivers simply leave lights on or can have faulty voltage regulators. Make sure you go through the warranty procedure check thoroughly before replacing a battery.
- It's impossible to know exactly when a battery might fail. A slow starting engine could be a fair indication. Old batteries can give trouble in colder weather. Equally, if an engine area becomes overheated in very hot weather and the battery is under strain from air conditioners it may fail.
- Regular battery checks are always advised.

Stock storage and rotation procedure

Proper stock management and rotation procedures are essential to ensure only first class stock is presented for sale to customers.

- Batteries are a perishable product with limited shelf life.
- Stock them upright in a cool place. Do not store in direct sunlight. Charged batteries displayed in the sun will require recharge within 6-8 weeks.
- Do not over stock as this will cause a rotational problem, and require additional battery service to maintain the battery in saleable condition.
- Rotate stock on a 'First in - First out' principle. Place older batteries at the front of your display.

Battery Servicing

Battery servicing can be carried out during vehicle servicing or during a normal refuelling stop. Routine servicing of the battery should include the following:

1. Check for defective cables, loose connections, corrosion, cracked cases or covers, loose hold downs and deformed or loose terminal posts.
2. Correct if possible, replace or repair parts that are damaged.
3. Where there is corrosion on the terminal posts or on hold down trays, it is recommended that the whole area be neutralised, cleaned and painted. This can be done using a wire brush, paint scraper and a solution of water and bicarbonate of soda (Baking Soda).
4. Check the electrolyte level. If it is below the separator tops, add clean distilled or good quality water to bring it back to the correct level. Never over fill cells as this will cause corrosion.

How to select the right battery for the vehicle

Modern vehicles require more power than ever before. Electronic ignitions and management systems in modern vehicles require the battery voltage to be maintained at a higher percentage of charge to that of a few years ago. With all the original manufacturer equipment, plus added optional equipment, it is very important to fit the correct replacement battery, with an adequate reserve.



STORAGE OF WET BATTERIES

- Batteries have limited shelf life.
- Proper stock management and rotation procedures are essential to ensure only first class product is sold to customers.
- Store batteries upright in a cool dry place.
- Do not store on hard uneven surfaces, which may damage the container
- Do not overstock - metropolitan sites: no more than 4 weeks stock country sites: no more than 6 weeks stock remote area sites: no more than 8 weeks stock

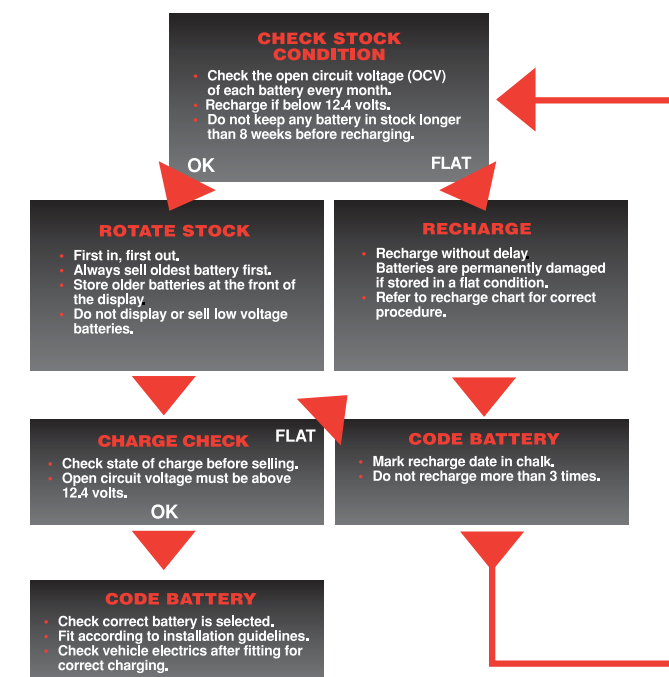

Battery Power Ratings

Customer Service

THERE ARE TWO DISTINCT FUNCTIONS FOR THE MODERN VEHICLE BATTERY.

1. The power to start or crank the engine.
2. The power to operate all the accessories that are in addition to the engine - lights, air conditioners, radio, power windows, etc.

STARTING POWER IS KNOWN AS COLD CRANKING AMPS (CCA)

Many people mistakenly think that the number of plates in a battery is the indication of the power of the battery - ie. more plates means more power! While this can be, it's not always necessarily the case. A standardised system was developed whereby a more accurate comparison between batteries could be made. The surface area of the plates exposed to the battery acid is what determines the potential power. Meaning, less plates with a bigger area may provide more power than more plates with smaller surface area. That's why CCA's has been adopted as the only true comparison of starting power between batteries.

ACCESSORIES POWER

The measure commonly used for expressing the capacity of a battery to provide power for accessories is Reserve Capacity. The Amp Hour Capacity is a measurement of the amps a battery can deliver continuously over 20 hours. This rating applies only to Deep Cycle batteries.

Technical definitions of CCA's, Amp hours and Reserve Capacity appear below.

PERFORMANCE AND TECHNOLOGY

1. **COLD CRANKING AMPS (CCA)** is a measure of the engine cranking capability of a battery. CCA is the current in amperes that a new, fully charged battery (at -18° C) can deliver for 30 seconds and maintain a terminal voltage (under load) of 1.2 volts per cell or more, (7.2 volts for a 12 volt battery).
2. **RESERVE CAPACITY** (minutes) represents the time a battery can supply the electrical load of a vehicle in the event of a failure of the charging system. Reserve Capacity is the time in minutes that a new, fully charged battery at 25° C will deliver 25 amperes down to a terminal voltage (under load) of 1.75 volts per cell (10.5 volts for a 12 volt battery)

Century Yuasa Batteries are a prominent manufacturer and distributor of automotive batteries in Australia and our people are experts when it comes to batteries. These key people are battery specialists and are there to help build your battery business.

FULL SERVICE DELIVERY

Our Century Yuasa Battery sales representatives will facilitate full delivery service for all of your battery requirements.

Our representatives will:

- Personally deliver and place batteries on your stand
- Rotate your stock
- Promptly handle all warranties
- Assist with staff training
- Maintain current point-of-sale material
- Implement promotional programs

NATIONWIDE NETWORK

Century Yuasa Batteries national network of battery distributors is designed to satisfy your needs through a fast and efficient battery delivery service.

Additional to our normal service offer in metropolitan and selected regional areas, we have developed a new Sales Support Service called "Sales Access". It's easier, faster and far more convenient for you!

SALES ACCESS

'Sales Access' includes all the components of our personal full service delivery, plus:

Our highly trained consultants will give you a call at a mutually agreed time on a specific day to take your order. You can also call 'Sales Access' to place orders outside your agreed call cycle to immediately handle all your enquiries.

Our 'Sales Access' consultants are ready to take your order, or handle any enquires you have.

PHONE 1300 361 161
FAX ORDER 1300 361 660

Metropolitan areas: Next day delivery
Most Country areas: 2-3 day delivery
Emergency orders are available when required.

BATTERY ASSEMBLIES

6 VOLT BATTERIES

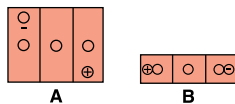

12 VOLT BATTERIES

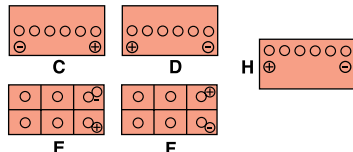

Bosch Heavy Duty battery is suitable for basic vehicle accessories such as:

1. Standard Vehicle Lighting
2. Window Heater / Demister
3. Radio / Cassette / CD Player
4. Electronic Fuel Injection

Bosch Extra Heavy Duty battery is recommended if two or more of these accessories are present:

1. Electric Aerial
2. Burglar Alarm
3. Electric Windows
4. Central Locking System
5. Electric Sun Roof
6. Fog Lights
7. Spot Lights
8. Mobile Phone
9. Air conditioning
10. Electronic Instrument Display

In selecting the right battery for your vehicle, these choices should be considered

ABBREVIATIONS

CH Carry Handles	SL Side Ledge
CV Central Vent	SP Small Terminal Post
DF Dual Fit	SR Side Recess
EL End Ledge	STD Standard Terminal Post
GM Glass Mat Around Positive Plate	VR Vibration Resistant
HN Hexagon Nut Terminal	WN Wing Nut Terminal
RP Recessed Terminal Post	

Australian standard specifications as shown AS 2149

BOSCH AUTOMOTIVE & MARINE PRODUCT RANGE

BOSCH TYPE	VOLTS	PLATES	COLD CRANK AMPS @ -18c	RESERVE MINS @25c	NOMINAL OVERALL DIMENSIONS (MM)			ASSEMBLY	TERMINAL TYPE	SPECIAL FEATURES
					L	W	H			
GOLD										
BNS40MF	12	11	360	54	195	127	220	D	STD	SR
BNS40LMF	12	11	360	54	195	127	228	C	DF	SR
B51MF	12	11	360	55	238	130	198	D	STD	
B53MF	12	11	360	55	238	130	198	C	DF	DF
B67MF	12	13	520	95	235	172	212	D	STD	EL, SL, CH
B68MF	12	13	520	95	235	172	220	C	DF	EL, SL
SILVER										
BNS40ZS	12	9	280	45	195	127	225	D	STD	SR
BNS40ZLS	12	9	280	45	195	127	228	C	DF	DF, SR
BNS40Z	12	9	280	45	195	127	230	D	SP	SR
BNS40ZL	12	9	280	45	195	127	230	C	SP	SR
BNS60	12	12	350	60	236	128	224	D	SP	
BNS60L	12	12	350	60	236	128	224	C	SP	
BNS60S	12	12	350	60	236	128	224	D	STD	
BNS60LS	12	12	350	60	236	128	224	C	STD	
B41	12	9	280	45	238	135	200	D	STD	
B43	12	9	280	45	237	135	200	C	DF	DF
B57MF	12	11	440	95	239	172	210	D	STD	SL
B58MF	12	11	440	95	239	172	218	C	DF	DF, SL
B57EF	12	11	440	95	228	172	210	D	STD	
B58EB	12	11	440	95	228	172	210	C	DF	
B58VT	12	11	430	95	235	172	208	C	STD	
B55D23R	12	11	430	95	230	172	223	D	STD	SL
B55D23L	12	11	430	95	230	172	223	C	STD	SR
BRONZE										
B46	12	9	380	75	239	172	210	D	STD	SL
B47	12	9	380	75	239	172	218	C	DF	DF, SL
EUROPEAN										
B03	6	11	270	80	184	167	186	A	STD	SL
BM96-12	12	9	300	55	200	175	175	C	STD	RP, SL
BDIN53L	12	13	480	75	246	175	175	C	STD	CV, EL RP, SL
BDIN53R	12	13	480	75	246	175	175	D	STD	CV, EL RP, SL
BDIN65L	12	15	500	95	277	175	175	C	STD	CV, EL RP, SL
BDIN85L	12	19	600	135	352	175	175	C	STD	CV, EL RP, SL
BDIN95L	12	23	720	165	352	175	188	C	STD	CH, CV, EL, RP, SL
HEAVY DUTY TRUCK										
BN50Z	12	11	450	95	258	170	225	D	STD	CH
BN50ZL	12	11	450	95	258	170	225	C	STD	CH
BNS70	12	13	520	110	258	170	225	D	STD	CH
BNS70L	12	13	520	110	258	170	225	C	STD	CH
BN70Z(13)	12	13	510	120	305	172	225	D	STD	CH
BN70Z(15)	12	15	600	140	305	172	225	D	STD	CH
BN70ZL(15)	12	15	600	140	305	172	225	C	STD	CH
BN70ZX (Navigator)	12	15	680	135	305	172	225	D	STD	CH, GM, PL, VR
BN70ZXL (Navigator)	12	15	680	135	305	172	225	C	STD	CH, GM, PL, VR
B86	12	15	600	160	348	175	237	C	STD	CH
B87	12	15	600	160	348	175	237	D	STD	CH
B86Z	12	17	680	180	348	175	237	C	STD	CH, PL, SR
B89	12	13	680	210	345	175	285	C	STD	CH, VR,
B86MF	12	16	700	160	330	173	235	H	STD	SR
B26	6	25	770	260	300	175	220	A	STD	CH, VR
B94	12	19	800	240	505	215	205	E	STD	CH
BN100	12	17	650	180	405	175	235	D	STD	CH, GM
BN120	12	21	700	230	505	180	240	F	STD	CH, GM
BN150	12	25	800	270	505	225	235	F	STD	CH, GM
BN200	12	31	1000	380	520	275	240	F	STD	CH, GM
MARINE										
BNS70M	12	13	400	105	256	170	232	D	DF	CH, PL
BN70ZM	12	15	550	110	305	172	230	D	DF	CH, GM, PL

DEEP CYCLE PRODUCT RANGE										BOSCH
BOSCH TYPE	VOLTS	PLATES	CAPACITY 20HR @ 25c	NOMINAL OVERALL DIMENSIONS (MM)			ASSEMBLY	TERMINAL TYPE	SPECIAL FEATURES	
				L	W	H				
DEEP CYCLE										
B12A	6	17	105	227	173	205	A	STD	GM	
BGC2	6	19	200	260	180	275	A	STD/WN	GM,SR,WN	
B43T	12	7	40	238	135	215	C	DF	CH,GM	
B46T	12	9	50	235	175	205	D	STD	CH,GM,VR	
B47T	12	9	50	235	175	210	C	DF	CH,GM,VR	
BNS70T	12	11	65	257	171	249	D	STD/WN	SL,WN,CH	
N70T	12	13	75	305	175	225	D	STD	CH,GM,VR	
B86T	12	15	85	350	175	240	C	STD	CH,GM,VR	
BATTERY COMPARISON CHART										
BOSCH	CENTURY	YUASA	BESCO	G FORCE	RACQ	S/CHGE	EXIDE	APOLLO	JIS Type	
B67MF	67			67			E530H		70D23R	
B68MF	68			68			E530H			
B57MF	57	57			57		E470H		65D23R	
B58MF	58	58			58		E470H		65D23L	
BNS40MF	NS40ZS	NS40ZS			NS40ZXS	EP50	E360D		SY70-S4	
BNS40LMF	NS40ZLS	NS40ZLS			NS40ZXS	EP52	E360C		SY70-DL	
B51MF	51			51			E370D			
B53MF	53			53			E370C			
B46	46	46	46	46	46	NS50Z	LM380D	N48		
B47	47	47	47	47	47	NS50ZL	LM380C	N49		
B57MF	57	57	57	57	57	NS50P	LM430D	N50		
B58MF	58	58	58	58	58	NS50PL	LM430C	N51/51F		
B57EF	57EF		57EF		57EF		LM430E			
B58EB	58EB		58EB		58EB		LM430F	N51EB		
B58VT	58VT		58VT		58VT		LM430G			
B55D23R	55D23R	55D23R	55D23R		55D23R		55D23R		55D23R	
B55D23L	55D23L	55D23L	55D23L		55D23L		55D23L		55D23L	
B41	41	41	41	41	41	N41	LM250D	N40M		
B43	43	43	43	43	43	N43	LM250C	N39		
B51MF		51			51		LM300D			
B53MF		53			53		LM300C			
BNS40Z	NS40Z	NS40Z	NS40Z	NS40Z	NS40Z	NS40Z	LM280D	NS40	36B20R	
BNS40ZL	NS40ZL	NS40ZL	NS40ZL	NS40ZL	NS40ZL	NS40ZL	LM280C	NS40L	36B20L	
BNS40ZS	NS40ZS	NS40ZS	NS40ZS	NS40ZS	NS40ZS	NS40ZA	LM280A	NS40ZA	36B20R(S)	
BNS40ZLS	NS40ZLS	NS40ZLS	NS40ZLS	NS40ZLS	NS40ZLS	NS40ZAL	LM280BE	NS40ZAL	36B20L(S)	
BNS60	NS60	NS60	NS60		NS60	NS60	NS60	NS60	46B24R	
BNS60L	NS60L	NS60L	NS60L		NS60L	NS60L	NS60L	NS60L	46B24L	
BNS60S	NS60S	NS60S	NS60S		NS60S	NS60S			46B24R(S)	
BNS60LS	NS60LS	NS60LS	NS60LS		NS60LS	NS60LS		46B24L(S)		
B03	03	03	03		03	N03	N03	N03		
BM96-12	M96-12	M96-12	M96-12		M96-12	37A	37A			
BDIN53L	DIN53L	DIN53L	DIN53L		DIN53L					
BDIN53R	DIN53R	DIN53R	DIN53R		DIN53R					
BDIN65L	DIN65L	DIN65L	DIN65L		DIN65L					
BDIN85L	DIN85L	DIN85L	DIN85L		DIN85L					
BDIN95L	DIN95L	DIN95L	DIN95L		DIN95L					
B26	26	26	26	26		N25	26B	N22Z		
BN50Z	N50Z	N50Z	N50Z	N50Z	N50Z	N50Z	N50Z	N50Z	55D26R	
BN50ZL	N50ZL	N50ZL	N50ZL	N50ZL	N50ZL	N50ZL		N50ZL	55D26L	
BNS70	NS70	NS70	NS70	NS70	NS70	NS70	N50ZZ	N52	75D26R	
BNS70L	NS70L	NS70L	NS70L	NS70L	NS70L	NS70L	N50ZZL	N53	75D26L	
BN70Z13	N70Z13		N70Z13	N70Z13	N70Z13	N70Z	N70Z	N70Z	65D31R	
BN70Z15	N70Z15	N70Z15	N70Z15	N70Z15	N70Z15	N86S	N70ZZ	N70ZZ	95D31R	
BN70ZL15	N70ZL15	N70ZL15	N70ZL15	N70ZL15	N70ZL15	N86SL	N70ZZL	N70ZZL	95D31L	
BN70ZX		N70ZZ							105D31R	
BN70ZXL		N70ZZL							105D31L	
B86	86	86	86	86		N87L	86B	N87		
B87	87	87	87	87		N87	86A	N86		
B86Z	86Z					87LZ	86BX			
B86MF	86ZMF	86ZMF	86ZMF					N89S		
B89	89	89	89			N89	89B	N89T		
B94	94	94	94			94	94B	N94		
BN100	N100	N100	N100			N100	N100D	N100	105E41R	
BN120	N120	N120	N120			N120	N120	N120	115F51	
BN150	N150	N150	N150			N150P	N150	N150	145G51	
BN200	N200	N200	N200			N200P	N200	N200	190H52	

BOSCH		PASSENGER VEHICLES		
MAKE	MODEL	STANDARD Part No.	HEAVY DUTY Part No.	PREMIUM Part No.
ALFA ROMEO				
1964-85	All Models (except as listed)	B46	B57MF	B67MF
1974-92	Alfasud (All models)	BDIN53L		
1974-92	Alfa 33	BDIN53L		
1985-on	Alfa 75, 75TS, 75V6	BDIN65L		
1985-on	Alfa 90	BDIN65L		
2000-on	156	BDIN53L		
1989-92	164 3.0L	B47	B58MF	B67MF
2000-on	166	BDIN85L		
1980-84	Guilietta	BDIN53L		
1976-86	GTV	BDIN53L		
1989-92	GTV	B47	B58MF	B67MF
1989-92	GTV6	B47	B58MF	B67MF
1999-on	GTV V6	BDIN65L		
1982-on	Sportiva	BDIN65L		
1985-on	Spider	B46	B57MF	B67MF
2000-on	Spider	BDIN65L		
1979-86	Sprint	BDIN53L		
ASTON MARTIN				
1957-87	All Models	BN70Z(13)	BN70Z(15)	BN70ZX
ASIA				
1992-93	Ceres Rocsta	B47	B58MF	B68MF
1994-on	Ceres Diesel	BN70Z(13)	BN70Z(15)	BN70ZX
1994-on	Rocsta	B55D23L		
AUDI				
1982-91	Estate, 100	BDIN53L		
1974-89	Fox 80, 80S, 80 Quattro, GL, GLS	BDIN53L		
1974-89	Fox, 100GL, LS, 5E	BDIN53L		
1990-on	Quattro V8 Sedan	BDIN65L		
1967-73	Super 90, 100LS	B47	B58MF	B68MF
1979-on	5+5	BDIN65L		
1984-on	701	BDIN65L		
1990-on	80 2.0E, 2.3E, 2.8E	BDIN65L		
1994-on	80 4Cyl	BDIN53L	BDIN65L	
1994-on	80 6Cyl	BDIN65L		
1974-89	90 Series	BDIN53L		
1974-89	100CD	BDIN53L		
1994-on	100 6Cyl	BDIN65L		
1982-91	200 (Turbo)	BDIN53L		
1974-91	200T	BDIN53L		
1995-on	A4 1.8	BDIN53L		
1995-on	A4 1.8 turbo	BDIN65L		
1996-on	A8	BDIN85L		
1993-on	S4	BDIN53L		
BENTLEY				
1947-89	All Models	BN70Z(13)	BN70Z(15)	BN70ZX
1990	All Models	BNS70	BN70Z(15)	BN70ZX
BMW				
1976-	Alpine	BDIN53L	BDIN65L	
1967-75	2000, 2002	BDIN53L		
1968-78	2500, 2800	BDIN53L	BDIN65L	
1968-78	3.0L, 3.3L	BDIN53L	BDIN65L	
1976-94	318, 320, 4 cyl (under bonnet)	BDIN53L		
1991-on	3 series (in Boot)	BDIN65L		
1991-on	3 series (under Bonnet)	BDIN53L		
1976-on	All 5 series 6 cyl. (under bonnet)	BDIN65L		
1987-on	All 5 series (under seat)	BDIN65L	BDIN85L	
1978-88	633CSI, 635CSI	BDIN65L	BDIN85L	
1976-on	All 7 series 6 cyl. (under bonnet)	BDIN65L		

PASSENGER VEHICLES



MAKE	MODEL	STANDARD Part No.	HEAVY DUTY Part No.	PREMIUM Part No.
BMW - continued				
1987-on	All 7 series (under seat)	BDIN65L	BDIN85L	
1990-on	8 series	BDIN65L (x2)	BDIN85L (x2)	
BUICK				
1956-89	All Models	BN70Z(13)	BN70Z(15)	BN70ZX
1990-on	All Models	BN50Z	BNS70	
CADILLAC				
1956-82	All Models	BN50Z	BNS70	
1982-90	All Models	BN70Z(13)	BN70Z(15)	BN70ZX
CHEVROLET				
1956-91	All Models	B46	B57MF	B67MF
CITROEN				
1990-on	AXGT5	BDIN65L		
1986-90	BX1	B47	B58MF	B68MF
1986-on	BX16TRX, BX19GT	BDIN53L		
1976-83	CX2200, CX2400	B47	B58MF	B68MF
1984-85	CX2500IE, CX Pallais	BDIN53L		
1959-78	D Series, DS Series	B46	B57MF	B68MF
1976-88	Diesel Models	BDIN65L	BDIN85L	
1972-78	GS, GS Club, GS Pallais, GS 1200, 1220	BDIN53L		
1990-94	XM V6 Auto (HB)	BDIN53L		
1994-on	Xantia	BDIN53L		
DAEWOO				
1994-97	1.5i	BDIN53L		
1996-97	Cielo, GL	BDIN53L	BDIN65L	
1994-97	Espero	BDIN53L	BDIN65L	
1997-on	Espero 2.0l	BM96-12		
1998-on	Ceros	BDIN53R #		
1999-on	Lanos	BDIN53R #		
1998-on	Leganza	BDIN53R #		
1998-on	Nubira	BDIN53R #		
DAIHATSU				
1966-87	All models	BNS40Z	BNS60	
1990-94	Applause	BNS40Z	BNS60	
1994-on	Applause	BNS40ZL	BNS60L	
1996-	Centra	B43	B53MF	
1983-91	Charade	BNS40ZL	BNS60L	
1991-96	Charade	B43	B53MF	
1996-on	Charade, Charade Centro	BNS40ZL	BNS60L	
1999-on	Charade	BNS40ZL		
1999-on	DX 4WD	BNS40Z	BNS60	
1988-on	Feroza 4WD (Petrol)	BNS40Z	BNS60	
1988-on	Feroza 4WD (Diesel)	BN100 **		
1999-on	Handi	BNS40Z		
1983-85	HiJet Van, Super DeLuxe	BNS40Z	BNS60	
1971-75	Max S38, S40, S80	B12N24-4		
1990-94	Mira	BNS40Z	BNS60	
1994-on	Mira	BNS40ZL	BNS60L	
1998-on	Pysar	BNS40ZL	BNS60L	
1999-on	Pysar	BNS40ZL		
1983-on	Rocky (Petrol)	BNS40Z	BNS60	
1984-on	Rocky Diesel	BN100 **		
1982-83	Scat	BNS40Z	BNS60	
1982-83	Scat Diesel	BN100 **		
1998-on	Sirion	BNS40ZL		
1998-on	Terios	BNS40ZL	BNS60L	
1999-on	Terios 4WD	BNS40ZL	BNS60L	
DAIMLER				
1953-79	All models (Incl. Vanden Plas)	BN50Z	BNS70	

Requires battery packer to increase height

** Adjustment to clamps may be required



PASSENGER VEHICLES

MAKE	MODEL	STANDARD Part No.	HEAVY DUTY Part No.	PREMIUM Part No.
DAIMLER - continued				
1987-on	Daimler 3.6	BN70Z(13)	BN70Z(15)	BN70ZX
1990-on	Daimler 4.0	BN70Z(13)	BN70Z(15)	BN70ZX
1987-on	Double Auto/Double 6	BN70Z(13)	BN70Z(15)	BN70ZX
1967-70	Sovereign	BN70Z(13)	BN70Z(15)	BN70ZX
1970-86	Sovereign	BN50Z	BNS70	
1986-92	Sovereign	BN50Z	BNS70	
DATSUN (REFER NISSAN)				
EUNOS				
1993-on	30X V6	B55D23L		
1992-On	300, 500	B55D23L		
1999-on	800	BDIN53L		
FERRARI				
1965-93	All models	BN50Z	BNS70	
FIAT				
1958-82	100, 124, 125, 127, 128, 130, 131, 132	B46	B57MF	B67MF
1961-70	500, 500D, 600D, 770	B41	B51MF	
1958-82	850, 850S, 855	B46	B57MF	B67MF
1958-82	1100	B46	B57MF	B67MF
1961-70	1100D, 1100E	B41	B51MF	
1958-82	1500, 1800, 2100, 2300	B46	B57MF	B67MF
1983-85	Argenta	B46	B57MF	B67MF
1988-89	Croma	BDIN53L		
1985-89	Regata 85S, 100S	BDIN53L		
1987-89	Regata 100S Strada, Stracki	BDIN53L		
1985-89	Ritmo	BDIN53L		
1981-85	Super Brava MkII, MkIII	B46	B57MF	B67MF
1983-on	Uno	BDIN53L		
1980-83	X1/9 (1.3 & 1.5)	B46	B57MF	B67MF
FORD - 4 cyl.				
1981-89	Bronco	B47	B58MF	B68MF
1960-72	Capri	B43	B53MF	
1989-4/92	Capri	BNS40ZLS	BNS40LMF	
5/92-94	Capri	B55D23L		
1970-74	Capri GT3000 V6, RS3100 V6	B47	B58MF	B68MF
1989-91	Corsair	B47	B58MF	B68MF
1962-74	Cortina 4 Cyl.	B43	B53MF	
1975-82	Cortina 4 Cyl	B47	B58MF	B68MF
1986-95	Courier Crew Cab (Petrol)	B47	B58MF	B68MF
1996-on	Courier Crew Cab (Petrol)	B55D23L	BNS70L	
1999-on	Courier Twin Cab (Petrol)	B55D23R		
1986-on	Courier Crew Cab (Diesel)	BN70Z(13)	BN70Z(15)	BN70ZX
1999-on	Courier Twin Cab (Diesel)	BN70ZL(15)	BN70ZXL	
1998-on	Courier	B57MF	BNS70	
1985-87	Econovan Maxi (Petrol)	BNS40ZLS	BNS40LMF	
1985-87	Econovan Maxi (Diesel)	BN70Z(13)	BN70Z(15)	BN70ZX
1970-75	Escort	B43	B43	
1975-79	Escort	B47	B58MF	B68MF
1991-93	Festiva	BNS40ZLS	BNS40LMF	
1994-on	Festiva, XR4, Trio XR4, GLI,	B55D23L		
1999-on	Festiva Trio, LXi, GLXi	B55D23L		
1999-on	KA	BM96-12		
1981-92	Laser KA-KF	BNS40ZLS	BNS40LMF	
1992-94	Laser KH	B55D23L		
1993-on	Laser KJ, LXI, Liata	B55D23L		
1994-on	Laser, Lynx	BM96-12		
1982-87	Meteor	BNS40ZLS	BNS40LMF	
1995-on	Mondeo 1.2L, 2.0L	BDIN53L		
1991-96	Raider 4x4	BNS70	BN70Z(15)	BN70ZX

MAKE	MODEL	STANDARD Part No.	HEAVY DUTY Part No.	PREMIUM Part No.
FORD - 4 cylinder - continued				
1983-94	Spectron (Petrol)	BNS40ZLS	BNS40LMF	
1983-94	Spectron (Diesel)	BN70Z(13)	BN70Z(15)	BN70ZX
1983-90	Telstar 4 Cyl	BNS40ZLS	BNS40LMF	
1965-74	Transit Vans 4 Cyl	B43	B53MF	
1994-on	Transit Van 2.5 Litre (Petrol & Diesel)	BDIN65L		
FORD - 6 cyl.				
1972-82	Cortina 6 Cyl	B47	B58MF	B68MF
1974-94	F100, F150, F250, F350	B47	B58MF	B68MF
1961-6/91	Fairlane	B47	B58MF	B68MF
6/91-6/94	Fairlane EB, ED	B58EB		
7/94-97	Fairlane NF	B57EF		
1998-on	Fairlane AU	B57EF		
1961-6/91	Falcon / Fairmont	B47	B58MF	B68MF
6/91-6/94	Falcon / Fairmont EB, ED	B58EB		
7/94-on	Falcon / Fairmont EF, EL	B57EF		
1998-on	Falcon / Fairmont AU	B57EF		
1972-6/91	LTD	B58MF	B68MF	
6/91-94	LTD	B58EB		
1994-	LTD DF	B57EF		
1989-93	Maverick (Petrol)	B58MF	BNS70L	
1989-93	Maverick (Diesel)	BN70ZL(15)	BN70ZLX	
1999-on	Mondeo	BDIN53L		
1963-77	Mustang	B47	B58MF	B68MF
1972-74	RS3100 V6	B47	B58MF	B68MF
1991-on	Sierra	BDIN53L	BDIN53L	
1991-on	Telstar, TX5 6 Cyl	B55D23L		
1973-81	Transit Vans 6 Cyl	B47	B58MF	B68MF
1996-on	Transit Van High Roof & low Roof	BDIN53L (x2)		
1999-on	Transit Van	BDIN65L (x2)		
FORD - 8 cyl.				
1961-6/91	Falcon / Fairmont	B47	B58MF	B68MF
6/91-6/94	Fairlane EB, ED	B58EB		
7/94-on	Fairlane NF	B57EF		
1998-on	Fairlane AU	B57EF		
6/91-6/94	Falcon / Fairmont EB, ED	B58EB		
7/94-on	Falcon / Fairmont EF, EL	B57EF		
1998-on	Falcon / Fairmont AU	B57EF		
1972-6/91	LTD, Landau	B58MF	B68MF	
6/91-94	LTD	B58EB		
1994-	LTD DF	B57EF		
1963-77	Mustang	B47	B58MF	B68MF
HOLDEN - 4 cylinder				
1989-92	Apollo	BNS40ZLS	BNS40LMF	
1992-on	Apollo	B55D23L	BNS40LMF	
1984-89	Astra	BNS40ZLS	BNS40LMF	
1996-on	Astra 1.6, 1.8	BDIN53L		
1999-on	Astra	BDIN53L		
1985-94	Barina	BNS40Z	BNS60	
1994-99	Barina	BDIN53L		
1996-99	Barina City, Cabrio	BDIN53L		
1999-on	Barina City, Cabrio, Swing	BM96-12		
1996-on	Combo Van	BDIN53L		
1999-on	Combo Van	BM96-12		
1991-95	Calibra	BDIN53L	BDIN65L	
1984-98	Calais	B57MF	B67MF	
1983-86	Camira SL, SLE	B46	B57MF	B67MF
1983-86	Camira SL, SLX	BNS40ZS	BNS40MF	
1987-89	Camira SL, SLE & SLX	B46	B57MF	B67MF

MAKE	MODEL	STANDARD Part No.	HEAVY DUTY Part No.	PREMIUM Part No.
HOLDEN - 4 cylinder - continued				
1980-98	Commodore	B57MF	B67MF	
1985-87	Drover	BNS40Z	BNS60	
1996-on	Frontera Sport	BDIN53L		
1975-84	Gemini Petrol	B41	B51MF	
1975-84	Gemini Diesel	B58MF	B68MF	
1985-87	Gemini	BNS40Z	BNS60	
1982-92	Jackaroo (Petrol)	B43	B53MF	
1993-on	Jackaroo (Petrol)	BN50Z	BNS70	
1982-on	Jackaroo (Diesel)	BN70Z(13)	BN70Z(15)	BN70ZX
1989-91	Nova	B43	B53MF	
1992-on	Nova	B53MF		
1986-87	Piazza (Turbo)	B47	B58MF	B68MF
1981-87	Rodeo (Petrol)	B41	B51MF	
1988-95	Rodeo (Petrol)	B46	B57MF	B67MF
1996-on	Rodeo (Petrol)	B55D23L	BNS70L	
1981-93	Rodeo (Diesel)	BNS70	BN70Z(15)	BN70ZX
1999-on	Rodeo Space Cab (Diesel)	BN70Z(15)	BN70ZX	
1996-on	Rodeo Twin Cab (Diesel)	BN70Z(15)	BN70ZX	
1983-91	Shuttle (Petrol)	B43	B53MF	
1983-87	Shuttle (Diesel)	BN70Z(13)	BN70Z(15)	BN70ZX
1977-78	Sunbird	B46	B57MF	
1967-74	Torana 4 Cyl	B41	B51MF	
1974-79	Torana 4 Cyl	B46	B57MF	B67MF
1969-79	Torana	B57MF	B67MF	
1998-on	Vectra	BDIN65L		
1999-on	Vectra 2.2L 4 cyl. (Petrol)	BDIN53L		
HOLDEN - 6 cyl.				
1956-61	FE, FC, FB	B46	B57MF	B67MF
1961-65	EK, EJ, EH	B46	B57MF	B67MF
1965-78	HD, HR, HK, HT, HG, HQ, HJ, HX, HZ	B46	B57MF	B67MF
1971-85	Caprice	B46	B57MF	B67MF
1990-on	Caprice	B57MF	B67MF	
1980-98	Commodore	B57MF	B67MF	
1996-97	Commodore		B57EF	
1998-on	Commodore VT	B58VT		
1999-on	Frontera V6	BNS70L		
1999-on	Jackaroo 3.5 V6 (Petrol)	B55D23R		
1999-on	Jackaroo 3.0L Turbo (Diesel)	BN70Z(15)	BN70ZX	
1999-on	Jackaroo SE 3000 Turbo (Diesel)	BNS70		
1998-on	Rodeo V6 (Petrol)	B55D23L	BNS70L	
1999-on	Rodeo 3.2L V6 Twincab (Petrol)	B55D23L	BNS70L	
1990-on	Statesman	B57MF	B67MF	
1999-on	Vectra 2.5L V6	BDIN65L		
HOLDEN - 8 cyl.				
1968-78	HK, HT, HG, HQ, HJ, HX, HZ	B46	B57MF	B67MF
1984-98	Calais	B57MF	B67MF	
1971-85	Caprice	B46	B57MF	B67MF
1990-on	Caprice	B57MF	B67MF	
1980-98	Commodore	B57MF	B67MF	
1996-on	Commodore		B57EF	
1998-on	Commodore VT	B58VT		
1974-79	Sandman	B46	B57MF	B67MF
1969-79	Torana	B57MF	B67MF	
1971-85	Statesman de Ville	B46	B57MF	B67MF
1990-on	Statesman	B57MF	B67MF	
HONDA				
1966-77	All models except below	BNS40Z		
1977-85	Accord, Scamp	BNS40ZLS	BNS40LMF	

MAKE	MODEL	STANDARD Part No.	HEAVY DUTY Part No.	PREMIUM Part No.
HONDA - continued				
1986-92	Accord	BNS60S		
1993-94	Accord	BNS40Z	BNS60	
1994-96	Accord	B55D23L		
1996-97	Accord 4Cyl, Exi	B55D23L	BNS70L	
1998-on	Accord 4 Cyl	BNS60S		
1999-on	Accord 4 Cyl LEV VTiL	B55D23L		
1998-on	Accord 6 Cyl	BNS70		
1999-on	Accord V6	BNS70		
1986-92	City, Scamp	BNS60S		
1973-78	Civic 1500, 1300	BNS40ZLS	BNS40LMF	
1993-on	Civic	BNS40ZS	BNS40MF	
1996-on	Civic	BNS60S		
1999-on	Civic Sedan, & Hatch	BNS60S		
1989-on	Concerto	BNS60S		
1999-on	CR-V Sport	BNS60S		
1989-92	CRX	BNS60S		
1993-on	CRX	BNS40ZS	BNS40MF	
1999-on	HR-V Sport	BNS60LS		
1986-94	Integra 4 Cyl	BNS60S		
1986-96	Integra DOHC	B55D23L	BNS70	
1996-on	Integra	BNS60S		
1986-92	Legend	BN50ZL	BNS70L	
1993-95	Legend	BNS70		
1990-on	NSX V6	BNS40Z	BNS60	
1996-on	Odyssey	B55D23L	BNS70L	
1979-88	Prelude	B41	BNS60S	
1988-90	Prelude	BN50ZL	BNS70L	
1991-97	Prelude	B55D23R	BNS70	
1997-on	Prelude	BNS70L		
1986-92	Scamp	BNS60S		
1999-on	S2000	BNS60LS		
HYUNDAI				
1999-on	Coupe	B68MF		
1986-87	Excel GL, GLS,	BNS40ZS	BNS40MF	
1988-95	Excel GL, GLS, L, LS, GS	B47	B58MF	B68MF
1993-on	Excel S Coupe	B47	B58MF	B68MF
1998-on	Excel Sprint GX, GXL	B58MF	B68MF	
1999-on	Grandeur	B68MF		
1991-94	Lantra	B46	B57MF	B67MF
1995-98	Lantra	B51MF		
1998-on	Lantra SE, GL, GLS	B58MF	B68MF	
1999-on	Levant	BDIN53L	B68MF	
1990-97	S Coupe	B46	B57MF	B67MF
1998-on	S Coupe SX, FX, SFX	B47	B58MF	B68MF
1989-98	Sonata	B46	B57MF	B67MF
1994-on	Sonata GLE	B46	B57MF	B67MF
1999-on	Sonata 4 Cyl	BM96-12		
1999-on	Sonata V6	B68MF		
1984-on	Stellar	B41	B51MF	
JAGUAR				
1956-69	2.4, 3.4, 3.8 Litre, MkVII, MkVIII	BN70Z(13)	BN70Z(15)	BN70ZX
1966-71	420S, 420G	BN70Z(13)	BN70Z(15)	BN70ZX
1966-71	Mk X, Mk XI.	BN70Z(13)	BN70Z(15)	BN70ZX
1962-76	E Type 6 & 12 Cyl	B57MF	B67MF	
1972-87	XJ6 all include Sovereign	B57MF	B67MF	
1987-94	XJ40 (XJS, XJ6) all include Sovereign	BDIN53L		
1994-on	XJ6	DIN85L		
1972-93	XJ6, & V12	B57MF	B67MF	

MAKE	MODEL	STANDARD Part No.	HEAVY DUTY Part No.	PREMIUM Part No.
JAGUAR - continued				
1994-on	XJ12	DIN85L		
1994-on	XJR	DIN85L		
1995-on	Sovereign, XJ300	DIN85L		
JEEP (Chrysler)				
1979-85	Cherokee	B57MF	B67MF	
1994-on	Cherokee Sport	B46	B57MF	B67MF
1997-on	Cherokee			B67MF **
1999-on	Cherokee Sport			B67MF **
1974-85	CJ5, CJ6, CJ8, CJ10, CJ20,	B46	B57MF	B67MF
1994-on	Grand Cherokee, Laredo	B57MF	B67MF	
1999-on	Grand Cherokee V8 (European make)	BDIN65L		
1996-98	Neon	BDIN53R		
1999-on	Neon	BM96-12		
1999-on	Neon Viper	BDIN53R		
1981-85	Renegade	B46	B57MF	67MF
1996-on	Wrangler	BDIN53R		
1999-on	Wrangler **	BDIN53R		
1997-on	Voyager	BDIN53R		
1999-on	Voyager (American Battery)	BDIN53R	B67MF	
1999-on	Voyager (European Battery)	BDIN53R		
KIA				
1999-on	Carnival	BNS70L		
1992-93	Ceres Rocsta	B47	B58MF	B68MF
1995-97	Ceres Diesel	BN70Z(13)	BN70Z(15)	BN70ZX
1998-on	Ceres Diesel	BN70Z(15)	BN70ZX	B86MF
1998-on	Credos	BDIN53R		
1999-on	Credos GLX	BDIN53L		
1997-on	Mentor	BDIN53R		
1999-on	Mentor	BDIN53L		
1996-on	Sportage 4WD	BDIN53R		
LADA				
1990-on	Cevaro GL	B46	B57MF	B67MF
1983-93	Niva, Cabriolet, Toro	B46	B57MF	B67MF
1988-on	Samara (1.3)	B46	B57MF	B67MF
1988-on	Volante (1.3)	B46	B57MF	B67MF
LANCIA				
1974-85	Beta, Beta HPE, Beta 2000	BDIN53L		
1966-75	Flavia, Fulvia	BDIN53L		
1974-85	Gamma	B46	B57MF	B67MF
1986-on	Thelma 2800 V6	BDIN53L		
LANDROVER (Refer also to Rover Section)				
1978-84	Diesel	B86	B86Z	
1984-90	One Ten (Petrol & Diesel)		B57MF (x2)	B67MF (x2)
1977-84	Petrol	BN70Z(13)	BN70Z(15)	BN70ZX
1978-84	Diesel	B86	B86Z	
1992-96	Defender (Diesel)	BN70Z(15)	BN70ZX	
1999-	Defender Series II	B86MF		
2000-on	Defender Extreme	B86MF		
1999-	Discovery Series II 4.0L V8	B86MF		
1991-96	Discovery (Petrol)	BNS70**		
2000-on	Discovery (Petrol)	BNS70**		
1992-96	Discovery (Diesel)	BNS70**		
2000-on	Discovery TD5 (Diesel)	B86MF		
1998-on	Freelander (Petrol)	BDIN53L	BDIN65L	
1998-on	Freelander (Diesel)	BDIN65L		
LEXUS				
1999-on	IS200	B55D23L		
1990-on	ES300	B55D23L	BNS70L	

** Adjustment to clamps may be required

MAKE	MODEL	STANDARD Part No.	HEAVY DUTY Part No.	PREMIUM Part No.
LEXUS - continued				
1999-on	ES300	B55D23L		
1998-on	GS300	BNS70L		
1990-on	LS400	BN70ZL(15)	BN70ZXL	
1999-on	LS400	BNS70L		
1998-on	LX470	BNS70L		
1999-on	LX470 4WD			
LOTUS				
1968-on	Eclat 522, Elan	B43	B53MF	
1968-on	Elite, Esprit 521, Europa	B43	B53MF	
1986-on	Excel	BDIN53L	BDIN53L	
MAZERATI				
1987-on	All models	B57MF	B67MF	
MAZDA				
1977-80	121	BNS40Z		
1987-96	121	BNS40ZLS	BNS40LMF	
1994-on	121	BNS60L	BNS60L	
1996-on	121 Revue	BNS40ZL	BNS60LS	
1996-on	121 Metro	B55D23L		
1999-on	121 Metro	BNS40ZLS	BNS40LMF	
1977-80	323	BNS40Z		
1980-91	323	BNS40ZLS	BNS40LMF	
1994-on	323	B55D23L		
1999-on	323 Astina	B55D23L		
1978-83	626 - 2.0L	BNS40ZS	BNS40MF	
1983-87	626 - 2.0L	BNS40ZL		
1987-95	626 - 2.2L	BNS40ZLS	BNS40LMF	
1994-on	626 - 2.0L, 626 Eclipse	B55D23L		
1999-on	626 - 2.0L	B55D23L		
1994-on	626 - 2.5L	B55D23L		
1984-88	626 (Diesel)	BN50ZL	BNS70L	
1973-82	929 - 1.8L & 2.0L	BNS40ZS	BNS40MF	
1982-87	929 - 2.0L	BNS40ZLS	BNS40LMF	
1991-96	929 - 3.0L	B55D23L		
1993-96	Astina,	B55D23L		
1996-on	Astina V6	B55D23L		
1980-91	B2200 (Petrol)	BNS40ZS	BNS40MF	
1993-on	B2600 Bravo	B57MF	B67MF	
1970-78	Capella	B46	B57MF	B67MF
1970-78	Capella (Rotary Engine)	BN50Z	BNS70	
1978-89	E1300, E1600, E1400	BNS40Z	BNS60	
1980-95	E2000	BNS40ZLS	BNS40LMF	
1980-89	E2200, B2200 (Diesel)	BN70ZL(15)	BN70ZLX	
1999-on	MPV	BNS70L		
1987-91	MX6 4 Cyl & Turbo	BNS40ZLS	BNS40LMF	
1990-on	MX6	B55D23L		
1990-on	MX7	B55D23L		
1993-on	Protege	B55D23L		
1972-80	RX3, RX4, RX5	B55D23L		
1980-95	RX7	B58MF	B55D23L	
1972-78	Savannah 808, 1600	BNS40Z		
1983-89	Travellor	BNS40ZS	BNS40MF	
1998-on	MPV	BNS70L		
MERCEDES BENZ				
1999-on	A Series	BDIN53L		
1994-on	C250, C280	BDIN85L		
1999-00	C Series	BDIN85L		
1999-00	CLK Convertible	BDIN85L		
1996-on	C180	BDIN85L	BDIN95L	

MAKE	MODEL	STANDARD Part No.	HEAVY DUTY Part No.	PREMIUM Part No.
MERCEDES BENZ - continued				
1994-on	E220, E280	BDIN53L	BDIN65L	
1999-on	E Series	BDIN65L		
2000-on	MB100D Van	BDIN65L		
2000-on	ML320 4WD	BDIN85L		
1999-on	S Series	BDIN85L		
1991-on	S320	BDIN85L		
1991-on	S420	BDIN85L		
1990-on	SL500	BDIN85L		
1973-86	S123, S126	BDIN65L		
2000-on	Vito 113 Van	BM96-12		
2000-on	108CDI Van	BDIN65L		
1991-on	180E	BDIN53L	BDIN65L	
1984-93	190E, 190E 2.6	BDIN53L	BDIN65L	
1986-87	190D	BDIN65L	BDIN85L	
1966-on	230, 230E, 230GE, 230SL, 230TE	BDIN65L		
1968-78	250, 250C, 250CE	BDIN65L		
1976-85	240D	BDIN85L		
1976-85	260E	BDIN65L		
1976-85	280, 280C, 280CE, 280E	BDIN65L		
1976-85	280S, 280SE, 280SEL	BDIN65L	BDIN85L	
1976-85	280SL, 280SLC, 280TE	BDIN65L		
1976-85	300D	BDIN85L		
1986-on	300D	BDIN65L	BDIN85L	
1986-on	300E, 300CE	BDIN65L	BDIN85L	
1976-85	300SE	BDIN65L	BDIN85L	
1991-on	300SE	BDIN85L		
1976-85	300SEL	BDIN65L	BDIN85L	
2000-on	312D Sprinter	BDIN85L		
1986-on	320E	BDIN65L	BDIN85L	
1986-on	350SE, 350SEL	BDIN85L		
1986-on	350SL	BDIN65L	BDIN85L	
1986-on	380SEC, 380SEL	BDIN85L		
1986-on	380SL	BDIN65L	BDIN85L	
1991-on	400SE	BDIN85L		
1986-on	420	BDIN85L		
1986-on	450SE, 450SEL	BDIN85L		
1986-on	450SL, 450SLC	BDIN65L	BDIN85L	
1990-on	500SEL, 500SL	BDIN85L		
1986-89	560SL	BDIN65L	BDIN85L	
1986-94	560SEC, 560SEL	BDIN85L		
1993-on	600SEL	BDIN85L		
MG				
1968-73	Midget	B41	B51MF	
1955-76	MGA 1500, 1600	B03 (x2)		
1955-76	MGB 1800	B03 (x2)		
1954-59	Magnette	B46	B57MF	B67MF
1996-98	MGF	BDIN53L		
1999-	MGF 1.8L, 1.8L.VVC	BDIN53L		
MITSUBISHI (including CHRYSLER)				
2000-on	Cantor 1.5	BN100		
2000-on	Cantor 2.0, 3.5	BNS70 (x2)		
2000-on	Cantor 4WD	BNS70 (x2)		
1971-78	Chrysler	BN50ZL	BNS70L	
1981-91	Colt (all models)	BNS40ZLS	BNS40LMF	
1983-89	Cordia	BNS40ZS	BNS40MF	
1998-on	Challenger	BNS70		
1999-on	Challenger V6 4WD	BNS70	BN70Z(15)	BN70ZX
1990-95	Eclipse	BNS40ZS	BNS40MF	

PASSENGER VEHICLES



MAKE	MODEL	STANDARD Part No.	HEAVY DUTY Part No.	PREMIUM Part No.
MITSUBISHI (including CHRYSLER) - continued				
1999-on	Escape V6 4WD	B55D23R		
1979-87	Express L200, L300, Express (SWB) Petrol	BNS40ZS	BNS40MF	
1979-87	Express (Diesel)	BN70Z(15)	BN70ZX	
2000-on	GPX	BNS40Z		
1974-94	Galant (except Hardtop)	B41	B51MF	
1974-80	Galant Hardtop	B41	B51MF	
1994-on	Galant	B46	B57MF	B67MF
1993-on	Galant HG, HH, HT	B55D23L		
1971-88	Lancer	B41	B51MF	
1989-94	Lancer	BNS40ZLS	BNS40LMF	
1994-96	Lancer	BNS40ZS	BNS40MF	
1996-on	Lancer	BNS40ZLS	BNS40LMF	
1985-92	Magna	BNS40ZS	BNS40MF	
1985-91	Magna Elite	B46	B57MF	B67MF
1991-95	Magna Elite V6	B57MF	B67MF	
1991-95	Magna	B46	B57MF	B67MF
1996-on	Magna V6	B57MF	B67MF	
1993-on	Magna	B55D23L		
1998-on	Magna Altera LS	B57MF	B67MF	
1999-on	Magna Advance, Executive, Solara	B57MF	B67MF	
1996-97	Mirage	BNS40ZS	BNS40MF	
1997-on	Mirage	BNS40ZLS	BNS40LMF	
1984-91	Nimbus (Some models take NS40ZS)	BNS40ZLS	BNS40LMF	
1992-on	Nimbus	B41	B51MF	
1999-on	Nimbus	B43	BNS60LS	
2000-on	Nimbus	BNS40ZLS	BNS40LMF	
1983-95	Pajero (Petrol)	BN50Z	BNS70	
1996-on	Pajero V6	BN70Z(15)	BN70ZX	
1999-on	Pajero V6 3500	B55D23R	BNS70	
1999-on	Pajero iO 4 Cyl	B55D23L		
1983-95	Pajero (Diesel)	BNS70	BN70Z(15)	BN70ZX
1978-80	Scorpion	B41	BNS60S	
1980-85	Scorpion	BN50ZL	BNS70L	
1977-79	Sigma 1600/1850	B41	B51MF	
1980-87	Sigma 2000, 2600, 2.6	BN50Z	BNS70	
1980-87	Starion	BN50Z	BNS70	
1986-on	Starwagon 2.0L/2.4L	BNS40ZS	BNS40MF	
1987-92	Triton Cab, Utility	BNS70		
1993-on	Triton Cab (Club & Double), Utility	B55D23L		
1996-on	Triton Dual Cab Utility V6 3.0L	BNS70		
1996-on	Triton Dual Cab Utility 2.8L (Diesel)	BN70Z(15)	BN70ZX	
1999-on	Triton 2.8L (Diesel)	BN70Z(15)	BN70ZX	
1999-on	Triton GL	BNS40ZS	BNS40MF	
1999-00	Triton 3.0L V6	BNS70		
1991-on	Verada	B46	B57MF	B67MF
1971-78	Valiant,	BN50ZL	BNS70L	
NIKI				
1989-94	All Models	BM96-12		
NISSAN				
1970-79	120Y	B41	B51MF	
1972-81	180B, 200B	B46	B57MF	B67MF
1996-on	200SX	B55D23L		
1999-on	200SX	B55D23R		
1971-78	240 & 260 Series	B46	B57MF	B67MF
1978-84	280 Series	B46	B57MF	B67MF
1967-on	300C, 300ZX	BNS70L		
1980-85	720 (Diesel)	BN70Z(13)	BN70Z(15)	BN70ZX
1980-85	720 (Petrol)	B46	B57MF	B67MF



PASSENGER VEHICLES

MAKE	MODEL	STANDARD Part No.	HEAVY DUTY Part No.	PREMIUM Part No.
NISSAN - continued				
1970-79	1200	B41	B51MF	
1967-81	1300, 1600, 1600S	B46	B57MF	B67MF
1967-on	1800, 1900, 2000, 2300, 2400	BN50Z	BNS70	
1981-86	Bluebird	B46	B57MF	B67MF
1986-on	Bluebird V6, SGX, Turbo	BN50Z	BNS70	
1994-on	Bluebird SSS	B55D23L		
1983-87	EXA	BNS40ZLS	BNS40LMF	
1987-on	EXA (Turbo)	B46	B57MF	B67MF
1964-70	Fairlady	B41		
1984-88	Gazelle	BNS40ZLS	BNS40LMF	
1992-on	Infiniti	B55D23L		
1990-on	Maxima	B55D23L		
1999-on	Maxima 30S Touring	B55D23L		
1996-on	Micra	BNS60LS		
1986-94	Navara (Petrol)	B46	B57MF	B67MF
1994-on	Navara (Petrol)	B55D23L		
1996-on	Navara Dual Cab, Ute, (Petrol)	B55D23L		
1999-on	Navara DX 2.4 TwinCab	B55D23R		
1985-94	Navara (Diesel)	BN70Z(13)	BN70Z(15)	BN70ZX
1999-on	Navara DX 3.2 D 4X4	BN70Z(15)	BN70ZX	
1974-80	Nissan E20	BN50Z	BNS70	
1988-93	Nomad, NX Coupe	BNS40ZLS	BNS40LMF	
1974-89	Patrol (Petrol)	BN50Z	BNS70	
1980-88	Patrol (Diesel)	BN70Z(13)	BN70Z(15)	BN70ZX
1989-96	Patrol (Diesel)	BN70ZL(15)	BN70ZXL	
1990-98	Patrol (Petrol)	BNS70L		
1998-on	Patrol Y61 (Petrol)	BNS70L		
1999-on	Patrol (Petrol)	BNS70L	BN70Z(15)	BN70ZX
1998-on	Patrol Y61 (4.2 Diesel)		BN70ZL(15)	BN70ZXL
1998-on	Patrol Y61 (2.8 Turbo Diesel)		BN70ZL(15)	BN70ZXL
1999-on	Patrol Turbo Diesel, DX 4.2		BN70ZL(15)	BN70ZXL
1988-92	Pathfinder	BN50Z	BNS70	
1993-98	Pathfinder V6 Wagon, V6 Twincab	B57MF	B67MF	
1998-on	Pathfinder	B55D23R	BNS70	
1999-on	Pathfinder	B55D23R		
1986-89	Pintara	B46	B57MF	B67MF
1989-93	Pintara	B47	B58MF	B68MF
1983-85	Prairie	BNS40Z	BNS60	
1981-93	Pulsar	BNS40ZLS	BNS40LMF	
1993-94	Pulsar (Imported)	BNS40ZL	BNS40MF	
1994-98	Pulsar Auto	BNS40ZL	BNS60L	
1998-on	Pulsar	BNS40ZLS	BNS40LMF	
1999-on	Pulsar SSS	BNS40ZLS	BNS40LMF	
1978-90	Skyline	B46	B57MF	B67MF
1978-86	Stanza	B46	B57MF	B67MF
1979-86	Sunny 2.0 GL	B41	B51MF	
1993-on	Serena Wagon	BNS70		
1994-on	SX V6 3Ltr	B55D23L		
1979-86	Sylvia 2.0 GL,	B41	B51MF	
1997-on	Terrano (Diesel)	B55D23R	BNS70	B86Z
1999-on	Terrano 2.7 TDI	BNS70		
1997-on	Terrano (Petrol)	B55D23R		
1974-92	Urvan (Petrol)	BN50Z	BNS70	
1980-92	Urvan (Petrol)	BN70Z(13)	BN70Z(15)	BN70ZX
1990-on	Urvan (Diesel)	BN70ZL(15)	BN70ZXL	
1981-93	Vanette	BNS40ZS	BNS40MF	
1986-88	Vector	B46	B57MF	B67MF
1989-on	Vector	BNS40ZLS	BNS40LMF	

MAKE	MODEL	STANDARD Part No.	HEAVY DUTY Part No.	PREMIUM Part No.
PEUGEOT				
1987-93	205	B46	B57MF	B67MF
1993-on	205	BM96-12		
1996-on	306	BM96-12	BDIN53L	
1955-86	403, 404	B46	B57MF	B67MF
1989-93	405	B46	B57MF	B67MF
1995-96	405, 405ml 1.6	BDIN53L		
1996-on	405SRDT	BDIN53L	BDIN65L	
1996-on	406	BDIN53L	BDIN65L	
1955-86	504	B46	B57MF	B67MF
1975-76	504LTI	B41	B51MF	
1979-87	504GLD,	BN70Z(13)	BN70Z(15)	BN70ZX
1955-86	505	B46	B57MF	B67MF
1980-on	505 (Diesel), 505 (Turbo)	BNS70	BN70Z(15)	BN70ZX
1978-81	604GL, 605	B46	B57MF	B67MF
1991-94	205, 405Mi 1.6	BDIN53L		
PORSCHE				
1969-94	911, 911S, 911SC, 911SC (Turbo)	BDIN65L		
1969-94	911E	BM96-12 (x2)		
1968-73	911T	BDIN53L (x2)		
1977-82	924	BDIN53L		
1980-92	928, 928S	BDIN65L	BDIN85L	
1987-88	928S4	BDIN65L		
1983-94	944, 944S	BDIN53L		
1992-on	968	BDIN53L		
PROTON				
1994-95	Proton	BDIN53R		
1996-on	Proton	B57MF	B67MF	
1987-89	Saga	BNS40ZS	BNS40MF	
1997-98	Satria	B46	B57MF	B67MF
1999-on	Satria	B55D23R		
1997-on	M21 Coupe	B46	B57MF	B67MF
1996-98	Persona	B46	B57MF	B67MF
1999-on	Persona	B55D23R		
1994-on	Wira	BDIN53R		
RENAULT				
1977-83	14 VIRAGE	B43	B53MF	
1968-77	16, 16TL, 16TS	B43	B53MF	
1973-80	17TL/17TS	B43	B53MF	
1980-84	18 ,18GTS	BDIN53L		
1993-94	19	BDIN53L		
1996-on	19	BM96-12		
1992-94	19RT, 19TXE	B47	B58MF	B68MF
1979-84	20TS	B47	B58MF	B68MF
1985-89	21TSE, 21TXE, 25GTV	B46	B57MF	B67MF
1982-87	Fuego GTX	B46	B57MF	B67MF
ROLLS ROYCE				
1955-86	All Models	BN70Z(13)	BN70Z(15)	BN70ZX
1986-on	All Models	BN50Z	BNS70	
ROVER (Refer also to Land Rover)				
1965-91	2000, 2000TC	B46	B57MF	B67MF
1968-79	3.5L, 3500, 3500S	BN70Z(15)	BN70ZX	
1986-87	416i	B41	B51MF	
1987-92	416i	B47	B58MF	B68MF
1988-91	825/827	B47	B58MF	B68MF
1983-86	Quintet	B43	BNS60LS	
1974-83	Range Rover (Petrol)	BN70Z(13)	BN70Z(15)	BN70ZX
1984-95	Range Rover (Petrol)	BN50Z	BNS70	
1990-93	Range Rover (Diesel)	BN50Z (x2)	BNS70 (x2)	

MAKE	MODEL	STANDARD Part No.	HEAVY DUTY Part No.	PREMIUM Part No.
ROVER (Refer also to Land Rover)				
1994-on	Range Rover	BN50Z	BNS70	
1995-on	Range Rover	BN70Z(15)	BN70ZX	
1996-on	Range Rover 4.0L, 4.6L	B86MF **		
1999	Range Rover	B86MF		
2000-on	Range Rover	BN70Z(15)	BN70ZX	
1996-on	Rover 416i Vitesse	BNS60S		
1979-85	SDI-3500SE	BN50Z	BNS70	
1983-85	Series 2 SE	B46	B57MF	B67MF
1979-85	Vanden Plas	BN50Z	BNS70	
SAAB				
1997-on	93	BDIN53L		
1998-on	95, Convertible	BDIN65L		
1973-95	All Models	BN50ZL	BNS70L	
1994-on	900, 900 2.0L, 900 V6, 900S-SL	BDIN53L	BDIN65L	
1994-on	9000	BDIN53L	BDIN65L	
1995-on	9000 V6	B57MF	B67MF	
1996-on	9000	BDIN53L		
1994-on	2.5 V6	BDIN53L		
SANGYONG				
1996-on	Musso 4WD (Petrol & Diesel)	BN70Z(13)	BN70Z(15)	BN70ZX
1998-on	Korando 4WD (Petrol)	B57MF	B67MF	
SEAT				
1994-on	Ibitza	BDIN53L		
1994-on	Cordoba, Toledo	BDIN65L		
SUBARU				
1973-91	All Models (Except Sherpa)	BNS40Z		
1983-94	Brumby	BNS40Z	BNS60	
1983-94	DL 4WD	BNS40Z	BNS60	
1989-92	Fiori	BNS40Z		
1999-on	Forrester Limited, GT	B55D23L		
1999-on	Heritage	BNS40Z		
1994-on	Impreza WRX	BNS60L		
1996-on	Impreza GX	BNS60L		
1996-on	Impreza GX	B55D23L		
1999-on	Impreza RX	BNS40Z		
1986-95	Leone	BNS40ZL	BNS60L	
1996-on	Liberty GX, LX, RX 2.5	BNS60L		
1995-97	Liberty RS Turbo	BNS40ZL	BNS60L	
1999-on	Liberty RX 2.5	BNS40Z		
1996-on	Liberty Sportswagon	BNS60L		
1996-on	Outback 4WD	BNS60L		
1999-on	Outback	BNS40Z		
1987-93	Sherpa	BNS40ZL	BNS60L	
1992-95	SVX	B47	B58MF	B68MF
1987-93	Vortex	BNS40ZL	BNS60L	
SUZUKI				
1971-82	LJ50, LJ80, LJ81 4WD	BNS40Z		
1999-on	Jimny	BNS40ZS	BNS40MF	
1995-on	Baleno	BNS40ZL		
1996-on	Baleno 1.6L, 1.8L	BNS60L		
1999-on	Baleno	BNS60L		
1986-93	Sierra	BNS40Z		
1996-on	Sierra 1.3L	BNS40Z	BNS60	
1986-93	Swift	BNS40Z		
1996-on	Swift 1.6L	BNS40Z	BNS60	
1986-93	Vitara	BNS40Z		
1994-on	Vitara	BNS40ZL	BNS60L	
1996-on	Vitara 1.6L	BNS40ZL	BNS60L	

** Adjustment to clamps may be required

PASSENGER VEHICLES



MAKE	MODEL	STANDARD Part No.	HEAVY DUTY Part No.	PREMIUM Part No.
SUZUKI - continued				
1996-on	Vitara 2.0L, V6	BNS60		
1998-on	Vitara Wagon R	BNS60L		
1999-on	Vitara Grang V6	B55D23L	BNS70L	
1996-on	X90 1.6L	BNS40ZL	BNS60L	
TOYOTA				
1985-87	Avante	BNS40ZLS	BNS40LMF	
1985-91	Bundera 2.6L	BN50Z	BNS70	
1985-91	Bundera (Diesel)	BN70Z(13)	BN70Z(15)	BN70ZX
1983-87	Camry GLi	BNS40ZLS	BNS40LMF	
1993-on	Camry SDV10 / VDV10	B55D23L		
1987-92	Camry SV20	BNS40ZLS	BNS40LMF	
1990-92	Camry (4 Cyl)	BNS40ZLS	BNS40LMF	
1988-on	Camry VZV21 6Cyl,	B55D23L		
1999-on	Camry Conquest	B55D23L		
1972-91	Celica ST184 (to 8/91)	B43	BNS60LS	
1990-on	Celica GT4 TURBO 4WD	BN70Z(15)	BN70ZX	
1991-on	Celica ST184 (8/91 on), ST185	B55D23L		
1989-on	Celica SX	BNS40ZLS	BNS40LMF	
1999-on	Celica SX	BNS60S		
1974-82	Corolla	B43	B53MF	
1983-89	Corolla 1300, CS, CS-X, S, SE, XX	BNS40ZLS	BNS40LMF	
1990-on	Corolla AE90, AE93, AE95	BNS40ZLS	BNS40LMF	
1990-on	Corolla AE92, AE94, AE96, AE101, AE102	B53MF		
1999-00	Corolla Ascent, Conquest, Levin	BNS40ZL		
1972-83	Corona	B43	B53MF	
1984-87	Corona	BNS40ZLS	BNS40LMF	
1971-83	Crown	BN50Z	BNS70	
1983-88	Crown Royal	BN50ZL	BNS70L	
1977-82	Cressida	B43	BNS60LS	
1983-94	Cressida	B55D23L		
1999-on	Echo	BNS40ZLS	BNS40LMF	
1987-92	4 Runner YN60/63 (Petrol)	BNS70		
1984-93	4 Runner (Petrol / Diesel)	BNS70		
	Hi-Ace; Lite-Ace; Hilux	BNS40ZS	BNS40MF	
1989-on	Hi-Ace LH103; 113 Auto (Diesel)	BN70Z(15)	BN70ZX	
	Hi-Ace LH103; 125 Manual (Diesel)	BN70Z(13)	BN70Z(15)	BN70ZX
	Hi-Lux (Diesel); Lite-Ace CM36	BNS70	BN70Z(15)	BN70ZX
	Hi-Lux RN85; RN105; 106; 110	BN50Z	BNS70	
	Hi-Lux LN85; 86 Man Trans; LN106; 111; 130	BNS70	BN70Z(15)	BN70ZX
	Hi-Lux RN 130; VZN 130	B55D23L		
	Hi-Lux LN85; 86 Auto Trans	BN70Z(15)	BN70ZX	
	Hi-Ace RZH103; 113; 125 (Petrol)	B57MF		
1998-on	Hilux	B55D23L		
1999-on	HiLux 2.7L	B55D23L		
1999-on	HiLux 3.0L (Diesel)	BN70Z(15)	BN70ZX	
1999-on	Hino FB, FC, FD, FF, FG, FM	B55D23R (x2)		
1999-on	Hino GD, GH	B55D23R (x2)		
1999-on	Hino FS	BN150 (x2)		
1987-90	Landcruiser (Petrol)	BN50Z	BNS70	
1989-on	Landcruiser HZJ70, PZJ70 (Diesel)	BN70Z(13)	BN70Z(15)	BN70ZX
1989-on	Landcruiser FJ70, FJ80, FZJ75 (Petrol)	BN70Z(13)	BN70Z(15)	BN70ZX
1990-on	Landcruiser HDJ80, HZJ80, FZJ80	BN70ZL(15)	BN70ZXL	
1990-on	Landcruiser RJ70, FZJ 105	B55D23L	BNS70L	
1998-on	Landcruiser 100 series (Petrol)	BNS70L		
1998-on	Landcruiser 100 series (Diesel)	BN70ZL(15)	BN70ZX	
1999-on	Landcruiser GXL (Petrol)	BNS70L		
1999-on	Landcruiser 4.2 Troop Carrier (Diesel)	BNS70		
1989-on	Lexcen VN, VP, VR	B57MF	B67MF	

BOSCH



PASSENGER VEHICLES

MAKE	MODEL	STANDARD Part No.	HEAVY DUTY Part No.	PREMIUM Part No.
TOYOTA - continued				
1983-on	NXR Coupe	BNS40ZLS	BNS40LMF	
1983-on	Paseo EL44R	B57MF	B67MF	
1999-on	Paseo	B55D23R		
1996-on	Prado 4 cyl & V6	B55D23L		
1999-00	Prado V6	B55D23L	BNS70L	
2000-on	Prado 3000 Turbo (Diesel)	BN70Z(15)	BN70ZX	
1995-98	RAV4	BNS40ZLS	BNS40LMF	
1998-99	RAV4	BNS60S	B55D23R	
1999-on	RAV4	BNS40ZS	BNS40MF	
1985-89	Seca AE82	BNS40ZLS	BNS40LMF	
1989-on	Seca AE92, AE94, AE96, AE101, AE102	B53MF		
1996-on	Starlet	BNS40ZS	BNS40MF	
1996-on	Starlet	BNS60S		
1983-on	Supra MA70	B55D23L	BNS70L	
8/88-on	Supra Turbo MA70	BN70Z(15)	BN70ZX	
8/88-on	Supra MA70 (no Turbo)	B55D23L		
1983-on	T18 SE DeLuxe	BNS40ZS	BNS40MF	
1983-90	Tarago Petrol	BNS40ZS	BNS40MF	
1990-on	Tarago 4WD TCR10, TCR11, TCR20, TCR21 (Petrol)	B55D23L		
1985-90	Tarago 4WD (Diesel)	BN50Z	BNS70	
1983-88	Tercel SR5	B41	BNS60S	
1992-on	Townace YR39	B57MF	B67MF	
1987-93	Ultima	BNS40ZLS	BNS40LMF	
1993-on	Ultima	B55D23L	BNS70	
1993-on	Vienta	B55D23L	BNS70L	
TRIUMPH				
1964-78	2000, 2500S, 2500TC	B41	B51MF	
1964-78	Dolomite, Sprint	B41	B51MF	
1959-82	Herald (All Models)	B46	B57MF	B67MF
1959-82	Stag & TR2, TR3, TR4, TR4A, TR5, TR6, TR7	B46	B57MF	B67MF
1959-82	Spitfire (All Models)	B46	B57MF	B67MF
VOLKSWAGON				
1969-70	All Models (12 Volt) to August 1969	B41	B51MF	
1970-83	All Models (12 Volt) from August 1970	BDIN53L		
2000-on	Beetle	BM96-12		
1982-91	Caravelle	BDIN53L		
1998-99	Caravelle	BDIN65L		
2000-on	Caravelle	BDIN53L		
1975-82	Golf (Petrol)	BDIN53L		
1990-94	Golf (Petrol)	BDIN65L		
1994-on	Golf (Petrol)	BDIN53L		
1996-on	Golf (Petrol), includes Cabriolet, Vento	BDIN53L		
1978-82	Golf (Diesel)	BDIN53L	BDIN65L	
1974-87	Kombi, Micro Bus	B46	B57MF	B67MF
1975-83	Passat (Petrol)	BDIN53L		
1974-82	Passat (Diesel)	BDIN53L	BDIN65L	
1998-on	Passat	BDIN53L	BDIN65L	
1998-on	Polo	BDIN53L		
1995-on	Transporter	BDIN53L	BDIN65L	
2000-on	Transporter 2.0L (Petrol)	BDIN53L		
2000-on	Transporter 2.5L (Diesel) LWB	BDIN65L		
VOLVO				
1967-75	142, 144, 145 Series	BN50Z	BNS70	
1967-75	164 Series	BN50Z	BNS70	
1975-86	240, 242, 244, 245 Series	BN50Z	BNS70	
1986-91	240, 242, 244, 245 Series	BDIN65L		
1975-86	260, 262, 264, 265 Series	BDIN53R		
1984-87	360 Series	BDIN53L		

PASSENGER VEHICLES



MAKE	MODEL	STANDARD Part No.	HEAVY DUTY Part No.	PREMIUM Part No.
VOLVO - continued				
1993-94	440 Series	BDIN53L		
1983-91	740 Series	BDIN53L	BDIN65L	
1983-90	760 Series	BDIN65L		
1992-on	850 Series	BDIN53L	BDIN65L	
1991-96	940 Series	BDIN53L	BDIN65L	
1991-95	960 Series	BDIN65L		
1996-on	960 Series	BDIN53L		
1996-	S40, V40	BDIN53L		
1999-on	4 Series (includes S40 & V40 models)	BDIN53L		
1999-on	7 Series (includes S70 & V70 models)	BDIN53L		
1999-on	8 Series (includes S80 & V80 models)			
1996-	V70, S70, S90	BDIN65L		



TRUCKS & LIGHT COMMERCIALS

MAKE	MODEL	QTY.	HEAVY DUTY	EXTRA HEAVY DUTY
ALBION				
	All Models except below	2	BN70Z(15)	BN70ZX
	MLH3, FT25A, 27A, M5 & MR7	2	B12A	
ATKINSON				
1979	F3870, K3870	4	B26	
1982	F4870	4	BN70Z(15)	BN70ZX
1977	MK3, T304, T386	4	B26	
BEDFORD				
	Bedford/Isuzu	2	BN150	
	CAL Van Series, CF250	1	B47	B58MF
	CFS, CFL Series, HRE, HAV, Handivan	1	B46	B57MF
	D1,D3,D5 Series	1	BN70Z(15)	BN70ZX
	KGLC3, KGM3, KGT3	1	BN70Z(15)	BN70ZX
	MJR(2BCO), (M1120)	1	B86	B86Z
	MK65(MLR), TK Diesel, TL, TM	2	B89	
	TJ3, TK3, RLH, C3, S3	1	BNS70	
CANTOR (Refer Mitsubishi)				
D.A.F.				
	2300, 2800, 3300, 3600, FTT3300, FT2426, 2526	2	BN150	
DAIHATSU				
1977-on	Delta Series Petrol	1	BNS40Z	BNS60
1978-on	Delta V Series Twin Cab	1	BNS40ZL	BNS60L
1978-on	Delta V Series Diesel	2	B46	B57MF
1986-on	Delta 300	1	BN100	
1979-84	F20JVN, JKBN, F25PN, F60JV, JKB, F65P	1	B86	B86Z
1977-on	F50, F55L, F55P, V24T	1	B87	
1983-90	Handivan	1	BNS40ZL	
1981-90	HijET Vans, 1000 Van	1	BNS40ZLS	BNS40LMF
1984-on	Rocky Petrol	1	BNS40Z	BNS60
1984-on	Rocky Diesel	1	BN100	
1977-on	SV40 Cab Van, SV60C, S60T, F20, 1600cc 4WD	1	BNS40Z	BNS60
1972-on	V12H, V12W, V12HU, V48HU	2	B57MF	B67MF
1985-on	V57HS, V57plus, V58L	1	B87	
1985-on	V76HU, V79HY, V79WY, V78HY	1	B89	
DODGE				
	All Petrol Models	1	BN70Z(15)	BN70ZX
	Cantor - Petrol	1	BN50Z	BNS70
	Cantor - Diesel	1	BN120	
	D3F Diesel	2	B26	
	D3F,D5N, 6 & 8 Cyl. Petrol	1	B57MF	B67MF
	D5N 6Cyl Diesel	1	BN70Z(15)	BN70ZX
	D5N 8Cyl. Diesel	2	B86	B86Z
	215,245 Utility	1	BN50ZL	BNS70L
FORD				
	Bronco	1	B58MF	B68MF
	Cargo 0812, 1515, 1313	1	B89	
	Cargo 2417, 1621, 2421	2	B89	
1978-93	Courier Petrol	1	BNS40Z	BNS60
1999-on	Courier TwinCab Petrol	1	B55D23R	BNS70
1978-93	Courier Diesel	1	BN70Z(15)	BN70ZX
1999-on	Courier Diesel	1	BN70Z(15)	BN70ZX
	D Series all petrol	1	B58MF	B68MF
	D Series all diesel	1	B89	
1984-93	Econovan Petrol	1	BNS40Z	BNS60
1984-93	Econovan Diesel	1	BN70Z(15)	BN70ZX
1967-93	F100, F150, F250, F350, F500, F600, F700, F750	1	B58MF	B68MF
	F800	1	BN70Z(15)	BN70ZX
1967-91	Falcon Ute (Except EB, EF)	1	B47	B58MF
	Falcon Ute EB	1	B58EB	

MAKE	MODEL	QTY.	HEAVY DUTY	EXTRA HEAVY DUTY
FORD - continued				
	Falcon Ute EF	1	B57EF	
	LN700, LN900	1	BN70Z(15)	BN70ZX
	Louisville LN7000, LN8000	1	BN200	
	LN9000, LNT9000, LTL9000	2	BN200	
	Louisville 9000, LNT8000	4	BN70Z(15)	BN70ZX
6 / 93-on	Louisville	2	BN70Z(15)	BN70ZX
	LTS Models	4	B26	
	Trader 4 Cyl Diesel 12V	1	BN120	
	Trader 6 Cyl Diesel 24V.	2	BNS70	BN70Z(15)
1996-on	Trader 0409 Diesel	2	BN50Z	BNS70
1973-81	Transit Vans 6 Cyl	1	B47	B58MF
1965-74	Transit Vans 4 Cyl	1	B43	B53MF
1994-on	Transit Van 2.5 Litre Diesel		BDIN53L	
1995-on	Transit Van Petrol (24 Volt)	2	BDIN53L	
FREIGHTLINER				
1997-on		2	BN150	
FUSO (refer Mitsubishi)				
HINO				
	BX340E	4	B12A	
	AC, BXN, FS270, GS221, RK, RR	2	BN120	
	GD, FC, FG, FD, KL, KL300, KL300E	2	BN50Z	BNS70
1999-on	FB, FC, FD, FF, FG, FM	2	B55D23R	BNS70
1999-on	FS	2	BN150	
1999-on	GD, GH	2	BN50Z	BNS70
	KL300, KL300E, KR360, KR360E, LB500, LB560	2	BN70Z(15)	BN70ZX
HOLDEN				
	Commodore Ute	1	B57MF	B67MF
1985-87	Drover	1	BNS40Z	BNS60
1983-85	Kingswood Ute	1	B46	B57MF
1981-91	Rodeo Petrol	1	B41	B51MF
1999-on	Rodeo 3.2 V6 Twincab Petrol	1	B55D23L	BNS70L
1981-91	Rodeo Diesel	1	BN70Z(15)	BN70ZX
1985-87	Scurry		BNS40Z	BNS60
1983-91	Shuttle Petrol	1	B43	B53MF
1983-87	Shuttle Diesel	1	BN70Z(15)	BN70ZX
HONDA				
	City	1	BNS40ZLS	BNS40LMF
	City Pro-T	1	B43	B53MF
INTERNATIONAL				
	ACCO 1630, 1650, 1810D	2	B47	B58MF
	ACCO 1950D	4	B12A	
	ACCO 2250	3	BN70Z(15)	BN70ZX
	ACCO 1830, DDC0405, CDOF405	4	B26	
	ACCO All Models 1850 TO 2650, 2670	2 TO 4	BN70Z(15)	BN70ZX
	ACC0-A Cummins Engine, 3072 Eagle	4	BN70Z(15)	BN70ZX
	N1630, N1650	2	BN70Z(15)	BN70ZX
	S Line 2670,T Line, TF Line,	3 OR 4	BN70Z(15)	BN70ZX
	Scout, Terra, Traveller, Traveltop	1	B57MF	B67MF
	TF Line	4	BN70Z(15)	BN70ZX
	TK Line	3	BN70Z(15)	BN70ZX
ISUZU				
	CVR162TR, CXG166TR, CXY165	1	BN150	
	CXH16V	2	BN150	
	FUR12N, FUR11N, FS650,450,500, FSR12HRA	1	BN50Z	BNS70
	FUM1400, FUZ1400, FSS500, FTR800, FTR11LTA	1	BN50Z	BNS70
	FUR900, FST500	1	BN50Z	BNS70
	FTS700, FZV, NRP	2	BN50Z	BNS70
	JCR360, 420, 500	2	BN50Z	BNS70

MAKE	MODEL	QTY.	HEAVY DUTY	EXTRA HEAVY DUTY
ISUZU - continued				
	JCS420, SCR370, 480, 480B, TSD45, TWD45	2	BN50Z	BNS70
	NKR150, 200, 250, NPR200, 300, 400	2	BN50Z	BNS70
	SBR372, 422	2	BN50Z	BNS70
KIA				
1992-93	Ceres Rocksta	1	B47	B58MF
1995-on	Ceres Diesel	1	BN70Z(13)	BN70Z(15)
1998-on	Ceres Diesel	1	BN70Z(13)	BN70Z(15)
1999-on	Ceres Diesel	1	BN70Z(13)	BN70Z(15)
KENWORTH				
	All Models inc. C500, K120, K140, L700, W900	4	B26	
	L170	2	B86	B86Z
	T600, T650, C500T, K100E, T600A, T400A	4	BN70Z(15)	BN70ZX
	T400,T450, L700A	3	B86	B86Z
	All Other Models	4	BN70Z(15)	BN70ZX
LEYLAND				
	Buffalo, Comet, Mastiff	2	BN70Z(15)	BN70ZX
	Marathon	2	B89	
M.A.N.				
1968-on	All Models	2	B94	
-1968	10.136FCA	2	BN150	
	15.168NCA, 16.192NCA	2	BN150	
	26.321NC, 26.342FC	2	BN150	
	30.321FCTS, 33.321FCTS	2	BN150	
	E2700, E1400	1	B46	B57MF
	Tilt cab Forward control	1	BN70Z(15)	BN70ZX
MACK				
	A to L Series (Diesel)	4	B26	
	A to L Series (Petrol & Air Start)	2	B12A	
	Buses PR100-2, PR180-2	4	B26	
	B61 Battery Start	2	B12A	
	CLR,CHR Air Start	1	B86T	
	Air Start (24Volt)	2	B86T	
	CHR Elec Start	4	B12A	
	G260 Magnum	2	BN70Z(15)	BN70ZX
	ML Battery Start	2	B86T	
	MH613R, MH6142R	2	B12A	
	688RST, R722VL	2	B12A	
	R Series	2	B12A	
MAZDA				
	B1600, B2200	1	BN50Z	BNS70
	B2000, E1800	1	BNS40Z	BNS60
	B1800	1	BNS40ZLS	BNS40LMF
	B2000, E1600	1	BNS40ZS	BNS40MF
	B2200, B2200 Bus	1	BN70Z(15)	BN70ZX
	E2000, E2200, E2600, E2700, T2000	1	BN50Z	BNS70
	E2700, E3000	1	BN120	
	E2500, E3800, T4000	2	BN50Z	BNS70
	T3000, T3000 Bus, T3500, T3500 Bus	1	BN120	
	T4100	2	BN70Z(15)	BN70ZX
MERCEDES BENZ				
2000-	108CDI Van	1	BNS70	
	1413, 1418, 1918, 1924, 2620, 2624	2	BDIN85L	
	1217, 1419, 1625, 1626, 2219, 2222, 2226	2	BN150	
	2233, 2224	2	BDIN85L	
	1422, 1424	2	BN150	
	2228, 2232, 2233, 2236, 2632	2	BN150	
	2244 30H, 2235K32, 3850A, FL 112	2	BN120	
	2244 30HH	2	BN200	

MAKE	MODEL	QTY.	HEAVY DUTY	EXTRA HEAVY DUTY
MERCEDES BENZ - continued				
	230GE	1	BDIN65L	
	300GD	1	BDIN85L	
2000-	312D Sprinter	1	BDIN85L	
	508LD, D305	2	B86	B86Z
	L911B/48, L911B/42, 1417C/48	2	B47	B58MF
	LA911B, 1217	2	B47	B58MF
	LK, 2624/36, V Series 1425, 2223, 2236	4	B47	B58MF
2000-	MB100D Van	1	BN70ZL(15)	BN70ZXL
	V Series 2238, 2638	4	B47	B58MF
2000-	Vito 113 Van	1	BM96-12	
MITSUBISHI				
	Canter (Petrol)	1	BN50Z	BNS70
	Canter (Diesel)	2	BN50Z	BNS70
	Cantor 1.5	1	BN100	
	Cantor 4WD	2	BNS70	
	D50	1	B41	B51MF
	Express (Petrol)	1	BNS40Z	BNS60
	Express (Diesel)	1	BN70Z(15)	BN70ZX
	FE	2	B57MF	B67MF
	FP, FB, FX, FC, FE, FK, FM, FV Series	2	BN50Z	BNS70
	FN358	2	BN120	
	FU, FP, FS Series	2	BN150	
	Fuso FP-FV 103	1	BN150	
	Fuso FP-FV 113	2	BN150	
	FM104, 215	2	B86	B86Z
	FK102, T653	2	BN50Z	BNS70
	Triton Petrol	1	BNS40ZS	BNS40MF
1999-on	Triton Gl	1	BNS40ZS	BNS40MF
1999-on	Triton 3.0L V6	1	BNS70	
	Triton Diesel Dual Cab	1	BNS70	
	Triton Diesel, 2.8L Diesel	1	BN70Z(15)	BN70ZX
NISSAN (DATSUN)				
	120, 240 2Tonne, 620 1Tonne, 720, E20	1	BN50Z	BNS70
	B120	1	B41	B51MF
	CK10, 30, CW40, L.I.D., CW50, TW50	2	BN150	
	Cab Star Diesel	1	BN100	
	Cab Star Petrol, Cab All 1 & 2 Tonne	1	BN50Z	BNS70
	CMA81F, CMA86F	2	BN50Z	BNS70
	CMA87, CPC Series	2	B51MF	
	CGA, CKA, CLG, CMA, CMF87, CPB	2	BN120	
	CM90, CV Series	2	BN70Z(15)	BN70ZX
	CM Series except CM90	2	BN50Z	BNS70
	Civilian Bus	1	BNS70	
1999-on	Navara DX 2.4 Twincab (Petrol)	1	B55D23R	BNS70
1999-on	Navara 4 x 4 DX 3.2 (Diesel)	1	BN70Z(15)	BN70ZX
	Nomad	1	BNS40ZS	BNS40MF
	UD Series (Diesel), CV, CW, CWA, TW	2	BN120	
	UD LK235 & MK235 Intercooler, KA220 Turbo	2	B55D23R	BNS70
	Urvan (Petrol)	1	BN50Z	BNS70
	Urvan (Diesel)	1	BN70Z(15)	BN70ZX
	Vanette	1	BNS40ZS	BNS40MF
SAAB SCANIA				
	All Models 6 cyl.	2	BN120	
	All Models 8 cyl.	2	BN150	
SUZUKI				
	LJ50, JL50V, L60V, L61, LJ80V	1	BNS40Z	BNS60
	LJ81K, ST10V, 20V, 80V	1	BNS40Z	BNS60
	Hatch, Mighty Boy, Super Carry	1	BNS40Z	BNS60

MAKE	MODEL	QTY.	HEAVY DUTY	EXTRA HEAVY DUTY
STERLING				
	1999-on	4	BN70Z(15)	BN70ZX
TATA				
1996-on	Telcoline 2.0L Diesel 1 tonne ute	1	BN70Z(15)	BN70ZX
TOYOTA				
	Bundera Diesel, Commuter Bus	1	BN70ZL(15)	BN70ZXL
	BJ40, HJ45 Diesel, KL300A, KL300B	1	BN50Z	BNS70
	Coaster Bus BB21, HB30, HZB30, BB40	1	BN50Z	BNS70
	Coaster Bus HZB50	1	B55D23R	BNS70
	DA115	2	BDIN85L	
	DA115 6000 Series	2	BN50Z	BNS70
	Dyna 100, 150	1	BN50Z	BNS70
	Dyna 100 Man. Trans., LY60 (Diesel)	1	BN70Z(15)	BN70ZX
	Dyna 100 Auto Trans. (Diesel)	1	BN70Z(15)	BN70ZX
	Dyna 200 BU60, 400 BU66	1	BN70Z(15)	BN70ZX
	Dyna 300(BU61), 400(BU88, BU91)	1	BN100	
	Dyna 400 BU65	1	BN70Z(15)	BN70ZX
	Dyna 400 YU62	1	B55D23L	BNS70L
	Dyna H1/15, SV15, 21, 2 TON (Diesel)	1	B86	B86Z
	Dyna RU10, 12, 15, 19	1	BNS40Z	
	Dyna RU20	1	B51MF	
	FA115, FA954	1	B57MF	B67MF
	FD Econo (Diesel)	2	B57MF	B67MF
	FD 176	1	B86Z	
	FJ40, FJ40V, FJ45PB, FJ45PB3, FK45V, FJ55V	1	B57MF	B67MF
1987-92	4 Runner YN60, 63 (Petrol)	1	BNS40ZS	BNS40MF
1984-93	4 Runner LN60, 61, 130 (Diesel)	1	BNS70	BN70Z(15)
	Hi-Ace, Lite Ace, HiLux	1	BNS40ZS	BNS40MF
	Hi-Ace RZH103, B113, 125 (Petrol)	1	B57MF	B67MF
	Hi-Ace LH103, 113, 125, Manual Trans (Diesel)	1	BN70Z(15)	BN70ZX
1989-on	Hi-Ace LH103,113, Auto Trans (Diesel)	1	BN70Z(15)	BN70ZX
	HiLux, Liteace CM36 (Diesel)	1	BNS70	
	HiLux YN85,	1	BNS40Z	
	HiLux N85, 90, N105, 106, 110,	1	BN50Z	BNS70
	HiLux LN85, 86 Man. Trans, LN106, 111, 130	1	BNS70	
	HiLux N130, VZN130,	1	B55D23L	BNS70L
	HiLux LN85, 86 Auto Trans.	1	BN70Z(15)	BN70ZX
1996-97	HiLux (Diesel)	1	BNS70	BN70Z(15)
1998-on	HiLux	1	B55D23L	BNS70L
1999-on	HiLux 2.7L	1	B55D23L	BNS70L
1999-on	HiLux 3.0L (Diesel)	1	BN70Z(15)	BN70ZX
1987-on	Land Cruiser (Petrol)	1	BN50Z	BNS70
1989-on	Land Cruiser (2 Door) (Diesel)	1	BN70Z(15)	BN70ZX
1990-on	Land Cruiser FJ70, FJ80, FZJ75 (Diesel)	1	BN70Z(15)	BN70ZX
1990-on	Land Cruiser HZJ70, HZJ80, PZJ70 (Diesel)	1	BN70Z(15)	BN70ZX
1990-on	Land Cruiser HDJ80, HZJ80, FZJ80	1	BN70ZL(15)	BN70ZXL
1990-on	Land Cruiser RJ70	1	BN50Z	BNS70
1998-on	Land Cruiser 100 series (Petrol)	1	BNS70L	
1998-on	Land Cruiser 100 series (Diesel)	1	BN70ZL(15)	BN70ZXL
	Spacia YR22, Tarago TCR10, 20	1	B55D23L	BNS70
	Townace YR39	1	B57MF	B67MF
	6000 Series (Diesel)	2	BN150	
VOLVO				
	B6FO Bus	2	B89	
	B10M	2	BN200	
	F71, F7T, 10, 12C304	4	B46	B57MF
	F10, F12, N10, N12	2	BN150	
	F717, F1017, F1023 TURBO 6, E724	4	B46	B57MF
	F10, F12, FL7F, FL10, N12	4	B46	B57MF

MAKE	MODEL	QTY.	HEAVY DUTY	EXTRA HEAVY DUTY
VOLVO - continued				
	F12, FL7FD	2	BN70Z(15)	BN70ZX
	F12FK, F12F, F12GT	2	B86	B86Z
	F16F	2	B57MF	B67MF
	F86/28	2	B86	B86Z
	F101	4	B12A	
	G88, G89,	2	BN150	
	N7, N10T, N10F, N12F, N12T, N715	2	B86	B86Z
	TAMD40	2	BN150	
WESTERN STAR				
	Early Models	4	B26	
	Late Models	4	BN70Z(15)	BN70ZX
	Late Models	2	BN150	
1994-on	Late Models	3	B86MF	
1999-on	Late Models	3	B86MF	

MAKE	MODEL	QTY.	HEAVY DUTY	EXTRA HEAVY DUTY
ACE EQUIPMENT				
	T.C. Rollers 32, 33, 34, 44, 45, 54, 80	2	B26	
	SB3000	2	B26	
ALLEN				
	K52 Mk11, K64 Mk1	2	BGC2	
	Mobile Crane S184	8	B12A	
	T6D & Diesel	2	B12A	
	T6K	2	B26	
	Trencher (Dorman) T134, Mk1	2	BGC2	
	Trencher 16/60, 12/21	2	BGC2	
	Trencher, C16 14/30 (Dorman)	2	BGC2	
ALLIS CHALMERS				
	Wheel			
	Wheel-AC, C, BC, CA, D10, D12, D14, TB	1	B12A	
	Wheel-CW, WD, WF, V, VC	1	B12A	
	Wheel-D Grader, D17, D19 Diesel	2	B12A	
	Wheel-D15, D17, D19, D270, D270D	1	BN70Z(15)	BN70ZX
	Wheel-Forty Five	4	B26	
	Crawler			
	Crawler-Old Series HD7, HD10	1	B12A	
	Crawler-New Series HD5, GM Engine	4	B12A	
	Crawler-New Series HD9, GM Engine, Old Series HD14	4	B26	
	Crawler-New Series HD15, GM Engines, DH19, HD20	2	BN200	
	Crawler-A.C.Engine HD6, HD11, HD16	4	B12A	
	Crawler-A.C.Engine HD21	2	BN200	
	Motor Graders			
	Motor Graders-All except D & DD	2	BN200	
	Motor Graders-D & DD	2	B26	
	Motor Graders-M100	4	B26	
	Industrial Tractors			
	Industrial Tractors-T160, 200, 260, 360, 460, T560, T650, TL400	1	BN200	
	Industrial Tractors-TL-10D, 12D, 14G, 16G	1	BN150	
	Industrial Tractors-TL-16D, 20D, 30D	2	BN150	
	Industrial Tractors-HD 6A, 6B, 6E, 6EP, 7G	1	BN150	
	Industrial Tractors-10B	2	BDIN85L	
	Industrial Tractors-N5 Header	1	BN70Z(15)	BN70ZX
ARBOS				
	Header	1	BN200	
ARPIC COMPRESSOR				
	185 PD-160	1	BN200	
	120FP-115	2	B12A	
ATLAS COPCO				
	VT5DD	2	BDIN85L	
	VT5FD	2	B26	
	VT6DD, PR365	2	BN120	
	PR600, CUD, PR600 RR, PR600 D/D, PR365 RR	4	BN70Z(15)	BN70ZX
	DT5	2	BN70Z(15)	BN70ZX
	VSS125, 170, 250, 335, XAS80	2	B12A	
	US85, UT85, Deutz XAS60, XAS80 Perkins	2	B12A	
	XAS120, XAS160 Deutz	2	B86	B86Z
AVELING BARFORD				
Dumpers				
	Dumpers-SA Perkins	2	BN200	
	Dumpers-SF, SR11, FL	2	BGC2	
	Dumpers-SL, SN	4	B12A	
	Dumpers-SR	2	BNS70	
Graders				
	Grader-99H	4	B12A	
	Grader-ASGO12	2	BN70Z(15)	BN70ZX

MAKE	MODEL	QTY.	HEAVY DUTY	EXTRA HEAVY DUTY
AVELING BARFORD - continued				
	Grader-LG	2	BN200	
	Grader-MG	2	BNS70	
	Grader-RM	2	BGC2	
	Rollers			
	Rollers-CC Ford., GCU	2	BN150	
	Rollers-GA Perkins or Ford, GD4, 6DS, TR, TRN, TRT, VR	2	B12A	
	Rollers-GD, SA Perkins	2	BN200	
	Rollers-99H & Leyland AU600 & Super	4	B26	
BARBER-GREENE EQUIPMENT				
	44C Ditcher, 422 & 522 Bucket Loader	1	B12A	
	87, 9A Finishing Machine	1	B26	BGC2
BELARUS				
	250, 400	2	B26	
	420, 520, 611, 800, 820, 900, 920	2	B26	
	1500	1	B57MF	B67MF
	7000, 7010, 7910, DON 1500, 1770	2	BN200	
BLAWKNOX				
	Grader BK12	4	B26	
BOBCAT				
	610, 632 - Petrol	2	BN120	
	643, 743, 843 - Diesel	1	BN70Z(15)	BN70ZX
	N155	1	B57MF	B67MF
BOMAG				
	Roller	2 OR 4	B26	
BRAY LOADER				
	All Models	2	B26	
BREEDA				
	50D, 70D	4	B12A	
BRISTOL TRACTOR				
	20-22, 25PC, 25VC	1	BN70Z(15)	BN70ZX
	25D	1	BN70Z(15)	BN70ZX
	Grader	2	B26	
BRITSTAND				
	33P & 35P Combine	1	B12A	
	33D & 35D Combine	2	B12A	
	Model 40 & 41 Grader	2	B26	
	Model 60 Grader	1	BN150	
	20, 21 Grader	1	B26	
BROOMWADE				
	SV78 Perkins, SV128 (HC & 264)	2	B12A	
	SV398, WR250 Leyland	1	BDIN85L	
	WR120, Ford Diesel & Petrol	1	BN70Z(15)	BN70ZX
	SV199, SV245, SV303 Gardner	2	B26	
	SV199, SV245, SV303 Meadows	4	B26	
	WR175, WR210 Ford Diesel	2	B12A	
	WR85, 100, 160	1	BN70Z(15)	BN70ZX
	WR365	2	B12A	
	WR600, 630 Dorman	4	B26	
BUCYRUS				
	10, 19 (2), 22 (4)	2	B12A	
CASE J.I.				
	Agricultural			
	Agricultural-600, 660, 900, 960, 1010, 1660 Combine Petrol	1	B46	B67MF
	Agricultural-660, 900, 960, 1010, 1660 Combine Diesel	2	B26	
	Agricultural-585, 885XL, 2140	1	B86	B86Z
	Agricultural-700, 830, 930	4	B26	
	Agricultural-1030	2	BDIN85L	
	Agricultural- 870, 970, 1070, 1200, 1470	2	B86	B86Z

MAKE	MODEL	QTY.	HEAVY DUTY	EXTRA HEAVY DUTY
JI CASE - continued				
	Agricultural-1640, 2096, 7120, 9130	2	B86	B86Z
Industrial				
	Industrial-Bobcat Perkins Diesel	1	BN70Z(15)	BN70ZX
	Industrial-350 Crawler	2	BN70Z(15)	BN70ZX
	Industrial-450 Angle Dozer & Loader	1	BN150	
	Industrial-420 Terratrak, 530CK, 600 Backhoe	2	B12A	
	Industrial-580 Front End Loader	1	B86	B86Z
	Industrial-800, 1000 Terratrak, 1000C & D	4	B12A	
	Industrial-Trencher TF 100	1	B86	B86Z
	Industrial-Trencher TF200, 300, 600, 700, 30+4	1	B41	B51MF
	Industrial-Trencher TF1000	2	B86	B86Z
	Industrial-W5 Terraloader	1	BDIN85L	
	Industrial-W8B, 10B, W12	2	B03	
	Industrial-W7, 8, 9, 10 FR.Loader, W12 Terra Loader	2	B86	B86Z
	Industrial-W9A, W9 Terra Loader	4	B26	
	Industrial-W24, W26	2	BN150	
	Industrial-1150 Crawler, 1550 Dozer	2	B86	B86Z
	Industrial-1150 Angle Dozer & Loader	4	B26	BGC2
	Industrial-1526, 1530, 1537	1	B57MF	B67MF
	Industrial-2290	2	B86	B86Z
CATERPILLAR				
	D4, D5, 922, 950, 955, 966, 977, D6C, D6B, 57A (Dir. Elec Start)	2	BN150	
	621, 631, 641, 651, 657	2	BN200	
	769, 722, 773	2	BN200	
	922 Traxcavator Jap.	2	BN150	
	950, 966 Traxcavator Jap.	2	BN150	
	950, 966 Traxcavator US	4	B12A	
	D4C 10hp	1	BN70Z(15)	BN70ZX
	D6B Petrol Start	1	B86	B86Z
	933, 922 Traxcavator US	4	B12A	
	992	4	BN200	
	944	4	B26	
	980, 988	2	BN200	
	ALL 600 Range Scrapers	1	BN150	
	D7, D8, D9 Petrol	1	B47	B57MF
	D7, D8, D9 Direct Electric Start	2	BN200	
	112E, 112F Graders	4	B26	
	140G 14 Graders	2	BN150	
	G140 Grader, 55F Series, IT28B	2	B86	B86Z
	12 G12 Grader	1	B12A	
	12 Grader 17K Series	2	B86	B86Z
	12E Grader, 613 Scrapper	4	B12A	
CHAMBERLAIN				
	Industrial			
	Industrial-Champion Mk.3 & Mk.4 70D, 236, 239, 306	2	B26	
	Industrial-Countryman 354, Contractor 354	2	B26	
	Industrial-Champion 4280, 4480	2	B26	
	Industrial-Chamberlain C670, C6100, 4080, 2000 Loader	2	B26	
	Industrial-C456, 212 Industrial, 700 & 791 Loader	1	B89	
	Industrial-800, 894, 895 Loaders	1	B89	
	Tractors			
	Tractors-3380, 4080, 4090, 4280, 4290, 4480, 4490, 4690	2	B26	
CLAAS				
	Dominator 105 (OM360 Mercedes)	1	BNS70	
	Dominator 68S, 98SL, 88S	1	BN120	
CLARK FORKLIFT				
	CF20, CF25, CY260, CY250	1	BNS40Z	
	CY80, CFY80, C60, C70	1	BN50Z	BNS70

MAKE	MODEL	QTY.	HEAVY DUTY	EXTRA HEAVY DUTY
CLARK FORKLIFT - continued				
	CY400	1	BN200	
	Clarkton	1	B46	B57MF
	C500 Series, Y80 Petrol	1	B46	B57MF
	C500 Series, Y80 Diesel	1	BN150	
	C500 Series (HY) 40-55 Petrol	1	BN50Z	BNS70
	C500 Series (HY) 40-55 Diesel	1	B86	B86Z
	C500 Series Y60 (173 Motor)	1	BN50Z	BNS70
	Car Loader, 4000lb., 500lb, 6 VOLT	1	B12A	
	Van Carrier	2	BN200	
	Yardlift 40, 4000lb. Holden 12V	1	BN70Z(15)	BN70ZX
	Yard Lift & Utilitruc 60, 6000, 7000lb Ford Diesel	1	BN150	
	Clark Lift 4000 & 5000lb Perkins P3	1	BN70Z(15)	BN70ZX
	Yard Lift 40, 4000lb. Perkins P3	2	B12A	
CLETRAC				
	SB & ED	4	B26	
	DD	1	BN150	
	FD	1	BN200	
COCKSHUTT				
	Combines 6 Volt 55D, 56D, 57D	1	B12A	
	Combines 12 Volt - All Models	1	B46	B57MF
	500D	2	B26	
COLES CRANES				
	Mobile	2	B12A	
	Lorry Mounted	4	B12A	
	H171 Diesel	1	BN200	
	Prime movers for Cranes	4	B26	
CONVEYANCER FORKLIFT				
	G4-24, MKN, MIB Petrol, M2 Petrol & M16 Diesel	1	BN70Z(15)	BN70ZX
	D4-24, TC4-24, TC5-24, TC6-24,	1	BN70Z(15)	BN70ZX
	TC7-24, TC6 & 7 Yard Model	1	BN70Z(15)	BN70ZX
	PW4, PW5, PW6, PW8	1	B46	B57MF
	TC4, TC5, TC6, TC67/27	2	B12A	
DATSUN FORTLIFT				
	FG, CFG Series	1	B41	
	CF, FO, GFO, FD, PF, GF, QF, PFG, QGF Series	1	BN50Z	BNS70
DAVID BROWN				
	Series 2 880, 990	1	BN150	
	770, 780, 900, 990, Diesels	1	B86	B86Z
	880, 885, 995 Diesels	1	B86	B86Z
	1200, 1210, 1212, 1410, 1412, Diesels	1	B86	B86Z
DEUTZ				
	35, 277, D4006, D5006, D6006	1	BN70Z(15)	BN70ZX
	D3006	1	BDIN85L	
	D7006, D8006, D1006, D13003	1	B86	B86Z
	D50	2	BN70Z(15)	BN70ZX
	DK75	4	B12A	
	9170, R50	2	B86	B86Z
	DX4.51, DX3.65, DX6.30	1	BN150	
DRM.Co				
	Grader	2	BN200	
EUCLID				
	Earthmoving Dump Trucks	1	BN200	
	With Air Start	2	BN150	
FABTEK (Air Lift Platforms)				
	M30	2	B86	B86Z
	V30, V36	1	B46	B57MF
	T40	2	B12A	
	T30	1	B86	B86Z

MAKE	MODEL	QTY.	HEAVY DUTY	EXTRA HEAVY DUTY
FENDT				
	240S, 250S/SA	1	BDIN85L	
	260S/SA, 275SA	1	BDIN85L	
	307LSA	1	BDIN85L	
	308LSA	1	BN150	
	310LSA	1	BN120	
	311LSA, 312LSA	1	BN150	
	614LSA	1	BN150	
	Farmer 200 V, P & S. Series, Tool Carrier 300 Series	1	BDIN85L	
	Favorit 800 Series	2	BDIN85L	
	Favorit 500 (N120 may be too high)	1	BN120	
FIAT				
Wheel Tractors				
	Wheel Tractors-411RB, 415, 422RB, 513R	2	BN70Z(15)	BN70ZX
	Wheel Tractors-211RB, Laverda 3500	1	BN70Z(15)	BN70ZX
	Wheel Tractors-80R	2	B86	B86Z
	Wheel Tractors-450, 500, 500DT, 505C, 605C, 455 & DT, 540, 640, 4WD	1	B94	
	Wheel Tractors-550, 600, 600DT, 600S, 615, 650, 650S, 750, 750S	1	BN150	
	Wheel Tractors-780DT, 880, 880DT, 1180, 1380, 1580, 1880 & DT Models	1	BN150	
	Wheel Tractors-900	1	BN200	
	Wheel Tractors-1000, 1000DT, 1000 Super, 1300 Super, 115-90, 130-90	1	BN150	
	Wheel Tractors-160-90, 180-90, 1180, 1380, 1580, 1880, & DT Models	1	BN150	
	Wheel Tractors-4566, 5066	1	BDIN85L	
	Wheel Tractors-566, 666, 766, 66 Series, 90 Series	1	BN150	
	Wheel Tractors-580, 680, 780, 880, 990 & DT Models, 80 Series	1	B89	
	Wheel Tractors-300, 450, 466 & DT	1	B86	B86Z
	Wheel Tractors-70-90, 80-90, 90-90, 100-90, & DT Models	1	BN70Z(15)	BN70ZX
Crawlers (Fiat Allis)				
	Crawlers-40CAFL4, 311C, 411C, 411C1, 60C1, (AUX ENG), 70C1/204	1	BN70Z(15)	BN70ZX
	Crawlers-455, 505, 650C	1	B94	
	Crawlers-50C1, 40C1	1	B57MF	B67MF
	Crawlers-70C1/205, 80C1	2	B86	B86Z
	Crawlers-AB, BD, FL10, AD, BD, FL14AD12 (24VOLT), 555, KL10	2	BN150	
	Crawlers-FL,60C1, (BATTERY START)	2	BDIN85L	
Bulldozers				
	Bulldozer-650, 665M, 765, 955C, 14C	1	B94	
	Bulldozer-666	1	B89	
FORDSON				
	276	1	B86	B86Z
	876	3	B86	B86Z
	1210	1	B46	B57MF
	1520, 1910, 2100	1	B86	B86Z
	1710	1	BN70Z(15)	BN70ZX
	2000, 3000	1	BDIN85L	
	3400, 3910, 3500	1	B94	
	4000, 4100, 4110, 4400, 4500, 4600, 4610	1	B94	
	5000, 555C, 5610	1	B94	
	6000, 6610	1	B94	
	7000, 7710	1	B94	
	8210, 9600, TW25	1	B94	
	F6000 Series Diesel	1	B89	
	Major Diesel (since 1956)	2	BGC2	
	TR Series	2	B86	B86Z
	TX34	2	BDIN65L	
FOWLER				
	Challenger & Tractor (Meadows Eng.)	2	B26	
	Challenger & Tractor (Meadows Eng.)	1	BN150	
	Challenger Mk111	1	BN70Z(15)	BN70ZX
	Tractor Crane, Movemore	2	B12A	

MAKE	MODEL	QTY.	HEAVY DUTY	EXTRA HEAVY DUTY
GALION				
	Road Grader	2	B26	
	Road Grader Series 118	2	BN200	
HANOMAG				
	22C, 33C, 400C	1	B86	B86Z
	D600D, L600D, Crawlers	1	BN150	
	R28	1	BN150	
	R40 Diesel, K55 Commer, K55E Commer, 45 Std	1	BN70Z(15)	BN70ZX
HINIMOTO				
	R45 Special	2	B26	
	2 Cyl Diesel	1	BN70Z(15)	BN70ZX
	MB 1100 Rotary Hoe	1	B43	B53MF
HODGSON LIFT				
	DG Series Diesel, BG Series Petrol	2	B26	
HOLMAN COMPRESSORS				
	AT8D	1	BDIN53L	
	Trailair 44	1	B03	
	TA130	2	B12A	
	Rotair	2	B12A	
	Rotair 60D	4	B12A	
	VW Engine 12 Volt	1	B43	B53MF
HYSTER FORKLIFT				
	H20-30E Diesel, P40-50A	1	B86	B86Z
	H40-50-60H Diesel, H60-70-80H Petrol, H110-130-150F	1	B46	B57MF
	H165-250E Petrol, P125-180A	1	B46	B57MF
	H165-250E Diesel	1	BN120	
	H300A, M500-600H	1	BN120	
	H360-620B, H700-800A	1	BN200	
INGERSOLL-RAND				
	DL600, 900, 1200, DR900 (1956-65)	2	B12A	
	DR210, 250, 315, 365, 600, IKQ415 (1952-65)	2	BN120	
	GR600, IKQ415 (1952-65)	2	BN120	
	GRA-GRB 125 (1958-65)	1	B46	B57MF
INTERNATIONAL				
Wheel Tractors				
	Wheel Tractors-404, 414, 454, 484, 844, 766	1	B86	B86Z
	Wheel Tractors-624	1	BN150	
	Wheel Tractors-624, 666, 1066, 1256, 1465, 1468, 1566, 806, F806	2	B26	
	Wheel Tractors-674, 844, 4186, 4386, 4586, 5641	1	BN70Z(15)	BN70ZX
	Wheel Tractors-766, 844	1	B86	B86Z
	Wheel Tractors-856, 826, 1026, 1206, 21206, 21256	2	B26	
	Wheel Tractors-4100, 4166, 4366, 4186	2	B26	
	Wheel Tractors-4386, 1086, 1486, 1586	2	BN70Z(15)	BN70ZX
	Wheel Tractors-4568, 4586	4	BN70Z(15)	BN70ZX
	Wheel Tractors-5541	1	B46	B57MF
Two Wheel Drive Loaders				
	Two Wheel Drive Loaders-2554D, A40-2, 3616	2	B12A	
	Two Wheel Drive Loaders-3434	1	B86	B86Z
	Two Wheel Drive Loaders-3500	1	B89	
Crawler & Loaders				
	Crawler & Loader-TD15B-175L, TD15C-175CL	4	B12A	
	Crawler & Loader-TD18-182 Series, TD20-200 Series	2	B26	
	Crawler & Loader-TD20B/250L, BTD20-200 & 210 Series, TD24	4	B26	
	Crawler & Loader-TD20C/250CL	1	BN120	
	Crawler & Loader-TD20E, TD25C, TD25B, TD30	2	BN200	
	Crawler & Loader-TD25-250 SERIES	4	B26	
Pay Loader/Loggers				
	Pay Loader/Loggers-3200A	1	B41	B51MF
	Pay Loader/Loggers-3200B, 3300B	1	B46	B57MF

MAKE	MODEL	QTY.	HEAVY DUTY	EXTRA HEAVY DUTY
INTERNATIONAL - continued				
	Pay Loader/Loggers-D90C, D100B	4	B26	
	Pay Loader/Loggers-D500	4	BN200	
	Pay Loader/Loggers-H80A, H80B, FH65C	2	BN150	
	Pay Loader/Loggers-H90B, H100B, H100C, H90C	4	B26	
	Pay Loader/Loggers-H90E	2	BN200	
	Pay Loader/Loggers-H120 & D120 Series, S9A, S11A	4	B26	
	Pay Loader/Loggers-H400	4	BN150	
	Pay Loader/Loggers-L100	4	B26	
	Pay Loader/Loggers-S7B, S7C, S9B	2	B86	B86Z
Haulers/Scrapers				
	Haulers/Scrapers-PH65B & C, PH140, 270, E270, 412, 442, 431, 444, 443	4	B12A	
	Haulers/Scrapers-PH95, PH100, PH180, 295B, E295B, 350, 340	2	BN200	
	Haulers/Scrapers-E211, E200	2	B26	
Harvesters				
	Harvesters-275, 711	1	BN120	
	Harvesters-403, 503, 175	1	B46	B57MF
	Harvesters-915 Header	2	B26	
Cotton Pickers				
	Cotton Pickers-420 & 422 (D-282)	2	B12A	
	Cotton Pickers-622	1	BN150	
Power Units				
	Power Units-AU264	1		BN70ZX
	Power Units-UDT361, UDT407	2	B12A	
	Power Units-UDT817, UD817	2	BN200	
Excavators				
	Excavators-3960, 3961	2	B26	
ISEKI				
	4270, 4320, 4370, 4410, 4450, 5000, 6000, 7000, 9000, SX95	1	BN120	
	4010, TS350	1	BDIN85L	
	TS, SX75, 4510	1	B86	B86Z
	T6500	2	B46	B57MF
	320, 530, TX1500, TX2160, 2140, 2160, 3210	1	B41	B51MF
J.C.B. EQUIPMENT				
	Wheel Excavators - 2, 2b, 3b, 3c, 3d & all other models	1	B89	
	Track Excavators - 6c, 6d, 7c	2	B26	
	Chaeside - sl series	4	B26	
JOHN DEERE				
	JD300, 400, 400A, JD440 Skidder	2	B46	B57MF
	JD350, 450, 3120, 3130, 1010, 2010, SP105, 670	2	B86	B86Z
	JD540, 740 Skidder, JD544 & 644 Wheel Loader	2	B86	B86Z
	520, 530, 630, 720, 730	2	B12A	
	720, 730, 820, 830 Diesel	4	B12A	
	1020, 1120, 2020, 2120, 2030, 2130	2	B46	B57MF
	5010 Diesel	4	B12A	
	JD2040S	2	BN120	
	4840	2	B47	B58MF
	JD860 Scraper	2	BN120	
	JD780 Windrower	2	BN50Z	BNS70
Combine Harvester				
	Combine Harvester-40, 45, 55	2	B46	B57MF
	Combine Harvester-95	2	B12A	
	Combine Harvester-630, 955, 975, 1065, 1075	1	B86	B86Z
	Combine Harvester-1085	1	BDIN85L	
	Combine Harvester-4400 Diesel	1	BN150	
	Combine Harvester-4420	2	B57MF (x2)	B67MF (x2)
	Combine Harvester-5730, 5830 Self-Propelled	2	BN70Z(15)	BN70ZX
	Combine Harvester-6000 Hi-Cycle	1	BNS70	
	Combine Harvester-6600, 7700 Diesel	1	BN150	

MAKE	MODEL	QTY.	HEAVY DUTY	EXTRA HEAVY DUTY
JOHN DEERE - continued				
	Combine Harvester-6620, 7720, 8820	2	B57MF (x2)	B67MF (x2)
	Combine Harvester-9400, 9500, 9600	2	BNS70	
Cotton Pickers				
	Cotton Pickers-9900	1	BN50Z	BNS70
	Cotton Pickers-9910, 9920, 7440	1	B86	B86Z
	Cotton Pickers-9930, 9940, 9960	1	BN70Z(15)	BN70ZX
	Cotton Strippers-484 (to 1976)	1	BN70Z(15)	BN70ZX
	Cotton Strippers-484 (1976-77)	1	BNS70	
	Cotton Strippers-484 (1978 - on)	1	BN70Z(15)	BN70ZX
	Cotton Strippers-7445	1	BN70Z(15)	BN70ZX
Tractors				
	Tractors-1040, 1140, 1640	2	BN70Z(15)	BN70ZX
	Tractors-1750, 1850, 2345F	1	BDIN85L	
	Tractors-2040S, 2140	2	BN70Z(15)	BN70ZX
	Tractors-2250, 2450, 2650	2	BDIN53L	
	Tractors-2850	2	BDIN53L	
	Tractors-3140, 3350	2	BDIN85L	
	Tractors-3650, 4055, 4255, 4455, 4555, 4755	2	B86	B86Z
	Tractors-4040, 4050, 4240, 4250, 4440, 4450, 4640	2	B26	
	Tractors-8440, 8450, 8650	2	B26	
	Tractors-8560	2	B86	B86Z
	Tractors-8850	3	BN50Z	BNS70
	Tractors-8960	3	BN70Z(15)	BN70ZX
	Tractors-9500	2	B86	B86Z
	Japanese Tractors-850, 950, 1050	1	B86	B86Z
JONES MOBILE CRANES				
	KL22, KL44, KL66	2	B12A	
KADO				
	550	2	B86	B86Z
K.L.(KELLY & LEWIS)				
	M40, N40, P48, S55	1	BN150	
KOMATSU				
	D50, D55, D60, D65, D80	2	BN150	
	D80, D85, D150, D155, D355	2	BN200	
	Forklifts - 25/5, 25/7	1	BNS40Z	
	WA100	1	BN100	
	WAO350	1	BN150	
KUBOTA				
	L185, L245, L275, B6000, 2435, L2550	1	BN70Z(15)	BN70ZX
	L345SS, L405, L295, L345, L285	1	B86	B86Z
	550DT, 895DT, 3750, 4500, M4950	1	BN100	
	B5100E	1	B43	B53MF
	B5200	1	BNS40ZLS	BNS40LMF
	B6000 Petrol, 2400 Series Mowers	1	B46	B57MF
	B6100, B6200	1	B43	B53MF
	B7100, B7200	1	B43	B53MF
	B7100HST	1	BNS40ZLS	BNS40LMF
	G4200, G400-200, G5-200, GT1050	1	BNS40ZLS	BNS40LMF
	M7500, M5500	1	BN150	
	M4050, M4500, M8970	1	B86	B86Z
	KH35 Trencher	1	B41	B51MF
	Tractors-4030, 5030, 6030	1	BN150	
	M Series Tractors	1	BN100	
	6 Cyl Gen. Sets	1	BN150	
	4 Cyl Gen. Sets, L4150, M7030DT	1	BN100	
	T Series, T1400	1	B12N24-4	
LANSING BAGNALL				
	TD200, AMS16, FODR, FOPR, FOGR	1	BN70Z(15)	BN70ZX

MAKE	MODEL	QTY.	HEAVY DUTY	EXTRA HEAVY DUTY
LANSING-HENLY				
	All Models 12 Volt	1	B89	
	All Models 24 Volt	2	B89	
LANZ BULLDOG				
	D1706, D2206, D2416	1	B46	B57MF
	D2803, D2806, D3606, C, H, K, O, Q, R, DR, TDT	1	BN70Z(15)	BN70ZX
	D2416H, L30, N40, P48, S55, ST, DT	1	B26	
LE TOURNEAU WESTINGHOUSE (Wabco)				
	L100, L300 Loaders	2	B26	
	CH. W18, 444 Cummins	4	B26	
	B.T. Pull & C.T. Pull	1	BN200	
	CP, CP6, CFA30, CFA35, CFA50, CFA65	2	BN200	
	CW Tractor	8	B12A	
LEYLAND				
	Tractors 154, 245	1	BN70Z(15)	BN70ZX
	All Other Tractors	1	B89	
LINCOLN WELDERS				
	AK1189, H2, Weldon H6, K1192	1	B43	B53MF
	AS2046 4/2 Generator, AS 1906 4/6 Generator	1	BN70Z(15)	BN70ZX
	DIS-GEN 20, 25, 31 SAM Diesel	1	BN70Z(15)	BN70ZX
	Linc-Welder 225 Petrol	1	B41	B51MF
	Linc-Welder 225D-175 Elec Start, 225 & 300AC-DC	2	B41	B51MF
	400AS Perkins, AS1699	1	BN70Z(15)	BN70ZX
	400AS, 500AS	2	BN50Z	BNS70
MASSEY FERGUSON				
	MF35 Petrol, MF35R, FE35D, FE135P, 135P, RED2, TEA20	1	B46	B57MF
	MF35 Diesel, DEF Diesel, TEF20, FE35D, MF702	2	B26	
	MF30, MF35FE, 550, 575, MF65D, MF85, 88, 90 Diesel	1	B86	B86Z
	203, 205, 203X, 205X, 2135, 3303, & 205 Mk11	1	B86	B86Z
	65R, 65S, 3165S, 135, 165, 168, 2135, 2205, 2203, 3165R	1	B86	B86Z
	Spreader 760, Super 90, 3680	2	B86	B86Z
	85, 88, 90	2	B26	
	178, 1100 (mounting mod. req'd), 3305 (Industrial)	2	B86	B86Z
	MF95 Diesel, 250 Tractor	1	BN70Z(15)	BN70ZX
	510, 585 Header, 587, 750 Header, Late Model MF35	1	B86	B86Z
	542 Header	1	B89	
	154, 254 Italian Series	1	B86	B86Z
	174, 194 Italian series	1	B89	
	130, 175, 178, 185, 188	1	B89	
	335	1	BDIN85L	
	350, 355, 360, 365, 373, 375, 390, 398, 399	1	BDIN65L	
	590	1	B89	
	1085, 1105, 1135, 1155, 1505, 1805	2	B86	B86Z
	3090, 3535, 3630, 3650	1	BDIN65L	
MATBRO				
	Front End Loader	2	B26	
McDONALD				
	Road Roller, 24 Volt	2	BN70Z(15)	BN70ZX
	Road Roller, 12 Volt	2	B26	
MERCEDES				
	1300 Tractor	1	B94	
MICHIGAN (CLARK)				
	55 Series 3, Bedford 330 Engine	2	B26	
	75 and 85, Series 3, GM Engine	1	BN150	
	75 and 85 Series 3, Leyland Engine	2	B86	B86Z
	125, 175, 180 Series 3 All Engines	2	BN120	BN150
	125 Series 3A All Engines	2	BN120	BN150
	280 Series 3 All Engines	2	BN200	
	Series 3 GM Engine	2	B26	

MAKE	MODEL	QTY.	HEAVY DUTY	EXTRA HEAVY DUTY
MICHIGAN (CLARK) - continued				
	B12B Petrol	2	B03	BNS40Z
	B12B Diesel	2	B03	
	Ranger V664, 666 Skidder	2	B86	B86Z
	35A, 35AWS and 45, 55	2	B26	
	55R, 55AWS, 65R, 65AWS, 65A	1	BN120	
	85 Series - 85 - 111A	2	BN120	
MINNEAPOLIS				
	G705 2 Wheel, G706 4 Wheel	2	B26	
	G900, G1000	2	B86	B86Z
MITSUBISHI				
	D1300	1	B43	B53MF
	FG14, FG15	1	BNS40ZS	BNS40MF
	FG20, FG25	1	BDIN53L	
	FD20, FD25	1	BDIN85L	
	FG/D30, FG/D35	1	B46	B57MF
	MG100 Grader	2	BN100	
N.C.K. EXCAVATOR				
	205, 304, 605	4	B26	
NEW HOLLAND				
	1545	2	B26	
	1550 Turbo & 360CC	1	BN70Z(15)	BN70ZX
	103	1	B26	
	261	1	B46	B57MF
	40 Series	1	B86	B86Z
	M/60 Series	1	BDIN65L	
	545D Series	1	B94	
	TX Series	1	BDIN95L	
	4135	1	BDIN95L	
	L35 Series	1	BN150	
NUFFIELD				
	3DL, Nuffield 3, 3/42, 3/45, 10/42	1	B86	B86Z
	DM Perkins Diesel	2	B12A	
	4/60, 10/60, DM4, DM3V, 40M, N4	2	B26	
	4/65	1	B89	
	M4, M, PM, M3V, PM4, PM3, Mini Tractor	1	BN70Z(15)	BN70ZX
OLIVER				
	Wheel Tractor-99, 950	2	B12A	
	Wheel Tractor-1600	2	BN120	BN150
	Wheel Tractor-1800, 1850, 1900, 1950	2	B26	
	Wheel Tractor-12, 90, 165	1	BN120	
	Forklift P50	1	B46	B57MF
	Combines-431	1	B46	B57MF
	Combines-15, 18, 33, 35, 40, 100 Bailer	1	B12A	
	Crawlers-OC3, OC4	1	B12A	
	Crawlers-OC6	2	B12A	
	Crawlers-FDE, OC12, OC18	1	BN200	
	Crawlers-DDH, OC15	1	BN120	
	Crawlers-HG31, HG42	1	B12A	
P & H EXCAVATOR				
	55,105,155 Mobile Crane, 1564, 1566	1	BN70Z(15)	BN70ZX
	Prime Movers for Mobile Cranes	4	B26	
POCLAIN				
	CC120 Excavator	1	B94	
SAME TRACTORS				
	Atlanta, Centauro, Corsaro, Minitauro, Saturno	2	B12A	
	Ariete, Leone	2	B26	
	Buffalo 120, Dragon, Leopard 85, Tiger 100, Centurion	1	BN150	
	Condor 55	1	BN50ZL	BNS70L

MAKE	MODEL	QTY.	HEAVY DUTY	EXTRA HEAVY DUTY
SAME TRACTORS - continued				
	Dolfinio 35, Aurora 45, Falcon	1	B86	B86Z
	Mini Taurus	1	BN120	
SHIBAURA				
	1300, 1340, S320	1	BN50Z	BNS70
	S330, SD5040T, 4000, 4050, 3000, 3040	1	BN100	
	S445	1	BDIN85L	
	U490F	1	BN150	
	1600, 1640, 2500, 2540	1	BN70Z(15)	BN70ZX
STACA/STACATRUC				
	All Models	1	BN70Z(15)	BN70ZX
STEYR DAIMLER				
	80 With Starter, 180	1	BN70Z(15)	BN70ZX
STEIGER				
	Some Models	1	BN200	
	Some Models	3	B86	B86Z
	Some Models	4	B86	B86Z
SUMITOMO				
	LS 2800 Excavator	1	B94	
T.C.M.				
	FG10, FG14	1	B41	B51MF
	FG20, FG25	1	B46	B57MF
	FD25	1	BDIN85L	
	FD35	2	BN120	
	FD100	2	BN150	
TENNANT				
	Sweepers 220, 240, 92, 92AA, 92SE210, 265, 280	1	BN50Z	BNS70
	Scrubbers	1	BN50Z	BNS70
TOFT				
	Mk 1	2	B26	
	Mk11 Mercedes 10	2	B89	
	Mk111 Caterpillar	2	BN200	
TOW MOTOR				
	600, 7000, 8000lb, 680P	1	B12A	
	Mk.11 Pacemaker	1	BN70Z(15)	BN70ZX
TOYOTA FORKLIFTS				
	FCG10, 15, 20, LC6, FG35	1	B47	B58MF
	FDT25, FD32-35, FD40, FDC20-25, FDC30	2	BN50Z	BNS70
	FB10-15, FDA50-60, FD80, FD100, FD150, FDA150, FD250	2	BN50Z	BNS70
	FG7, 9, 2FG20-25	1	B41	B51MF
	2FD-10, 2FD-15, 2FD20-25, FDT25	1	B41	B51MF
	2FD30	2	BN50Z	BNS70
	2FD40-60	2	BN50Z	BNS70
	2FG25	1	B47	B58MF
	FG30, 2FG32-35, 2FG40, 2FG50-60, FCG10-15	2	BN50ZL	BNS70L
	2FGC30, FB5, 7, 9, FB20-25, FB30, FB40	2	BN50ZL	BNS70L
	3FG10, 3FG15	1	B41	B51MF
	3FGC20-25	2	BN50ZL	BNS70L
	TG10	1	B46	B57MF
	SKD4 Loader	1	B86	B86Z
	SKD6 Loader	2	B86	B86Z
	All Others		BN50ZL	BNS70L
TRACK MARSHALL				
	All Models	2	B12A	
TURNER				
	Diesel, Mk11	1	BDIN85L	BDIN95L
TUTT BRYANT				
	Pengo Earth Boring Machine	1	BN50Z	BNS70
	Little Ford Spray Master	1	B26	

MAKE	MODEL	QTY.	HEAVY DUTY	EXTRA HEAVY DUTY
TUTT BRYANT - continued		1	B12A	
	Pacific Rlller Truck	1	BN70Z(15)	BN70ZX
TWIN CITY				
	Baler, U. & G. TO 1953	1	B12A	
	Baler, U. & G. 1954-55	1	BN70Z(15)	BN70ZX
	G.B.D.	2	BN200	
UNIMOG (MERCEDES BENZ)				
	30D Mercedes Benz	1	B86	B86Z
	800, 1000, 1500 Tractor	1	BN120	
	1700L	1	B57MF	
URSUS				
	2812, 3512,	1	B86	B86Z
	912, 914, 1014	1	B26	
U.T.B. UNIVERSAL				
	U650M	1	BN150	
	445, 445DT, 550 Farmliner	1	B94	
VAL PADANA				
	260, 330	1	B47	B58MF
	330RS, 350, 450, 455, 545RS	1	BN70Z(15)	BN70ZX
	555RS, 7060RS, 7070RS	1	BN70Z(15)	BN70ZX
VENDOR				
	DR80	1	BN70Z(15)	BN70ZX
VERSATILE				
	4WD Tractor	1	BN200	
VICKERS ARMSTRONG				
	2000, 2600	2	BDIN53L	BDIN53L
VOLVO				
	L50, L70 Loader	1	BDIN85L	
WABCO				
	111A Scraper	4	B12A	
	333F Scraper	2	BN200	
	Haulpak 170 Tonne	2	B86	B86Z
WALTANIA				
	Trac 2000	1	BN150	
WHITE				
	2150, 4250, 4280, 2-155, 2-180, 4-120, 4-175	2	B86	B86Z
	285, 2105	1	BN120	
	2/135	1	B86	B86Z
YALE FORKLIFT				
	G & GP Series	1	B12A	
YANMAR				
	D Diesel	1	BDIN85L	
	336	1	BDIN85L	
ZETOR				
	2511, 3545, 3511	1	BDIN85L	
	4511	2	B86	B86Z
	4712	1	B86	B86Z
	5211, 5245	1	BN150	
	5511, 5545	2	B86	B86Z
	5711	1	B86	B86Z
	6211, 6245	1	BN150	
	6745	1	B86	B86Z
	7211, 7245, 7711, 7745	1	BN150	
	8011, 8045	1	B86	B86Z
	8111, 8145, 9111, 9145	2	B86	B86Z
	10111, 10145	2	B86	B86Z
	12011, 12045	1	B86	B86Z
	12111, 12145, 14145, 16145	2	B86	B86Z