

BOSCH

Use and Care Manual

For Household Use Only

Notice d'utilisation et d'entretien

Usage domestique uniquement

Manual de instrucciones y cuidado

Sólo para uso doméstico

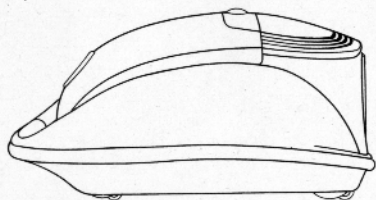

BSG81...UC Vacuum cleaner

Use and Care Manual 3

Notice d'utilisation et d'entretien 20

Manual de instrucciones y cuidado 37

Important Safeguards

Use as directed

NOTE

This vacuum cleaner is intended for use in the home and not for industrial purposes.

The vacuum cleaner must be used exclusively in accordance with the specifications stated in the instructions.

The manufacturer shall not be held liable for any damages which arise from use which is not as directed or has been caused by an incorrect operation of the vacuum cleaner. Therefore, please ensure that the following information is observed and heeded.

Safety information

READ ALL INSTRUCTIONS BEFORE USING THIS APPLIANCE

 **WARNING** - To reduce the risk of fire, electric shock, or injury:

CAUTION

- **Do not** leave appliance when plugged in. Unplug from outlet when not in use and before servicing.
- **Do not** use outdoors or on wet surfaces.
- **Do not** allow to be used as a toy. Close attention is necessary when used by or near children.
- **Do not** use with damaged cord or plug. If appliance is not working as it should, has been dropped, damaged, left outdoors, or dropped into water, return it to a service center.
- **Do not** pull or carry by cord, use cord as a handle, close a door on cord, or pull cord around sharp edges or corners. Do not run appliance over cord. Keep cord away from heated surfaces.
- **Do not** unplug by pulling on cord. To unplug, grasp the plug, not the cord.
- **Do not** handle plug or appliance with wet hands.
- **Do not** put any object into openings. Do not use with any opening blocked; keep free of dust, lint, hair and anything that may reduce air flow.
- **Do not** use to pick up flammable or combustible liquids, such as gasoline, or use in areas where they may be present.
- **Do not** pick up anything that is burning or smoking, such as cigarettes, matches, or hot ashes.
- **Do not** use without dust bag and/or filters in place.
- **Do not** vacuum up damp substances or liquids to avoid electrical shock hazards.
- **Do not** operate the brush on or next to people or animals or let the tube or nozzles get close to your face or head to prevent entanglement or possible injury from flying debris.
- **Do not** operate the vacuum if any part of it is damaged to prevent injury to the operator or bystanders.

- **Do not** use machine as a step.
- **Do not** re-use or wash the filters.
- **Do not** remove any screws.
- **Do not** vacuum up sharp objects to prevent injuries when opening or emptying the appliance.
- **Do not** use a damaged vacuum appliance.

- **Do** operate the appliance only with original dust bags.
- **Do** operate the appliance only by using original spare parts, accessories or optional accessories. Use only as described in this manual.
- **Do** connect and start up the vacuum cleaner only in accordance with the information stipulated on the identification plate.
- **Do** protect the vacuum cleaner from external weather conditions, dampness and heat sources.
- **Do** switch off and unplug the appliance before any assembly, cleaning and before servicing.
- **Do** supervise children whenever they are around an operating appliance to prevent injury to the child and possible damage from misuse of the appliance.
- **Do** switch off and unplug the appliance if it stops sucking or at the event of any other fault.
- Keep hair, loose clothing, fingers, and all parts of body away from openings and moving parts.
- Turn of all controls before unplugging.
- Use extra care when cleaning on stairs.
- Hold plug when rewinding onto cord reel. Do not allow plug to whip when rewinding.
- Unplug before connecting the Turbo Universal floor brush.
- Use only as described in this manual. Use only manufacturer's recommended attachments.
- To reduce the risk of electric shock, this appliance has a polarized plug (one blade is wider than the other). This plug will fit in a polarized outlet only one way. If the plug does not fit fully in the outlet, reverse the plug. If it still does not fit, contact a qualified electrician to install the proper outlet. Do not change the plug in any way.
- The hose contains electrical wires. Do not use when damaged, cut, or punctured. Avoid picking up sharp objects.
- Always turn off this appliance before connecting or disconnecting either hose or motorized nozzle.

SAVE THESE INSTRUCTIONS!

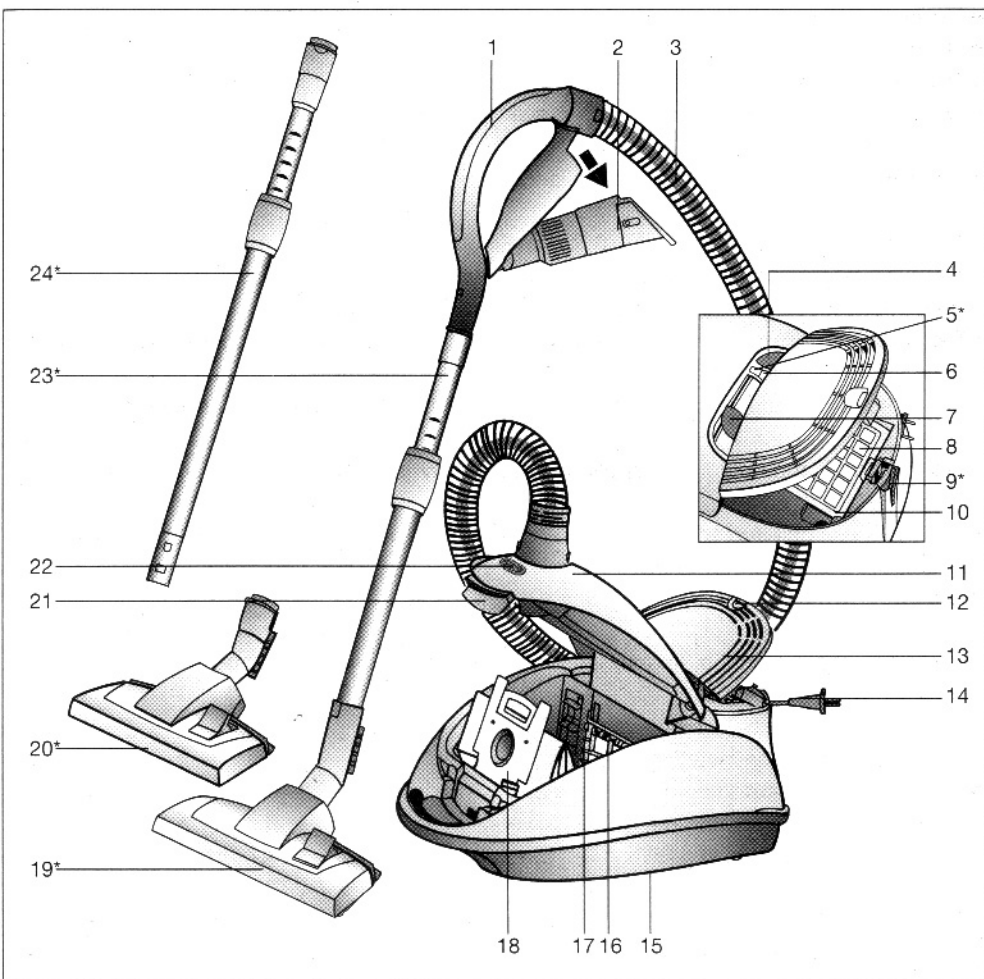

- | | |
|--|--|
| 1 Ergoplus handle with integral accessory holder | 14 Power cord |
| 2 4in1 accessory | 15 Parking aid (on unit underside) |
| 3 Suction hose | 16 Motor protection filter |
| 4 ON/OFF button | 17 Filter bracket |
| 5 Power indicator* | 18 MEGAfilt®plus dust bag |
| 6 Change dust bag indicator | 19 Dual action nozzle with carpet lifter* |
| 7 Suction adjustment | 20 Dual action nozzle with carpet lifter and snap connector* |
| 8 Exhaust filter | 21 Dust compartment latch |
| 9 Parking aid (with automatic OFF*) | 22 Socket for electrobrush |
| 10 Frame for exhaust filter | 23 Telescopic tube with sliding sleeve* |
| 11 Dust compartment cover | 24 Telescopic tube with sliding sleeve and snap connector* |
| 12 Exhaust grille latch | |
| 13 Exhaust grille | |

* depending on design

Starting up

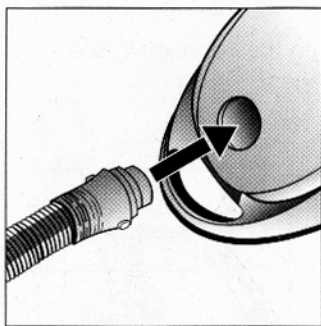

Insert the suction hose connector into the suction opening until it engages.

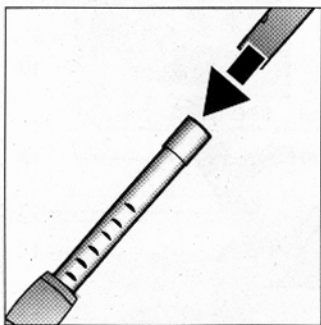

Connect the handle and the telescopic tube together.

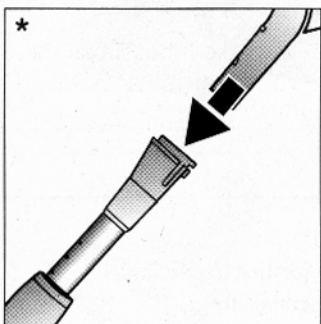

Push the handle into the telescopic tube until it engages.

*Depending on version

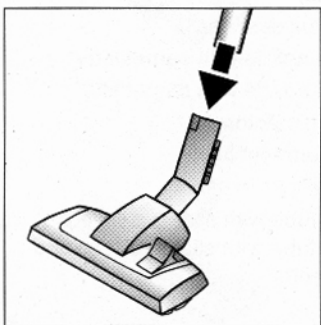

Connect the floor nozzle and the telescopic tube together.

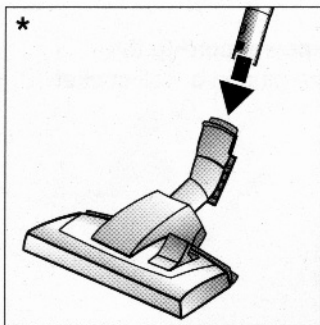

Push the telescopic tube into the connecting piece of the floor nozzle until it engages.

*Depending on version

Electrobrush (Depending on version)

For notes on the use and maintenance of the electrobrush, see the separate instruction manual provided.

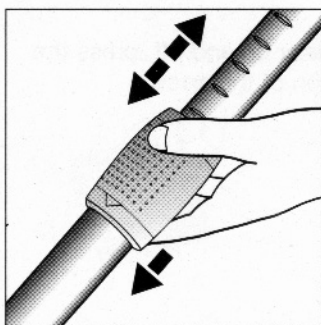

To adjust the length of the telescopic tube, press the sliding sleeve in the direction of the arrow and adjust the tube to the required length.

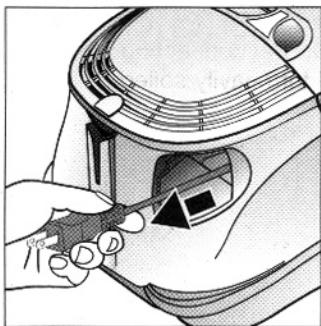

Grasp the plug and pull the power cord to the required length and insert the plug in a wall socket.

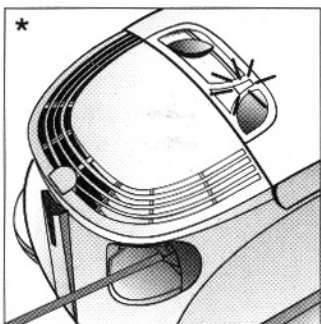

If your unit has an electronically operated power cord reel, the Power indicator now lights up green.

*Depending on version

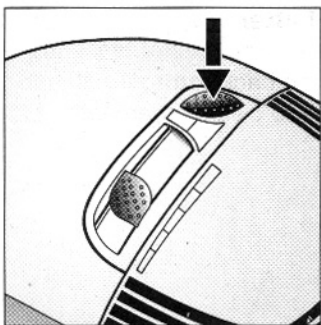

To switch your vacuum cleaner on and off, press the ON/Off button in the direction of the arrow.

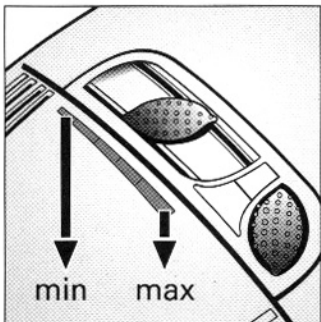

Use the suction adjuster to adjust the suction to the required level.

- Low suction range:
For cleaning delicate fabrics, such as curtains.
- Middle suction range:
For daily cleaning of lightly soiled surfaces.
- High suction range:
For cleaning durable floor coverings, hard floors and for heavily soiled surfaces.

Vacuating

IMPORTANT

You have bought an extremely powerful device.

The highest suction setting is therefore only recommended for heavily soiled, durable carpeted and hard floors.

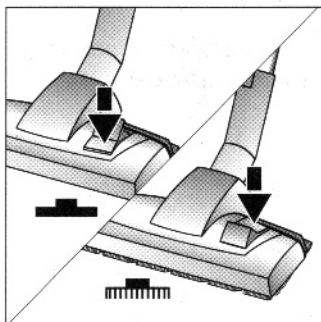

Adjusting the floor nozzle:

- For cleaning rugs and carpets
- For cleaning hard floors

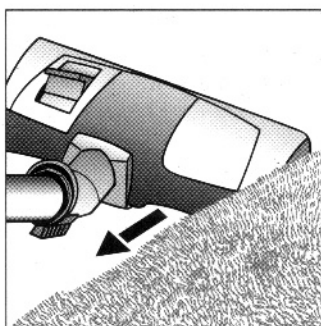

Floor nozzle with carpet lifter

When you pull the floor nozzle backwards, the rug is lifted, allowing you to clean underneath the carpet edge.

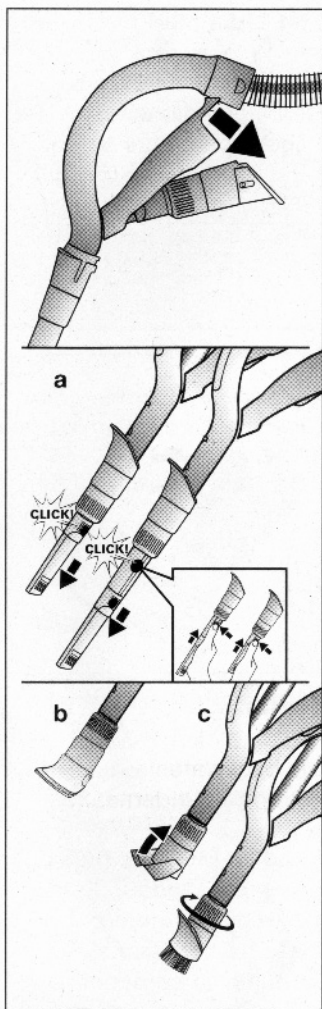

Vacuuming with accessories

Pull the 4in1 accessory in the direction of the arrow to remove it from the accessory holder.

a) Crevice nozzle

For vacuuming in crevices and corners. For difficult to get to places, the 4in1 accessory can be extended in two stages to 14 inches (or 360 mm) by pulling out the crevice nozzle.

- Extend the crevice nozzle to the second stop until you can hear it engage.
- To push the crevice nozzle together again, release the telescope lock (by pressing in arrow direction).

b) Upholstery nozzle

For cleaning upholstery, curtains, etc.

c) Furniture brush

For window frames, cabinets, lamp shades etc.

- Fold the upholstery nozzle over in the direction of the arrow.
- To extend the brush ring, turn in the direction of the arrow.
- Before replacing the 4in1 accessory in the accessory holder, retract the brush ring and fold the upholstery nozzle back.

- !** **Caution:** to prevent damage to the nozzle / furniture brush, fold the upholstery nozzle out only when the furniture brush is retracted.

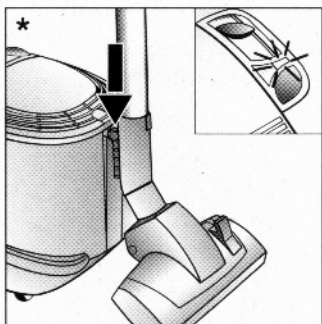

When you stop cleaning for a moment, you can use the parking aid at the back of the vacuum cleaner. Slide the plastic tab on the nozzle connector into the groove at the back of the vacuum cleaner. If your cleaner has the automatic Off function, it will now switch itself off.

=> Power indicator lights up "green".

*Depending on version

After work

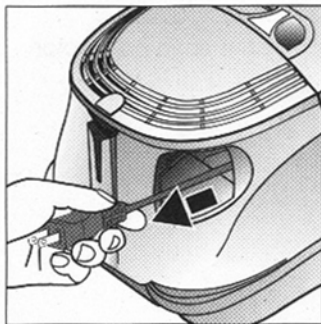

- Switch the vacuum cleaner off and unplug the power cord.
- Tug the power cord and let go. The power cord then winds itself up automatically.
- On vacuum cleaners with an electronically operated power cord reel, the power cord is automatically wound up when you pull the plug out of the wall socket.
- To activate the power cord brake again, pull the power cord.
To deactivate the power cord brake, quickly tug the power cord.
=> The power cord then continues to be wound up.

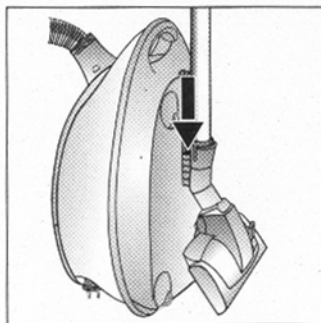
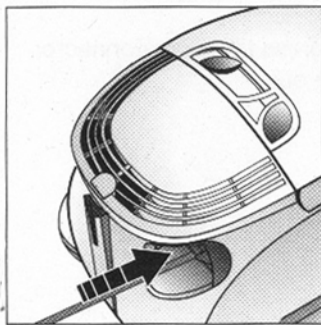

To store or transport the vacuum cleaner, you can use the parking aid on the cleaner's underside. Place the vacuum cleaner upright. Slide the plastic tab on the floor nozzle into the groove on the unit underside.

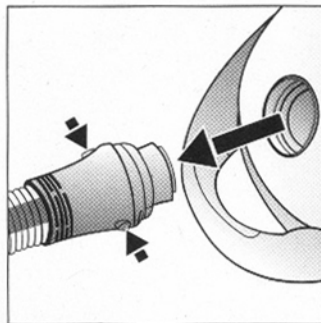

To remove the suction hose, press the two buttons together, and pull the hose out.

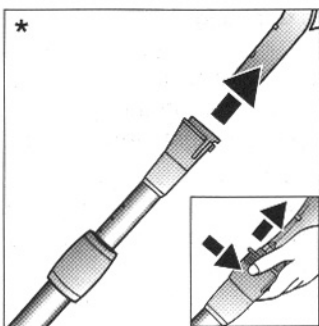

To release the connection, press the snap connector and pull the handle out.

*Depending on version

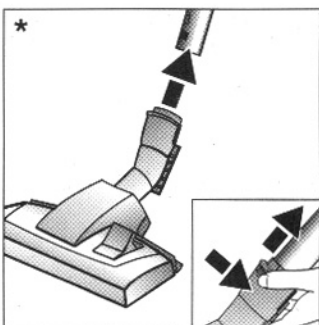

To release the connection, press the snap connector and pull the telescopic tube out.

*Depending on version

Changing the dust bag

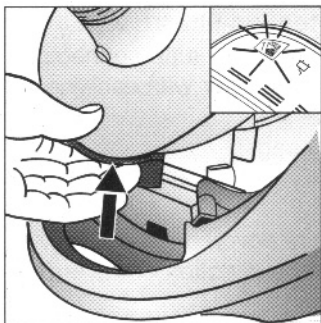

Replacing the MEGAfilt®plus dust bag

- The change dust bag indicator lights up red.
- Operate the dust compartment latch in the direction of the arrow to open the dust compartment cover.

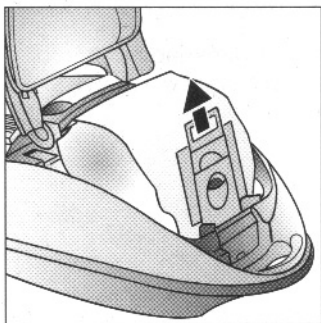

Seal the MEGAfilt®plus dust bag by pulling the sealing strip and pull up to remove the bag.

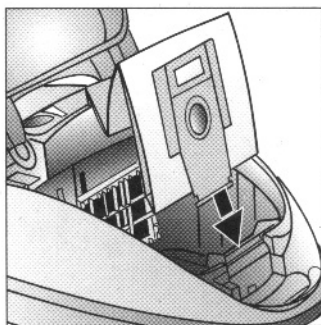

Place a new MEGAfilt®plus dust bag into the holder and close the dust compartment cover.

Important

- A MEGAfilt®plus dust bag or textile filter must be properly in place or the dust compartment cover will not close. Do not force the cover if it does not close easily. Inspect the bag installation and adjust it as needed.

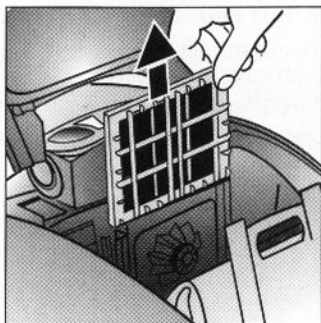

Replacing the motor protection filter

You should change the microsan filter with each new replacement dust bag pack (at least after every five dust bags).

- Open the dust compartment cover.
- Pull the filter holder out in the direction of the arrow and open it.
- Dispose of the motor protection filter and fit a new motor protection filter.
- Close the filter support, slide into the vacuum cleaner and close the dust compartment cover.

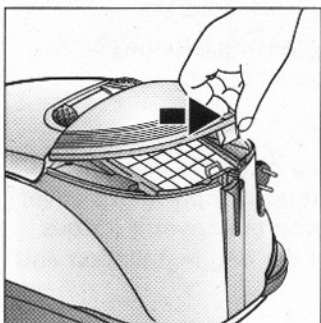
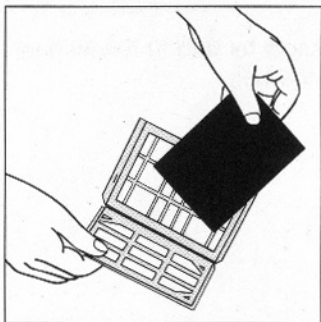

Replacing the micro-hygiene filter*

You should change the microsan filter with each new replacement filter pack (at least after every five dust bags).

Press the exhaust grille latch in the direction of the arrow to unlatch the exhaust grille and open it.

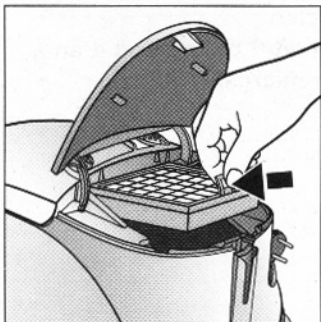

Press the filter frame latch in the direction of the arrow to unlatch the filter frame and remove it.

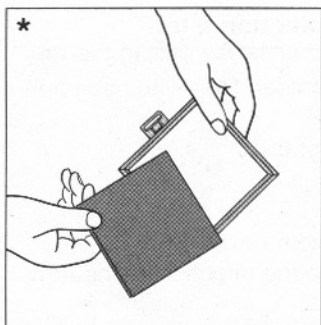

Remove the foam and the microsan filter.

*Depending on version

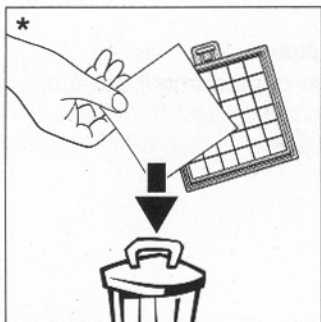

Dispose of the used microsan filter and fit a new one.

*Depending on version

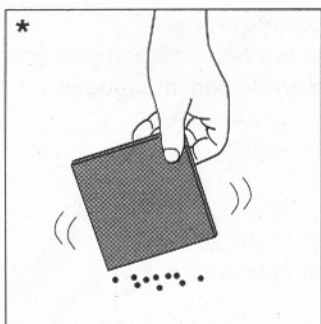

Clean the foam and replace in the filter frame.

*Depending on version

If you have used the vacuum cleaner for fine dust particles (such as plaster or cement), clean the motor protection filter by tapping it and, if necessary, replace the motor protection filter and the microsan filter.

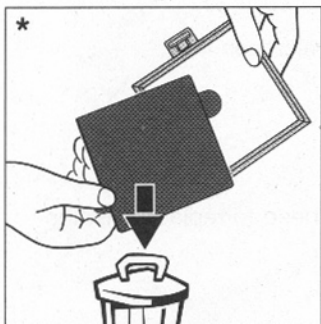

Remove the activated carbon filter by pulling the tab and dispose of it as normal

*Depending on version

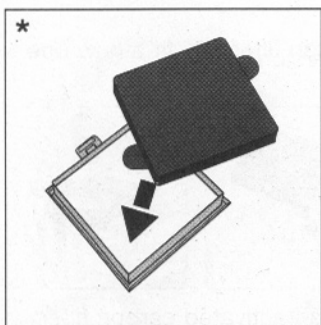

Fit a new activated carbon filter.

*Depending on version

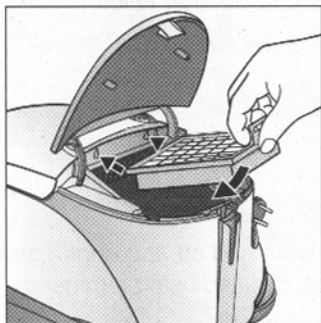

- Slide the filter frame under the two retaining ribs and turn in the direction of the arrow until it engages.
- Close the exhaust grille.

Replacing the HEPA filter (Depending on version)



If your vacuum cleaner is equipped with a HEPA filter, you need to replace this filter once a year.

Replacing the activated carbon filter (Depending on version)

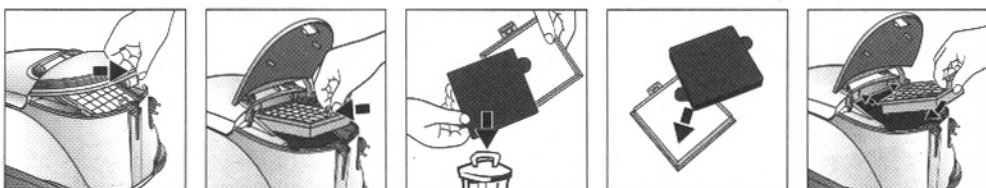

If your vacuum cleaner is equipped with a HEPA filter and an activated carbon filter, you need to replace the HEPA filter yearly and the activated carbon filter twice a year.

Maintenance

- Before the appliance is cleaned, ensure that it has been switched off and unplugged.
- Vacuum cleaners and accessories made of plastic can be cleaned using a general commercial plastic cleaner.

**Do not use scouring agents, glass or all-purpose cleaners.
Never immerse the vacuum cleaner in water!**

- If necessary, the dust compartment can be cleaned using another vacuum cleaner, or simply cleaned with a dry dust cloth / dust brush.

Spare parts and optional accessories

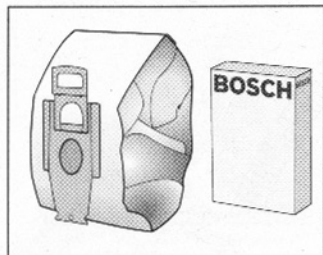

Replacement dust bag packaging BBZ 52AFPUC

contains :

5 MEGAfil[®] plus replacement dust bags with auto-seal

1 Microsan filter

1 protective motor filter

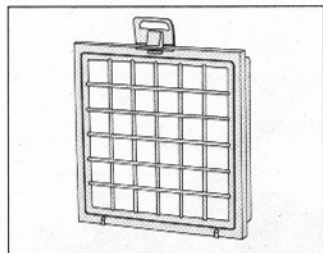

HEPA filter BBZ151HFUC

Recommended for allergy sufferers. Purifies the discharge air so that it is cleaner than the normal ambient air. Filters even such small particles that it complies with the European standard for clean air of HEPA class 12.

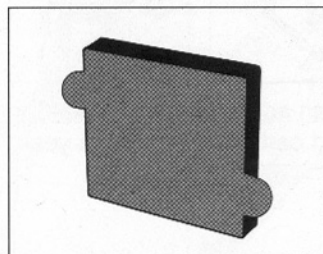

Activated carbon filter BBZ190AFUC

Extra thick activated carbon cushion permanently prevents irritating odors.

May only be used in conjunction with the discharge filters on the BSG8.. series.

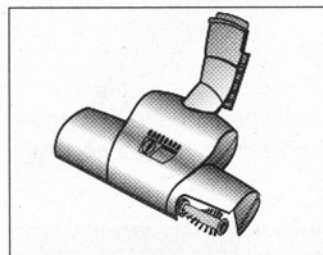

Turbo brush for floors BBZ 101TBUC

Brushes and vacuums simultaneously. Suitable for all floors. Good pick-up of fluff, threads and hairs.

Flattened pile is restored. Side air control for adapting roller speed to floor type. The brush roller is driven by the suction power of the vacuum cleaner.

No electrical supply required

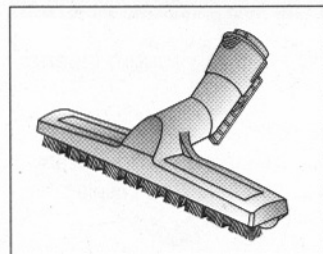

Brush for parquet and hard floors BBZ 121HDUC

Specially for parquet and sensitive hard floors

Fitted with 2 castors and extra soft bristles, glides over floors effortlessly, taking up dust, dirt from cracks and crevices.

BOSCH Small Appliance Warranty

BSH Home Appliances («BOSCH») warrants all new small appliances to be free from original defects in design, materials and workmanship for one (1) year after the sale to the original owner.

Within the stated warranty period, BOSCH will repair or replace, at its sole option, any small appliance or parts thereof which prove defective under the conditions of normal use and service at no charge to you. It is the owner's responsibility to return the appliance for repair. Repaired and replacement small appliances and parts shall be the same or as close in appearance as possible to the original for the purposes of this warranty.

Should you require service of your BOSCH small appliance, please contact customer service at 1-866-44-BOSCH. Repair of BOSCH appliances should only be performed by qualified technicians.

This warranty is limited to the original consumer purchase and is not transferable. Specifically excluded from this warranty are failures caused by accident, misuse, neglect, abuse, including tampering, use of frequency or voltage other than marked on the product, and use for commercial purposes.

To the extent allowed by law, this warranty sets out your exclusive remedies, whether for negligence or otherwise. BOSCH will not be liable for any consequential or incidental damages, losses or expenses.

THIS WARRANTY IS IN LIEU OF ALL OTHER EXPRESSED WARRANTIES. ANY WARRANTY IMPLIED BY LAW, WHETHER FOR MERCHANTABILITY OR FITNESS FOR A PARTICULAR PURPOSE OR OTHERWISE, SHALL BE EFFECTIVE ONLY FOR THE PERIOD THAT THIS EXPRESSED WARRANTY IS EFFECTIVE. BOSCH DOES NOT ASSUME ANY RESPONSIBILITY FOR INCIDENTAL OR CONSEQUENTIAL DAMAGES.

No attempt to alter, modify or amend this warranty shall be effective unless authorized in writing by an officer of BOSCH. Some states do not allow limitations on how long implied warranties last or the exclusion or limitation of incidental or consequential damages, so the foregoing limitations and exclusions may not apply to you. This warranty gives you specific legal rights and you may also have other rights which vary from state to state.

BSH Home Appliances Corporation
5551 McFadden Avenue
Huntington Beach, CA 92649
USA

Web site: www.boschvacuums.com

Customer Service (toll free): 1-866-44BOSCH (1-866-442-6724)