

# Installation Instructions

## DS720i Long Range Dual PIR/Microwave Intrusion Detector

### 1.0 Description

The DS720i is a long range dual passive infrared (PIR)/microwave (mW) intrusion detector that utilizes state-of-the-art signal processing to maximize catch performance and reduce false alarms.

### 2.0 Specifications

- **Description:** DS720i Long Range Dual PIR/Microwave Intrusion Detector.
- **Input Power:** 9 to 15 VDC, 32 mA DC nominal @ 12.0 VDC (up to 60 mA DC during walk testing, stored alarms, or trouble conditions).
- **Standby Power:** There is no internal standby battery. Connect to DC power sources capable of supplying standby power if primary power fails. 32 mA-H required for each hour of standby time needed. *Four hours (128 mA-H) minimum are required for Underwriters Laboratories' Certificated installations.*
- **Alarm Relay:** Silent operating Form "C" reed relay. Contacts rated 3 watts, 125 mA, 28 VDC maximum for DC resistive loads; and protected by a 4.7 ohm, 1/2 Watt resistor in the common "C" leg of the relay. Do not use with capacitive or inductive loads. Alarm relay contacts on terminals 3,4 and 5.
- **Tamper:** Normally Closed (with cover in place) tamper switch. Contacts rated at 28 VDC, 125 mA maximum. Tamper contacts on terminals 6 and 7.
- **Trouble:** Normally Closed dry contact output on terminals 8 and 9. The contacts are rated at 28 VDC, 125 mA maximum. Open during trouble condition.
- **Operating Temperature:** -20° to +120°F (-29° to +49°C). *For U.L. Listed Requirements, the temperature range is +32° to +120°F (0° to +49°C).*
- **Microwave Frequencies:**
  - **DS720i:** 10.525 GHz
  - **DS720i-A:** 9.9 GHz
  - **DS720i-B:** 10.687 GHz
- **Coverage:**

**Standard Broad:** 90 ft. by 70 ft. (27 m by 21 m) (OA90)  
**Optional Long Range:** 120 ft. by 25 ft. (37 m by 8 m) (OA120)  
**Standard Long Range:** 300 ft. by 15 ft. (91 m by 4.6 m) (OA300)
- **Options:** TC6000 Test Cord and OA120 Optical Module.
- **U.S. Patent Numbers:** # 4,660,024, # 4,764,755, #5,077,548, #5,083,106, # 5,208,567, # 5,262,783, and # 5,450,062.  
Other patents pending.
- **Dimensions:** 8.25 in. L x 5 in. W x 5.19 in. H (21 cm L x 13 cm W x 13.2 cm H)

### 3.0 Installation Hints

**Never** install the detector in an environment that causes a constant alarm in one technology; it should never be left to operate with the green, yellow or red LED ON.

Point the unit **AWAY** from outside traffic (e.g. roads, alleys, and parking lots). **Remember:** Microwave energy will pass through glass and most common nonmetallic construction walls.

Point the unit **AWAY** from glass exposed to the outdoors and objects that may change temperature rapidly.

**Remember:** The PIR detector will react to objects rapidly changing temperature within its field-of-view.

Avoid installations where rotating machines (e.g. ceiling fans) are normally in operation within the coverage pattern.

If using the anti-mask feature, avoid locations where people or objects may be moving within 3 ft. (1 m) of the detector.

### 4.0 Mounting

Select a location that is most likely to intercept an intruder moving across the coverage pattern (review coverage patterns on page 6). The recommended mounting height for the 300 ft. x 15 ft. (91 m x 4.6 m) coverage is 10 ft. (3 m). The recommended mounting height for the 90 ft. x 70 ft. (27 m x 21 m) and 120 ft. x 25 ft. (36.6 m x 8 m) coverages is 7.5 ft. (2.3 m). The surface should be solid and vibration-free.

Remove the cover by inserting a flathead screwdriver or other flat object into the slot at the bottom of the cover, and twist until the cover snaps free of the front tabs on the base. Lift the cover up and away to clear the rear base tabs. Do not bend or remove the microwave antenna located on the front of the permanent reflecting mirror.

Remove the circuit board from the base by pressing the two circuit board retainer tabs outward while lifting the circuit board away from the base.

Select and break away the appropriate thin wall wire entrance and mounting hole coverings in the base.

Using the base as a template, mark the location of the mounting holes on the mounting surface, and pre-start the mounting screws.

Route wiring as necessary to the rear of the base and through the wire entrance, then firmly mount the base to the mounting surface.

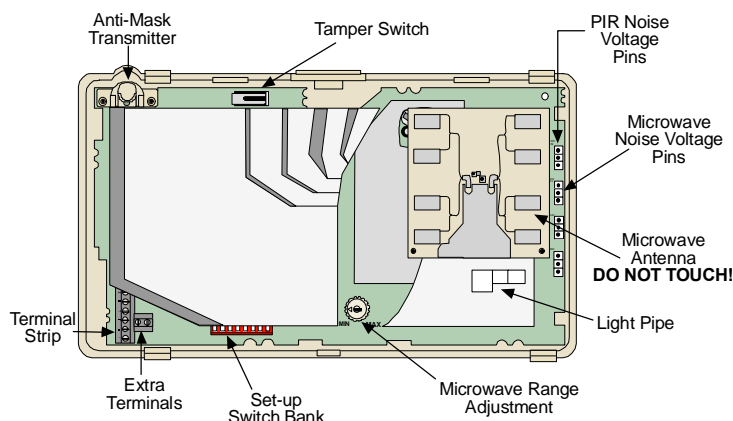
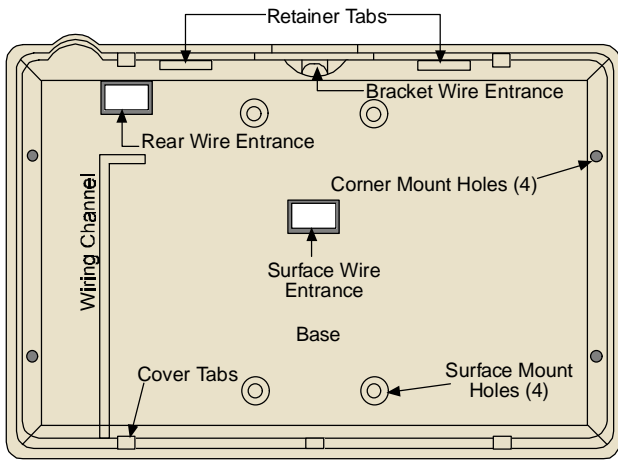

Figure 1: Inside View of DS720i





**Figure 2: DS720i Base**



**Be sure all wiring is unpowered before routing.**

Return the circuit board to the base by first inserting the bottom of the circuit board into the cutouts at the bottom of the base, then snapping the top into place.

### 3.1 Tamper Switch Installation

The tamper switch is designed to prevent any unauthorized opening or manipulating of the B334 Mounting Bracket once it has been mounted. The tamper switch mounts to the inside of the bracket using the supplied circuit board mount.

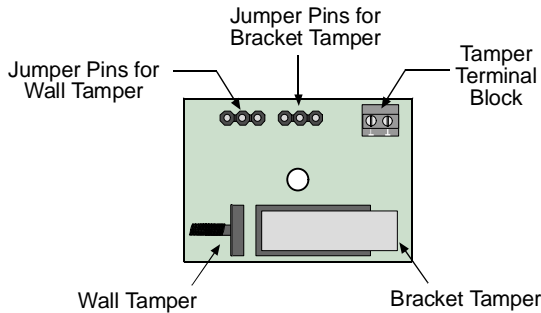

**Figure 3: Optional Tamper Switch**

Refer to Figure 4 when installing the tamper switch into the B334 Mounting Bracket.

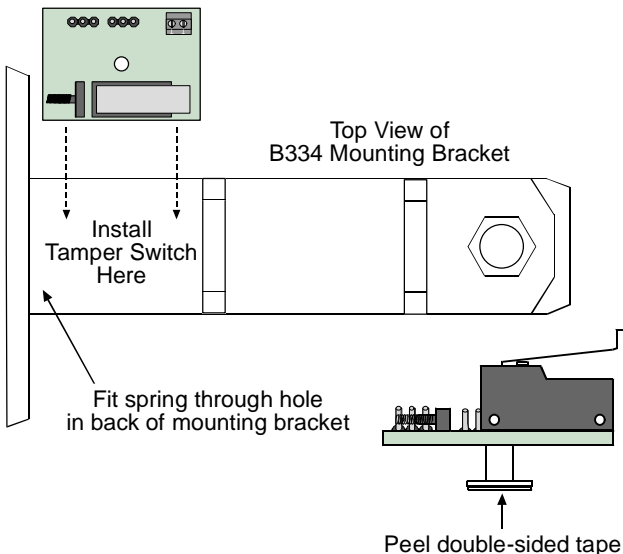

**Figure 4: Installing the Tamper Switch**

The tamper switch's jumper pins determine whether the wall tamper and bracket tamper features are enabled or disabled. See Figure 5 to set the jumper pins.

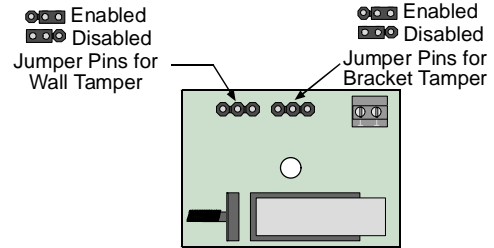

**Figure 5: Wall/Bracket Tamper Switch Jumper Pins**

Figure 6 shows how to wire the tamper switch's terminals to the control panel and the DS720i.

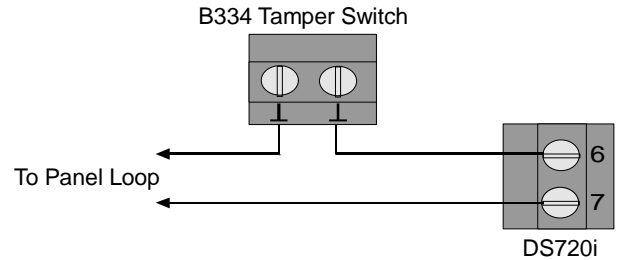

**Figure 6: Wiring the Tamper Switch**

### 3.2 B334 Bracket Mounting

Mount the B334 to a standard single gang switch or outlet box using the supplied screws. If the unit is to be surface mounted, use the wall screw/anchor assemblies or appropriate alternatives.

Slide the mirror from the black mirror mounting assembly when feeding the power wiring through the detector base to the terminal strip if required.

Refer to Figure 7 when mounting the DS720i to the B334 Mounting Bracket.

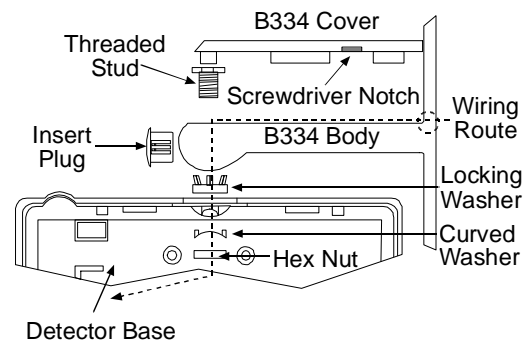
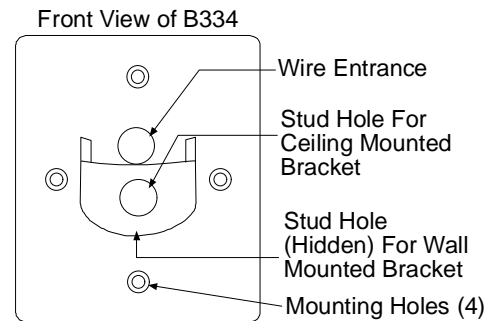

**Figure 7: Mounting the B334 Bracket**

### 3.3 Mirror Replacement

The DS720i comes with two mirrors: OA300 (pre-installed), and OA90 (optional). The mirrors slide on and off the mirror stand. To replace the mirror, use the following steps:

- 1) Hold the base with one hand if the unit has not been mounted.
- 2) Use the other hand to pull the mirror off the mirror stand in an upward-diagonal direction.
- 3) Align the runners on the inside of the mirror with the grooves on the mirror stand.
- 4) Slide the mirror onto the mirror stand in a downward-diagonal direction.

See Figure 5 for details.

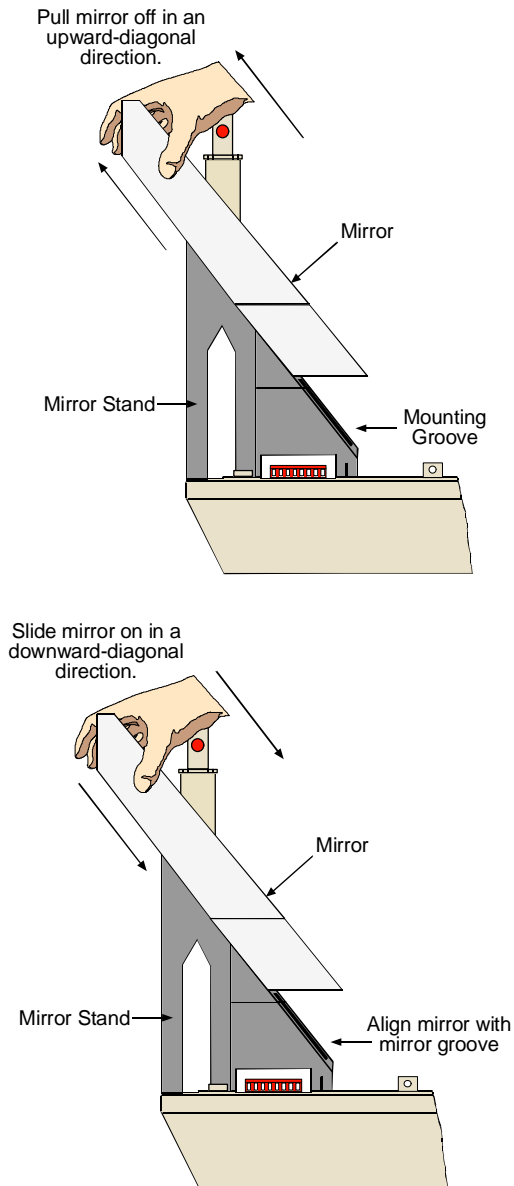

**Figure 5: Replacing the DS720i Mirror**

### 4.0 Wiring



**Only apply power after all connections have been made and inspected.**

Wire the terminal strip as shown in Figure 6.

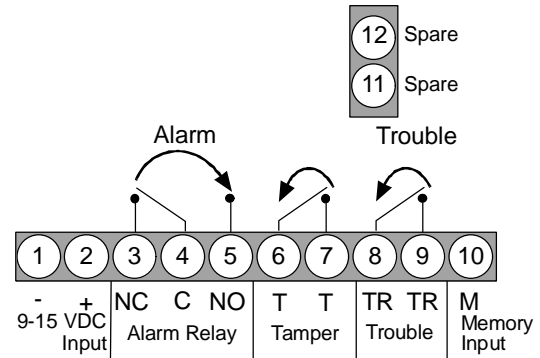

**Figure 6: Wiring the DS720i Terminals**

**Terminals 1(-) & 2(+):** Power limits are 9 to 15 VDC. Use no smaller than #22 AWG (0.8 mm) wire pair between the unit and the power source.

**Terminals 3, 4, & 5:** Alarm relay contacts rated 3 Watts, 125 mA, 28 VDC maximum for DC resistive loads and protected by a 4.7 ohm, 1/2 Watt resistor in the common "C" leg of the relay. Use terminals 3 & 4 for Normally Closed circuits. **Do not use with capacitive or inductive loads.**

**Terminals 6 & 7:** Tamper contacts rated at 28 VDC, 125 mA.

**Terminal 8 & 9:** Terminals are normally closed when the detector is not in trouble, and open when the detector is in trouble.

**Terminal 10:** Memory. Refer to Section 6.0 Feature Selection.

**Terminals 11 & 12:** Spare terminals.



**Seal any openings with the foam plugs provided to prevent drafts and insect entry. Use the (2) screws provided to secure the detector cover to the base.**

### 5.0 LED Operation

The DS720i uses three colors to indicate the various alarm and/or supervision trouble conditions that can exist. Refer to Table 1 for the colors and their respective conditions.

**Table 1: LED Functions**

LED	Function
Steady Red	Unit alarm or stored alarm
Steady Yellow	Intrusion detected by microwave section
Steady Green	Intrusion detected by PIR section
Flashing Red 1	Warm-up calibration period after initial power-up
Flashing Red 2	Motion Monitor time-out
Flashing Green 3	IR Anti-Mask failure
Flashing Yellow 3	Microwave Anti-Mask failure
Flashing Red 4	Microwave or PIR failure -- replace unit



**Flashing (color) 2-4: The LED flashes 2-4 times a cycle.**



The complete circuit operation of the PIR/ Microwave subsystems is checked every 5 hours. If the PIR or Microwave subsystems fail two consecutive times, the LED will flash red 4 times per cycle and the unit should be replaced. The detector will default to PIR technology protection if the Microwave subsystem fails. The PIR processing will automatically be adjusted to reduce false alarms. An intrusion alarm will reset most existing supervision trouble conditions. There must be at least 10 seconds of no activity (no alarm) prior to the detector alarm for a trouble clear to occur.

## 6.0 Feature Selection

The DS720i's features are selected using a bank of 8 DIP switches. See Figure 1 for a location of the DIP switches.

See Figure 7 for default DIP switch positioning.

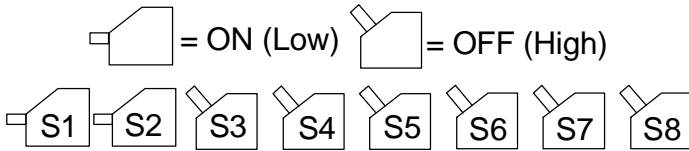

Figure 7: Default DIP Switch Positioning

The DS720i's features are assigned to the DIP switches as follows (factory-set default settings in parentheses):

- **S1:** LED Operation (ON)
- **S2:** PIR Sensitivity: OFF - High; ON - Intermediate (ON)
- **S3:** Motion Monitor: see Table 2 (OFF)
- **S4:** Motion Monitor: see Table 2 (OFF)
- **S5:** mW Anti-Mask (OFF)
- **S6:** Anti-Mask Delay Timer (OFF)
- **S7:** PIR Anti-Mask (OFF)
- **S8:** PIR Spray Detect (OFF)

**NOTE:** To activate the spray detection feature, both switches **S7** and **S8** must be in the ON position.

Table 2: Motion Monitor DIP Switch Settings

Motion Monitor	S3	S4
Disabled	OFF	OFF
1 Day	ON	OFF
4 Day	OFF	ON
30 Day	ON	ON

### 6.1 LED Operation

The ON position allows operation of the LED. If LED indication is not desired after setup and walk tests are completed, place in the OFF position. The OFF position does not prevent the LED from indicating supervision trouble conditions.

### 6.2 PIR Sensitivity Selection

**High Sensitivity (S2 OFF):** For fast response to intruder signals. This setting will improve your intruder catch performance.

**Intermediate Sensitivity (S2 ON):** Tolerates normal environments on this setting. This setting will improve your false alarm immunity.

### 6.3 Motion Monitor

To set the Motion Monitor feature, refer to Table 2 for switches S3 and S4. The Motion Monitor Supervision feature verifies that each technology has a clear view of the detection area. When selected, a supervision timer is activated which gives the detector the ability to indicate a supervision trouble condition if the time period has elapsed since the last detector alarm. If the Memory feature is used, the motion monitor time period will be increased by the amount of time the detector is in the arm condition. If the detector does not detect an alarm within the selected time period, the LED will flash red 2 times to indicate a Motion Monitor Time-out condition and the Trouble output will activate.

### 6.4 Anti-Mask/Spray Detection

The Anti-Mask feature detects attempts made to disable the detector by covering it. The DS720i has Microwave Anti-Mask, IR Anti-Mask and Spray Anti-Mask as standard features. When activated, the detector will indicate an Anti-Mask supervision trouble condition if a microwave reflective material (e.g. metal, most plastics, etc.) is placed within one foot of the detector.



The anti-masking feature may interpret removal and/or replacement of the cover as an attempt to mask the detector and may signal a supervision trouble condition. If this should occur, reset the detector by removing and then reapplying its power. The trouble condition will also be reset by the next detector alarm after a 10 second period of no alarms from both technologies.

This anti-mask feature also has a delay timer function that can be turned ON or OFF with the selection of switch S6. When enabled (switch S6 ON), this feature evaluates the anti-mask condition for false alarms. For maximum anti-mask/spray detection performance, this timer should be turned OFF.

The Spray Detection feature prevents accidental or intentional blocking of the detector by detecting an object placed in close proximity of the detector, or if the detector is sprayed with a foreign substance. See Figure 8 for details.

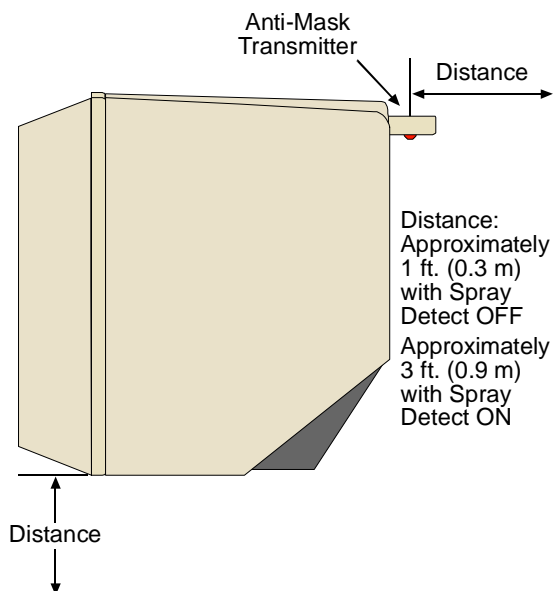

Figure 8: Anti-Mask/Spray Detection Coverage

## 6.5 Memory Operation

Memory, Armed Mode and Walk Test require a supply voltage on Terminal 10 to activate these features. This supply voltage must be between 6 and 18 VDC. You may use a switch as shown in Figure 9:

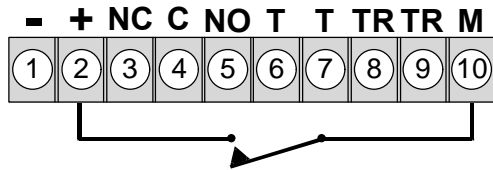

Figure 9: Alarm Memory Function

Or use an external power supply as shown in Figure 10:

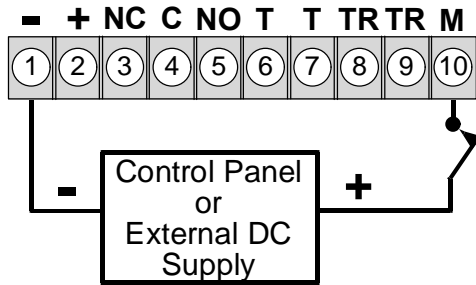

Figure 10: Alarm Memory Function with External Power Supply

Control voltage: +6 to +18 volts = ON (Switch Closed); 0 volts = OFF (Switch Open).

**Day Mode:** The Day Mode disables the alarm memory and allows the LED (if activated) to operate normally.

**Memory:** When the DS720i is in the Night Mode the memory is activated. This allows the detector to store an alarm for display at a later time.

**Armed Mode:** The Night Mode enables the alarm memory and disables the LED operation.

**Remote Walk Test (LED Control):** When the DS720i is in the Walk Test mode, the LED will indicate the current alarm status regardless of the setting of the LED Operation switch (Switch 1).

Table 2: Memory Operation Settings

Desired Action	Control Voltage (Terminal M)
Turn ON Night Mode/ Reset Stored Alarm	ON (for more than 20 seconds)
Turn OFF Night Mode/ Display Stored Alarm	OFF
Turn ON Walk Test (if OFF)	ON (for more than 5 seconds, but less than 20 seconds)
Turn OFF Walk Test (if ON)	ON (for more than 1 second, but less than 20 seconds)

## 7.0 Setup and Walk Tests

Place the LED switch in the ON position. If using the Memory Input to enable the Remote Walk Test feature, it is not necessary to put the LED switch in the ON position.

**NOTE:** Use a bubble level on the front of the unit to check for proper positioning and alignment.

### 7.1 Establishing PIR Pattern Coverage

Turn the Microwave Range Adjust to minimum.

Replace the cover and snap it into place. This will close the tamper switch.



**During the warm-up period, the LED will flash red until the unit has stabilized and has seen no movement for 2 seconds (approximately 1 to 2 minutes). When the LED stops flashing, the detector is ready to be tested. With no motion in the protection area, the LED should be OFF. If the LED is ON, recheck the protection area for disturbances affecting the microwave or PIR technologies.**

Walk test **across** the pattern at its farthest edge, then several times closer to the detector. Start walking from outside of the intended protection area, and observe the LED. The edge of the pattern is determined by the first green, PIR activation of the LED (or the first red activation if the yellow microwave LED activates first).

If the desired coverage cannot be achieved, try angling the coverage pattern up or down to ensure the pattern is not aimed too high or low. In a narrow aisleway, aiming the pattern slightly left or right can also improve the detector's catch performance.

### 7.2 Establishing Microwave Coverage



**Wait 1 minute after removing/replacing the cover so the microwave portion of the detector can settle and to wait at least 10 seconds between the following walk testing procedures.**

The LED should be OFF before walk testing.

Walk test **across** the pattern at the intended coverage's **farthest** end. Start walking from outside the intended protection area and observe the LED. The edge of the microwave pattern is determined by the first activation of the yellow LED.

If an adequate range cannot be reached, increase the Microwave Range Adjust slightly. Continue walk testing (waiting 1 minute after removing/replacing the cover) and adjusting the range until the farthest edge of desired coverage has been accurately placed.



**Do not adjust the Microwave Range higher than required. Doing so will enable the detector to catch movement outside of the intended coverage pattern.**

Walk test the unit from all directions to determine all the detection pattern boundaries. Wait at least 10 seconds between walk tests.

### 7.3 Establishing Detector Coverage

All LEDs should be OFF before walk testing.

Walk test the unit from all directions to determine the detection boundaries. A detector alarm is signaled by the first red activation of the LED after an initial green or yellow LED activation.

## 8.0 Meter Tests

An analog or digital volt meter is recommended. Use of the TC6000 is recommended, but is not essential for meter use. Either outside connector pin of the TC6000 may be used as common (-).

### 8.1 PIR Meter Readings

Connect the meter to the PIR Noise Voltage Pins. With no target motion in the pattern, read the voltage. The base reference level for PIR background is approximately 1.0 VDC. Installations in quiet environments, therefore, should result in a steady meter reading between 0.9 and 1.1 VDC.

Walk test **across** the farthest edge of the coverage pattern. Make sure the detector's cover is on.

Voltage changes greater than +0.75 VDC from the reference level during walk tests **are desirable**. If changes are less than 0.75 VDC, the detector may fail to respond at this far a distance if the temperature difference between the intruder and the background is minimal. Try adjusting the unit up and down to maximize the voltage change during walk tests.

Turn on all heating/cooling sources that will be in operation during the times of protection. Stand away from the unit and outside the protection pattern, then monitor background noise for at least 3 minutes.

Readings should not deviate more than 0.15 VDC from the reference level. If they do, eliminate the cause or reposition the pattern (observe readings while turning on and turning off these sources as well as during the three minute interval).

### 8.2 Microwave Meter Readings

Connect the meter to the Microwave (mW) Noise Voltage Pins.

With no target motion in the pattern, read the voltage. The background noise voltage should be steady, and should not exceed 1.0 VDC. If it does, the cause of the disturbance should be found and eliminated.



IMPORTANT

**Microwaves penetrate nonmetallic surfaces. Movement on the other side of walls and doors viewed by the detector could cause unexpected background noise readings.**

## 9.0 Other Information

### 9.1 Maintenance

At least once a year, the range and coverage should be verified. To ensure continual daily operation, the end user should be instructed to walk through the far end of the coverage pattern. This ensures an alarm output prior to arming the system.

### 9.2 Pattern Masking

Refer to the mirror module and pattern drawings in Section 10.0 for masking.



IMPORTANT

**Many adhesives will either destroy the mirror surface or leave enough surface residue behind to reduce coverage performance. Be sure to clean the mirror surface with a mild window cleaning solution after masking removal.**

### 9.3 FCC Compliance Notice

This device complies with Part 15 of the FCC Rules and with RSS-210 of Industry and Science Canada. Operation is subject to the following two conditions: (1) this device may not cause harmful interference, and (2) this device must accept any interference that may cause undesirable operation.

## 10.0 Coverage Patterns

The protected coverage area is where the microwave and PIR patterns overlap.

OA300 Long Range Coverage (pre-installed)

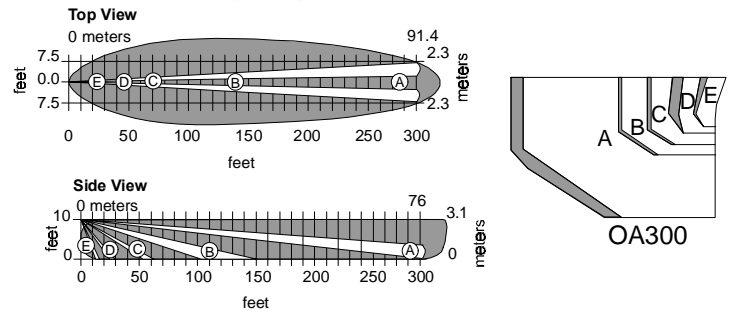

OA90 Standard Broad Coverage (optional mirror - included)

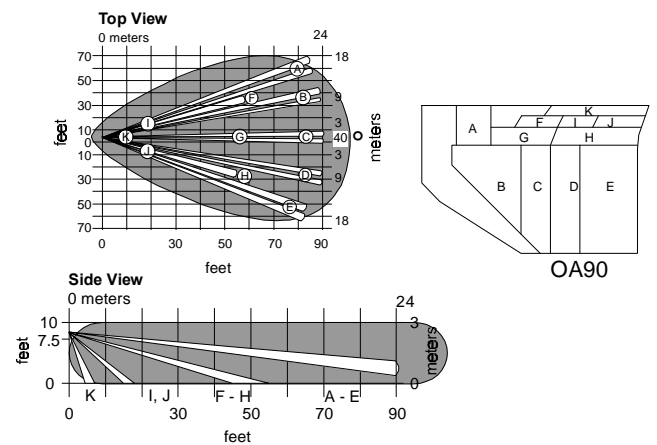

OA120 Long Range Coverage (Optional)

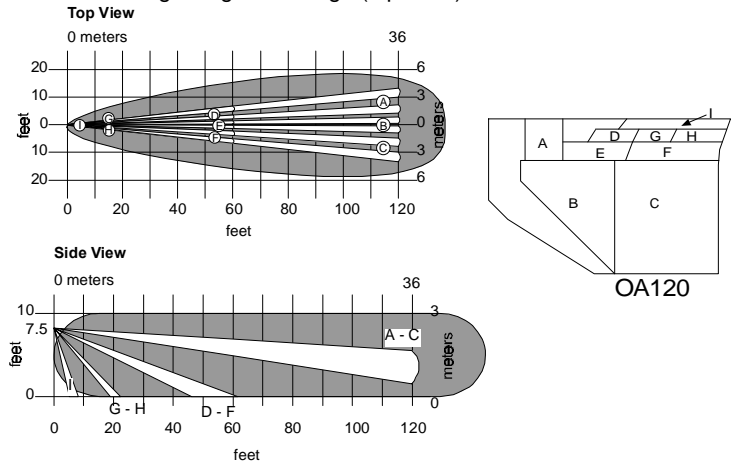

**NOTE:** Use a bubble level on the front of the unit to check for proper positioning and alignment.