



Plena

Voice Alarm System



BOSCH

en Installation and Operation manual

Table of contents

1	Safety	8
1.1	Important Safeguards	8
1.2	Important Notices	8
2	About this manual	9
2.1	Purpose of this manual	9
2.2	Intended audience	9
2.3	Related documentation	9
2.4	Alerts and notice signs	9
2.5	Conversion tables	10
2.6	Nomenclature	11
2.7	Document history	11
3	System overview	12
3.1	Voice Alarm System	12
3.1.1	Application types	12
3.1.2	Application areas	12
3.1.3	Plena	12
3.1.4	Praesideo	12
3.2	Voice Alarm Controller	13
3.2.1	Hand-held microphone	13
3.2.2	Internal power amplifier	13
3.2.3	Internal message manager	13
3.2.4	Supervision	13
3.2.5	Trigger inputs	13
3.2.6	Remote control	14
3.2.7	Controls, connectors and indicators	14
3.3	Voice Alarm Router	18
3.3.1	Loudspeaker zones	18
3.3.2	Trigger inputs	18
3.3.3	External power amplifiers	18
3.3.4	Remote control	18
3.3.5	Controls, connectors and indicators	19
3.4	Call Station	21
3.4.1	Buttons	21
3.4.2	Supervision	21
3.4.3	Keypad	22
3.4.4	Controls, connectors and indicators	23
3.5	Call Station Keypad	24
3.6	Voice Alarm Remote Control	25
3.7	Voice Alarm Remote Control kit	27
3.8	Remote Control Extension	28
3.9	Remote Control Extension kit	29
3.10	Fireman's Panel	30
3.11	End Of Line detection board	32
3.12	Application examples	32
3.12.1	Schools	32
3.12.2	Swimming pool	35
3.12.3	Shopping mall	37

3.12.4	Hotel	40
3.13	Calls and priorities	42
3.13.1	Priority	42
3.13.2	Mergeable messages	42
3.13.3	Business call	42
3.13.4	Emergency call	42
4	Installation	43
4.1	Voice Alarm Controller	43
4.2	Voice Alarm Router	43
4.3	Call Station Keypad	44
4.4	Voice Alarm Remote Control	44
4.5	Voice Alarm Remote Control Kit	44
4.6	Remote Control Extension	45
4.7	Remote Control Extension Kit	45
4.8	End Of Line detection board	45
4.8.1	Installation of a single EOL	46
4.8.2	Installation of a multiple EOL in a daisy-chain	46
4.9	Dummy load	48
4.9.1	Set the jumper JP1 on the Dummy load	48
5	Connection	49
5.1	Voice Alarm Controller	49
5.1.1	Emergency microphone	49
5.1.2	Call station	50
5.1.3	Voice alarm routers	51
5.1.4	External power amplifier	52
5.1.5	Remote controls	53
5.1.6	Loudspeakers	54
5.1.7	Volume overrides	56
5.1.8	Line output	58
5.1.9	Mic/line input with VOX	59
5.1.10	BGM inputs	60
5.1.11	Status output contacts	61
5.1.12	Power	62
5.1.13	Trigger inputs	64
5.2	Voice Alarm Router	66
5.2.1	Voice alarm controller	66
5.2.2	Loudspeakers	66
5.2.3	Volume overrides	66
5.2.4	Trigger inputs	66
5.2.5	External power amplifiers	67
5.2.6	Power	68
5.3	Call Station	69
5.3.1	Voice alarm controller	69
5.3.2	Power supply	69
5.3.3	Keypads	69
5.4	Voice Alarm Remote Control	70
5.4.1	Voice alarm controller	70
5.4.2	Remote control extensions	70
5.4.3	Status output contacts	70

5.4.4	Power	71
5.5	Voice Alarm Remote Control Kit	71
5.5.1	Rear panel	71
5.5.2	LEDs	71
5.5.3	Lamps	72
5.5.4	Relays	72
5.6	Remote Control Extension	73
5.6.1	Remote control	73
5.6.2	Status output contacts	73
5.6.3	Power	73
5.7	Remote Control Extension Kit	73
5.7.1	Rear panel	73
5.7.2	LEDs	73
5.7.3	Lamps	73
5.7.4	Relays	74
5.8	Fireman's Panel	74
5.8.1	Voice alarm controller	74
5.8.2	Remote control extensions	74
5.8.3	Status output contacts	74
5.8.4	Power	74
6	Configuration	75
6.1	System settings	75
6.1.1	Monitor	76
6.1.2	APR mode	76
6.1.3	Supervision	76
6.1.4	1-Channel mode operation	77
6.1.5	2-Channel mode operation	78
6.2	Supervision	78
6.2.1	Processor reset	79
6.2.2	Network	79
6.2.3	Power amplifiers	79
6.2.4	Ground short	79
6.2.5	Emergency trigger inputs	80
6.2.6	Mains power	80
6.2.7	Battery	80
6.2.8	Message supervision	80
6.2.9	Emergency microphone	80
6.2.10	Line supervision	80
6.3	Voice alarm controller	81
6.3.1	VOX configuration	81
6.3.2	VOX	82
6.3.3	Speech filter	82
6.3.4	Phantom power	82
6.3.5	Voice alarm router	82
6.3.6	Router ID	82
6.3.7	Termination switch	82
6.4	Call station	83
6.4.1	Call station ID	83
6.4.2	Sensitivity	83

6.4.3	Speech filter	84
6.4.4	Termination	84
6.5	Remote control	85
6.5.1	Remote control ID	85
6.5.2	Monitor	85
6.5.3	Termination switch	85
6.6	Remote control extension	86
6.6.1	Remote control extension ID	86
6.6.2	Termination switch	86
7	Operation	87
7.1	Switch on	87
7.1.1	Voice alarm controller	87
7.1.2	Voice alarm router	87
7.1.3	Calibration	87
7.2	Background music	88
7.2.1	Select BGM source	88
7.2.2	Select zones	88
7.2.3	Adjust volume	89
7.2.4	Adjust frequencies	89
7.3	Business calls	89
7.3.1	Select zones	90
7.3.2	Make the announcement	90
7.4	Emergency state	91
7.4.1	Enter the emergency state	91
7.4.2	Acknowledge the emergency state	92
7.4.3	Exit the emergency state	92
7.4.4	Distribute live speech	92
7.4.5	Select zones	93
7.4.6	Make the announcement	94
7.4.7	Distribute the alert message	94
7.4.8	Distribute the alarm message	96
7.5	Fault State	96
7.5.1	Acknowledge the fault state	96
7.5.2	Reset the fault state	97
7.5.3	Fault indicators	98
8	Troubleshooting	101
8.1	Introduction	101
8.2	Message or chime does not sound	101
8.3	No pilot tone detected on EOL board	101
8.4	No pilot tone detected on power amplifier	101
8.5	No BGM on the router	101
8.6	No BGM on controller or router	101
8.7	No sound coming from the router	102
8.8	Volume override only working for EMG, not for business calls (or similar problems)	102
8.9	False Ground Short fault	102
8.10	Start/Stop function on Trigger Inputs	102
8.11	Processor Reset	103
8.12	USB port not connected	103
8.13	Data fault during configuration upload	103

8.14	A click sounds through the loudspeakers at regular intervals	103
8.15	Password not working	103
8.16	Configuration download fails	103
8.17	Can't retrieve the original wave files with the configuration download	104
9	Maintenance	105
9.1	Clean the units	105
9.2	Clean air inlets	105
9.3	Check the connectors and grounding	105
10	Technical data	106
10.1	Electrical	106
10.1.1	Voice Alarm Controller	106
10.1.2	Voice Alarm Router	109
10.1.3	Call Station	110
10.2	Physical characteristics	110
10.2.1	Voice Alarm Controller	110
10.2.2	Voice Alarm Router	111
10.2.3	Call Station	111
10.2.4	Call Station Keypad	111
10.2.5	Voice Alarm Remote Control	111
10.2.6	Voice Alarm Remote Control Kit	111
10.2.7	Remote Control Extension	111
10.2.8	Remote Control Extension Kit	111
10.2.9	Fireman's Panel	112
10.2.10	End of line detection board	112
10.3	Environmental conditions	112
10.3.1	Voice Alarm Controller	112
10.3.2	Voice Alarm Router	112
10.3.3	Call Station	112
10.4	Standards	113
10.4.1	Voice Alarm Controller	113
11	Appendices	114
11.1	Compliance checklists	114
11.1.1	Emergency Sound Systems	114
11.1.2	EN60849: 1998	116
11.1.3	EN60849 - When using the Remote Control Kits:	135
11.1.4	EN54-16	136

1 Safety

1.1 Important Safeguards

Prior to installing or operating products, always read the Important Safety Instructions which are available as a separate multilingual document: Important Safety Instructions (Safety_ML). These instructions are supplied together with all equipment that can be connected to the mains supply.

1.2 Important Notices

When using routers, keypads or more than one call station, configure the controller using the supplied software.

Use shielded cable (CAT-5) between the routers and the controller.

The factory default setting of the Plena Voice Alarm System Controller is as follows:

- One channel system.
- Supervision off.
- Please read the latest release notes for the version of the hardware and software you are using. With firmware (e.g. 3.01.01), the first digit is a major release, where backward compatibility is not guaranteed, second digits are changes in functionality that are backward compatible, the last digits are for bug fixes without impact on functionality. Lastly, the PC configuration software may have an Rx suffix, that indicates changes to the PC configuration software without changes to firmware.

2 About this manual

2.1 Purpose of this manual

The purpose of the Installation and Operation manual is to provide information that is required to install, configure and operate a Plena Voice Alarm System.

2.2 Intended audience

The Installation and Operation manual is intended for installers and users of an (extensive) Plena Voice Alarm System.

2.3 Related documentation

The following related document is available:

- Plena Voice Alarm System Configuration Software Manual.
- Refer to the product related information on www.boschsecurity.com.

2.4 Alerts and notice signs

Four types of signs can be used in this manual. The type is closely related to the effect that may be caused if it is not observed. These signs - from least severe effect to most severe effect - are:

**Notice!**

Containing additional information. Usually, not observing a 'notice' does not result in damage to the equipment or personal injuries.

**Caution!**

The equipment or the property can be damaged, or persons can be lightly injured if the alert is not observed.

**Warning!**

The equipment or the property can be seriously damaged, or persons can be severely injured if the alert is not observed.

**Danger!**

Not observing the alert can lead to severe injuries or death.

2.5 Conversion tables

In this manual, SI units are used to express lengths, masses, temperatures etc. These can be converted to non-metric units using the information provided below.

1 in =	25.4 mm	1 mm =	0.03937 in
1 in =	2.54 cm	1 cm =	0.3937 in
1 ft =	0.3048 m	1 m =	3.281 ft
1 mi =	1.609 km	1 km =	0.622 mi

Table 2.1: Conversion of units of length

1 lb =	0.4536 kg	1 kg =	2.2046 lb
--------	-----------	--------	-----------

Table 2.2: Conversion of units of mass

1 psi =	68.95 hPa	1 hPa =	0.0145 psi
---------	-----------	---------	------------

Table 2.3: Conversion of units of pressure



Notice!

1 hPa = 1 mbar

$$^{\circ}\text{F} = \frac{9}{5} \cdot ^{\circ}\text{C} + 32$$

$$^{\circ}\text{C} = \frac{5}{9} \cdot (^{\circ}\text{F} - 32)$$

2.6 Nomenclature

Throughout this manual, terms like “Controller”, “Router” and “Remote Control” are used to describe the various component types, as indicated below.

Component description	Component type designation
Power Amplifier 360/240W	LBB 1935/20
Power Amplifier 720/480W	LBB 1938/20
Call Station	LBB 1956/00
Call Station Keypad	LBB 1957/00
Controller	LBB 1990/00
Router	LBB 1992/00
Fireman's panel	LBB 1995/00
Remote Control	LBB 1996/00
Remote Control Extension	LBB 1997/00
Loop Amplifier	PLN-1LA10
Dummy load	PLN-DMY60
End-of-Line board	PLN-1EOL

Table 2.4: Component description and type designation

Component description	Component type designation
Remote Control kit	LBB1998/00
Remote Control Extension kit	LBB1999/00
Power Amplifier 720/480W	PLN-1P1000
Surge and transients suppression board	PM1-6SP

Table 2.5: Component description and type designation

2.7 Document history

Release date	Documentation version	Reason
2013.07.07	V2.0	– 2 nd edition

3 System overview

3.1 Voice Alarm System

The Plena Voice Alarm System is a public address and voice alarm system in which features for compliance to evacuation standards such as EN60849, NEN2575, BS5839/8 and EN54-16 are integrated.

3.1.1 Application types

Typically, the Plena Voice Alarm System is used to create small systems that must comply to evacuation standards, medium-sized systems in which one call channel is enough and large systems that consist of many small zones.

3.1.2 Application areas

The application areas of the Plena Voice Alarm System include:

- Supermarkets, shops
- Factories
- High-rise buildings
- Office buildings
- Schools
- Recreational facilities
- Hotels
- Small airports

3.1.3 Plena

The Plena Voice Alarm System is part of the Plena product range. Plena provides public address solutions for places where people gather to work, worship, trade or simply enjoy themselves. It is a family of system elements that are combined to create public address systems tailored for virtually any application. The range includes mixer, pre, system and power amplifiers, a source unit, digital message manager, feedback suppressor, conventional and PC call stations, an 'All-in-One' system, an audio interface, a timer, a charger, a loop amplifier, a BGM source and a voice alarm system. Each element is designed to complement all others thanks to matched acoustical, electrical and mechanical specifications.

3.1.4 Praesideo

It is possible to combine the Plena Voice Alarm System with e.g. a Praesideo digital public address and emergency sound system, or a Promatrix or other system. When an audio output of Praesideo is connected to a VOX audio input of the Plena Voice Alarm System, calls that are made by the Praesideo system overrule the calls that are made with the Plena Voice Alarm System.

3.2 Voice Alarm Controller

The Voice Alarm Controller is the heart of the Plena Voice Alarm System. The voice alarm controller distributes emergency calls, business calls as well as background music (BGM) to up to 6 loudspeaker zones.



Figure 3.1: Voice Alarm Controller



Notice!

When the voice alarm controller has been purchased in the Asian-Pacific Region, the emergency button has a different cover.

3.2.1 Hand-held microphone

The voice alarm controller is equipped with a hand-held microphone, which can be used to make emergency calls.

3.2.2 Internal power amplifier

The voice alarm controller has a 240 W internal power amplifier, which can be used in 1-channel or 2-channel mode. In the 1-channel mode, all calls and BGM are amplified by the internal power amplifier. If desired, an external power amplifier can be connected for spare switching. In the 2-channel mode, the BGM is amplified by the internal power amplifier, whereas the calls are amplified by an external power amplifier.

3.2.3 Internal message manager

The voice alarm controller has an internal message manager, which maps wave files (.wav) to messages that can be played by the Plena Voice Alarm System.

3.2.4 Supervision

All necessary supervision features for compliance to evacuation standards are integrated into the voice alarm controller. If supervision is enabled and a fault is detected, the voice alarm controller lights a LED on its front panel that indicates the cause of the fault.

3.2.5 Trigger inputs

The voice alarm controller has a terminal block to which 6 emergency (EMG) and 6 business trigger inputs can be connected. Third party systems can use the trigger inputs to start emergency and business calls in the Plena Voice Alarm System.

3.2.6 Remote control

With the Voice Alarm Remote Control, it is possible to control the voice alarm controller from another site. The remote control is also available as kit (Voice Alarm Remote Control Kit) for creating customized solutions. The maximum number of remote controls that can be connected to the voice alarm controller is 2. A special type of remote control is the Fireman's Panel.

3.2.7 Controls, connectors and indicators

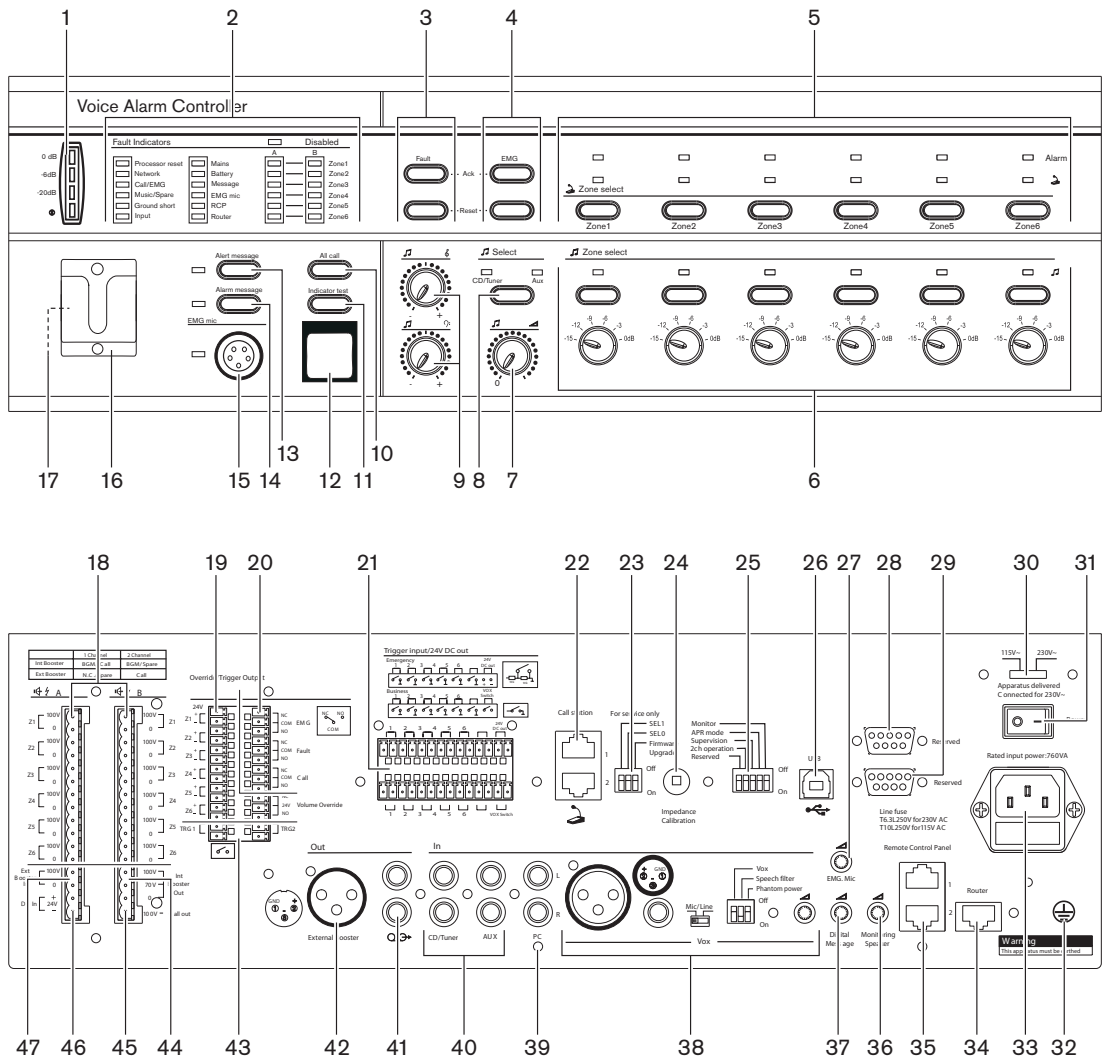

Figure 3.2: Front and rear views of the voice alarm controller

Controls, connectors and indicators on the voice alarm controller:

1. Power LED/VU Meter:

A combined power indicator and VU meter. The green power LED is lit if the voice alarm controller is connected to the mains or back-up power and switched on. The VU meter indicates the master VU level: 0 dB (red), 6 dB, -20 dB (yellow).

Notice: As the pilot-tone level of the VAS is -20 dB or -23 dB in some amplifiers, the -20 dB LED will be on continuously. This is normal.

2. **Fault indicators:**

Twelve yellow system fault LEDs (Processor reset, Network, Call/EMG, Music/Spare, Ground short, Input, Mains, Battery, Message, EMG mic, RCP and Router) and twelve yellow loudspeaker line fault LEDs. Fault indication is only possible if supervision is enabled (see section *Fault indicators, page 98*). If supervision is disabled, the yellow Disabled LED is lit.
3. **Fault state buttons:**

Two buttons to acknowledge (Ack) and reset (Reset) the fault state (see section *Fault State, page 96*).
4. **Emergency state buttons:**

Two buttons to acknowledge (Ack) and reset (Reset) the emergency state (see section *Emergency state, page 91*).
5. **Emergency call zone selectors:**

Six buttons to select the zones to which the emergency call must be distributed (see section *Emergency state, page 91*). Each button has a green and a red LED. The six red LEDs indicate the zones that are selected for the emergency call. The six green LEDs indicate the zones in which a business call is running.
6. **BGM zone selectors:**

Six buttons to select the zones to which the BGM is distributed (see section *Background music, page 88*). Each button has a green LED and a rotary knob. The six green LEDs indicate the zones to which BGM is distributed. The six rotary knobs are local volume controls that can be used to adjust the volume of the BGM in each zone. Each volume control knob has six settings.
7. **BGM master volume control:**

A rotary knob to set the master volume of the BGM (see section *Background music, page 88*).
8. **BGM source selector:**

A button to select the BGM source (CD/Tuner or Aux). The selected source is indicated with a green LED (see section *Background music, page 88*).
9. **BGM tone controls:**

Two rotary knobs to control the high and low frequencies of the BGM (see section *Background music, page 88*).
10. **All call button:**

A button to select all zones. This button is only available in the emergency state (see section *Emergency state, page 91*).
11. **Indicator test button:**

A button to test all LEDs on the front panel of the voice alarm controller, and connected voice alarm routers, remote control panels, remote control extensions and fireman's panels. All LEDs are lit as long as the button is pushed (see section *Fault State, page 96*).
12. **Emergency button:**

A push button to put the system in the emergency state (see section *Emergency state, page 91*).
13. **Alert message button:**

A button to select the alert message. This button is only available in the emergency state (see section *Emergency state, page 91*).
14. **Alarm message button:**

A button to select the default alarm message. This button is only available in the emergency state (see section *Emergency state, page 91*).

15. **Microphone socket:**
A socket to connect the hand-held emergency microphone (see section *Emergency microphone*, page 49).
16. **Bracket:**
A bracket for the hand-held emergency microphone that is supplied with the voice alarm controller.
17. **Monitoring speaker:**
Built-in monitoring speaker.
18. **Zone outputs:**
Six zone outputs to connect loudspeakers to the voice alarm controller. Each zone output consists of two loudspeaker line outputs (see section *Loudspeakers*, page 54).
19. **Override outputs:**
Six volume override outputs to override local volume controls in each zone (see section *Volume overrides*, page 56).
20. **Status outputs:**
Three status outputs to send the status of the Plena Voice Alarm System to third party equipment (see section *Status output contacts*, page 61).
21. **Trigger inputs/24 V DC output:**
Twelve trigger inputs to receive signals from third party equipment and one 24 V(DC) output (see section *Trigger inputs*, page 64).
22. **Call station sockets:**
Two RJ45 sockets to connect call stations to the voice alarm controller (see section *Call station*, page 50).
23. **Service settings:**
A set of DIP switches to service the voice alarm controller. Do not change the positions of the switches.
24. **Calibration switch:**
A switch to calibrate the impedances of the loudspeaker lines for loudspeaker supervision (see section *Calibration*, page 87).
25. **Configuration settings:**
A set of DIP switches to configure the system (see section *System settings*, page 75).
26. **PC socket:**
A USB socket to connect the voice alarm controller to a PC.
Refer to the Configuration Software Manual for more information about connecting a PC to the voice alarm controller.
27. **Emergency microphone volume control:**
A rotary knob to set the volume of the hand-held emergency microphone.
28. **Reserved.**
29. **Reserved:**
To connect an OI, or for upgrades (only for authorized use).
30. **Voltage selector:**
A voltage selector to select the local mains voltage (see section *Power*, page 62).
31. **Power switch:**
A switch to switch the voice alarm controller on and off (see section *Power*, page 62).
32. **Ground:**
A connection to electrically ground the voice alarm controller.
33. **Mains power inlet:**
A socket to connect the voice alarm controller to the mains power (see section *Power*, page 62).

34. **Router socket:**
An RJ45 socket to connect voice alarm routers to the voice alarm controller (see section *Voice alarm routers*, page 51).
35. **Remote control panel socket:**
Two RJ45 sockets to connect remote control panels (Fireman's panel, Remote Control, Remote Control kit) to the voice alarm controller.
36. **Monitoring speaker volume control:**
A rotary knob to set the volume of the monitoring loudspeaker.
37. **Digital message volume control:**
A rotary knob to set the volume of the digital messages. This volume control does not influence the volume of the emergency messages.
38. **Mic/line input with VOX functionality:**
An XLR socket and a 6.3 mm jack with voice-activated (VOX) functionality to connect a microphone or line input to the voice alarm controller (see section *Mic/line input with VOX*, page 59). The VOX settings are configured with the DIP switches and the source switch (see section *VOX configuration*, page 81).
39. **PC Call station input:**
An input to connect a PC call station. For future use.
40. **BGM inputs:**
Two inputs to connect background music sources. Each input consists of two cinch sockets (see section *BGM inputs*, page 60).
41. **Line output:**
A line output to connect an external recording device to record the audio of the Plena Voice Alarm System (see section *Line output*, page 58).
42. **External power amplifier (output):**
An XLR socket to connect an external power amplifier (see section *External power amplifier*, page 52). This socket is used in combination with the external power amplifier input (no. 47).
43. **Trigger outputs:**
Two general purpose trigger outputs. For future use. TR1 is active during impedance check.
44. **Internal power amplifier output:**
Three pins that provide the 100 V audio signal of the internal power amplifier of the voice alarm controller. Also includes a 70 V connection.
45. **Call output:**
An output that provides the call audio of the Plena Voice Alarm System.
46. **Back-up power inlet:**
An inlet to connect a back-up power supply to the voice alarm controller (see section *Power*, page 62).
47. **External power amplifier (input):**
An input to connect an external power amplifier (see section *External power amplifier*, page 52). These pins are used in combination with the external power amplifier output (no. 42).

3.3 Voice Alarm Router

With the Voice Alarm Router, the number of loudspeaker zones and trigger inputs in the system can be increased.



Figure 3.3: Voice alarm router

3.3.1 Loudspeaker zones

A voice alarm controller can serve and manage 6 loudspeaker zones. To increase the number of zones in the system, one or more Voice Alarm Routers can be connected to the voice alarm controller. Each router adds a maximum of 6 zones to the system. As the maximum number of voice alarm routers that can be connected in a system is 19, the maximum number of zones in a Plena Voice Alarm System is 120 (from hardware and software version 3.x onwards).



Notice!

If older routers are used (version 2.x or higher), 60 zones can be addressed. The recommendation is to always use 3.x hardware in combination with each other.

3.3.2 Trigger inputs

A voice alarm controller can manage 6 emergency (EMG) and 6 business trigger inputs. To increase the number of EMG and trigger inputs, one or more voice alarm routers can be connected to the voice alarm controller. Each router adds a maximum of 6 EMG trigger inputs and 6 business trigger inputs to the system. As the maximum number of voice alarm routers that can be connected in a system is 19, the maximum number of EMG trigger inputs in a Plena Voice Alarm System is 120 (from hardware and software version 3.x onwards). The maximum number of business trigger inputs in a Plena Voice Alarm System is also 120 (from hardware and software version 3.x onwards).



Notice!

If older routers are used (version 2.x or higher), 60 zones can be addressed. The recommendation is to always use 3.x hardware in combination with each other.

3.3.3 External power amplifiers

The voice alarm router does not have an internal power amplifier. When the power that is supplied by the voice alarm controller is insufficient, to each voice alarm router two external power amplifiers can be connected. In a multi-router system, multiple power amplifiers can be connected to amplify calls and background music (BGM) or just for backup purposes.

3.3.4 Remote control

With the Voice Alarm Remote Control Extension, it is possible to control the voice alarm router from another location. The remote control extension is also available as a kit (Voice Alarm Remote Extension Kit) for creating customized solutions.

3.3.5 Controls, connectors and indicators

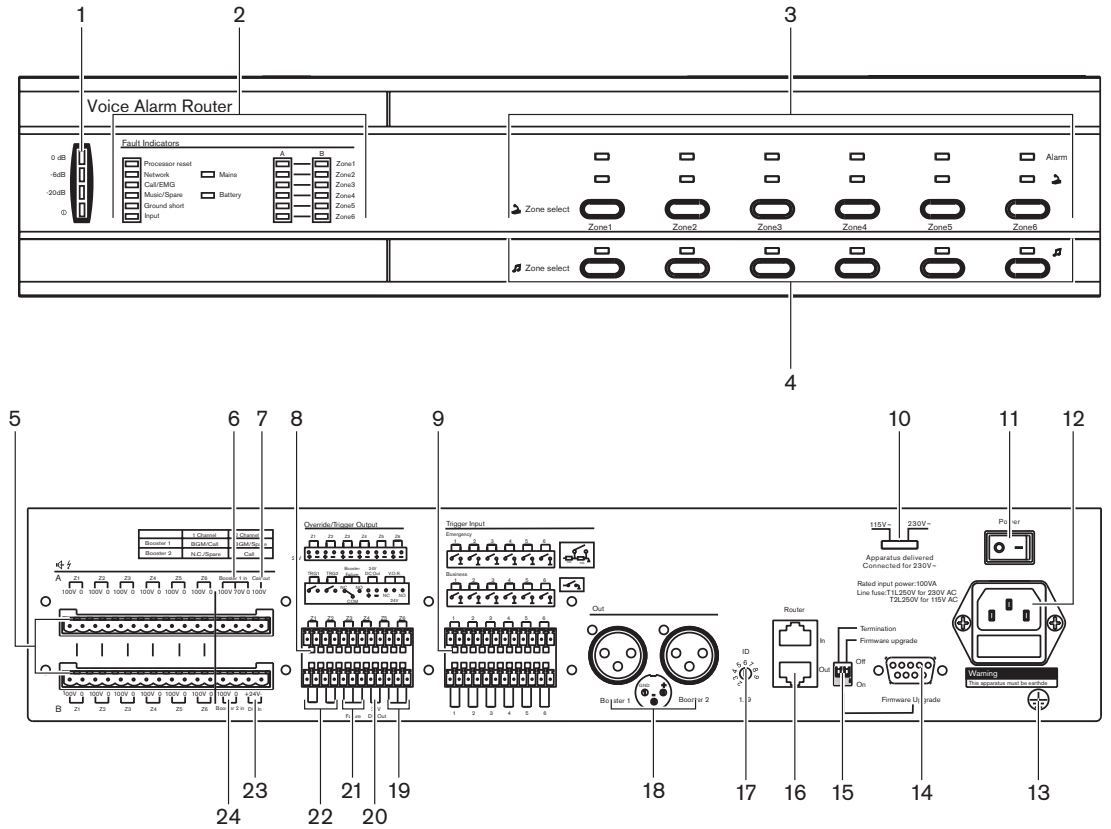

Figure 3.4: Front and rear views of the voice alarm router

Controls, indicators and connectors on the voice alarm router:

1. **Power LED/VU Meter:**
A combined power indicator and VU meter. The green power LED is lit if the voice alarm router is connected to the mains or back-up power and switched on. The VU meter indicates the master VU level: 0 dB (red), -6 dB, -20 dB (yellow).
2. **Fault indicators:**
Eight yellow system fault LEDs (Processor reset, Network, Call/EMG, Music/Spare, Ground short, Input, Mains, Battery) and twelve yellow loudspeaker line fault LEDs. Fault indication is only possible if supervision is enabled (see section *Fault indicators*, page 98).
3. **Emergency call zone selectors:**
Six buttons to select the zones to which the emergency call must be distributed (see section *Emergency state*, page 91). Each button has a green and a red LED. The six red LEDs indicate the zones that are selected for the emergency call. The six green LEDs indicate the zones in which a business call is running.
4. **BGM zone selectors:**
Six buttons to select the zones to which the BGM is distributed (see section *Background music*, page 88). Each button has a green LED. The six green LEDs indicate the zones to which BGM is distributed.
5. **Zone outputs:**
Six zone outputs to connect loudspeakers to the voice alarm router. Each zone output consists of two loudspeaker line outputs (see section *Loudspeakers*, page 66).

6. **External power amplifier 1 (input):**
An input to connect an external power amplifier (see section *External power amplifiers*, page 67). These pins are used in combination with the external power amplifier output (no. 18).
7. **Call output:**
An output that provides the call audio of the Plena Voice Alarm System.
8. **Override outputs:**
Six volume override outputs to override local volume controls in each zone (see section *Volume overrides*, page 66).
9. **Trigger inputs:**
Twelve trigger inputs to receive signals from third party equipment (see section *Trigger inputs*, page 66).
10. **Voltage selector:**
A voltage selector to select the local mains voltage (see section *Power*, page 68).
11. **Power switch:**
A switch to switch the voice alarm router on and off (see section *Power*, page 68).
12. **Mains power inlet:**
A socket to connect the voice alarm router to the mains power (see section *Power*, page 68).
13. **Ground:**
A connection to electrically ground the router.
14. **Firmware upgrade connector:**
An RS232 connector to connect a PC to upgrade the firmware of the voice alarm router.
15. **Configuration settings:**
A set of DIP switches to configure the voice alarm router (see section *Voice alarm router*, page 82).
16. **System sockets:**
Two RJ45 sockets to connect other voice alarm routers to the voice alarm router (see section *Voice alarm routers*, page 51).
17. **Router ID:**
A rotary switch to set the ID of the router (see section *Voice alarm router*, page 82).
18. **External power amplifier (output):**
Two XLR sockets to connect external power amplifiers (see section *External power amplifier*, page 52). This socket is used in combination with the external power amplifier inputs (no. 6 and 24).
19. **Volume override:**
Three contacts (NC/24V/NO) to connect a fail-safe or a power-saving 4-wire volume override (see section *Volume overrides*, page 56).
20. **24 VDC output:** 800 mA.
21. **Power amplifier failure:**
Two pins (NC relays) to report a failure of the power amplifier.
22. **Trigger outputs:**
Two general purpose trigger outputs. For future use.
23. **Back-up power inlet:**
An inlet to connect a back-up power supply to the voice alarm router (see section *Power*, page 68).
24. **External power amplifier 2 (input):**
An input to connect an external power amplifier (see section *Voice Alarm Router*, page 109). These pins are used in combination with the external power amplifier output (no. 18).

3.4 Call Station

The Call Station can be connected to the Plena Voice Alarm System to make business calls. The maximum number of call stations in a Plena Voice Alarm System is 8.



Figure 3.5: Call Station

3.4.1 Buttons

Each call station has zone select buttons and a push-to-talk (PTT) button. The zone select buttons can be configured for selecting zones and zone groups in the system. To the PTT button, a pre and post chime can be assigned that is played at the start or at the end of the business call.

3.4.2 Supervision

The call station is not supervised. For compliance to evacuation standards, the Plena Voice Alarm System disables the call station during emergency calls.

3.4.3

Keypad

Each voice alarm router can add 6 extra loudspeaker zones to the system. To be able to distribute calls to the extra zones, it is possible to connect Remote Control Extension to the call station. The maximum number of keypads that can be connected to a call station is 8, with a maximum of 32 total in a system.



Notice!

To address zones in a 120-zone system, zone groups need to be made.



Figure 3.6: Call station keypad

3.4.4 Controls, connectors and indicators

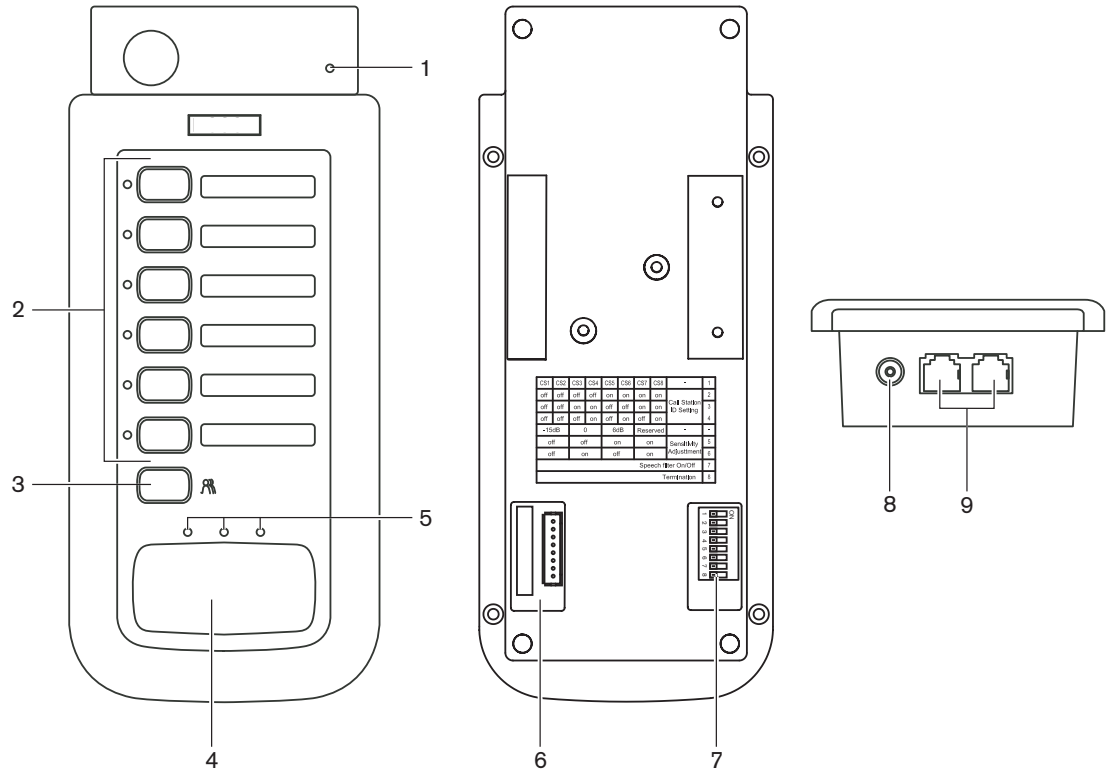

Figure 3.7: Top and bottom views of the call station

Controls, indicators and connectors on the call station:

1. **Power indicator:**
A green LED to indicate that the call station is powered on.
2. **Zone selection buttons:**
Six buttons to select the zones to which the business call is distributed (see section *Business calls*, page 89). Each button has a green LED, which indicates the zones to which the business call is distributed.
3. **'All call' button:**
A button to select all zones (see section *Business calls*, page 89).
4. **Push-to-talk button:**
A push-to-talk (PTT) button to start the business call.
5. **Status indicators:**
Three LEDs that indicate the status of the call station (see section *Make the announcement*, page 90).
6. **Keypad connector:**
A connector to connect call station keypads to the call station.
7. **Configuration settings:**
A set of DIP switches to configure the call station (see section *Call station*, page 83).
8. **Power supply inlet:**
A socket to connect a 24 V(DC) power supply (see section *Power supply*, page 69).
9. **System sockets:**
Two redundant RJ45 sockets to connect the call station to the voice alarm controller (see section *Call station*, page 50).

3.5 Call Station Keypad

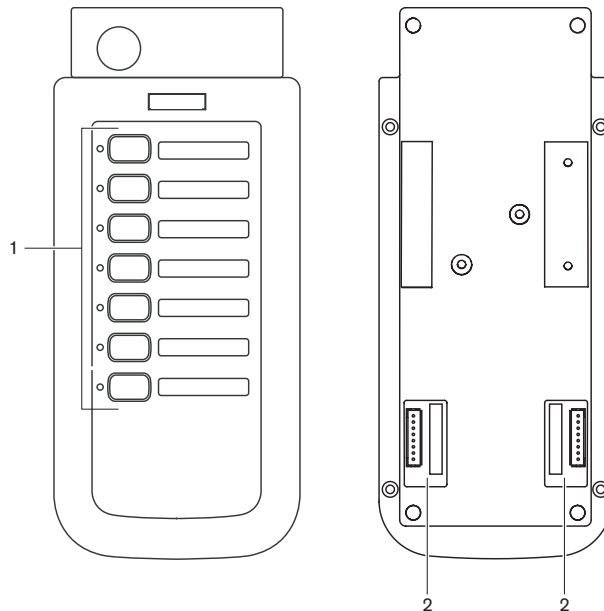

Figure 3.8: Top and bottom views of the call station keypad

Controls, indicators and connectors on the call station keypad:

1. **Zone selection buttons:**

Seven buttons to select the zones to which the business call is distributed (see section *Business calls*, page 89). Each button has a green LED, which indicates the zones to which the business call is distributed.

2. **Keypad connector:**

A connector to connect call station keypads to the call station or to other call station keypads (see section *Call Station Keypad*, page 44).

5. **Emergency call zone selectors:**

Six buttons to select the zones to which the emergency call must be distributed (see section *Emergency state, page 91*). Each button has a green and a red LED. The six red LEDs indicate the zones that are selected for the emergency call. The six green LEDs indicate the zones in which a business call is running.
6. **BGM zone selectors:**

Six buttons to select the zones to which the BGM is distributed (see section *Background music, page 88*). Each button has a green LED. The six green LEDs indicate the zones to which BGM is distributed. It is not possible to control the volume of the BGM with the remote control.
7. **All call button:**

A button to select all zones. This button is only available in the emergency state (see section *Emergency state, page 91*).
8. **Indicator test button:**

A button to test all LEDs on the front panel of the remote control and all connected remote control extensions. All LEDs are lit as long as the button is pushed (see section *Fault State, page 96*).
9. **Emergency button:**

A push button to put the system in the emergency state (see section *Emergency state, page 91*).
10. **Alert message button:**

A button to select the alert message. This button is only available in the emergency state (see section *Emergency state, page 91*).
11. **Alarm message button:**

A button to select the default alarm message. This button is only available in the emergency state (see section *Emergency state, page 91*).
12. **Microphone socket:**

A socket to connect the hand-held emergency microphone (see section *Emergency microphone, page 49*).
13. **Bracket:**

A bracket for the hand-held emergency microphone that is supplied with the remote control.
14. **Monitoring loudspeaker:**

Built-in monitoring loudspeaker.
15. **Ground:**

A connection to electrically ground the remote control.
16. **Firmware upgrade connector:**

An RS232 connector to connect a PC to upgrade the firmware of the remote control.
17. **Firmware upgrade switch:**

A switch to upgrade the firmware of the remote control.
18. **Remote control extension sockets:**

Two redundant RJ45 sockets to connect remote control extensions to the remote control (see section *Remote control extensions, page 70*).
19. **Configuration settings:**

A set of DIP switches to configure the remote control (see section *Remote control, page 85*).
20. **Controller socket:**

One RJ45 socket to connect the remote control to the voice alarm controller (see section *Voice alarm controller, page 70*).

21. **Emergency microphone volume control:**
A rotary knob to set the volume of the hand-held emergency microphone.
22. **Monitoring speaker volume control:**
A rotary knob to set the volume of the monitoring loudspeaker.
23. **Trigger outputs:**
Three general purpose trigger outputs. For future use.
24. **Status outputs:**
Three status outputs to send the status of the Plena Voice Alarm System to third party equipment (see section *Status output contacts, page 70*).
25. **24 V DC input:**
One 24 V(DC) input to connect the remote control panel to a power supply (see section *Power, page 71*).

3.7 Voice Alarm Remote Control kit

With the Voice Alarm Remote Control Kit, it is possible to make customized remote controls that can be connected to the voice alarm controller. The remote control kit provides the same functionality as the Voice Alarm Remote Control.

The rear panel of the remote control kit is the same as the rear panel of the Voice Alarm Remote Control (see *Voice Alarm Remote Control, page 25*).

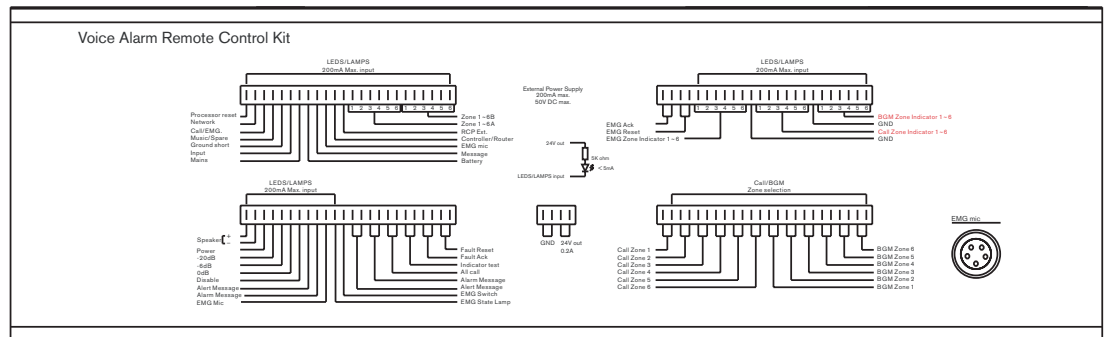

Figure 3.10: Front and rear views of the remote control kit

3.8 Remote Control Extension

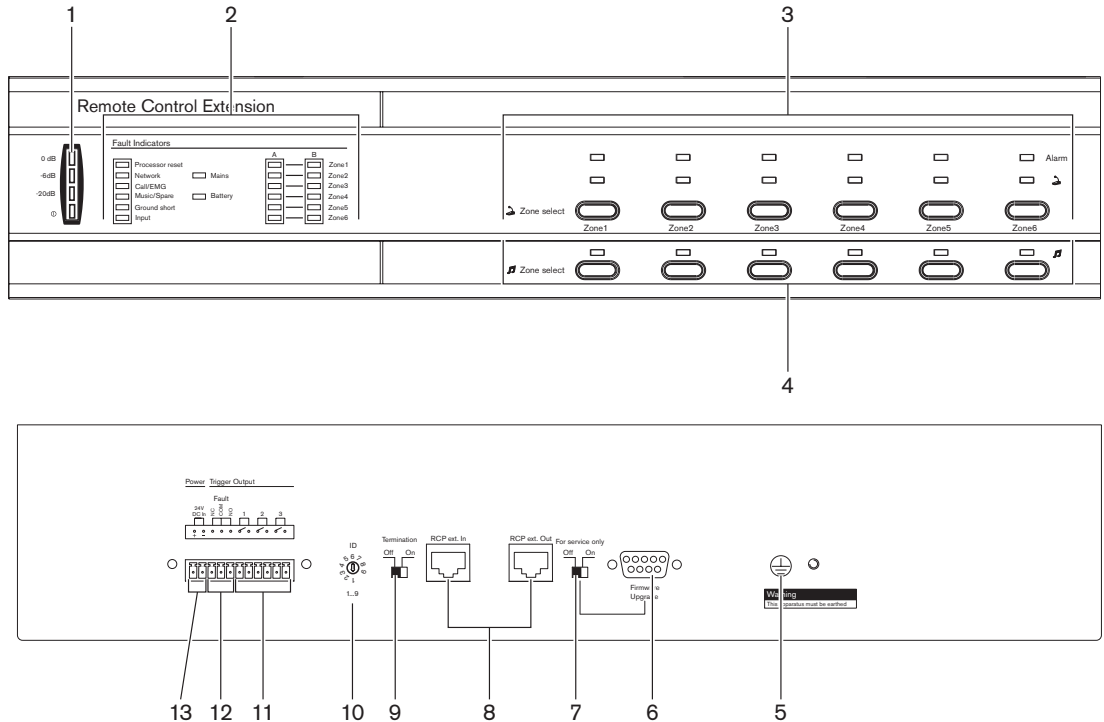

Figure 3.11: Front and rear views of the remote control extension

Overview of the controls, indicators and connectors on the remote control extension:

1. **Power LED/VU Meter:**
A combined power indicator and VU meter. The green power LED is lit if the remote control extension is connected to the mains or back-up power and switched on. The VU meter indicates the call level: 0 dB (red), -6 dB, -20 dB (yellow).
2. **Fault indicators:**
Eight yellow system fault LEDs (Processor reset, Network, Call/EMG, Music/Spare, Ground short, Input, Mains, Battery) and twelve yellow loudspeaker line fault LEDs. Fault indication is only possible if supervision is enabled (see section *Fault indicators*, page 98).
3. **Emergency call zone selectors:**
Six buttons to select the zones to which the emergency call must be distributed (see section *Emergency state*, page 91). Each button has a green and a red LED. The six red LEDs indicate the zones that are selected for the emergency call. The six green LEDs indicate the zones in which a business call is running.
4. **BGM zone selectors:**
Six buttons to select the zones to which the BGM is distributed (see section *Background music*, page 88). Each button has a green LED. The six green LEDs indicate the zones to which BGM is distributed.
5. **Ground:**
A connection to electrically ground the remote control extension.
6. **Firmware upgrade connector:**
An RS232 connector to connect a PC to upgrade the firmware of the remote control extension.

7. **Firmware upgrade switch:**
A switch to upgrade the firmware of the remote control extension.
8. **System sockets:**
One RJ45 socket to connect the remote control extension to the remote control (see section *Remote control extensions, page 70*).
9. **Configuration settings:**
A termination switch for the Remote Control Extension and 0-9 / 10-19 switch (see section *Remote control extension, page 86*).
10. **Remote control extension ID:**
A rotary switch to set the ID of the remote control extension (see section *Remote control extension, page 86*).
11. **Trigger outputs:**
Three general purpose trigger outputs. For future use.
12. **Status output:**
One status output to send the status of the Plena Voice Alarm System to third party equipment (see section *Status output contacts, page 73*).
13. **24 V DC input:**
One 24 V(DC) input to connect the remote control panel to a power supply (see section *Power, page 73*).

3.9

Remote Control Extension kit

With the Voice Alarm Control Extension Kit, it is possible to make customized remote control extensions that can be connected to a remote control (Fireman's Panel, Remote Control, Remote Control kit). The remote control extension kit provides the same functionality as the Voice Alarm Remote Control Extension.

The rear panel of the remote control extension kit is the same as the rear panel of the Voice Alarm Remote Control Extension (see *Remote Control Extension, page 28*).

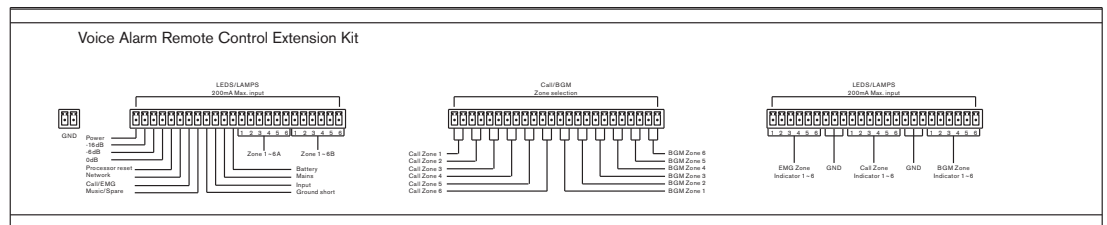

Figure 3.12: Front and rear views of the remote control extension kit

3.10 Fireman's Panel

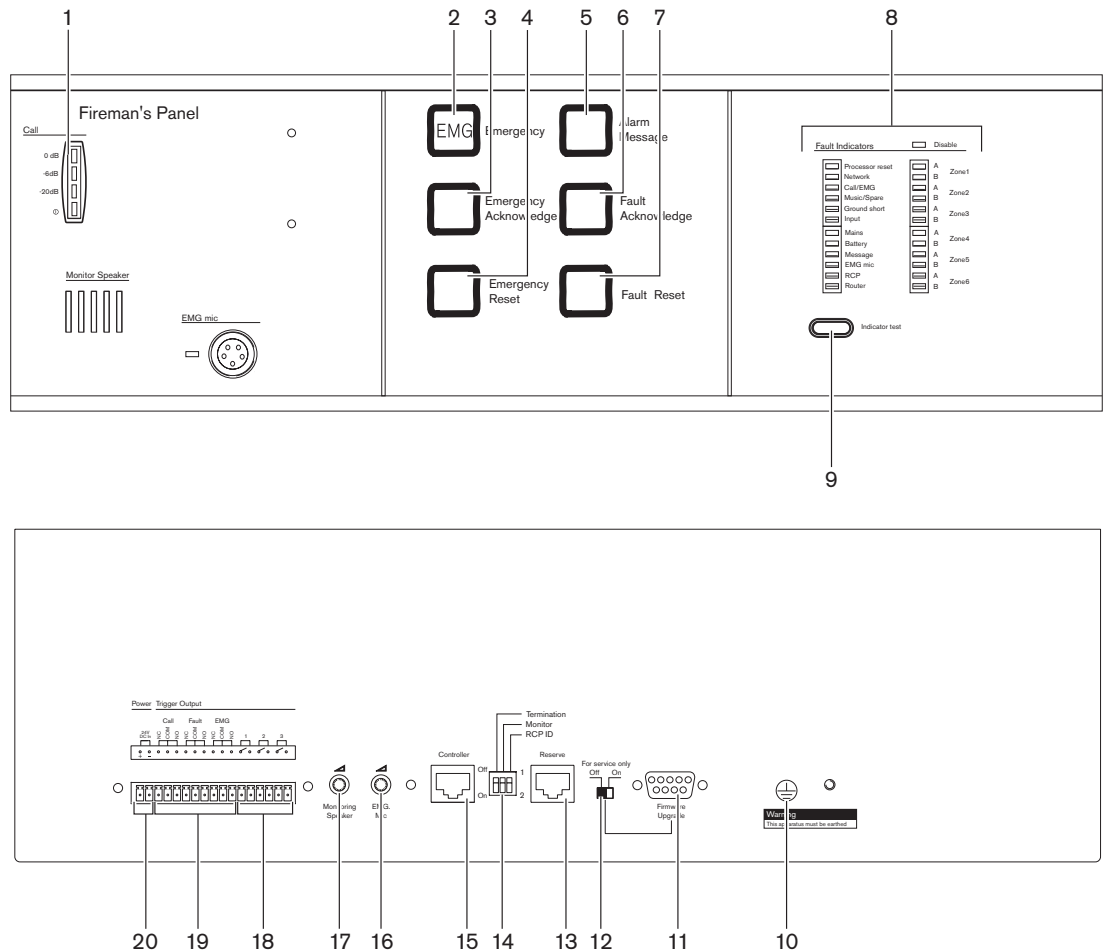

Figure 3.13: Front and rear views of the fireman's panel

Overview of the controls, connections and indicators on the fireman's panel:

1. **Power LED/VU Meter:**
A combined power indicator and VU meter. The green power LED is lit if the fireman's panel is connected to the power supply. The VU meter indicates the call level: 0 dB (red), -6 dB, -20 dB (yellow).
2. **Emergency button:**
A push button to put the system in the emergency state (see section *Emergency state*, page 91).
3. **Emergency acknowledge:**
A push button to acknowledge the emergency state (see section *Emergency state*, page 91).
4. **Emergency reset:**
A push button to reset the emergency state (see section *Emergency state*, page 91).
5. **Alarm message button:**
A push button to start the default alarm message. This button is only available in the emergency state (see section *Emergency state*, page 91).
6. **Fault acknowledge:**
A push button to acknowledge the fault state (see section *Fault State*, page 96).

7. **Fault reset:**
A push button to reset the fault state (see section *Fault State*, page 96).
8. **Fault indicators:**
Twelve yellow system fault LEDs (Processor reset, Network, Call/EMG, Music/Spare, Ground short, Input, Mains, Battery, Message, EMG mic, RCP and Router) and twelve yellow loudspeaker line fault LEDs. Fault indication is only possible if supervision is enabled (see section *Fault indicators*, page 98). If supervision is disabled, the yellow Disabled LED is lit.
9. **Indicator test button:**
A button to test all LEDs on the front panel of the fireman's panel and all connected remote control extensions. All LEDs are lit as long as the button is pushed (see section *Fault State*, page 96).
10. **Ground:**
A connection to electrically ground the fireman's panel.
11. **Firmware upgrade connector:**
An RS232 connector to connect a PC to upgrade the firmware of the fireman's panel.
12. **Firmware upgrade switch:**
A switch to upgrade the firmware of the fireman's panel.
13. **Remote control extension sockets:**
Two redundant RJ45 sockets to connect remote control extensions to the fireman's panel (see section *Remote control extensions*, page 70).
14. **Configuration settings:**
A set of DIP switches to configure the fireman's panel (see section *Remote control*, page 85).
15. **Controller socket:**
One RJ45 socket to connect the fireman's panel to the voice alarm controller (see section *Voice alarm controller*, page 70).
16. **Emergency microphone volume control:**
A rotary knob to set the volume of the hand-held emergency microphone.
17. **Monitoring speaker volume control:**
A rotary knob to set the volume of the monitoring loudspeaker.
18. **Trigger outputs:**
Three general purpose trigger outputs. For future use.
19. **Status outputs:**
Three status outputs to send the status of the Plena Voice Alarm System to third party equipment (see section *Status output contacts*, page 74).
20. **24 V DC input:**
One 24 V(DC) input to connect the fireman's panel to a power supply (see section *Power*, page 74).

3.11 End Of Line detection board

The End Of Line (EOL) detection board makes a continuous check of the integrity of the loudspeaker line based on a pilot tone. This check is in addition to the check given by the impedance measurement. The pilot tone is independent of the quantity of the loudspeakers in the system or the load on the speaker cables.

The EOL is installed in the speaker cabinet at the furthest point on a loudspeaker line. When the EOL detects a pilot tone that is given by the voice alarm system, the loudspeaker lines have no fault. The EOL trigger output is closed and the LED lights up to show that the lines have a pilot tone signal.

If the loudspeaker cable has a fault, the pilot tone stops. The EOL circuit becomes open, which is detected by the Voice Alarm Controller.

One EOL board can be installed to give a single fault indication per zone or more than one can be installed on a single fault input to check the integrity of a loudspeaker line with several branches. When more than one EOL board is installed, the configuration is called a daisy-chain.

When a fault is detected by the Voice Alarm Controller, to find the EOL board that detects the failure, every individual board must be checked.

3.12 Application examples

3.12.1 Schools

Schools are typical example of applications with a large number of zones each with a relatively low output power requirement per zone. The main priorities are speech intelligibility and compliance with IEC 60849 standard (or equivalent). In addition to mandatory voice alarm functionality for evacuating staff and students, EVAC systems for schools should also include chime tones for notifying the start/finish of lessons, plus public address functionality for individually calling classrooms or public area. BGM is not essential. Since a classroom has a low ambient noise level, 1 loudspeaker is usually sufficient, keeping the total power requirement relatively low. Outside areas such as playgrounds and sports fields will require weatherproof horn loudspeakers.

Summary of requirements

- Typically 20 to 60 zones (in high schools)
- Speech intelligibility is the main priority
- Low power requirement (1 loudspeaker) per classroom
- Fireman's panel by main entrance
- Call station in main office
- Additional public address functions such as chime tones desirable
- BGM in recreation areas is optional

Solution for a 30-zone system

The Plena Voice Alarm System Controller handles message routing to 6 zones, the remaining 24 zones require four additional 6-zone routers. The office is equipped with a call station plus keypads for individually addressing zones, while a fireman's panel (with overall priority) is built in by the main entrance.

Power requirements

The system controller features a built-in 240 W power amplifier, making it possible to drive up to 40 loudspeakers with a power handling capacity of 6 W each. This is sufficient for a medium-sized high school with 24 classrooms, 4 toilets/changing rooms, a staff meeting room

and 2 offices, each requiring a single loudspeaker. The canteen, assembly hall, playing fields and corridors typically require more loudspeakers per zone. An additional Plena Power Amplifier is used as a spare amplifier.

Layout

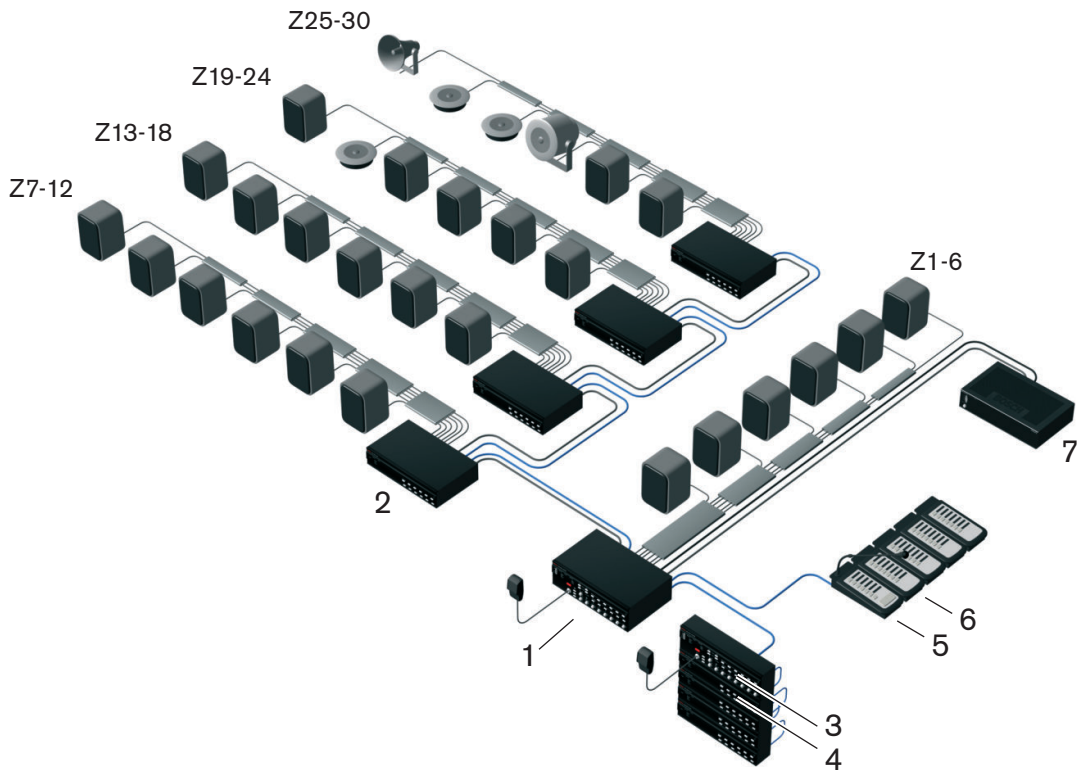

Figure 3.14: Example of a school

Number	Unit	Description	No.
1	LBB 1990/00	Controller	1 x
2	LBB 1992/00	Router	4 x
3	LBB 1996/00	Remote control	1 x
4	LBB 1997/00	Remote control extension	4 x
5	LBB 1956/00	Call station	1 x
6	LBB 1957/000	Call station keypad	4 x
7	LBB 1935/20	Power Amplifier (240 W)	1 x

Table 3.1: Units

Zone	Description	Power
Z1-22	Classrooms	22 x 6 W
Z23	Toilets/changing rooms	4 x 6 W
Z24	Staff meeting room	1 x 6 W

Zone	Description	Power
Z25-26	Offices	2 x 6 W
Z27	Corridors	4 x 6 W
Z28	Assembly hall	2 x 6 W
Z29	Lunch canteen	2 x 6 W
Z30	Playing fields	1 x 10 W
	Total	232 W

Table 3.2: Zones

3.12.2

Swimming pool

Swimming pools and other indoor sports and recreational facilities are typical examples of smaller applications with few zones. The main priorities are excellent speech intelligibility and compliance with IEC 60849 standard (and its national equivalents), although music in different areas is optional. An EVAC system for a swimming pool requires voice alarm functionality with public address functionality for regular announcements and background music (optional). To ensure that all visitors in the relatively noisy pool area hear emergency messages, the power output for that zone is relatively high. Other areas, such as the changing rooms and offices, have lower power requirements.

Summary of requirements

- Typically up to 6 zones
- Speech intelligibility is the main priority
- High power requirement in the noisy pool area
- Fireman's panel by fire exit
- Call station in office/reception
- Additional public address functions for announcements
- BGM

Solution for a 5-zone system

The Plena Voice Alarm System controller handles routing to up to 6 zones, so no additional routers are required. The office/reception is equipped with a call station plus keypad for individually addressing zones, while a fireman's panel (with overall priority) is built-in by the emergency exit. The Plena Voice Alarm System is a two-channel system, so BGM can still be provided in zones not receiving a call.

Power requirements

The system controller has a built-in 240 W power amplifier, making it possible to drive up to 40 loudspeakers with a power handling capacity of 6 W each. The pool area requires high power music loudspeakers qualified for use in a high humidity atmosphere. The snack bar uses cabinet loudspeakers for music reproduction. The zones are defined as indicated in the table. An additional Plena Power Amplifier is used for two-channel operation and as a spare amplifier.

Layout

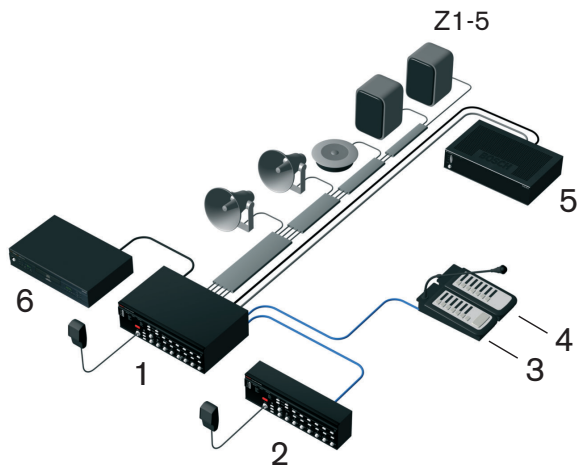

Figure 3.15: Example of a swimming pool

Number	Unit	Description	No.
1	LBB 1990/00	Controller	1 x
2	LBB 1996/00	Remote control	1 x
3	LBB 1956/00	Call station	1 x
4	LBB 1957/00	Call station keypad	4 x
5	LBB 1935/20	Power Amplifier (240 W)	1 x
6	Bosch	Music source	1 x

Table 3.3: Units

Zone	Description	Power
Z1	Indoor pool area	5 x 30 W
Z2	Children’s pool area	2 x 10 W
Z3	Changing rooms	4 x 6 W
Z4	Snack-bar	4 x 6 W
Z5	Office	2 x 6 W
	Total	230 W

Table 3.4: Zones

3.12.3

Shopping mall

Shopping malls are typical example of applications with a large number of zones with varying output power requirements per zone. The priorities are speech intelligibility and compliance with IEC 60849 standard (and its national equivalents). In addition to mandatory voice alarm functionality for evacuating the public and shop personnel, an EVAC system for shopping centers can have BGM for the public areas. It should be possible to individually call each shop or store. During emergency messages, each shop's BGM volume control is automatically overridden. Additional public address functionality for making general public announcements is an optional requirement.

Summary of requirements

- Typically up to 60 zones
- Speech intelligibility is the main priority
- Variable power requirement per zone
- Call station in security control room
- Additional public address functionality (non-emergency)
- BGM in public areas
- BGM music with local override in shops

Solution for a 54-zone system

A Plena Voice Alarm System Controller handles routing to 6 zones, the remaining 48 zones require eight 6-zone routers. The security control room is equipped with a remote control panel and call station plus keypads for individually addressing zones and BGM for the public areas, while the controller unit and routers are located in a fire-resistant cabinet or basement. Fireman's panel (with overall priority) is built-in close to the main entrance or emergency exit (subject to relevant local regulations). The Plena Voice Alarm System is a two-channel system, so BGM can still be provided in zones not receiving a call.

Power requirements

Each zone will have varying power requirements, ranging from small shops with a single loudspeaker to department stores with several floors and more loudspeakers. Parking garages and open-air walkways will require weatherproof sound projectors or horn loudspeakers. To facilitate phased evacuation from different levels of the shopping center, public areas are divided into zones. Additional Plena Power Amplifiers are incorporated to provide additional power, two-channel operation and for use as a spare amplifier.

Layout

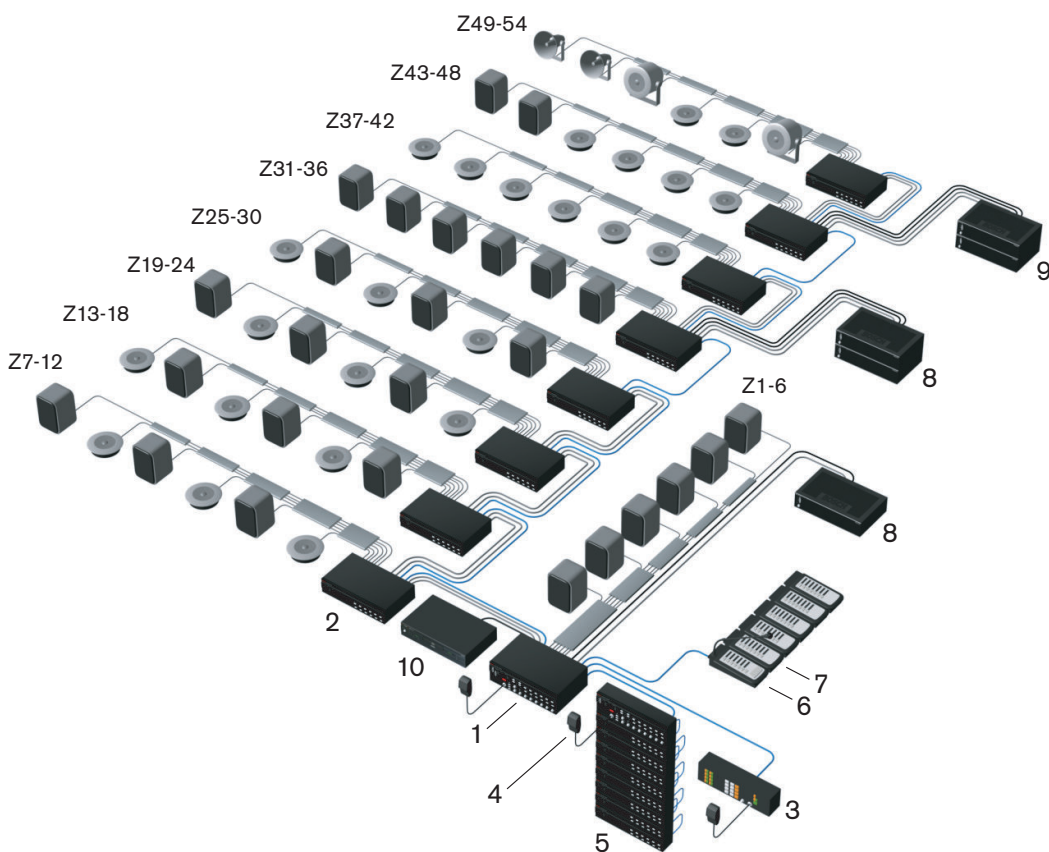

Figure 3.16: Example of a shopping mall

Number	Unit	Description	No.
1	LBB 1990/00	Controller	1 x
2	LBB 1992/00	Router	8 x
3	LBB 1995/00	Fireman's Panel	
4	LBB 1996/00	Remote control	1 x
5	LBB 1997/00	Remote control extension	8 x
6	LBB 1956/00	Call station	1 x
7	LBB 1957/00	Call station keypad	5 x
8	LBB 1935/20	Power Amplifier (240 W)	3 x
9	LBB 1938/20	Power Amplifier (480 W)	2 x
10	Bosch	Music source	1 x

Table 3.5: Units

Zone	Description	Power
Z1-30	30 small shops/kiosks	30 x 6 W
Z31-36	6 shops	12 x 6 W

Zone	Description	Power
Z37-42	6 medium-sized stores	24 x 6
Z47	Security control room	1 x 6 W
Z48	Offices	4 x 6 W
Z49	Walkways ground floor	4 x 6 W
Z50	Gallery 1st floor	10 x 6 W
Z51	Gallery 2nd floor	10 x 6 W
Z52	Main public square	4 x 18 W
Z53	Parking garage level 1	6 x 10 W
Z54	Parking garage level 2	6 x 10 W
	Total	858 W

Table 3.6: Zones

3.12.4

Hotel

Smaller hotels are typical examples of applications with relatively few zones, each with a medium to high output power requirement. The priorities are speech intelligibility and compliance with IEC 60849 standard. In addition to mandatory voice alarm functionality for evacuating guests and staff, an EVAC system for a hotel should also include BGM in the restaurant, bar and lobby, plus public address functionality for general paging. To ensure that all guests hear an emergency message, the power output per zone is relatively high. Outside areas such as car parking garages, require weatherproof horn loudspeakers.

Summary of requirements

- Typically 10 to 20 zones in small hotels
- Speech intelligibility is the main priority
- High power requirement (multiple loudspeakers) per floor
- Fireman's panel by fire exit
- Call stations in reception and office
- Additional public address functions for paging guests
- BGM in lobby and restaurant

Solution for a 12-zone system

A Plena Voice Alarm System Controller handles routing to up to 6 zones, the additional 6 zones require a router. Both the reception and office are equipped with call stations plus keypads for individually addressing zones, while a fireman's panel (with overall priority) is built-in by the emergency exit. The Plena Voice Alarm System is a two-channel system, so BGM can still be provided in zones not receiving a call.

Power requirements

The system controller features a built-in 240 W power amplifier, able to drive up to 40 loudspeakers (6 W). Additional Plena Power Amplifiers are incorporated to provide additional power, two-channel operation and spare amplification. To facilitate phased evacuation from different floors of the hotel, guest areas are divided into separate zones, each fitted with 13 ceiling loudspeakers in the corridors. The bar uses cabinet loudspeakers, while the parking garage uses weatherproof horn loudspeakers.

Layout

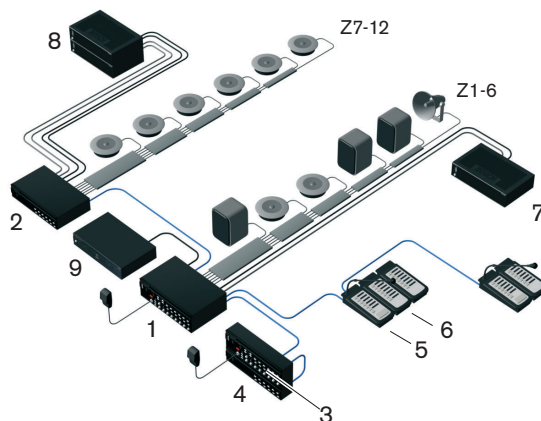

Figure 3.17: Example of a hotel

Number	Unit	Description	No.
1	LBB 1990/00	Controller	1 x
2	LBB 1992/00	Router	1 x
3	LBB 1996/00	Remote control	1 x
4	LBB 1997/00	Remote control extension	1 x
5	LBB 1956/00	Call station	2 x
6	LBB 1957/00	Call station keypad	3 x
7	LBB 1935/20	Power Amplifier (240 W)	1 x
8	LBB 1938/20	Power Amplifier (480 W)	2 x
9	Bosch	Music source	1 x

Table 3.7: Units

Zone	Description	Power
Z1	Bar	3 x 6 W
Z2	Restaurant	6 x 6 W
Z3	Lobby	2 x 6 W
Z4	Office	1 x 6 W
Z5	Kitchens	2 x 6 W
Z6	Parking garage	3 x 10 W
Z7-12	Floors 1 to 6	78 x 6 W
	Total	582 W

Table 3.8: Zones

3.13 Calls and priorities

As the Plena Voice Alarm System is a public address and emergency sound system, it is used to distribute background music, business calls and emergency calls.

3.13.1 Priority

To each call, a priority is assigned. When two or more calls are addressed to the same zone or need shared resources (e.g. the internal message manager of the voice alarm controller), the call with the lower priority is stopped immediately and the call with the higher priority is started. The priority of a call depends on the part of the system that started the call and must be configured with the configuration software.



Notice!

See the Configuration Software Manual for more information about the configuration software.

When two or more calls with the same priority are addressed to the same zone or need shared resources (e.g. the internal message manager of the voice alarm controller), the oldest call is stopped immediately and the youngest call is started. An exception to this rule are mergeable messages (see section *Mergeable messages*, page 42).

3.13.2 Mergeable messages

When two or more calls are started that are based on the same mergeable message template and have the same priority, the calls are merged. The youngest call will not stop the oldest call in this case. Mergeable message can be created with the configuration software.

3.13.3 Business call

A business call is a call that is made when the system is in the normal state. Business calls always have a priority between 2 and 8 and can be started with:

- Business trigger inputs
- Call stations
- The mic/line input with VOX functionality of the voice alarm controller

3.13.4 Emergency call

An emergency call is a call that is made when the system is in the emergency state. Emergency calls have a certain priority in the configuration software, and can be started with:

- Emergency trigger inputs (priority between 2 and 14)
- The hand-held emergency microphone of the voice alarm controller (priority between 9 and 19)
- The mic/line input with VOX functionality of the voice alarm controller (priority between 2 and 14)

4 Installation

4.1 Voice Alarm Controller

The voice alarm controller is suitable for table-top and 19-inch rack-mounting installation. Two brackets for rack-mounting are supplied.

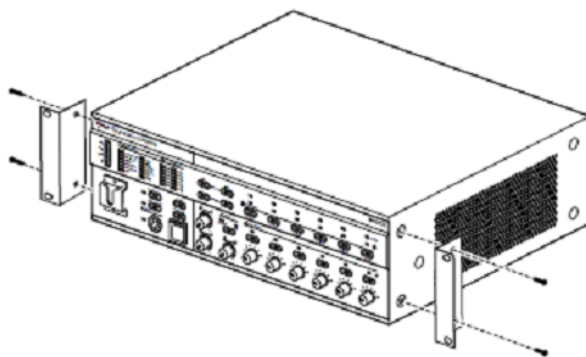

Figure 4.1: Brackets for rack-mounting

Make sure that there is a free space of at least 100 mm on both sides of the unit for ventilation. The voice alarm controller has an internal fan, which is regulated to keep the temperature inside the unit within the safe operating area.

4.2 Voice Alarm Router

The voice alarm router is suitable for table-top and 19-inch rack mounting installation. Two brackets for rack-mounting are supplied. Installing a voice alarm router is similar to installing a voice alarm controller (see section *Voice Alarm Controller*, page 43).

4.3 Call Station Keypad

Call station keypads can be connected to call stations or to other call station keypads.

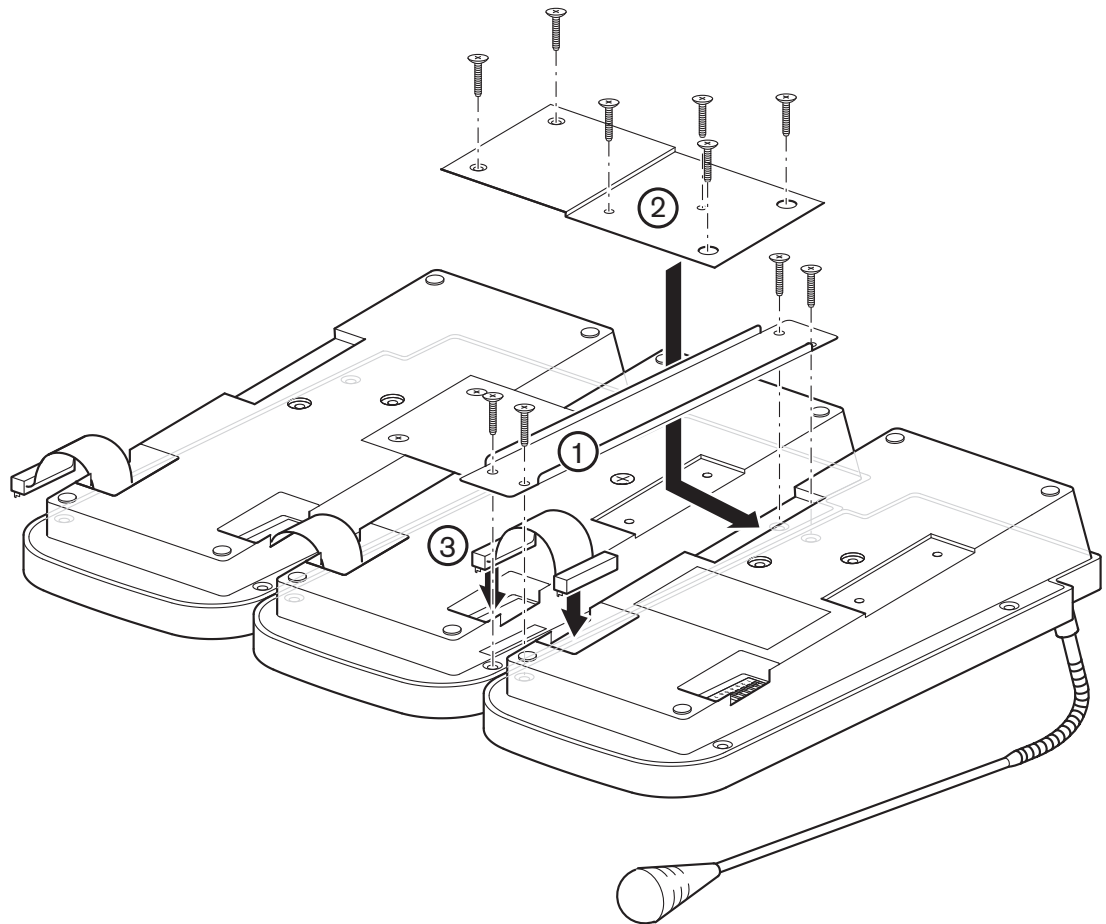

Figure 4.2: Connecting call station keypads

4.4 Voice Alarm Remote Control

The remote control is suitable for table-top and 19-inch rack mounting installation. Two brackets for rack-mounting are supplied. Installing a remote control is similar to installing a voice alarm controller (see section *Voice Alarm Controller*, page 43). The brackets can also be used to attach the remote control to a wall.

4.5 Voice Alarm Remote Control Kit

The remote control kit is suitable for table-top and 19-inch rack mounting installation. Two brackets for rack-mounting are supplied. Installing a remote control kit is similar to installing a voice alarm controller (see section *Voice Alarm Controller*, page 43).

4.6 Remote Control Extension

The remote control extension is suitable for table-top and 19-inch rack mounting installation. Two brackets for rack-mounting are supplied. Installing a remote control extension is similar to installing a voice alarm controller (see section *Voice Alarm Controller, page 43*). The brackets can also be used to attach the remote control extension to a wall.

4.7 Remote Control Extension Kit

The remote control extension kit is suitable for table-top and 19-inch rack mounting installation. Two brackets for rack-mounting are supplied. Installing a remote control kit is similar to installing a voice alarm controller (see section *Voice Alarm Controller, page 43*).

4.8 End Of Line detection board

To install an EOL, use these general notes:

- An EOL board can only be installed in a 2-channel system. The EOL board needs the second amplifier to produce the pilot tone for the zones that are not in use. Refer to section *2-Channel mode operation, page 78*.
- The volume control on the VAC must be set to -9 dB or higher. The recommended setting is 0 dB. A lower dB setting attenuates the pilot-tone.



Notice!

You must use either EOL or impedance measurement, not both.



Notice!

Do not connect the EOL board to the secondary side of a volume control. The secondary side of a volume control can attenuate the pilot tone.

All inputs to a VAC or router that have an EOL input must be normally closed inputs. The EOL board operates with a normally closed output and the configuration software is set to Action Open. Use another router to receive normally open inputs.



Notice!

During a call the pilot tone is absent in zones without a call or without background music. The LED on the EOL board is dim. The EOL input is ignored during calls to avoid false fault readings.

The short circuit check must be set in the configuration software.



Notice!

The EOL board detects a short circuit, but the EOL cannot detect where the short circuit is.



Notice!

It is possible for the LED to turn off before the contact is opened or vice versa. This level difference is typically less than 500 mV.

4.8.1 Installation of a single EOL

1. Connect the two cables at the end of the 100 V loudspeaker line to the Input 100 V LS on the EOL board.
2. Connect the two cables from an Emergency Trigger Input on the Voice Alarm Controller to TRGA on the EOL.
3. Connect the jumpers JP1 on the EOL as shown.

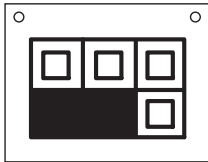

Figure 4.3: JP1 for single EOL

4.8.2 Installation of a multiple EOL in a daisy-chain

With a daisy-chain configuration it is possible to:

- Supervise several loudspeaker lines with only one fault input.
- Supervise several branches of a loudspeaker line with just one fault input.

1. Connect the cable from the 100 V loudspeaker line to the terminal 100 V LS Input on the EOL board.
2. Connect one cable from an Emergency Trigger Input on the Voice Alarm Controller to the FIRST BOARD input on the EOL board.

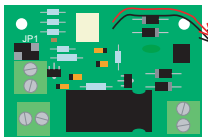

Figure 4.4: JP1 for first EOL

3. Connect a 20 or 22 kOhm resistor in parallel with the Trigger input to connect more than one EOL board on a single Trigger input and to supervise them.
4. Connect the EOL boards to the Trigger input as indicated previousl. This input should be on the Controller or Router to which the loudspeaker lines it supervises are also connected



Notice!

The last EOL board in line is connected in a different way than the other EOL boards. This is required to supervise the whole EOL detection line against short circuit. Such a short circuit will be reported as an Input Fault. A break in the detection line will be reported as a Line Fault, just as a loudspeaker line failure.

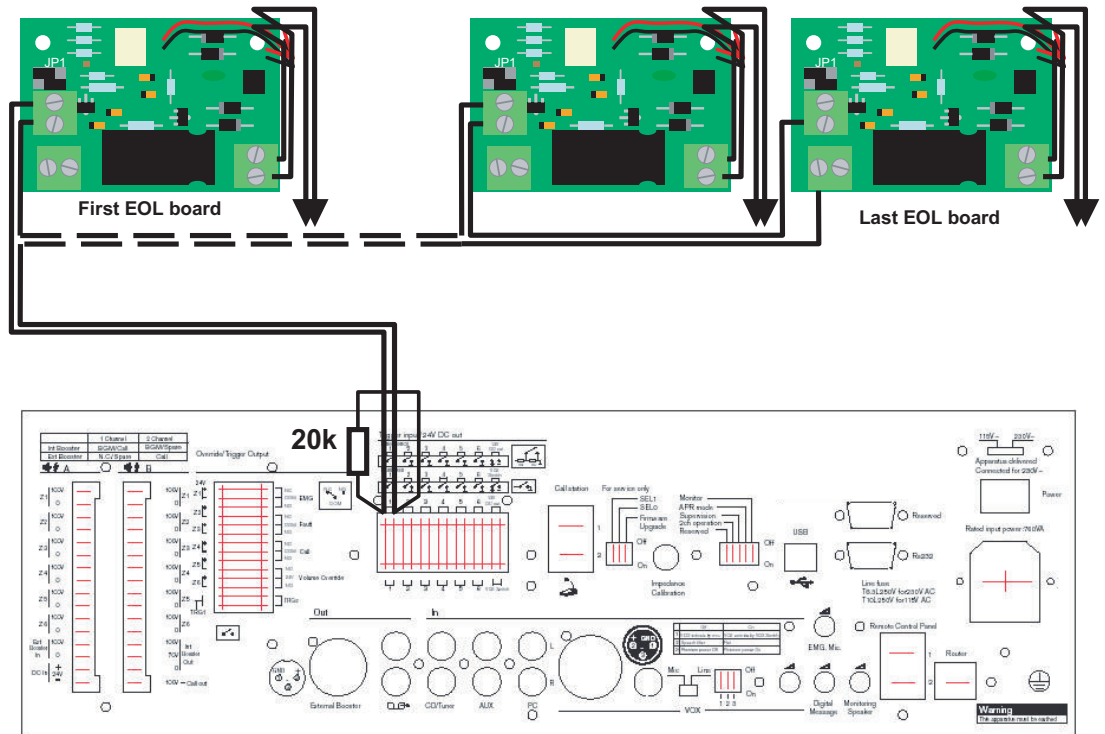

Figure 4.5: Trigger input indication

5. In the configuration program, set the Action Programming for the relevant input to Fault and EOL.
6. Enter the Zone or Zone group that is monitored by the EOL board. The Zone group can be All Zones (of the Controller/Router), Zone 1-3 or Zone 4-6. Fault Type and Zone will define the visual indication on the unit in case of a fault.
7. Set the Action to Open and Type to Momentary.

4.9 Dummy load

To install the Dummy load do as follows:

1. Connect the two leads onto the connection terminals of the last loudspeaker in a line.
2. Attach the Dummy Load circuit board in the loudspeaker cabinet to the mounting studs.



Notice!

In some loudspeakers only one mounting stud is available as the studs are too far apart.

4.9.1

Set the jumper JP1 on the Dummy load

The Dummy load incorporates the following functions:

- Increases the percentage of impedance (with respect to the cable impedance) present at the end of the line.
- Allows more loudspeakers to be fitted.
- Allows longer cable lengths.

Fault detection of the loudspeaker lines with impedance measurement is triggered by a change in excess of 20%. The impedance at the end of the loudspeaker line must be more than 20% of the total impedance to make sure that an open circuit is detected.

The Dummy Load has a jumper to set the load at 20 kHz to 8, 20 and 60 W.



Notice!

You can download the Dummy load calculator.xls from the Plena Voice Alarm System product related information on www.boschsecurity.com.

1. Use the Dummy load calculator to calculate the jumper setting of JP1 on the Dummy load.
2. Select the Excel sheet Dummy load calculator. Click Enable Macros when the dialog box appears. The worksheet opens.
3. Type the load per loudspeaker in Step 1. The maximum number of loudspeakers is automatically calculated and appears in Step 2.
4. Type the number of loudspeakers in the line in Step 2. The result automatically appears in Step 3.
5. Type the capacitance of the 100 V cable in Step 4.
6. Type the length of the cable in Step 5.
7. Click Display jumper JP1 settings. The configuration of the jumper settings appears.
8. Set the jumper JP1 on the Dummy load to the shown in the calculator.

5 Connection

5.1 Voice Alarm Controller

5.1.1 Emergency microphone

The voice alarm controller has 1 connector for an emergency microphone. A hand-held emergency microphone is supplied with the voice alarm controller. See for installation details below. Turn the lock ring clockwise to lock the plug.

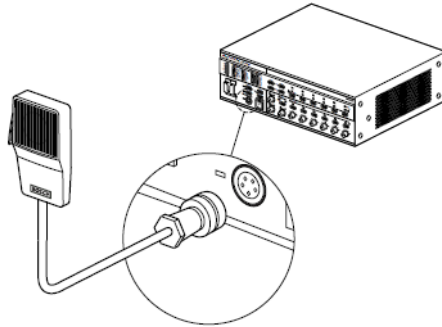

Figure 5.1: Connecting the emergency microphone

5.1.2

Call station

The voice alarm controller has 2 sockets for Call Stations. Use CAT-5 Ethernet cables with RJ45 plugs to connect call stations to the voice alarm controller. When the system requires more than 2 call stations, use the system sockets on the call stations to make loop-throughs. See the connection details below.

The controller comes with CAN bus termination installed. This is an RJ45 connector with built-in termination. Make sure that it is installed in the unused connector. On the routers and call station the termination switch setting must be in the "ON" position on the last device.

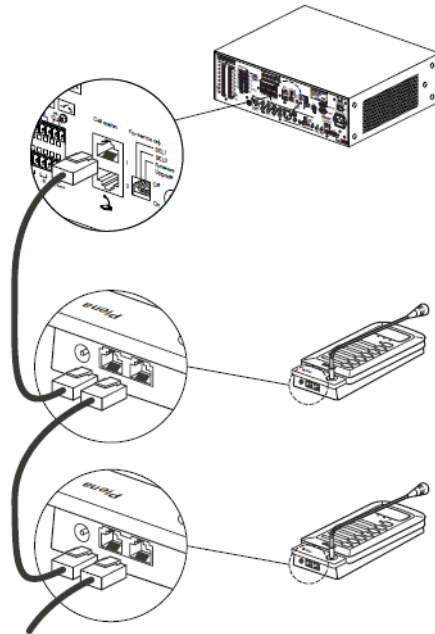

Figure 5.2: Connecting call stations



Notice!

Each connected call station must have a unique ID (see section *Call station*, page 83).

If the cable between the call station and the voice alarm controller is too long to power the call station, it is possible to connect a 24 VDC power source (see section *Power supply*, page 69).

5.1.3

Voice alarm routers

The voice alarm controller has 1 socket for Voice Alarm Routers. Use shielded CAT-5 Ethernet cables with RJ45 plugs to connect a voice alarm router to the voice alarm controller. When the system requires more than 1 voice alarm router, use the system sockets on the voice alarm router to make loop-throughs. See the connection details below.

The router come with CAN bus termination installed. This is an RJ45 connector with built-in termination. Make sure that it is installed in the unused connector. On the routers and call station the termination switch setting must be in the "ON" position on the last device.

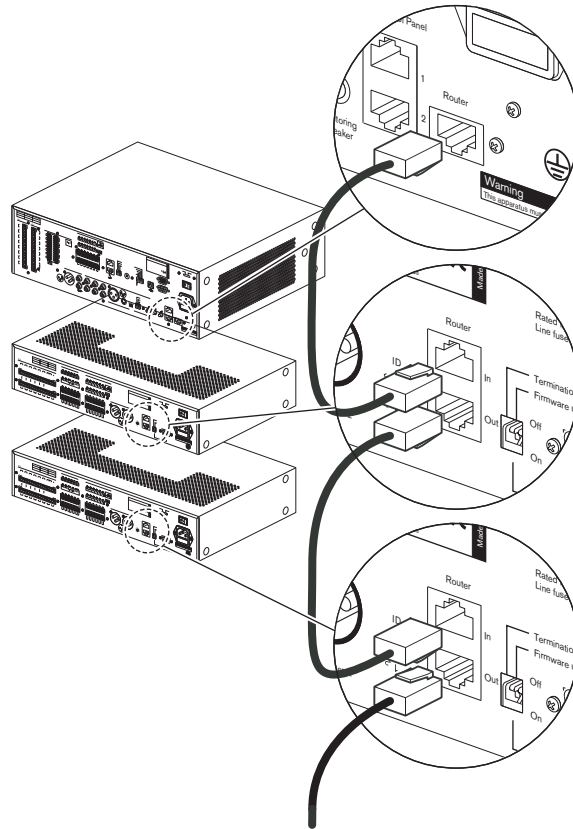

Figure 5.3: Connecting routers



Notice!

Each connected voice alarm router must have a unique ID (see section *Voice alarm router*, page 82).



Notice!

The voice alarm controller comes delivered with termination plugs (connectors) fitted in some RJ45 sockets. When connecting routers and RCP panels, the connected device must have their termination set to on, and the termination plug has to be plugged in the unused socket.

5.1.4

External power amplifier

The voice alarm controller has 1 external power amplifier output (line level, 1 V) and 1 external power amplifier input (100 V) to connect an external power amplifier. The function of the external power amplifier (e.g. a Plena Power Amplifier 360/240W) depends on the channel mode for which the voice alarm controller is configured (see section *1-Channel mode operation*, page 77 and section *2-Channel mode operation*, page 78).

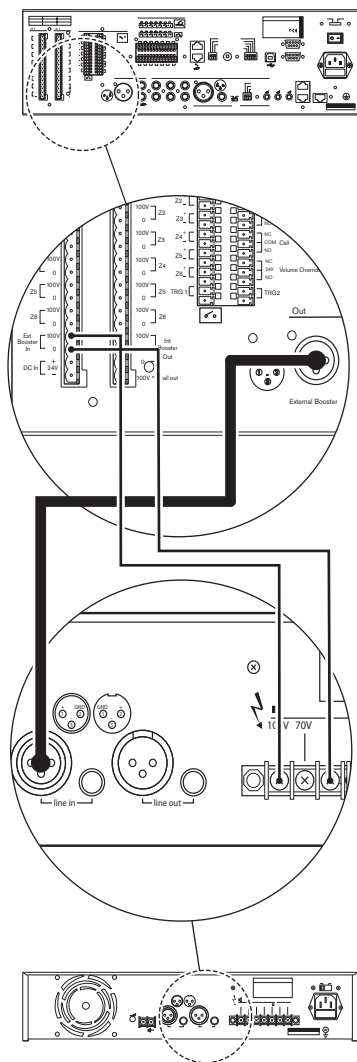

Figure 5.4: Connecting an external power amplifier

5.1.5

Remote controls

The voice alarm controller has 2 sockets for remote controls. Use shielded CAT-5 Ethernet cables with RJ45 plugs to connect a remote control to the voice alarm controller. See the connection details below:

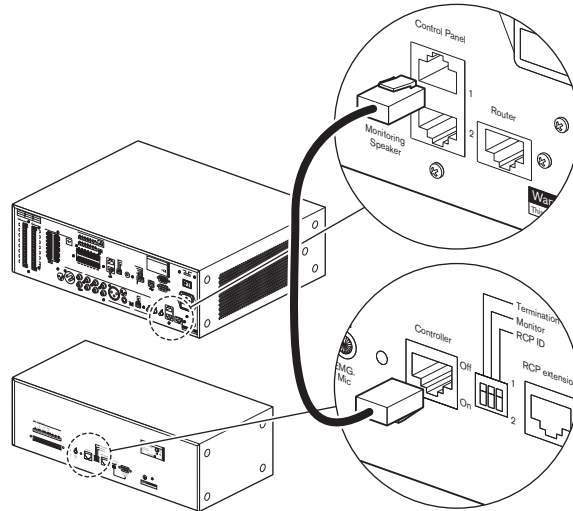

Figure 5.5: Connecting a remote control

5.1.6

Loudspeakers

The voice alarm controller has 6 zone outputs (Z1 to Z6). Each zone output consists of 2 redundant loudspeaker lines (line A and line B). Normally, calls and BGM are distributed to a zone over both loudspeaker lines. If one of the loudspeaker lines of a zone fails, it is still possible to distribute calls and BGM to the zone over the remaining loudspeaker line.

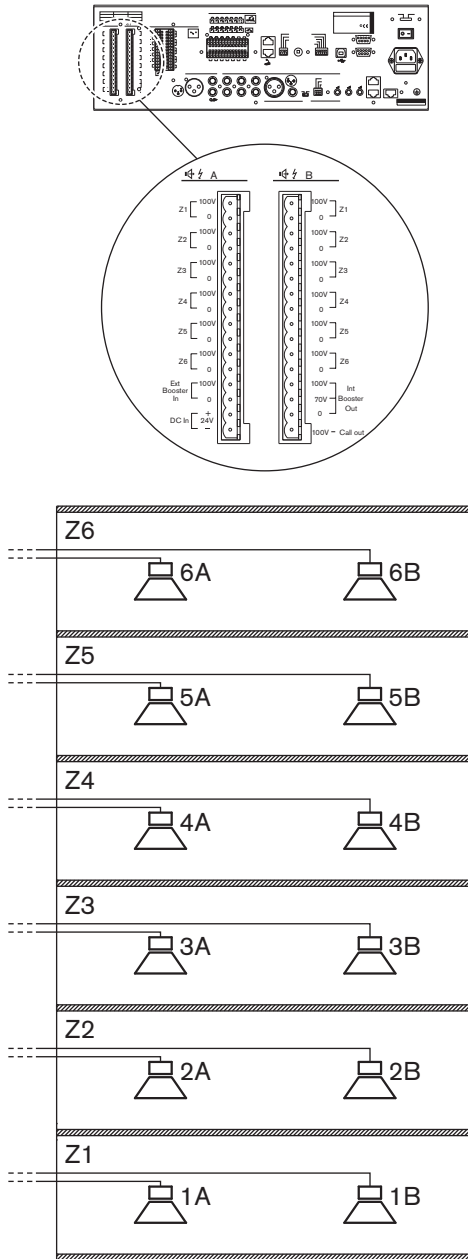

Figure 5.6: Connecting loudspeaker zones

If it is necessary to detect the removal or failure of a single loudspeaker, the following is advised:

- Do not connect more than 5 loudspeakers to the same loudspeaker line (line A or line B). Field tests have shown that the impedance of loudspeakers and loudspeaker lines varies with temperature and age. The limit of 5 loudspeakers is set due to this variation. In a more stable environment, the number of loudspeakers can be higher.
- Make sure that all loudspeakers connected to the same loudspeaker line have the same impedance.

**Notice!**

The impedance measurement of the Plena Voice Alarm System has an accuracy better than 2%. The system only generates a fault if the line impedance difference is greater than the configured accuracy. Use the configuration software to configure the accuracy

**Notice!**

See the Configuration Software Manual for more information about the configuration software.

**Notice!**

The maximum load for the internal power amplifier of the voice alarm controller is 240 W. However, if the voice alarm controller is used in 2-channel mode and an external 480 W amplifier is connected to it, the maximum loudspeaker load can be 480 W at 100 V. This is because in 2-channel mode, the internal power amplifier of the voice alarm controller is used for BGM only and distributes BGM at -3 dB, from which follows that the maximum power output is 240 W at 70 V and that the loading caused by 100 V loudspeakers at 70 V is also 240 W. The external amplifier is used for calls only with 480 W output power and 100 V loudspeaker line voltage.

**Notice!**

The voice alarm system has great flexibility, from one amplifier for all routers to one amplifier per router, or any arrangement in between. But in a 2-channel system, the number and type of amplifiers for the call-channel has to be exactly mirrored for the music channel. Getting the signal from the same routers and feeding loudspeaker signal to the same set of routers. If not, amplifier supervision and amplifier sparing will not function properly.

5.1.7 Volume overrides

The voice alarm controller has 6 override outputs; 1 for each zone in the system. These are suitable for 4-wire override (24 V) and 3-wire override.



Notice!

By default, the voice alarm controller is configured for 4-wire (24 V), power-saving override (refer to situation I below).

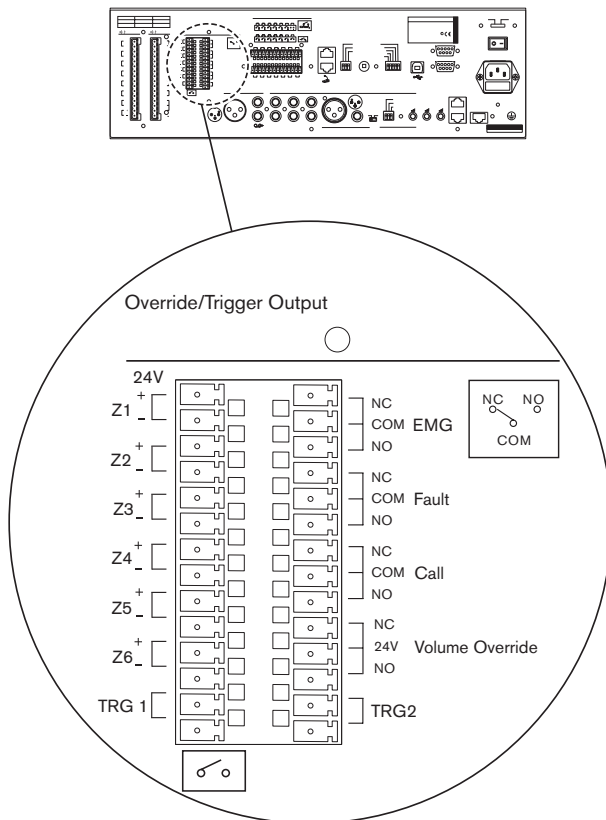

Figure 5.7: Override outputs

Internally, the positive override pins (Z+) are all connected to either the NC or the NO contact of the Volume Override output. The negative override pins (Z-) are all connected to earth.

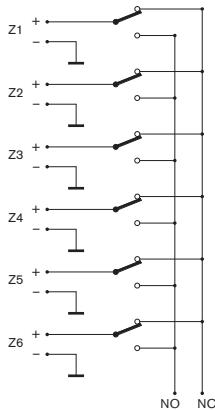

Figure 5.8: Volume override contacts

Normally, when there are no active calls, the Z+ pins are internally connected to the NC contact of the Volume Override. At the moment a call is started in a zone, the Z+ pin of the zone is internally connected to the NO contact of the Volume Override. So, the NC and the NO contacts determine which voltage is supplied to the positive pins of the override outputs (Z+).

See situation I, for an example of a power-saving 4-wire volume override:

- ▶ Connect the NO contact of the Volume Override to the 24V contact of the Volume Override.

See situation II, for an example of a fail-safe 4-wire volume override:

- ▶ Connect the NC contact of the Volume Override to the 24V contact of the Volume Override.

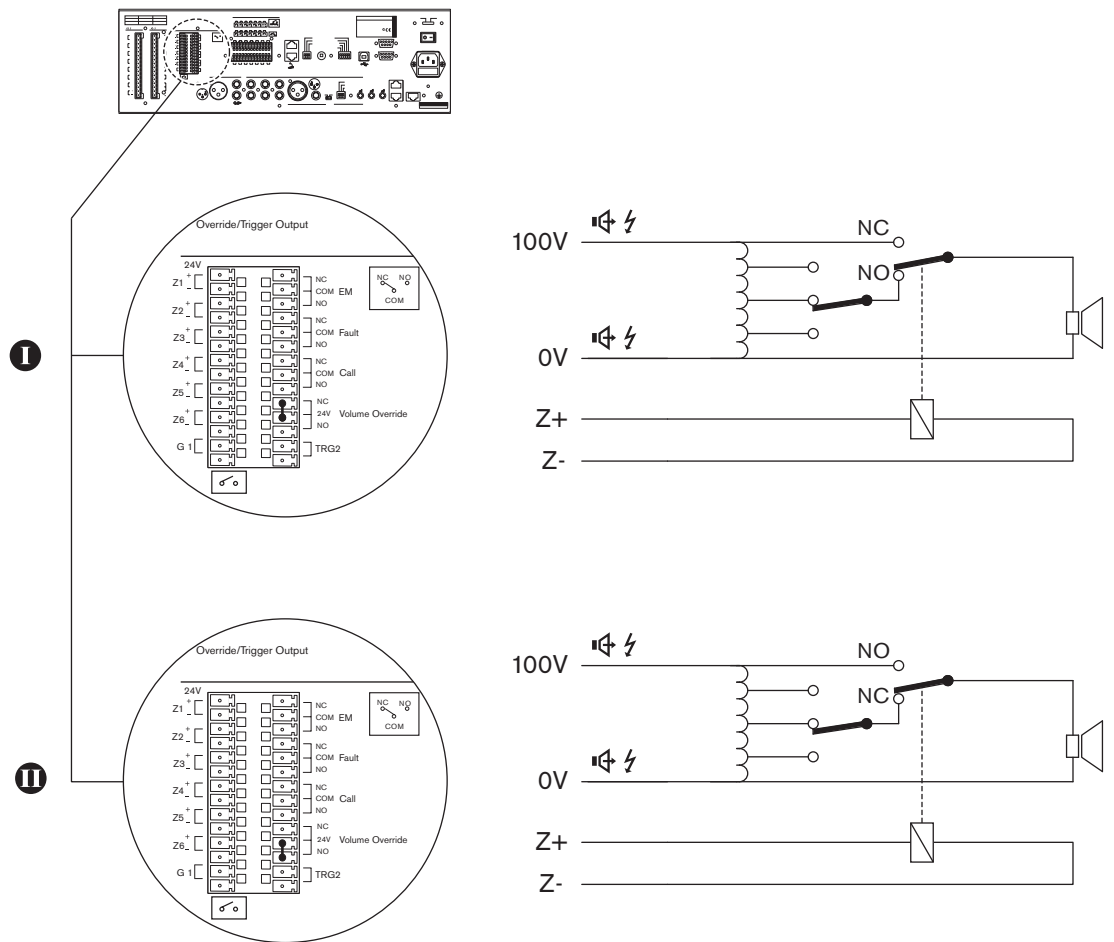

Figure 5.9: 4-wire volume override

To create a 3-wire volume override:



Notice!

It is not possible to use 3-wire volume override in combination with redundant loudspeaker lines (line A and B, see figure 5.6) and supervision. If redundant loudspeaker lines are needed, use 4-wire volume override.

1. Connect the 100 V output of loudspeaker line A to the 100 V input of the volume control.
2. Connect the 100 V/0 V (CALL/RTN) of the transformer to the 100V output of loudspeaker line B.
3. Connect the 0 output of loudspeaker line A to the 0 V of the loudspeaker.

4. Enable 3-wire volume override in the configuration software.

**Notice!**

See the Configuration Software Manual for more information about the configuration software.

**Caution!**

Make sure that the correct connections have been made and the system is correctly configured.

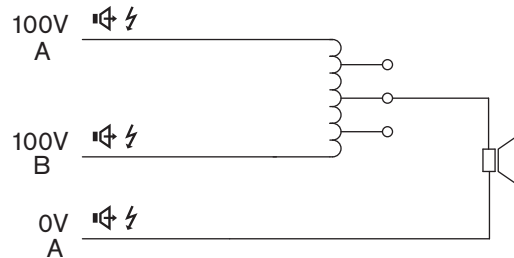

Figure 5.10: 3-wire volume override

5.1.8

Line output

The voice alarm controller has 1 line output. This output has a double cinch socket. Both cinch sockets contain the same, mono signal, which consists of the current BGM and calls. The line output can be used to connect the voice alarm controller to a recording device (e.g. a tape-deck).

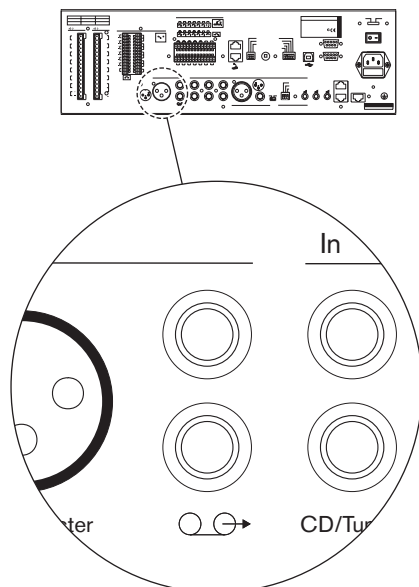

Figure 5.11: Line output

5.1.9

Mic/line input with VOX

The voice alarm controller has 1 mic/line input with voice-activated (VOX) functionality. This input has 2 sockets; a balanced XLR socket and a balanced 6.3 mm jack socket. The signals from both sockets are mixed to form a single input signal.

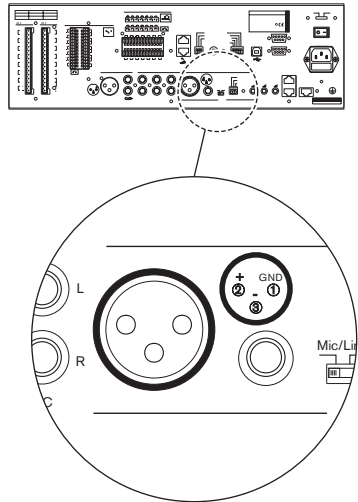

Figure 5.12: Mic/line input with VOX functionality

The input automatically starts a business or emergency call if the input is higher than -10 dB or if the VOX switch is closed. The input must be configured with the configuration software.



Notice!

See the Configuration Software Manual for more information about the configuration software.

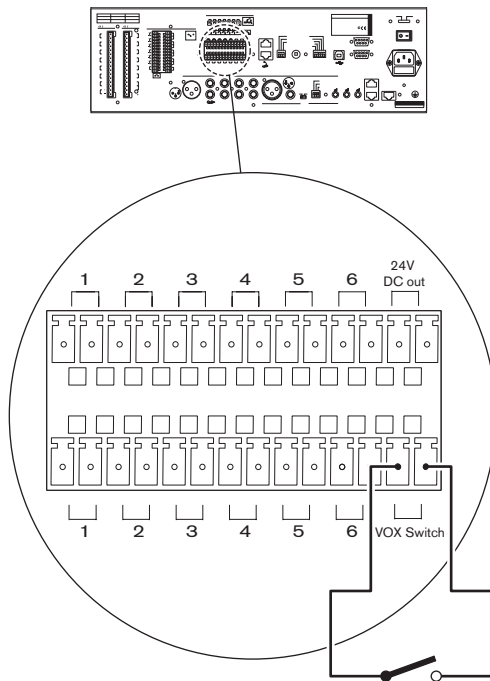

Figure 5.13: Connecting a VOX switch

For example, the mic/line input with VOX functionality can be used to create a supervised link to another emergency sound system (e.g. a Praesideo system).

5.1.10

BGM inputs

The voice alarm controller has 2 BGM inputs. Each BGM input has a double cinch socket. To these cinch outputs, a background music source can be connected (e.g. a Bosch music source). The signals connected to the L (left) and R (right) cinch sockets are mixed to form a single input signal.

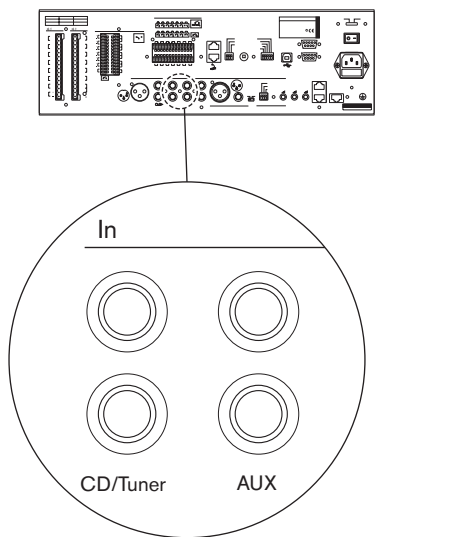

Figure 5.14: BGM inputs

Input	Source
CD/Tuner	CD or tuner
AUX	Auxiliary source

Table 5.1: BGM inputs

5.1.11 Status output contacts

The voice alarm controller has 3 status output contacts to indicate the current system state. These are used to send the status of the Plena Voice Alarm System to third party equipment or to connect sounders or similar indicating devices.

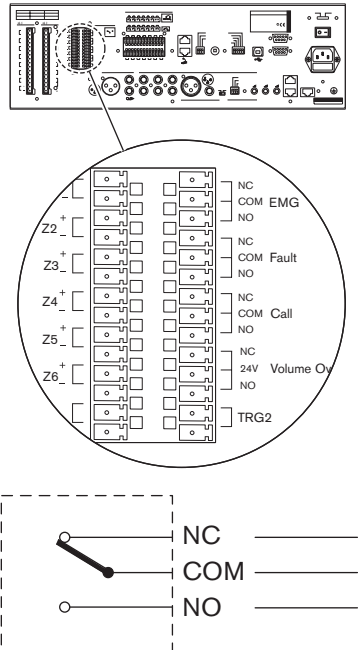

Figure 5.15: Status output contacts (default)

Contact	Description
EMG	Emergency state (see section <i>Emergency state</i> , page 91).
Fault	Fault state (see section <i>Fault State</i> , page 96).
Call	Call active state.

Table 5.2: Status output contact

The status output contacts are internal relays. By default, NC is connected to COM. When the Plena Voice Alarm System enters one of the states that are indicated, the relay connects NO to COM.

5.1.12

Power

Introduction

The voice alarm controller has the following power connections:

- Mains power connection.
- Back-up power connection.

Mains power

Proceed as follows to connect the voice alarm controller to the mains power:

- ▶ Select the local mains voltage using the voltage selector on the rear of the voice alarm controller.

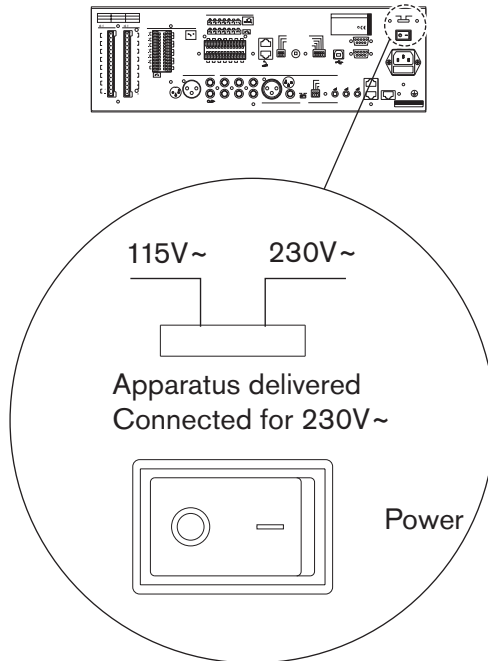

Figure 5.16: Voltage selector

Selector	Mains voltage V(AC)	Fuse
115	100 - 120	115 V - 10 AT
230	220 - 240	230 V - 6,3 AT

Table 5.3: Voltage selector



Notice!

The Voice Alarm Controller is delivered with the voltage selector in the 230 V position.

1. Put the correct type of fuse in the voice alarm controller.



Notice!

The Voice Alarm Controller is delivered with a T6.3L 250 V fuse for a mains voltage of 220 to 240 V(AC).

2. Connect a locally approved mains cord to the voice alarm controller.
3. Connect the mains cord to a locally approved mains outlet.

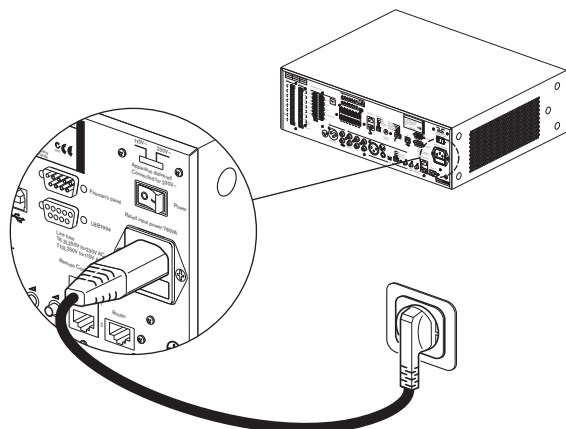

Figure 5.17: Connecting the mains cord

Back-up power

The voice alarm controller has a 24 V(DC) input to connect a back-up power supply (e.g. a battery) which powers the system if the mains power is not available. See the connection details below:

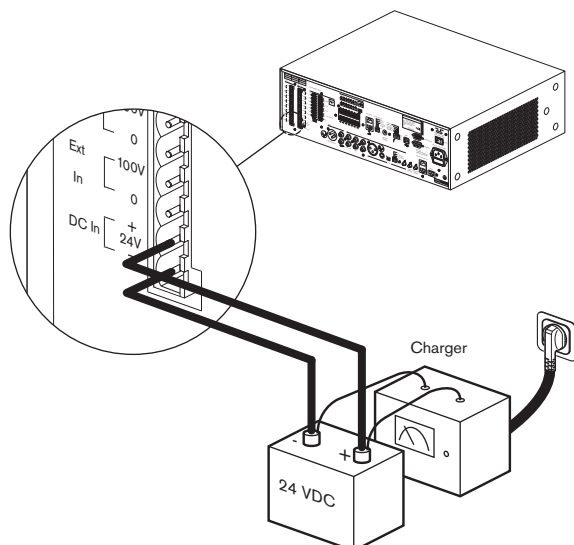

Figure 5.18: Connecting a back-up power supply

5.1.13

Trigger inputs

Introduction

The voice alarm controller has a terminal block to which 6 emergency (EMG) and 6 business trigger inputs can be connected. Third party systems can use the trigger inputs to start emergency and business calls in the Plena Voice Alarm System. The trigger inputs must be configured with the configuration software.

Emergency trigger inputs

The upper part of the terminal block contains the emergency trigger inputs. The emergency trigger inputs have a higher priority than the business trigger inputs.

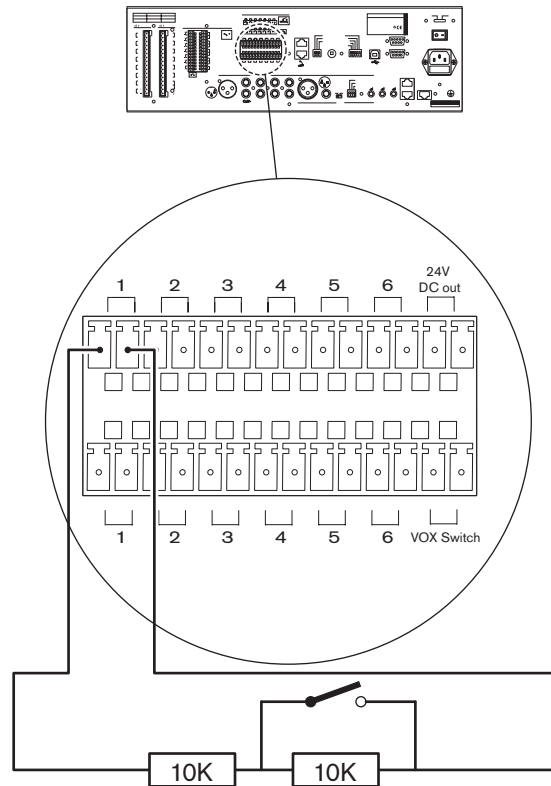

Figure 5.19: Connecting emergency trigger inputs

Business trigger inputs

The lower part of the terminal block contains the business trigger inputs. The business trigger inputs have a lower priority than the emergency trigger inputs.

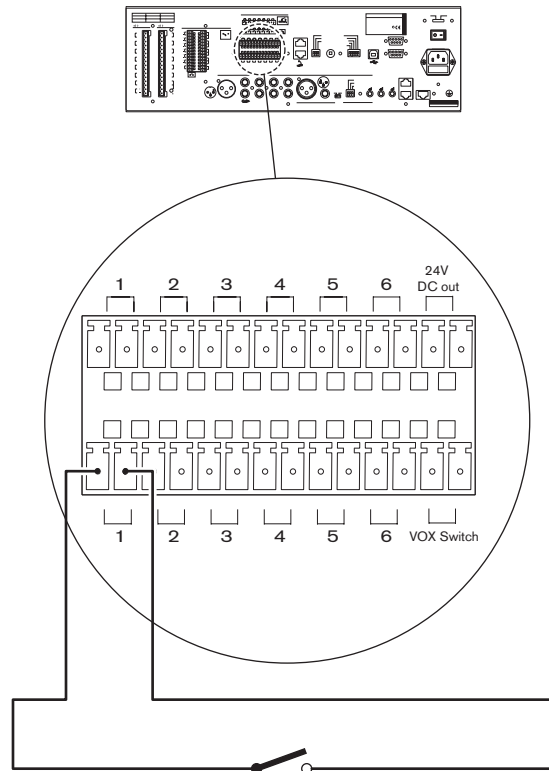

Figure 5.20: Connecting business trigger inputs

5.2 Voice Alarm Router

5.2.1 Voice alarm controller

Connect the voice alarm router to the voice alarm controller (see section *Voice alarm routers*, page 51).

5.2.2 Loudspeakers

The voice alarm router has 6 zone outputs (Z1 to Z6). The procedure for connecting loudspeakers to a voice alarm router is the same as the procedure for connecting loudspeakers to a voice alarm controller (see section *Loudspeakers*, page 54).

5.2.3 Volume overrides

The voice alarm router has 6 override outputs; 1 for each connected zone. These are suitable for 4-wire override (24 V) and for 3-wire override. The procedure for using volume override in zones that are connected to a voice alarm router is the same as the procedure for using volume override in zones that are connected to the voice alarm controller (see section *Volume overrides*, page 56).

5.2.4 Trigger inputs

The voice alarm router has a terminal block to which 6 emergency (EMG) and 6 business trigger inputs can be connected. Third party systems can use the trigger inputs to start emergency and business calls in the Plena Voice Alarm System. The trigger inputs must be configured with the configuration software. The procedure for connecting trigger inputs to a voice alarm router is similar to the procedure for connecting trigger inputs to the voice alarm controller (see section *Trigger inputs*, page 64).

5.2.5 External power amplifiers

The voice alarm router has 2 external power amplifier outputs (line level, 1 V) and 1 external power amplifier input (100 V) to connect two external power amplifiers. The function of the external power amplifier (e.g. a Plena Power Amplifier) depends on the channel mode for which the system is configured (see section 1-Channel mode operation, page 77 and section 2-Channel mode operation, page 78).

See the next information about connecting external power amplifier 1 to a voice alarm router:

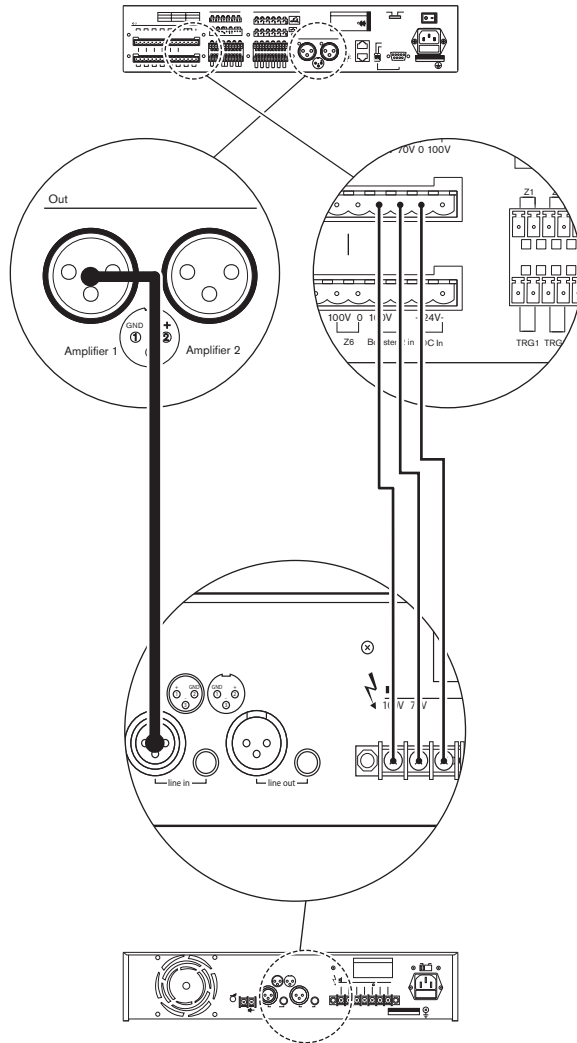

Figure 5.21: Connecting external power amplifier 1

See the next information about connecting external power amplifier 2 to a voice alarm router:

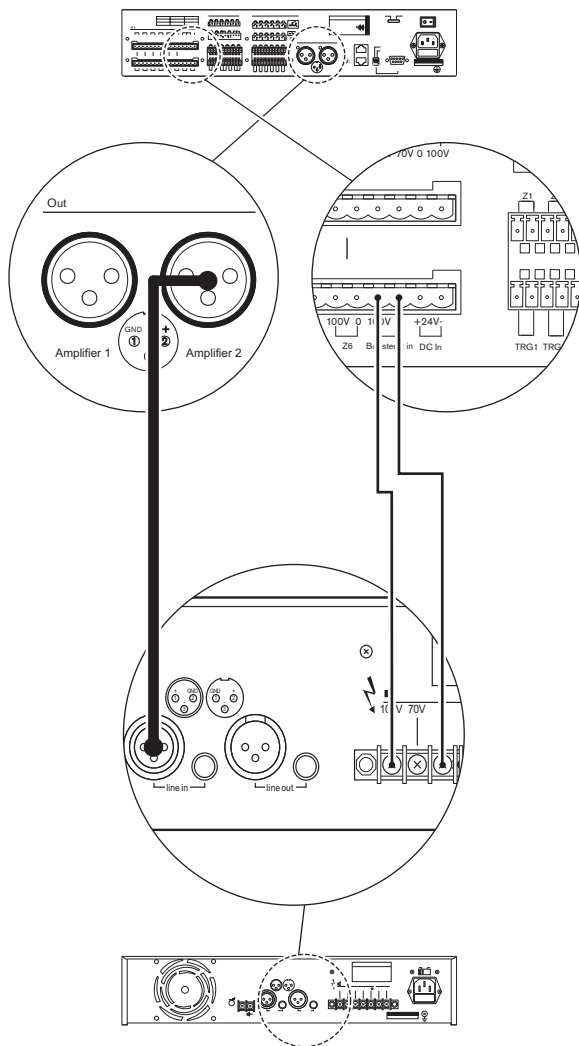

Figure 5.22: Connecting external power amplifier 2



Notice!

The internal power amplifier of the voice alarm controller can also be used as external power amplifier for the voice alarm router.

5.2.6

Power

The procedure for connecting a voice alarm router to the mains power is the same as the procedure for connecting the voice alarm controller to the mains (see section *Power*, page 62).

5.3 Call Station

5.3.1 Voice alarm controller

Connect the call station to the voice alarm controller (see section *Call station*, page 50).

5.3.2 Power supply

If the cable between the voice alarm controller or the previous call station is longer than 100 m, the call station may sometimes need to be connected to a 24 V(DC) power source. See the connection details below:

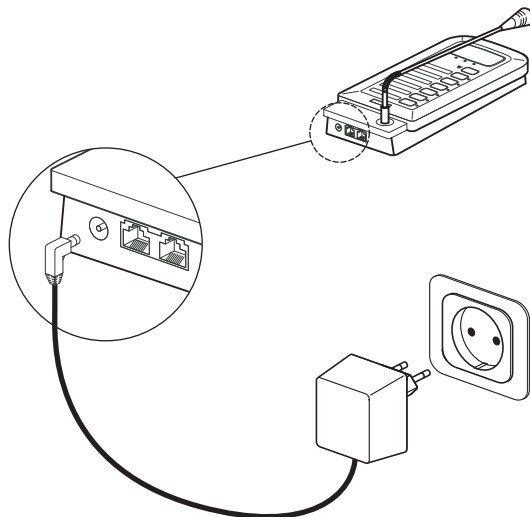

Figure 5.23: Connecting a power supply

5.3.3 Keypads

The maximum number of keypads that can be connected to a call station is 8 (see section *Call Station Keypad*, page 44).

5.4 Voice Alarm Remote Control

5.4.1 Voice alarm controller

Connect the remote control panel to the voice alarm controller (see section *Remote controls*, page 53).

5.4.2 Remote control extensions

The remote controller has 1 socket for remote control extensions (Remote Control Extension, Remote Control Extension kit). Use shielded CAT-5 Ethernet cables with RJ45 plugs to connect a remote control extension to the remote control. When the system requires more than 1 remote control extension, use the system sockets on the remote control extension to make loop-throughs. See the connection details below.

The termination switch must be set to ON. If not, over long distances, the data bus can malfunction.

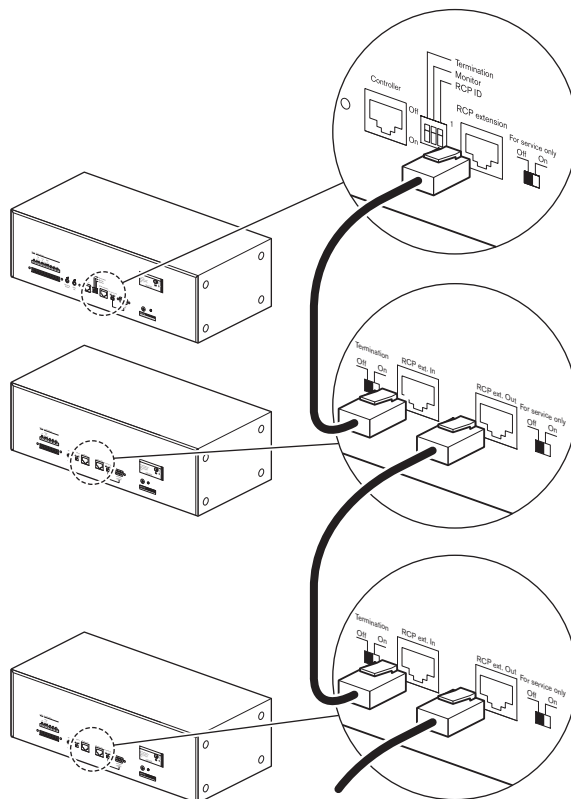

Figure 5.24: Connecting remote control extensions

5.4.3 Status output contacts

The remote control panel has 3 status output contacts to indicate the current system state. The procedure for connecting the status outputs is the same as the procedure for connecting status outputs to the voice alarm controller (see section *Status output contacts*, page 61).

5.4.4

Power

Connect a power supply to the remote control panel:

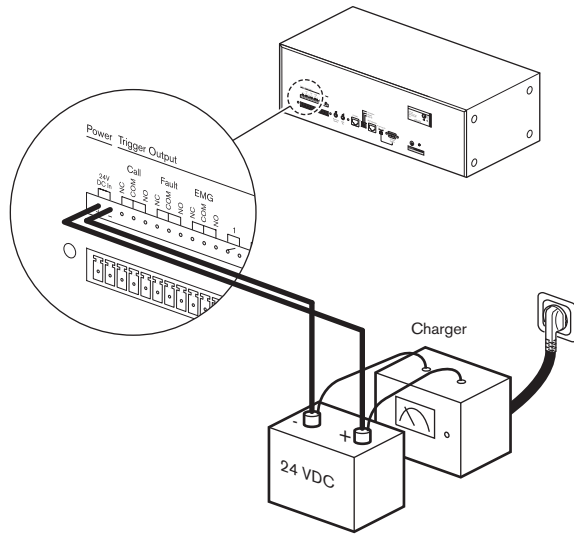

Figure 5.25: Connecting a 24 VDC power supply

5.5

Voice Alarm Remote Control Kit

5.5.1

Rear panel

The rear panel of the remote control kit has the same connectors and controls as the rear panel of the Voice Alarm Remote Control. See section *Voice Alarm Remote Control*, page 70 for connection details.

5.5.2

LEDs

To the LEDS/LAMPS connectors on the front panel of the remote control kit, the LEDs can be connected.

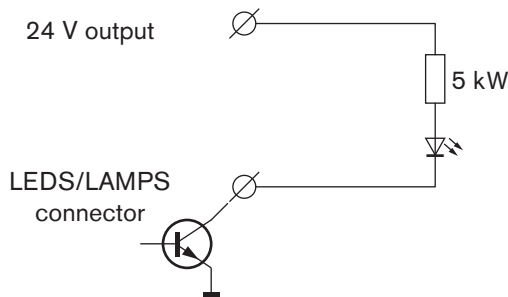

Figure 5.26: Connecting LEDs

5.5.3

Lamps

To the LEADS/LAMPS connectors on the front panel of the remote control kit, lamps can be connected:

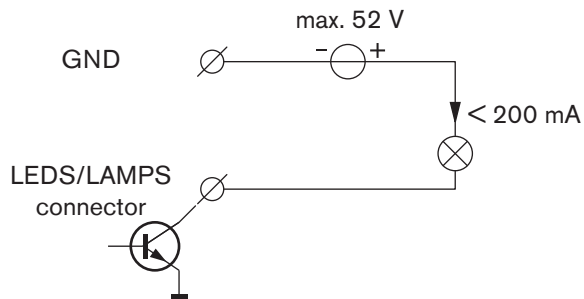

Figure 5.27: Connecting lamps

5.5.4

Relays

To the LEADS/LAMPS connectors on the front panel of the remote control kit, relays can be connected:

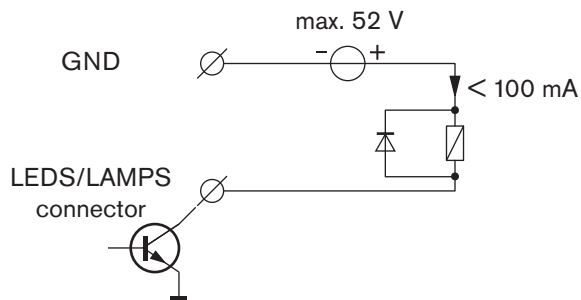

Figure 5.28: Connecting relays

5.6 Remote Control Extension

5.6.1 Remote control

Connect the remote control extension to the remote control (see section *Remote control extensions*, page 70).

5.6.2 Status output contacts

The remote control extension has 3 status output contacts to indicate the current system state. The procedure for connecting the status outputs is the same as the procedure for connecting status outputs to the voice alarm controller (see section *Status output contacts*, page 61).

5.6.3 Power

Connect a back-up power supply to the remote control extension.

The 24 V output of the Controller or the Router can be used for this. Those outputs are powered by mains and back-up power. It is also possible to install a floating (without ground reference) 24 V power supply with backup battery (EN54-4 compliant for EN54-16 compliant systems, or EN60849 compliant).

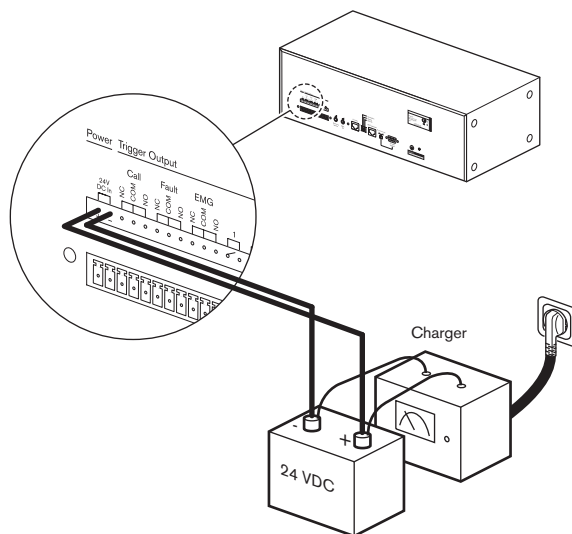

Figure 5.29: Connecting a power supply

5.7 Remote Control Extension Kit

5.7.1 Rear panel

The rear panel of the remote control extension kit has the same connectors and controls as the rear panel of the Voice Alarm Control Extension. See section *Remote Control Extension*, page 73 for connection details.

5.7.2 LEDs

To the LEDs/LAMPS connectors on the front panel of the remote control extension kit, the LEDs can be connected (see *Voice Alarm Remote Control kit*, page 27).

5.7.3 Lamps

To the LEDs/LAMPS connectors on the front panel of the remote control extension kit, lamps can be connected (see *Voice Alarm Remote Control kit*, page 27).

5.7.4

Relays

To the LEDs/LAMPS connectors on the front panel of the remote control extension kit, relays can be connected (see *Voice Alarm Remote Control kit, page 27*).

5.8

Fireman's Panel

5.8.1

Voice alarm controller

Connect the fireman's panel to the voice alarm controller (see section *Remote controls, page 53*).

5.8.2

Remote control extensions

The fireman's panel has 1 socket for remote control extensions (Remote Control Extension, Remote Control Extension kit). Use shielded CAT-5 Ethernet cables with RJ45 plugs to connect a remote control extension to the fireman's panel. When the system requires more than 1 remote control extension, use the system sockets on the remote control extension to make loop-throughs. See section *Remote control extensions, page 70* for connection details.

5.8.3

Status output contacts

The fireman's panel has 3 status output contacts to indicate the current system state. The procedure for connecting the status outputs is the same as the procedure for connecting status outputs to the voice alarm controller (see section *Status output contacts, page 61*).

5.8.4

Power

The procedure for connecting a fireman's panel to a power supply is the same as the procedure for connecting a remote control to a power supply (see section *Power, page 71*).

6 Configuration

A number of functions of the Plena Voice Alarm System is hardware configured using, for example, DIP switches and volume controls. Other parts of the system must be software configured using the Plena Voice Alarm System configuration software. A description of this software is beyond the scope of this manual. This manual only describe the hardware configuration of a Plena Voice Alarm System.



Notice!

See the Configuration Software Manual for more information about the configuration software.

It is recommended to do the hardware configuration of the system before the software configuration.

6.1 System settings

The system settings are configured using DIP switches on the rear of the voice alarm controller. By default, all switches are in the OFF position.

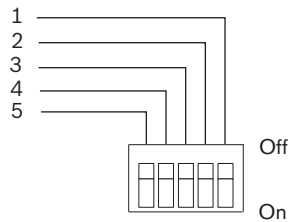

Figure 6.1: System settings DIP switches

No	DIP switch	Description
1	Monitor	Switches the monitoring loudspeaker on (ON) and off (OFF). See section <i>Monitor</i> , page 76.
2	APR mode	Switches the Asian Pacific Region mode on (ON) and off (OFF). See section <i>APR mode</i> , page 76.
3	Supervision	Switches supervision on (ON) and off (OFF). See section <i>Supervision</i> , page 76.
4	2ch operation	Switches 2-channel operation on (ON) and off (OFF). See section <i>1-Channel mode operation</i> , page 77 and section <i>2-Channel mode operation</i> , page 78.
5	Reserved	Reserved. This DIP switch must always be in the OFF position.

Table 6.1: System settings DIP switches

6.1.1 Monitor

If the Monitor switch is in the ON position, the internal monitoring loudspeaker of the voice alarm controller is switched on. The volume of the monitoring loudspeaker is set with the Monitoring Speaker volume control (see *Controls, connectors and indicators, page 14, no. 36*).

6.1.2 APR mode

If the APR mode switch is in the ON position, the system is in the Asian-Pacific Region (APR) mode. In APR mode, the system operates according to the emergency standards of the Asian-Pacific Region. In the APR mode:

- The priority level of the emergency trigger inputs is always 14.
- Emergency and business trigger inputs of the same zone form pairs. The settings of the emergency trigger input (software configurable) apply to both.
- The emergency trigger inputs are never supervised.
- When an emergency trigger input is activated, the system enters the emergency state. The voice alarm controller also automatically starts a pre-emergency announcement and alarm message (software configurable).
- When a business trigger input is activated, the system enters the emergency state. The voice alarm controller does not automatically start a pre-emergency announcement and alarm message.
- The red LED, which during normal operation indicates that the zone is selected for an emergency call (see *Controls, connectors and indicators, page 14, no. 5*), indicates that an emergency trigger input is active.
- The green LED, which during normal operation indicates that a business call is running in the zone (see *Controls, connectors and indicators, page 14, no. 5*), indicates that an emergency call is running in the zone.
- The priority level of the emergency microphone of the voice alarm controller is always 16.
- When the emergency button (see *Controls, connectors and indicators, page 14, no. 12*) is pushed on the front of the voice alarm controller, an alarm message is automatically started. This message is automatically repeated.

6.1.3 Supervision

If the Supervision switch (see *System settings, page 75*) is in the ON position, supervision is enabled. If it is in the OFF position, supervision is disabled. See section *Supervision, page 78* for more information about supervision.

6.1.4 1-Channel mode operation

If the 2ch operation switch (see *2-Channel mode operation, page 78*) is in the OFF position, the system operates in the 1-channel mode.

Voice alarm controller

In the 1-channel mode, all calls and BGM are amplified by the internal power amplifier of the voice alarm controller. If desired, an external power amplifier can be connected for spare switching (see section *External power amplifier, page 52*). In 1-channel mode, all calls will interrupt the BGM.

Amplifier	Function
Internal	BGM/Call power amplifier.
External	Not connected/Spare power amplifier.

Table 6.2: 1-channel mode, voice alarm controller

Voice alarm router

One or two external power amplifiers can be connected to a voice alarm router to increase the power of the system (see section *External power amplifiers, page 67*). In 1-channel mode:

- External power amplifier 1 of the voice alarm router is used to increase the power for calls and BGM, that go via the internal power amplifier of the voice alarm controller.
- External power amplifier 2 of the voice alarm router is used for spare-switching.

Amplifier	Function
1	BGM/Call power amplifier.
2	Not connected/Spare power amplifier.

Table 6.3: 1-channel mode, voice alarm router

6.1.5 2-Channel mode operation

If the 2ch operation switch (see *System settings, page 75*) is in the ON position, the system operates in the 2-channel mode.

Voice alarm controller

In the 2-channel mode, the BGM is amplified by the internal power amplifier of the voice alarm controller. The calls are amplified by the external power amplifier, which is connected to the voice alarm controller (see section *External power amplifier, page 52*). If the external power amplifier is faulty, the calls are amplified by the internal power amplifier. In 2-channel mode, calls do not interrupt the BGM.

Amplifier	Function
Internal	BGM/Spare power amplifier.
External	Call power amplifier.

Table 6.4: 2-channel mode, controller

Voice alarm router

One or two external power amplifiers can be connected to a voice alarm router to increase the power of the system (see section *External power amplifiers, page 67*). In 2-channel mode:

- External power amplifier 1 of the voice alarm router is used to increase the power of the internal power amplifier of the voice alarm controller.
- External power amplifier 2 of the voice alarm router is used to help the external power amplifier of the voice alarm controller to amplify calls.

Amplifier	Function
1	BGM/Spare power amplifier.
2	Call power amplifier.

Table 6.5: 2-channel mode, router

6.2 Supervision

If the Supervision switch (see *System settings, page 75*) is in the ON position, supervision is enabled. If it is in the OFF position, supervision is disabled.



Notice!

Supervision is only necessary for systems that have to comply to the IEC60849 evacuation standard. If the system does not have to comply to this standard, leave the switch in the OFF position.

If the Supervision switch is in the OFF position, the Disabled indicator on the front panel of the voice alarm controller is lit to indicate that supervision is switched off.

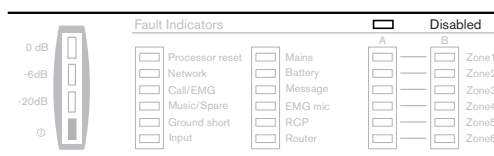

Figure 6.2: Disabled indicator

If the Supervision switch is in the ON position, an indicator is lit when a supervised function fails (see section *Fault State, page 96*). Use the configuration software to switch supervised functions on and off.

**Notice!**

See the Configuration Software Manual for more information about the configuration software.

6.2.1**Processor reset****Watchdog**

If supervision is enabled (see section *Supervision, page 78*), the processor of the voice alarm controller is supervised by a watchdog. If the watchdog triggers, the Processor reset indicator on the front panel of the voice alarm controller is lit. Then, the program memory is checked and the processor resumes operation within 10 seconds. The indicator remains on until the fault is acknowledged and reset.

New firmware

A processor reset sometimes happens after new firmware is installed. make sure the Service DIP switches are put back to the correct position. The correct positions are:

- SEL0 and SEL1 to ON.
- Enable Firmware Download to OFF.

6.2.2**Network**

If supervision is enabled and network supervision is switched on (see section *Supervision, page 78*), the connections from the voice alarm controller to the voice alarm routers and remote controls are supervised. When any voice alarm router or remote control is missing during a network check, a network error is reported.

6.2.3**Power amplifiers**

If supervision is enabled and call power amplifier supervision is switched on (see section *Supervision, page 78*), the call power amplifiers in the system are supervised. In the configuration software, mark the checkbox Call/EMG to enable this function.

If supervision is enabled and BGM/Spare power amplifier supervision is switched on (see section *Supervision, page 78*), the BGM and spare power amplifiers in the system are supervised. In the configuration software, mark the checkbox Spare to enable this function.

6.2.4**Ground short**

If supervision is enabled and ground short supervision is switched on (see section *Supervision, page 78*), the system can continuously monitor loudspeaker lines in the system for short-to-ground situations. For each loudspeaker line, short-to-ground supervision can be switched on and off with the configuration software.

**Notice!**

See the Configuration Software Manual for more information about the configuration software.

If a leakage current $> 30 + 15$ mA is detected in a line, the line is considered faulty.

6.2.5 Emergency trigger inputs

If supervision is enabled and input supervision is switched on (see section *Supervision*, page 78), the system can supervise the emergency trigger inputs. For each emergency trigger input, supervision can be switched on and off with the configuration software.



Notice!

See the Configuration Software Manual for more information about the configuration software.

6.2.6 Mains power

If supervision is enabled and mains power supervision is switched on (see section *Supervision*, page 78), the availability of the mains power is supervised.

6.2.7 Battery

If supervision is enabled and battery supervision is switched on (see section *Supervision*, page 78), the availability of the back-up power is supervised.

6.2.8 Message supervision

If supervision is enabled and message supervision is switched on (see section *Supervision*, page 78), the internal message manager of the voice alarm controller is supervised. This message supervision consists of supervision of the wave player using a check-sum and supervision of the audio path using a pilot-tone.

6.2.9 Emergency microphone

If supervision is enabled and emergency microphone supervision is switched on (see section *Supervision*, page 78), the audio path and the PTT switch of the emergency microphone are monitored from the capsule to the connection with the voice alarm controller.

6.2.10 Line supervision

If supervision is enabled and line supervision (see section *Supervision*, page 78) is switched on, all loudspeaker lines are supervised. Line supervision consists of:

- Impedance supervision.
- Short-to-ground supervision.

Impedance supervision

If line supervision is switched on, the voice alarm controller measures the impedance of all loudspeaker lines once every 90 seconds (default value). The reference values for impedance supervision are stored in the voice alarm controller during the system calibration (see section *Calibration*, page 87). If a difference of > 15% (default value) is detected between the measured line impedance and its reference value, the line is considered faulty. The default values can be changed with the configuration software.



Notice!

A small click can be heard at the start and end of an impedance measurement. If the click is unacceptable, then end of line supervision with EOL can be considered instead of impedance supervision.



Notice!

See the Configuration Software Manual for more information about the configuration software.

Short-circuit supervision

If line supervision is switched on, the voice alarm controller continuously monitors all loudspeaker lines in the system for short-circuits.

If a short-circuit is detected, the line output of the short-circuited line is isolated and shut down within 200 ms. The system will remain operational. If the line is dual-redundant connected (A and B), the short-circuited line remains operational as well.

When a ground short occurs, first check the 0 V and 100 V connections from the amplifier to the Voice Alarm Controller. If these connections are incorrect, then a short fault can occur at unpredictable times.

6.3 Voice alarm controller

6.3.1 VOX configuration

The type of source that is connected to the mic/line input with VOX functionality is set using the Mic/Line switch on the rear of the voice alarm controller.

- If the source is a microphone, put the switch in the Mic. position.
- If the source is a line-level source, put the switch in the Line position.



Figure 6.3: VOX input source switch

The mic/line input with VOX functionality is configured using DIP switches on the rear of the voice alarm controller. By default, all switches are in the OFF position.

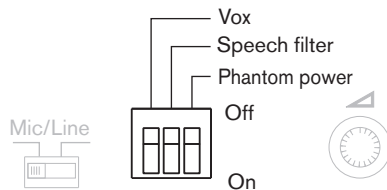

Figure 6.4: VOX settings

The settings that can be made using the DIP switches are explained in a table on the rear of the voice alarm controller (see the following table).

	Off	On
1	VOX activated by mic.	VOX activated by VOX switch.
2	Speech filter.	Flat.
3	Phantom power Off.	Phantom power On.

Table 6.6: Vox settings

The volume of the mic/line input with VOX functionality is set with the VOX volume control.



Figure 6.5: VOX volume control

6.3.2

VOX

If the VOX switch is in the OFF position, the input is activated when the voltage of the signal of the source is above the specified threshold. If the VOX switch is in the ON position, the input is activated when the VOX Switch trigger input is closed (see also section *Mic/line input with VOX*, page 59).

6.3.3

Speech filter

If the Speech filter switch is in the OFF position, a speech filter is activated for the mic./line input with VOX functionality. The speech filter improves the speech intelligibility by cutting off the lower frequencies.

6.3.4

Phantom power

If the Phantom power switch is in the ON position, a phantom power supply is activated. This switch only has to be put in the ON position if the source is a microphone that must receive phantom power. If the source is not a microphone or if the microphone does not accept phantom power, leave the switch in the OFF position.

6.3.5

Voice alarm router

The voice alarm routers are configured using an ID selector and a DIP switch:

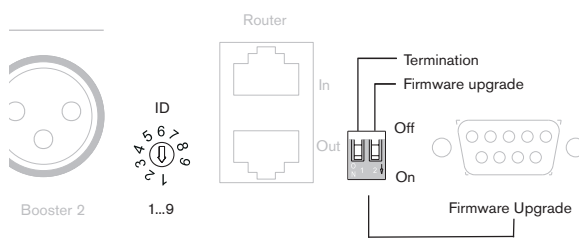

Figure 6.6: Router settings

6.3.6

Router ID

The ID of the voice alarm router is set using an ID selector (17). Each voice alarm router must have a unique ID (1 to 19). Use a small screwdriver to turn the arrow in the correct position. The DIP switch (15) has 3 switches. The first switch (left) determines whether the router has address 0x (1 to 9) or 1x (10 to 19).



Notice!

The switch “Firmware upgrade” must be set to “ON” to execute the firmware upgrade. When the upgrade is complete, the switch must be set back to “OFF”.

6.3.7

Termination switch

The last voice alarm router in a sequence of looped-through routers must always be terminated. Only for these voice alarm routers, put the Termination switch in the ON position.

6.4 Call station

The call stations are configured using the DIP switch at the bottom:

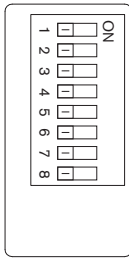

Figure 6.7: Call station DIP switches

DIP switch	Description
1, 2, 3, 4	Set the ID of the call station. See section <i>Call station ID</i> , page 83.
5, 6	Set the sensitivity of the call station. See section <i>Sensitivity</i> , page 83.
7	Switches the speech filter on (ON) and off (OFF). See section <i>Speech filter</i> , page 84.
8	Switches termination on (ON) and off (OFF). See section <i>Termination</i> , page 84.

Table 6.7: Call station DIP switches

6.4.1 Call station ID

The ID of the call station is set using switches 1 to 4. Each call station must have a unique ID (1 to 9).

6.4.2 Sensitivity

The sensitivity of the call station is set using switches 5 and 6:

Sensitivity	Switch 5	Switch 6
-15 dB	OFF	OFF
0 dB	OFF	ON
6 dB	ON	OFF
Reserved	ON	ON

Table 6.8: Call station sensitivity

6.4.3**Speech filter**

If switch 7 is in the ON position, a speech filter is activated for the call station. The speech filter improves the speech intelligibility by cutting off the lower frequencies.

6.4.4**Termination**

The last call station in a sequence of looped-through call stations must always be terminated. Only for these call stations, put switch 8 in the ON position.

**Notice!**

The Controller comes with a termination plug (RJ45). Plug this connector in the unused RJ45 socket.

6.5 Remote control

The remote controls are configured using a DIP switch:

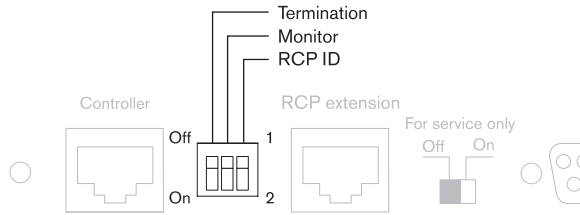

Figure 6.8: Remote control settings

6.5.1 Remote control ID

The ID of the remote control is set using the Remote Control Panel ID switch. The ID of the remote control must be the same as the number of the RCP connection of the voice alarm controller to which the remote control is connected (1 to 2). Actions that are started by the remote control with ID 1 have a higher priority than actions that are started by the remote control with ID 2.

6.5.2 Monitor

If the Monitor switch is in the ON position, the internal monitoring loudspeaker of the remote control is switched on. The volume of the monitoring loudspeaker is set with the Monitoring Speaker volume control on the rear panel of the remote control.

6.5.3 Termination switch

If there are no remote control extensions connected to the remote control, the termination switch must be in the ON position.

6.6 Remote control extension

The remote control extensions are configured using an ID selector and a switch:

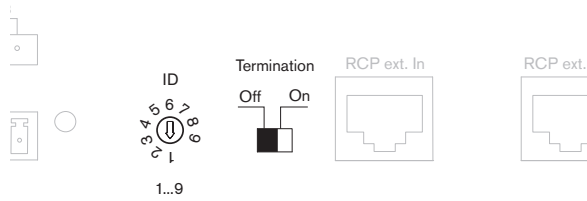

Figure 6.9: Remote control settings

6.6.1 Remote control extension ID

The ID of the remote control extension is set using a ID selector. The remote control extension only controls the voice alarm router that has the same ID. Furthermore, each remote control extension that is connected to the same remote control must have a unique ID.

6.6.2 Termination switch

The last remote control extension in a sequence of looped-through remote control extensions must always be terminated. Only for these remote control extensions, put the termination switch in the ON position.



Notice!

The Controller comes with a termination plug (RJ45). Plug this connector in the unused RJ45 socket.

7 Operation

7.1 Switch on



Notice!

It is assumed that the APR mode switch (see section *APR mode*, page 76) is in the OFF position.

7.1.1 Voice alarm controller

Switch on

Put the power switch on the rear of the voice alarm controller in the I position.

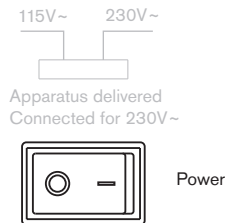

Figure 7.1: Power switch

If mains power or back-up power is available, the power indicator on the front of the voice alarm controller is lit. If the system contains call stations, the power indicator of the call stations are also lit (see *Controls, connectors and indicators*, page 23, no. 1). Furthermore, all connected remote controls and remote control extensions are switched on by the voice alarm controller.

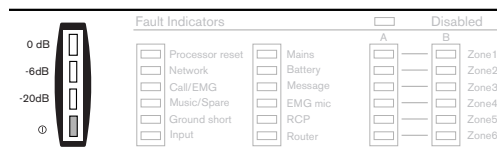

Figure 7.2: Power indicator



Notice!

When the system is switched on for the first time and supervision is enabled, calibrate the system (see section *Calibration*, page 87).

7.1.2 Voice alarm router

Switch on

Put the power switch on the rear of the voice alarm router in the I position.

7.1.3 Calibration

Calibration is necessary for a correct loudspeaker line impedance supervision (see section *Line supervision*, page 80). To calibrate the system, push the calibration switch on the rear of the voice alarm controller (see *Controls, connectors and indicators*, page 14, no. 24). The system must be calibrated:

- When the voice alarm controller is switched on for the first time.
- When a voice alarm router is switched on for the first time.
- After the connected loudspeakers are changed.
- After loudspeakers have been added or removed.

- After the settings of the connected loudspeakers have been changed.

7.2 Background music

The background music (BGM) is controlled using the BGM controls on the front of the voice alarm controller, voice alarm router and their remote control and remote control extensions. Proceed as follows to route BGM:

1. Select the BGM source (see section *Select BGM source*, page 88).
2. Select the zones (see section *Select zones*, page 88).

7.2.1 Select BGM source

Select the BGM source with the Select button on the front of the voice alarm controller. A green LED indicates the source that is selected.

- If the source is a CD player or a tuner that is connected to the CD/Tuner input, choose CD/Tuner.
- If the source is an auxiliary source that is connected to the Aux input, choose Aux.

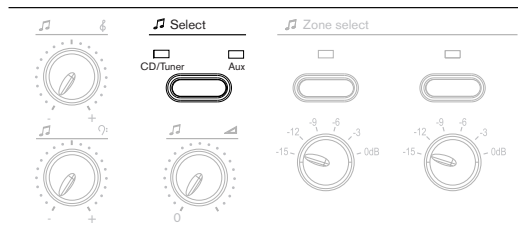

Figure 7.3: BGM source selector

7.2.2 Select zones

The BGM is distributed to the zones with the Zone select buttons on the voice alarm controller, voice alarm router, remote controls and remote control extensions. A green LED indicates the zones to which BGM is distributed.

- If the Zone select indicator is off, no BGM is distributed to the zone. Push the Zone select button to distribute the BGM to the zone.
- If the Zone select indicator is on, BGM is distributed to the zone. Push the Zone select button to stop distributing the BGM to the zone.

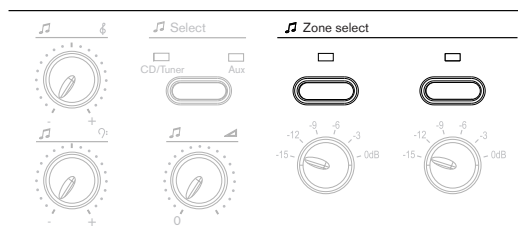

Figure 7.4: BGM zone selector

7.2.3

Adjust volume

The voice alarm controller has two types of controls to adjust the BGM volume. The overall (maximum) volume of the BGM source is set with the master volume control, which is located below the BGM source selector (Select button, see *Select BGM source*, page 88). Per zone that is connected to the voice alarm controller, the local volume can be adjusted with the zone volume switches, which are located below the zone selection buttons (Zone select, see *Select zones*, page 88). Each zone volume switch has six settings, ranging between 0 dB and -15 dB.

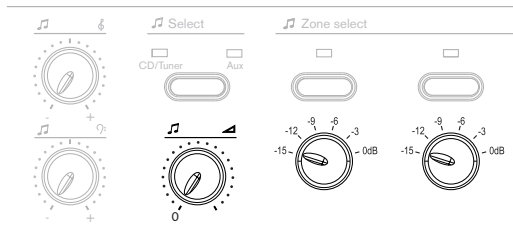

Figure 7.5: BGM volume controls

The local volume in the zones that are connected to voice alarm routers must be adjusted using local volume controls that must be connected to the loudspeaker line of each individual zone.

7.2.4

Adjust frequencies

The voice alarm controller has two rotary knobs to adjust the sound of the BGM.

- Use the upper rotary knob to adjust the treble or high frequency content of the BGM.
- Use the lower rotary knob to adjust the bass or low frequency content of the BGM.

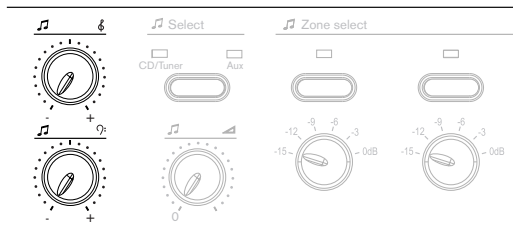

Figure 7.6: BGM tone controls

7.3

Business calls

Business calls can only be distributed with call stations. It is not possible to use a hand-held emergency microphone to distribute business calls. Proceed as follows to distribute a business call:

1. Select the zones (see section *Select zones*, page 90).
2. Make the announcement (see section *Make the announcement*, page 90).



Notice!

It is also possible to distribute business calls using business trigger inputs. When an business trigger input is activated, the system automatically takes the action that is programmed with the configuration software.

**Notice!**

See the Configuration Software Manual for more information about the configuration software.

7.3.1**Select zones**

Select the zones to which the business call must be distributed with the zone selection buttons on the call station or its keypads. A green LED indicates the zones to which the business call is distributed.

- If the indicator of a button is off, the zone is not selected. Push the button to select the zone.
- If the indicator of a button is on, the zone is selected. Push the button to deselect the zone.

**Notice!**

The zone selection buttons of the call stations and call station keypads must be configured with the configuration software.

**Notice!**

See the Configuration Software Manual for more information about the configuration software.

7.3.2**Make the announcement**

Push the push-to-talk (PTT) button of the call station to make an announcement. The call is only distributed to the selected zones.

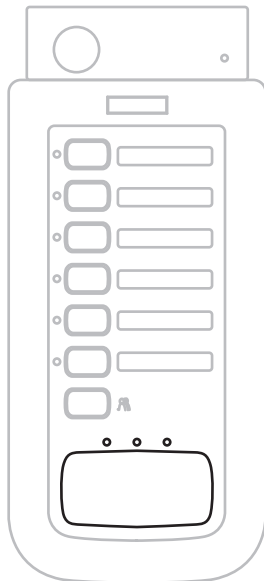

Figure 7.7: PTT button and indicators

The LEDs above the PTT button provide information about the status of the call station.

Indicator	Position	Description
Yellow	Left	System fault
Green	Center	Talk (green). Busy (Yellow flashing).
Red	Right	System in emergency state, call station disabled

Table 7.1: Call station status indicators

7.4 Emergency state

Emergency calls can only be distributed when the system is in the emergency state. See section *Enter the emergency state, page 91* for information about entering the emergency state. In the emergency state, it is possible to distribute the following emergency calls:

- Live speech with the emergency microphone of the voice alarm controller or remote controls (see section *Distribute live speech, page 92*).



Notice!

It is not possible to distribute chimes or speech with the call station when the system is in the emergency state, because the call station is disabled automatically at the moment that the system enters the emergency state.

- The default alert message (see section *Distribute the alert message, page 94*).
- The default alarm message (see section *Distribute the alarm message, page 96*).



Notice!

It is also possible to distribute emergency calls using emergency trigger inputs. When an emergency trigger input is activated, the system automatically enters the emergency state and takes the action that is programmed with the configuration software.



Notice!

See the Configuration Software Manual for more information about the configuration software.

7.4.1

Enter the emergency state

To enter the emergency state, push the emergency button on the front of the voice alarm controller or the remote controls. The red LED that is integrated in the switch lights. The emergency state can also be entered by pushing the Emergency button on the fireman's panel.

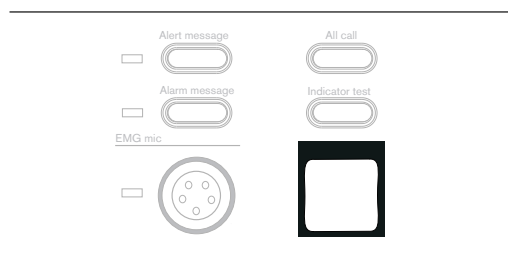

Figure 7.8: Emergency button

At the moment the emergency state is entered, a beeper starts and the EMG status output contact are closed. See section *Exit the emergency state*, page 92 for information about exiting the emergency state.

7.4.2 Acknowledge the emergency state

The beeper can be switched off by acknowledging the emergency state with the EMG Ack button on the voice alarm controller or the remote controls. The beeper can also be switched off by acknowledging the emergency state with the Emergency Acknowledge button on the fireman's panel.

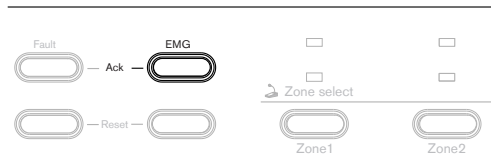

Figure 7.9: EMG Ack button

7.4.3 Exit the emergency state

Exit (reset) the emergency state by pushing the EMG Reset button on the voice alarm controller or the remote controls. The emergency state can also be reset with the Emergency Reset button on the fireman's panel. In order to reset the emergency state, it first must be acknowledged (see section *Acknowledge the emergency state*, page 92).

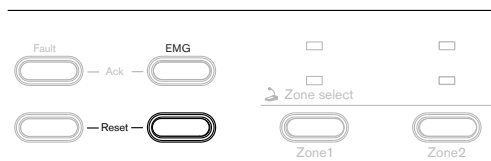

Figure 7.10: EMG Reset button

7.4.4 Distribute live speech

Proceed as follows to distribute live speech:

1. Select zones (see section *Select zones*, page 93).
2. Make announcement (see section *Make the announcement*, page 94).

7.4.5

Select zones

Select the zones to which the live speech must be distributed with the Zone select buttons on the front of the voice alarm controller or the remote controls. A red LED indicates the zones to which the live speech is distributed.

- If the indicator of a Zone select button is off, the zone is not selected. Push the button to select the zone.
- If the indicator of a Zone select button is on, the zone is selected. Push the button to deselect the zone.



Notice!

If no additional action is taken within 10 seconds after the last Zone select button has been pushed (for example closing the PTT switch), the zone selection is cancelled.

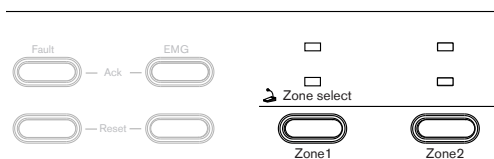

Figure 7.11: Zone select buttons

To select all zones, push the All call buttons on the front of the voice alarm controller or the remote controls.

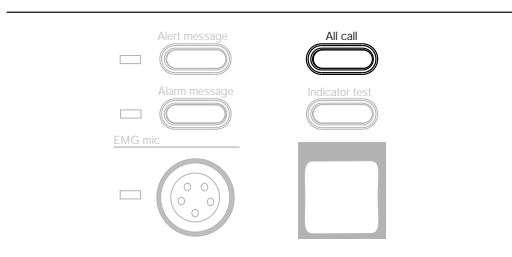

Figure 7.12: All call button

7.4.6

Make the announcement

Push the push-to-talk (PTT) button of the emergency microphone to make an announcement. The live speech is only distributed to the selected zones (see section *Select zones*, page 93). At the moment the PTT button of the emergency microphone is pushed:

- The red EMG mic indicator is lit.
- If they are currently distributed, the default alert message and default alarm message are stopped.



Notice!

If no zones have been selected, the live speech is automatically distributed to all zones in the system.

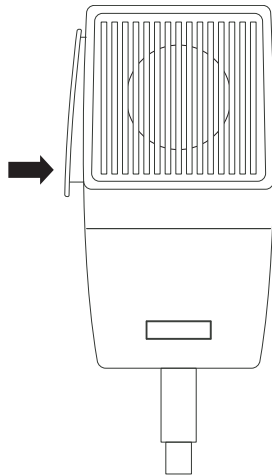

Figure 7.13: Emergency microphone

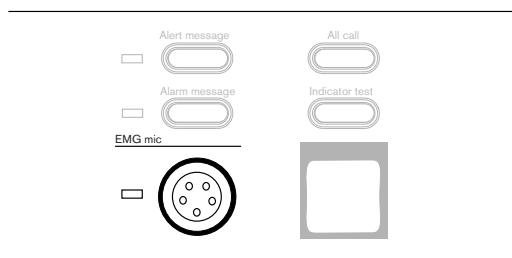

Figure 7.14: Emergency microphone indicator

7.4.7

Distribute the alert message

Proceed as follows to distribute the default alert message:

- Select the zones.
- Start the alert message.

Select zones

Select the zones to which the default alert message must be distributed with the Zone select buttons on the front of the voice alarm controller or the remote controls. A red LED indicates the zones to which the default alert message is distributed.

- If the indicator of a Zone select button is off, the zone is not selected. Push the button to select the zone.
- If the indicator of a Zone select button is on, the zone is selected. Push the button to deselect the zone.



Notice!

If no additional action is taken within 10 seconds after the last Zone select button has been pushed (for example pushing the Alert message button), the zone selection is cancelled.

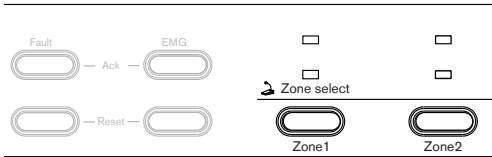

Figure 7.15: Zone select buttons

To select all zones, push the All call button on the front panel of the voice alarm controller or the remote controls.

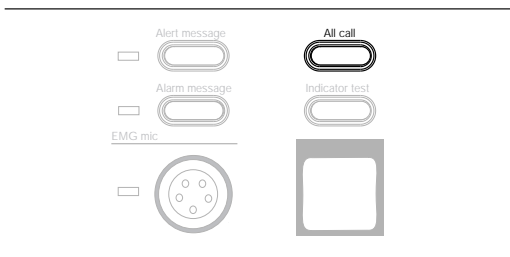

Figure 7.16: All call button

Start the alert message

Push the Alert message button on the front of the voice alarm controller or the remote controls to distribute the default alert message. The message is only distributed to the selected zones.

- If the red Alert message indicator is off, the alert message is not distributed. Push the Alert message button to distribute the default alert message.
- If the red Alert message indicator is on, the message is distributed. Push the Alert message button to stop distributing the default alert message.

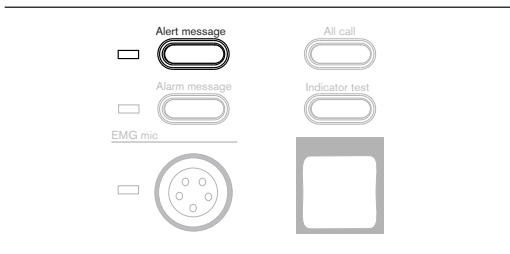

Figure 7.17: Alert message button

7.4.8 Distribute the alarm message

Distributing the default alarm message is similar to distributing the default alert message (see section *Distribute the alert message, page 94*). Push the Alarm message button instead of the Alert message button. The alarm message can also be distributed by pushing the Alarm Message button on the fireman's panel.

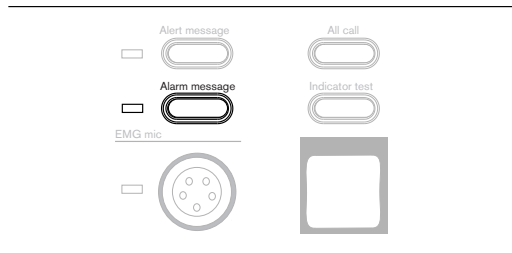

Figure 7.18: Alarm message button

7.5 Fault State

If a supervised function fails, the system enters the fault state and:

- Starts a beeper. The beeper is switched off when the fault is acknowledged (see section *Acknowledge the fault state, page 96*).
- Closes the Fault Status NO output contacts. This status output contact is opened again when the fault is reset (see section *Reset the fault state, page 97*).
- Lights a fault indicator on the front panels that indicates the source of the fault (see *Fault indicators, page 98*). The indicator is switched off when the fault is reset (see section *Reset the fault state, page 97*).

7.5.1 Acknowledge the fault state

The beeper can be switched off by acknowledging the fault state with the Fault Ack button on the front of the voice alarm controller or the remote controls. The fault state can also be acknowledged by pushing the Fault Acknowledge button on the fireman's panel.

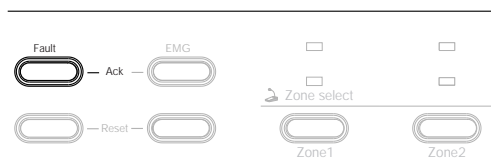

Figure 7.19: Fault Ack button

The following buttons also acknowledge the fault state and stop the beeper:

- Alert message button.
- Alarm message button.
- PTT button of the emergency microphone.

7.5.2 Reset the fault state

Reset the fault state by pushing the Fault Reset button on the front of the voice alarm controller or the remote controls. The fault state can also be reset by pushing the Fault Reset button on the fireman’s panel. In order to reset the fault state, it first must be acknowledged (see section *Acknowledge the fault state*, page 96).

When the Fault Reset button is pushed, the fault indicators are switched off and the status of the system is checked.

- If the fault is not resolved, the fault indicators are switched on again. The beeper remains off. It is only switched on if a new fault occurs or if the resolved fault occurs again.
- If the fault is resolved, the fault indicators remain off.

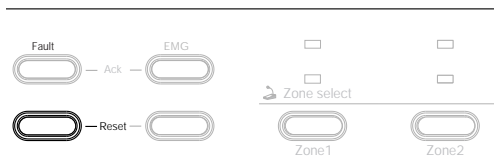

Figure 7.20: Fault reset button

7.5.3

Fault indicators

The voice alarm controller, voice alarm router and remote controls have two types of fault indicators: System fault indicators and loudspeaker line fault indicators (see *Supervision, page 78*). The system fault indicators provide information about failing system functions that are supervised. If a system fault is persistent, contact your Bosch representative.

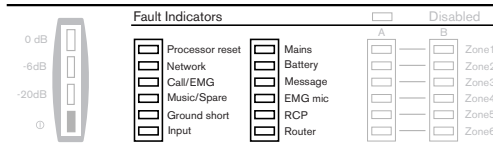

Figure 7.21: System fault indicators

The loudspeaker line indicators provide information about failing loudspeaker lines. They indicate short-circuit and impedance supervision faults (see section *Line supervision, page 80*). If a loudspeaker line indicator lights, check the wiring of the indicated loudspeaker line and try to solve the fault. If it not possible to determine the fault, contact your Bosch representative.

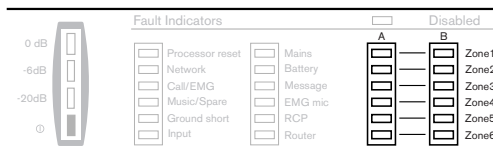

Figure 7.22: Loudspeaker line indicators

If supervision is disabled (see section *Supervision, page 78*), the fault indicators do not function and the Disabled indicator is lit:

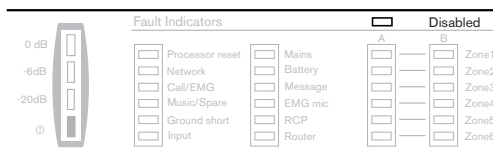

Figure 7.23: Disabled indicator

The availability of the indicators can be tested with the Indicator test button:

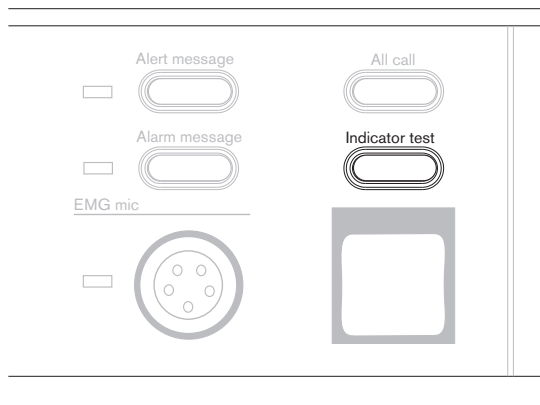

Figure 7.24: Indicator test button

Indicator	Description	Recommended action	Additional information
Processor reset	A processor reset is detected.	Switch the voice alarm controller off and on again.	See section <i>Processor reset</i> , page 79.
Network	A network fault is detected.	Check all network connections and the network configuration.	See section <i>Call station</i> , page 50 and section <i>Voice alarm router</i> , page 82, section <i>Voice alarm routers</i> , page 51 and section <i>Call station</i> , page 83.
Call/EMG	The call power amplifier failed.	In 1-channel mode: Switch the voice alarm controller off and on again. In 2-channel mode: Switch the external power amplifiers off and on again.	See section <i>External power amplifier</i> , page 52, section <i>External power amplifiers</i> , page 67 and section <i>1-Channel mode operation</i> , page 77 and section <i>2-Channel mode operation</i> , page 78.
Music/Spare	The BGM power amplifier failed.	In 1-channel mode: Switch the external power amplifiers off and on again. In 2-channel mode: Switch the voice alarm controller off and on again.	See section <i>External power amplifier</i> , page 52, section <i>External power amplifiers</i> , page 67 and section <i>1-Channel mode operation</i> , page 77 and section <i>2-Channel mode operation</i> , page 78.
Ground short	A short-to-ground fault in the loudspeaker line cabling is detected.	Check all loudspeaker lines for short-to-ground situations.	See section <i>Loudspeakers</i> , page 54 and section <i>Line supervision</i> , page 80.
Input	fault in the connection to an emergency trigger input is detected.	Check the connections to all supervised emergency trigger inputs.	See section <i>Voice Alarm Controller</i> , page 106 and section <i>Emergency trigger inputs</i> , page 80.
Mains	A mains power failure is detected.	Check the mains power connection of the voice alarm controller and the mains power availability.	See section <i>Power</i> , page 62 and section <i>Mains power</i> , page 80.
Battery	A back-up power failure is detected.	Check the back-up power supply connection of the voice alarm controller and the back-up power availability.	See section <i>Power</i> , page 62 and section <i>Battery</i> , page 80.

Indicator	Description	Recommended action	Additional information
Message	A message fault is detected.	Switch the voice alarm controller off and on again.	See section <i>Message supervision, page 80</i> .
EMG mic	An emergency microphone fault is detected.	Check the emergency microphone. If necessary, replace it.	See section <i>Emergency microphone, page 49</i> and section <i>Emergency microphone, page 80</i> .
RCP	A remote control panel fault is detected.	Contact your dealer.	This fault should not occur, since this type of supervision is disabled.
Router	A router fault is detected.	The indicated fault was not detected in the voice alarm controller, but in a voice alarm router.	Check the voice alarm routers.

Table 7.2: System fault indicators

8 Troubleshooting

8.1 Introduction

Although the Plena Voice Alarm System is simple and easy in general, still questions may arise. Maybe because of inexperience or maybe because of exploring limits of what the Plena Voice Alarm System can do. In practice often the same questions reoccur. In other cases questions can be foreseen. An attempt was made to put all these questions on paper, so there is no need to ask them anymore. The answers are here already and the questions are listed by symptom. If necessary, refer to *Fault indicators*, page 98 for information on the system fault indicators.

8.2 Message or chime does not sound

First check if all messages (and wave files) were downloaded using the option *Upload messages and configuration*. You should do this when ANY message or wave file is changed. If this is omitted even messages that are unchanged may stop working.

Some wave files are known to contain a proprietary block of data which cannot be interpreted by the Plena Voice Alarm System Controller. This block of data is called a PAD chunk. This PAD chunk can easily be removed by first loading the wave file into Audacity and then saving it again without modifying. Audacity will save it without the PAD chunk. Audacity is a free software tool that could be downloaded from the Plena Voice Alarm System product related information on www.boschsecurity.com.

8.3 No pilot tone detected on EOL board

The EOL board only works on a 2-channel system. Pilot-tone detection will also fail in a Controller zone when BGM is selected and BGM is attenuated more than -9 dB with the rotary volume control. Also when a call is going on the pilot-tone will be absent on zones without call and BGM. Fault detection on the Plena Voice Alarm System will ignore this if properly configured.

8.4 No pilot tone detected on power amplifier

This may happen when the 100 V slave input is used and the 0 V and 100 V connections are swapped.

Another possibility is when the 100 V slave input is used and no Call or BGM is present on the 100 V input (from the 100 V A or B line). When you want to use pilot tone supervision be sure to use 2-channel mode and define the fault trigger input as EOL supervision input.

8.5 No BGM on the router

Please be aware that the 70 V terminal of the Booster 1 input should be connected to the 70 V output of the Power Amplifier. If this is omitted there will not be BGM on the zones of the router.

8.6 No BGM on controller or router

This can happen when there is an amplifier failure, for instance in a 1-channel system without using a spare amplifier. If supervision of the spare amplifier is nevertheless enabled a fault is detected and BGM will be disabled. Check for the amplifier fault and rectify the problem, for instance by correcting the configuration or replacing the defective unit.

8.7 No sound coming from the router

Please check, if you are using a Plena Power Amplifier 720/480W, if the Line signal is connected to the Program Input. If the line signal is connected to the Priority Input instead of the Program Input there will be no output signal on the amplifier's loudspeaker output.

8.8 Volume override only working for EMG, not for business calls (or similar problems)

Confusion can arise in 2-channel operation. In contradiction to what one would expect volume override will be active in zones without BGM when no call is active. This is sometimes wrongly interpreted mixing up fail-safe override and power saving override.

8.9 False Ground Short fault

Please check if the 0 V and 100 V connections are swapped. Swapping these could cause a false ground short fault appearing and disappearing at unpredictable moments and events.

8.10 Start/Stop function on Trigger Inputs

This is a functionality which is not really intended at the moment, but may be desired by the user. Program a message which consists of a silent wave file, with the maximum repeat of 255. Name it Stop.

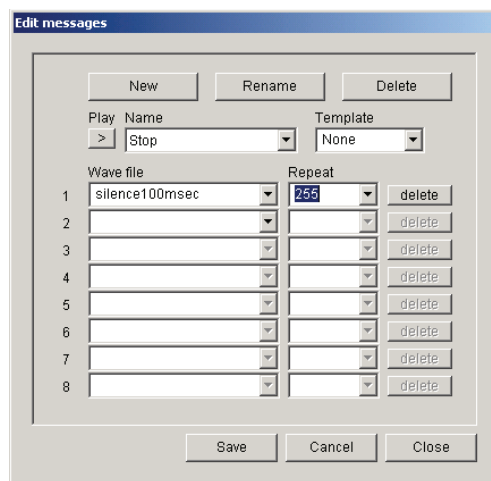

Figure 8.1: Silent wave file message

Since the Start action on the trigger input needs to be latched the Trigger Type under Action Programming > Controller > EMG Trigger/Fault Detector should be set to Toggle. Configure the alarm message for the Trigger Input which you want to be used for the Start function. Configure the silent message named Stop for the Trigger Input you want to use for the Stop function. Select All Zones for its Zone Selection. The priority must be higher than the priority of the Trigger Inputs used for Start.

When the alarm is stopped with the Trigger Input Stop all zones will be silent but the system will still be in Emergency State. The end user then needs to press Emergency Acknowledge and Emergency Reset to terminate this Emergency State.

8.11 Processor Reset

This fault can occur when the Service DIP Switches are left in the wrong position. This frequently occurs when people have downloaded new firmware. The correct positions should be SEL0 and SEL1 to on, and Enable Firmware Download to off.

The fault indication for Processor Reset cannot be disabled, neither in the configuration nor with the dipswitch Supervision at the back of the Controller.

8.12 USB port not connected

This error message can occur when the Configuration Software is just installed. Although there is no such instruction displayed during installation it is recommended that your PC is rebooted after installing the Configuration Software.

This problem could also occur when the Service DIP Switches are in the wrong position. A more common problem in such a case is a Processor Reset Fault. However if fault supervision is disabled this fault indication will not occur and *USB port not connected* could occur. Please refer to the section Processor Reset for more information.

8.13 Data fault during configuration upload

This fault occurs when the Configuration Software you are using and the Firmware on the Controller to which you are uploading have a different incompatible version.

8.14 A click sounds through the loudspeakers at regular intervals

In a very silent environment like meeting rooms and offices, especially when they are abandoned, a small click can be heard at the start and end of an impedance measurement. This click is simply caused by the 20 kHz pilot tone being switched on and off. The level of the click is small, but also depends on cable parameters, loudspeaker characteristics and load. If the click, no matter how weak it is, is unacceptable then end of line supervision using the EOL board should be considered instead of impedance supervision.

8.15 Password not working

A fault message, like indicated below, occurs when data used by the Configuration Software is corrupted. It sometime happens after a software upgrade or when different versions of the Configuration Software have been installed on your PC.

To fix it uninstall all versions of Configuration Software and (only) reinstall the version you will use.

8.16 Configuration download fails

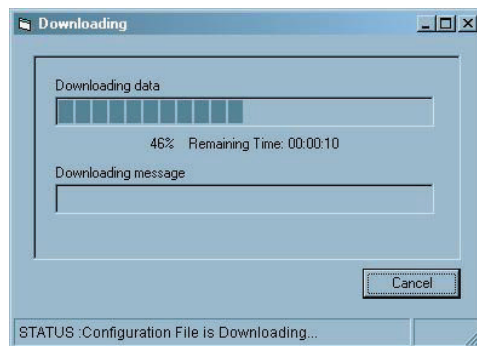

Figure 8.2: Downloading window

When the configuration download fails and the message in the window above changes to *STATUS: Downloading data failed* there is a wave file in the configuration with misinterpreted data. The file might be created with Audacity. Files created with R8brain do not suffer from this.

8.17 Can't retrieve the original wave files with the configuration download

Please note that the names of wave files, messages, message templates, zones and zone groups are not stored in the Controller and therefore cannot be retrieved. However all data is still there in the right place leaving a correctly functioning configuration. The names taken are default names followed by an incremental number. The default names are listed below:

Label or file type	Default name
Wave file	Wave#.wav
Message name	Message #
Template name	Template #
Controller Zone	Controller Output Z#
Router Zone	Router # Output Z#
Zone Group	Group #

Table 8.1: Default file names

The wave files will be stored in the folder *C:\Program Files\Bosch\Plena Voice Alarm System\Configuration\Sounds\Backup*, or *C:\Program Files (86)\.....*, or *C:\Bosch\Plena....*

9 Maintenance

The system requires minimum maintenance.

To keep the system in good condition, do the following:

- Clean the units (section *Clean the units*, page 105)
- Clean the air inlets (section *Clean air inlets*, page 105)
- Check connectors and grounding (section *Check the connectors and grounding*, page 105).



Warning!

Dangerous mains voltages are present inside the units. Disconnect the main power supply before you do any maintenance.

9.1 Clean the units

Periodically you must clean all units with a damp, lint-free cloth.

9.2 Clean air inlets

The 19-inch units can collect dust as a result of the internal fans. Once a year you should use a vacuum cleaner to clean the air inlets of all units in the 19-inch racks.

9.3 Check the connectors and grounding

Periodically check:

- All cable connections.
- The ground (PE) connection of the system components.

10 Technical data

10.1 Electrical

10.1.1 Voice Alarm Controller

Electrical

Mains voltage:	230/115 V(AC), \pm 10%, 50/60 Hz
Mains current:	0.3 A (system idle)
	4.0 A (maximum load)
Max. mains inrush current:	6.3 A (for mains voltage of 220 - 240 V)
	10 A (for mains voltage of 100 - 120 V)
Battery voltage:	20.0 to 26.5 V(DC)
Battery current:	0.9 A (system idle)
	14 A (maximum load)



Notice!

Maximum load means maximum power out, maximum load 24 V(DC) out and maximum number of call stations.

Message manager

Data format:	WAV-file, 16-bit PCM, mono
Supported sample rates (fs):	24 kHz, 22.05 kHz, 16 kHz, 12 kHz, 11.025 kHz
Frequency response:	@ fs = 24 kHz, 100 Hz - 11 kHz (+1/-3 dB)
	@ fs = 22.05 kHz, 100 Hz - 10 kHz (+1/-3 dB)
	@ fs = 16 kHz, 100 Hz - 7.3 kHz (+1/- 3 dB)
	@ fs = 12 kHz, 100 Hz - 5.5 kHz (+1/-3 dB)
	@ fs = 11.025 kHz, 100 Hz - 5 kHz (+1/-3 dB)
Distortion:	< 0.1% @ 1 kHz
Signal-to-noise ratio (flat at max. volume):	> 80 dB
Memory capacity:	64 Mbit Flash
Recording/playback time:	333 s @ fs = 24 kHz
Number of messages:	max. 254 wave files
Supervision EEPROM:	Continuous checksum control
Supervision DAC:	1 Hz pilot tone
Data retention time:	> 10 years

Internal power amplifier

Rated output power:	240 W
Frequency response:	100 Hz - 18 kHz (+1/-3 dB, @ -10 dB ref. rated output)
Distortion:	< 1% @ rated output power, 1 kHz
Signal-to-noise ratio (flat at max. volume):	> 85 dB
Supervision:	20 kHz pilot tone
Outputs:	70, 100 V screw terminal, 100 V call out

Interconnection

Call Station:	RJ45 sockets, CAN bus; max. 8 call stations
Voice Alarm Router:	RJ45 socket, CAN bus; max. 9 routers
Remote controls (Fireman's Panel, Remote Control, Remote Control Extension):	RJ45 socket, CAN bus; max. 2 remote controls
PC:	USB 2.0 (USB 1.1 compatible)
External power amplifier:	3-pin XLR and screw terminals, max. 5 A; max. rated output 1000 W

Loudspeaker outputs

Type:	Screw terminals
Number of zones:	6
Number of loudspeaker lines:	12 (2 per zone)
Signal-to-noise ratio (flat at max. volume):	> 85 dB
Line voltage:	100 V

Overrides

Type:	3-wire or 4-wire on screw terminals
Voltage:	24 V(DC) for 4-wire, if selected
Current:	total 0.8 A

Trigger outputs

Type:	Screw terminals
Voltage:	Floating, max. 250 V
Current:	max. 0.5 A

Trigger inputs / 24 V DC out

Trigger voltage:	< 24 V
Type:	Momentary or latching Normally opened (default) or normally closed
Emergency input supervision:	10 k Ω + 10 k Ω series and parallel resistors
24 V DC out:	24 V(DC), max. 0.8 A
VOX switch:	Normally opened

Mic/line input with VOX functionality

Type:	3-pin XLR, 6.3 mm jack socket, balanced
Sensitivity:	1 mV +1/-3 dB (mic), 1 V +1/-3 dB (line)
Impedance:	> 10 k Ω
VOX threshold:	-10 dB ref nominal input level

BGM

Type:	Cinch, stereo converted to mono
Nominal input level:	500 mV

Line out

Type:	3-pin XLR, 6.3 mm jack socket, balanced
Nominal output level:	1 V
Maximum output level:	1 V

External power amplifier

Type:	3-pin XLR and screw terminals
Controller output/Amplifier input:	1 V
Controller input/Amplifier output:	100 V

10.1.2 Voice Alarm Router

Electrical

Mains voltage:	230/115 V(AC), $\pm 10\%$, 50/60 Hz
Mains current:	0.2 A (system idle)
	0.3 A (maximum load)
Max. mains inrush current:	1.5 A (for mains voltage of 220 - 240 V)
	3 A (for mains voltage of 100 - 120 V)
Battery voltage:	20.0 to 26.5 V(DC)
Battery current:	0.5 A (system idle)
	1.5 A (maximum load)



Notice!

Maximum load means maximum power out, maximum load 24 V(DC) out and maximum number of call stations.

Interconnection

Voice Alarm Router:	RJ45 socket, CAN bus; max. 2 routers
External power amplifiers:	3-pin XLR and screw terminals, max. 5 A; max. rated output 1000 W

Loudspeaker outputs

Type:	Screw terminals
Number of zones:	6
Number of loudspeaker lines:	12 (2 per zone)
Signal-to-noise ratio (flat at max. volume):	> 85 dB
Line voltage:	100 V

Overrides

Type:	3-wire or 4-wire on screw terminals
Voltage:	24 V(DC) for 4-wire, if selected
Current:	Total 0.8 A

Trigger inputs / 24 V DC out

Trigger voltage:	< 24 V
Type:	Momentary or latching
	Normally opened (default) or normally closed
Emergency input supervision:	10 k Ω + 10 k Ω series and parallel resistors
24 V DC out:	24 V(DC), max. 0.8 A

External power amplifiers

Type:	3-pin XLR and screw terminals
Router output/Amplifier input:	1 V
Router input/Amplifier output:	100 V

10.1.3**Call Station****Electrical**

Voltage range:	24 V(DC), +20%/-10%, supplied by the Controller or external power source
Current consumption:	< 30 mA

Performance

Nominal sensitivity:	85 dB SPL (gain preset 0 dB)
Nominal output level:	355 mV
Maximum input sound level:	110 dB SPL
Gain preset:	+6/0/-15 dB
Limiter threshold:	2 V
Compression ratio limiter:	20:1
Distortion:	< 0.6% (nominal input) < 5% (maximum input)
Equivalent input noise level:	25 dB SPL(A)
Frequency response:	100 Hz - 16 kHz
Speech filter:	- 3 dB @ 500 Hz, high-pass, 6 dB/oct
Output impedance:	200 Ω

Interconnection

Type:	2x redundant RJ45 sockets to connect the call station to the voice alarm system controller with CAT-5 Ethernet cables.
-------	--

10.2**Physical characteristics****10.2.1****Voice Alarm Controller**

Dimensions:	19" wide, 3 U high, 360 mm deep (leave 50 mm for connections)
19" mounting brackets:	Included
Weight:	Approx. 20 kg

10.2.2 Voice Alarm Router

Dimensions:	19" wide, 2 U high, 250 mm deep (leave 50 mm for connections)
19" mounting brackets:	Included
Weight:	Approx. 3 kg

10.2.3 Call Station

Dimensions:	40 x 100 x 235 (base) 390 mm stem length (with microphone)
Weight:	Approx. 1 kg

10.2.4 Call Station Keypad

Dimensions:	40 x 100 x 235 (base)
-------------	-----------------------

10.2.5 Voice Alarm Remote Control

Current consumption:	150 mA (typical), 24 V(DC)
	400 mA (indicator test), 24 V(DC)
Dimensions:	132.5 x 430 x 90 mm
Weight:	2.2 kg

10.2.6 Voice Alarm Remote Control Kit

Current consumption:	150 mA (idle)
	400 mA (indicator test)
Dimensions:	132.5 x 430 x 90 mm
Weight:	2.2 kg

10.2.7 Remote Control Extension

Current consumption:	50 mA (idle)
	200 mA (indicator test)
Dimensions:	88 x 432 x 90 mm
Weight:	1.8 kg

10.2.8 Remote Control Extension Kit

Current consumption:	50 mA (idle)
	200 mA (indicator test)
Dimensions:	88 x 432 x 90 mm
Weight:	1.8 kg

10.2.9 Fireman's Panel

Current consumption:	150 mA (idle)
	400 mA (indicator test)
Dimensions:	132.5 x 430 x 90 mm
Weight:	2.2 kg

10.2.10 End of line detection board

Input level:	100 V rms @ program 20 Hz - 20 kHz
Pilot input level:	5 V - 50 V @ 20 kHz \pm 20%
Minimum trigger level:	3.5 V
Output:	Floating single trigger
Isolation:	250 Vp
Max level on open contact:	250 VDC
Response time:	Close min. 1 second
	Close max. 10 seconds

10.3 Environmental conditions**10.3.1 Voice Alarm Controller**

Operating temperature range:	-10 to +55 °C
Storage temperature range:	-40 to +70 °C
Relative humidity:	< 95%

10.3.2 Voice Alarm Router

Operating temperature range:	-10 to +55 °C
Storage temperature range:	-25 to +55 °C
Relative humidity:	< 95%

10.3.3 Call Station

Operating temperature range:	-10 to +55 °C
Storage temperature range:	-40 to +70 °C
Relative humidity:	< 95%

10.4 Standards

10.4.1 Voice Alarm Controller

EMC emission:	According to EN55103-1
EMC immunity:	According to EN55103-2

11 Appendices

11.1 Compliancy checklists

11.1.1 Emergency Sound Systems

Bosch Security Systems B.V. has made a great effort for the design and manufacturing of the components and also supplies all documentation that enables the assembly of a safe and high quality emergency unit in accordance with EN60849:1998, EN54-16:2008 and ISO7240-16:2007. Bosch Security Systems B.V. has made up this list of requirements, based on the standard, which needs to be filled in and subsequently signed off by both parties. The signed paper has the nature of a certificate and can have significant meaning in the case of a legal investigation of the liability issue for personal injuries.

- The safety of the system in accordance with EN60849:1998, EN54-16:2008 and ISO7240-16:2007 in an alarm and emergency application does not only depend on component safety, but also highly on the installation engineer and the operator. For example, the sound pressure level of the system depends on the installation. Moreover, the system should only be installed and operated by qualified personnel.
- Modifications of the system should only be executed by authorized persons in accordance with the safety concept and need to be registered in the system documentation.
- If third party components (not delivered by Bosch Security Systems B.V.) are added to the minimal configuration of Plena Voice Alarm System, then the EN60849:1998, EN54-16:2008 and ISO7240-16:2007 certification becomes expired. This does not apply to BGM sources or non evac features.
- Only use a UPS compliant to the current standards and legislation in combination with the Plena Voice Alarm System.
- The end-user must maintain a journal for the system.
- The installer is responsible for security measures to prevent improper use of the system.
- Bosch Security Systems B.V. refuses any liability for damage that might result from non-observance of these instructions.

Herewith the undersigned states that he/she has processed for him/her applicable requirements, as specified in this document, in an adequate way and has confirmed this fact by signing the rightmost column of each applicable requirement.

	Installer	End-user
Name:		
Signature:		
Date:		
Place:		

11.1.2**EN60849: 1998**

Valid for version 2.13.xx

4. General system requirements

Clause / Requirement	Compliance	Signature
4.1 Principal features		
A sound system for emergency purposes shall permit the broadcasting of intelligible information of measures to be taken for the protection of lives within one or more specified areas.	Compliant, if properly installed. The relevant article is covered by the Plena Voice Alarm System , The correct installation and configuration is the responsibility of the installer.	
The following criteria shall be fulfilled:		
a When any alarm is detected, the system shall immediately disable any functions not connected with its emergency role (such as paging, music or general pre-recorded announcements being broadcast to the loudspeaker zones requiring emergency broadcasts).	Compliant. The EMG state can be entered in two ways: – When an emergency message is started via the EMG triggers. – The EMG button on the front panel, the remote control or the Fireman's panel is pressed. When the EMG state is entered, all non emergency paging and BGM is stopped.	

Clause / Requirement	Compliance	Signature
<p>b Unless damaged as a result of the emergency, the system shall be available for operation at all times (or as required by the system specification).</p>	<p>Compliant, if all requirements below are fulfilled and installed with:</p> <ul style="list-style-type: none"> – Spare Power Amplifiers. – Multiple loudspeaker circuits per zone or multiple zones. – Battery back-up / UPS back-up. <p>Responsibility of the installer.</p> <ul style="list-style-type: none"> – The communication bus between Controller and Routers and between Controller and Remote Controls is not redundant. If damage or removed, communication between these elements is not possible. Also, when the processor is damaged or fails the system will not function properly. In that event the fault will be clearly indicated on the Controller, Routers (if installed) and Remote Controls (if Installed) Also an audible signal is generated at the Controller and Remote Control. The installer must ensure that during downtime for repair or maintenance the safety of the occupants is ensured. Responsibility of the installer to verify that proper procedures are in place. If the processor is defective, no calls can be made. If the communication bus between routers, or between controller and remote control is broken, no call can be made beyond the point of the broken connection. 	
<p>c The system shall be capable of broadcasting within 10 s after primary or secondary power is applied.</p>	<p>Compliant. It is recommended that the Remote Control at the fireman's entrance is programmed to have the highest priority.</p>	

Clause / Requirement	Compliance	Signature
<p>d Except during the condition described in 4.1c), the system shall be capable of broadcasting a first attention-drawing signal within 3 s of being placed in an emergency mode by the operator, or automatically on receipt of a signal from a fire or other detection system. In the latter case, the period of 3 s includes the reaction time of the detection system from the time the emergency is first detected, to commanding the alarm broadcast.</p>	<p>Compliant. The installer is required to ensure that the Fire detection system does not have latency beyond 2s to ensure that the entire installation reacts within 3s. Note: Reaction time of the Voice Alarm System reacts within 1 second.</p>	
<p>e The system shall be able to broadcast attention-drawing signals and speech messages to one or more areas simultaneously. There shall be at least one appropriate attention-drawing signal alternating with one or more speech messages for this purpose.</p>	<p>Compliant, if attention-drawing signal is part of the configuration. Responsibility of the installer. Note: It is recommended that an attention drawing signal is assigned to the EMG button.</p>	
<p>f At any time the system operator shall be able to receive, by means of a monitoring system, indications of the correct functioning or otherwise of the relevant parts of the emergency system (see also 5.2 and 5.3).</p>	<p>Compliant.</p>	
<p>g Failure of a single amplifier or loudspeaker circuit shall not result in total loss of coverage in the loudspeaker zone served. NOTE 1 - The monitoring system specified in 4.1f) should indicate the failure of an amplifier or of a loudspeaker circuit. NOTE 2 - Particularly in small buildings, it may not be necessary to install two separate loudspeaker circuits in one loudspeaker zone. A decision on this matter may be subject to local regulations.</p>	<p>Compliant if installed with:</p> <ul style="list-style-type: none"> - Spare Power Amplifiers. - Multiple loudspeaker circuits per zone or multiple zones. A-B wiring. - Appropriate supervision on. <p>Responsibility of the installer.</p>	

Clause / Requirement		Compliance	Signature
h	An attention-drawing signal shall precede the first message for 4 s to 10 s. Successive signals and messages shall then continue until either changed in accordance with the evacuation procedure, or manually silenced. The interval between successive messages shall not exceed 30 s and attention-drawing signals shall be broadcast whenever periods of silence might otherwise exceed 10 s. Where more than one attention-drawing signal is used, such as those used for different types of emergency, each signal shall be clearly distinguishable in character.	Compliant, if attention-drawing signal is part of the pre-recorded message and the configuration has been setup to include this signal. Responsibility of the installer. Note: if you deviate from this, the system is no longer a certified system.	
i	All messages shall be clear, short, unambiguous and as far as practicable, pre-planned.	Responsibility of the installer. Default configuration is compliant. Various messages are pre installed as examples.	
	Where pre-recorded messages are used they shall be held in a non-volatile form, preferably in a solid-state store, and be continuously monitored for availability.	Flash memory is monitored with checksum.	
	The system design shall make it inherently impossible for an external source to corrupt or derange the store or its contents.	Compliant. Upload of a new configuration via external PC is password protected. Other external connections are not available.	
	NOTE - On grounds of reliability, it is preferable not to use storage media depending on mechanical devices.	Storage medium is flash memory.	
j	The language(s) used shall be specified by the purchaser.	Responsibility of the installer.	
k	The system shall be capable of being divided into emergency loudspeaker zones if required by the evacuation procedure. Such zones need not be the same as other zones, for example emergency detection zones or non-emergency loudspeaker zones.	Compliant, if properly installed. Responsibility of the installer.	
l	In determining loudspeaker zones, the following criteria shall apply:		

Clause / Requirement		Compliance	Signature
1	the intelligibility of messages broadcast in one zone shall not be reduced below the requirement of 5.1 by the broadcasting of messages in other zones or from more than one source.	Compliant, if properly installed. Responsibility of the installer.	
2	no emergency detection zone shall contain more than one emergency loudspeaker zone. For non-emergency use, a loudspeaker zone may be subdivided.	Compliant, if properly installed. Responsibility of the installer.	
m	A secondary power source shall be available (see 5.6).	Compliant, if properly installed. Responsibility of the installer. The system has 24V backup power connection.	
4.2 Responsible person			
The person or body, having control of the premises shall nominate a "responsible person", identified by name or job title, who shall be responsible for ensuring that the system is properly maintained and repaired so as to continue to operate as specified.		Responsibility of the person or body having control of the premises. Action to be taken care of by the installer.	
4.3 Priorities			
4.3.1 Classification of priorities			
It is necessary to decide upon an order of priority for the message distribution based upon:			
a	Any automatic programmed response.	Compliant, if properly installed. Responsibility of the installer. The Voice Alarm System has a priority structure.	
b	The perceived risk to occupants, which may require manual override of the programmed response.	Compliant, if properly installed. Responsibility of the installer. EMG microphone always has priority over automated messages.	
Events shall be given a level of priority according to their urgency. The following primary levels are recommended but there may be advantages in adding further subgroups, depending on the operational strategies of the site:		Compliant, if properly installed. Responsibility of the installer.	

Clause / Requirement		Compliance	Signature
a	Evacuate - potentially life-threatening situation needing immediate evacuation.	Compliant, if properly installed. Responsibility of the installer.	
b	Alert - dangerous situation nearby requiring warning of pending evacuation.	Compliant, if properly installed. Responsibility of the installer.	
c	Non-emergency - operational messages, e.g. system test, etc.	Compliant, if properly installed. Responsibility of the installer.	
The use of these levels in descending order of priority will ensure that appropriate alarm signals and messages are provided first to the zones immediately at risk.		Compliant, if properly installed. Responsibility of the installer.	
4.3.2 Operational priorities			
If the voice alarm system is capable of operation in fully automatic mode, a facility shall always be available to control:			
a	The type of pre-recorded message being broadcast.	Compliant, if properly installed: <ul style="list-style-type: none"> - Input contact configured to start a call with a pre-recorded message. - Running message can be overridden by higher priority automatic started messages. - Running message can be overridden by higher priority manually started messages. - Running message can always be overridden by the emergency microphone. 	
b	The distribution of messages to different zones.	Compliant.	
c	Real-time instructions or information to occupants via the emergency microphone (if any).	Compliant, if properly installed. Manual selection of loudspeaker zones is supported.	

Clause / Requirement	Compliance	Signature
Means shall be provided for manual intervention to override any automatically programmed functions. This shall apply both to the nature of the message being broadcast and to the distribution paths of the message. Thus, manual controls shall be provided at the central control point (and also at specified remote control points) to allow:		
a Starting or stopping of pre-recorded alarm messages.	Compliant, if properly installed. Running message can be overridden by higher priority manually started messages. Alarm and Alert messages can be stopped and started from the controller front panel.	
b Selection of appropriate pre-recorded alarm messages.	Compliant, if properly installed. Manual selection of pre-recorded alarm messages is supported.	
c Switching on or off, of selected loudspeaker zones.	Compliant, if properly installed. Manual selection of loudspeaker zones is supported. Adding or removing zones from a running call is supported.	
d Broadcasting of live messages via the emergency microphone (if any). NOTE - The above controls may form part of an emergency detection control panel.	Compliant, if properly installed. Live calls from an emergency call station are supported.	
The emergency control microphone shall have the highest level of priority for access to the voice alarm system, with provision to allow it to override all other broadcasts.	Compliant.	
4.4 Safety requirements		
The safety requirements applying to emergency sound systems are given in IEC60065 or other appropriate IEC safety standards.	Compliant. The Plena Voice Alarm System complies with IEC60065.	

Clause / Requirement	Compliance	Signature
The mechanical construction of the system shall be such that under the influence of internally generated heat, explosion or implosion, however caused, no part shall cause injury to any person.	Compliant.	
Where any part of the system is installed in areas with hazardous or explosive atmospheres, the relevant safety requirements of IEC60079 shall be met.	Responsibility of the installer. The Plena Voice Alarm System equipment itself does not comply with IEC60079.	

5. System technical requirements

Clause / Requirement	Compliance	Signature
5.1 Speech intelligibility		
Unless otherwise specified, the following requirement shall be satisfied:		
The speech intelligibility over all of an area of coverage shall be greater than or equal to 0,7 on the common intelligibility scale (CIS). See annexes A and B for the conversion between CIS and other scales of intelligibility. The noise level (see B.5) at the time of measurement (but in the absence of the test signal) and the test signal level shall be stated with the test result. NOTE - If the persons who are required to understand the messages are, or will be, reasonably familiar with them through regular system tests, the effective intelligibility tends to increase by approximately 0,05 on the CIS if the intelligibility is in the range 0,6 to 0,7. This may apply, for example, in an office building. However, in a sports ground, for example, most of the messages are likely to be relatively unfamiliar to the majority of persons present, and no relaxation of the above requirement should be considered.	Responsibility of the installer.	
The system specification may exclude from the area of coverage, defined areas rarely or never occupied by people.	Responsibility of the installer.	
5.2 Automatic status indication		
A clear indication shall automatically be given at the designated control locations of:		

Clause / Requirement		Compliance	Signature
a	System availability.	Compliant. Indication on controller, router and call station.	
b	Power supply availability.	Compliant. Indication on controller, router and call station.	
c	Any fault condition.	Compliant. Indication on controller, router and call station.	
d	For systems having numerous loudspeaker zones, which loudspeaker zones are selected and the mode of operation of each zone, i.e. "evacuate" or "alert" and pre-selection of emergency microphone. Where different alarm messages are provided, which are dependent on the evacuation requirements, indication of which message is being broadcast and into which zone, shall be displayed by a suitable method. This information shall be continuously displayed and kept up to date.	Compliant. Indication on controller, router. The Plena Voice Alarm System Remote Control is part of the certified system. If the Fireman's Panel is used, there should only be one emergency zone, covering all zones of the system. The Fireman's Panel is an all call remote control with large buttons..	
5.3 Automatic fault monitoring			
A clear indication shall automatically be given, at specified locations, e.g. at main equipment locations, of:			
a	Short-circuit or disconnection or failure of the primary power source.	Compliant, if properly installed. Responsibility of the installer. Backup via 24 V.	
b	Short-circuit or disconnection or failure of the standby power source.	Compliant, if properly installed. Responsibility of the installer. Backup via 24 V.	
c	Short-circuit or disconnection or failure of any battery charging equipment associated with the primary or standby power sources.	Responsibility of the installer. Supervision of third party charging equipment is via control inputs.	
d	Rupture of any fuse or operation of circuit breaker, isolator or protective device that may prevent an emergency broadcast.	Compliant. Fault is indicated on the controller and router. Configuration must be set up to supervise this.	
e	Failure of microphone, including capsule voice coil, pre-amplifier and essential wiring to the rest of the system.	Compliant. Fault is indicated on the controller and router. Configuration must be set up to supervise this.	

Clause / Requirement		Compliance	Signature
f	Failure of critical signal paths through the amplification chain, with individual amplifiers separately identified.	Compliant. Fault is indicated on the controller and router. Configuration must be set up to supervise this.	
g	Amplifiers or critical modules missing.	Compliant. Fault is indicated on the controller and router. Configuration must be set up to supervise this.	
h	Failure of any standby amplifier.	Compliant. Fault is indicated on the controller and router. Configuration must be set up to supervise this.	
i	Failure of emergency signal generators, including emergency pre-recorded message stores.	Compliant. Fault is indicated on the controller and router. Configuration must be set up to supervise this.	
j	Failure of any loudspeaker circuit (open- and short-circuit faults).	Compliant. Fault is indicated on the controller and router. Configuration must be set up to supervise this.	
k	Short-circuit or disconnection of visual alarm devices.	Supervised Trigger inputs must be set up to monitor this, installer.	
l	Failure of a processor to correctly execute its software program.	Compliant. Fault is indicated on the controller and router. Configuration must be set up to supervise this.	
m	Detection of any error during memory checking.	Compliant. Fault is indicated on the controller and router. Configuration must be set up to supervise this.	
n	Cessation of any scanning or interrogation process.	Compliant. Fault is indicated on the controller and router. Configuration must be set up to supervise this.	
o	Failure of the interconnecting data or voice communication links between parts of a distributed system.	Compliant. Fault is indicated on the controller and router. Configuration must be set up to supervise this.	

Clause / Requirement	Compliance	Signature
<p>In addition to individual fault identification at these locations, a common sounder shall sound for a minimum of 0,5 s every 5 s. A fault shall cause the sounder to operate in a latched mode and a visual indicator to light, either steadily, or in a flashing mode. Manual acceptance and reset switching shall be included. When accepted, the sounder shall be silenced and the indicator shall change to (or remain in) steady illumination. The occurrence of a further fault condition shall reactivate the sounder and the visual indicator. When all the faults have been cleared, the indicator shall be switched off, either automatically or by operating a reset switch.</p>	<p>Compliant. Fault identification and sounder is part of the controller.</p>	
<p>The fault indication should be given within 100 s of the occurrence of the fault, regardless of whether the voice alarm system is being used for non-emergency purposes, such as the transmission of background music.</p>	<p>Compliant.</p>	
<p>5.4 Monitoring of software controlled equipment</p>		
<p>The correct execution of the system software by any microprocessor shall be monitored by internal self-checking procedures and by an appropriate monitoring circuit (e.g. "watch dog" circuit) complying with the following:</p>		
<p>a The monitoring circuit and its associated indication and signalling circuits shall not be prevented from determining and signalling a fault condition by the failure of any microprocessor or associated clock circuits.</p>	<p>Compliant.</p>	
<p>b The monitoring circuit shall monitor the execution of routines associated with the main program elements (i.e. it shall not be solely associated with "waiting" or other "housekeeping" routines).</p>	<p>Compliant. Fault is indicated on the controller and router. Configuration must be set up to supervise this.</p>	

Clause / Requirement		Compliance	Signature
c	In the event of a failure by a microprocessor to execute its software correctly, the monitoring circuit shall (in addition to initiating an audible and visual fault warning) perform as follows:	Compliant. Fault is indicated on the controller and router. Configuration must be set up to supervise this.	
1	re-initialize the processor and attempt to restart the program at a suitable point within 10 s of the occurrence of the failure. The re-initialisation procedure shall verify that the contents of memory, both program and data, are not corrupted, and	Compliant, both data and program are checked for the Controller and the firmware in the routers.	
2	either		
	i record that a failure has occurred (using a system capable of recording a minimum of 99 failures and re-settable only by an operation restricted to authorized servicing personnel) or		
	ii automatically reset the equipment and give an audible and visual warning that an automatic reset has occurred.	Compliant. Fault is indicated on the controller and router. This function cannot be switched off.	
5.5 Interface with emergency detection systems			
The communication link between the emergency detection system and the sound system shall be continuously monitored for faults. This is normally performed by the control equipment for the emergency detection system, which gives an audible and visual indication of a fault in the link between the two systems.		Compliant, if properly installed using supervised trigger inputs. Responsibility of the installer.	

Clause / Requirement	Compliance	Signature
<p>The emergency detection system shall also be capable of receiving information regarding faults in the sound system and shall include a provision, usually at its control and indicating equipment, for appropriate audible and visual indication of such faults. As a minimum, the sound system shall be capable of transmitting to the emergency detection system one general "Sound system fault" for any of the fault conditions listed in 5.3 that may occur within the sound system.</p>	<p>Compliant, if properly installed using trigger outputs. Responsibility of the installer.</p>	
<p>The link between a fire detection and alarm system and the voice alarm system is of crucial importance in maintaining the integrity of overall operation. It may be desirable on larger systems, where distributed control equipment is used, to provide a link at each control equipment location rather than to rely on a central location. Each link shall be monitored. The voice alarm system shall be capable of continuing to broadcast alarm messages, which have been initiated by the fire detection and alarm system, even in the event of a subsequent fault in the interconnecting link between the two systems (i.e. the voice alarm system shall "latch" on receipt of a signal from the fire detection and alarm system). Interruption by higher priority broadcasts shall still be possible.</p>	<p>N/a.</p>	
<p>In complex buildings in which actions, such as initiation of evacuation signals, silencing of alarm signals, etc., can be implemented at remote voice alarm equipment, consideration shall be given to whether there is a need for such actions to be indicated at any central fire detection and alarm control and indicating equipment.</p>	<p>Responsibility of the installer.</p>	
<p>5.6 Secondary power supply</p>		

Clause / Requirement	Compliance	Signature
<p>If the building is to be evacuated following primary power failure, a secondary power supply shall be provided. This shall be capable of operating the system in the emergency mode for a period equal to twice the evacuation time determined by the appropriate authority for the building. In any event, the secondary power supply shall be capable of powering the system for a minimum of 30 min.</p>	<p>Power consumption data is available in various Plena equipment data sheets. With this information the necessary back up capacity can be calculated, Responsibility of the installer.</p>	
<p>If the building is not to be evacuated following failure of the principal power supply, the secondary power supply shall be capable of operating the system for at least 24 h, or 6 h if an emergency generator is available, and then powering the system in emergency mode for a minimum of 30 min. If a building remains unoccupied for several days, provision should be made to ensure that the voice alarm system is capable of operation in emergency mode for 30 min. when the building is re-occupied.</p>	<p>See above. Responsibility of the installer.</p>	
<p>Non-emergency functions within the system, such as background music, shall not operate from the secondary power supply if this will reduce the capacity for emergency operation.</p>	<p>Responsibility of the installer by connecting the BGM source to the primary power supply. From release 1.1 onwards the BGM will be deactivated.</p>	
<p>If batteries are used as a secondary power supply they shall be of the secondary type, complete with automatic charging facilities. Where lead-acid batteries are used they shall be of the valve-regulated type unless otherwise specified, and the charging system shall incorporate charging current compensation for changes in the ambient temperature, where this is necessary to achieve the specified battery life.</p>	<p>Responsibility of the installer.</p>	
<p>Batteries shall be used in accordance with the manufacturer's recommendations in order to achieve their specified life, which shall be not less than four years. The end of life shall be taken as the time when deterioration to less than 80% of the rated ampere-hour capacity (at the one-hour rate) has occurred.</p>	<p>Responsibility of the installer.</p>	

Clause / Requirement	Compliance	Signature
Automatic charging shall ensure that the batteries are fully recharged to 80% of their maximum rated capacity from the fully discharged state in a period of not more than 24 h.	Responsibility of the installer.	
Adequate ventilation and protection against corrosion and dangers resulting from gases emitted by the batteries shall be provided.	Responsibility of the installer.	
5.7 Climate and environmental conditions		
As all or part of the system may be installed inside or outside buildings, under various climatic and environmental conditions, and exposed to possible mechanical damage, full information on the conditions under which the system is required to operate shall be included in the system specification. For tests, refer to IEC60068-1 (environmental testing).	The Plena Voice Alarm System specifications exceed the environmental requirements given by IEC60849.	
When not otherwise specified, equipment shall operate in accordance with the system specification under the following conditions:		
a Control and amplification equipment and associated battery power supplies: <ul style="list-style-type: none"> - Ambient temperature -5 °C to + 40 °C. - Relative humidity 25% to 90%. - Air pressure 86 kPa to 106 kPa. 		
b All other equipment: <ul style="list-style-type: none"> - Ambient temperature -20 °C to +55 °C. - Relative humidity 25% to 99%. - Air pressure 86 kPa to 106 kPa. 		
5.8 Marking and symbols for marking		
Equipment shall be permanently marked with information regarding its function.	Compliant.	
Terminals and controls shall be permanently marked with information regarding their function, characteristics and polarity.	Compliant.	

Clause / Requirement	Compliance	Signature
The marking shall be such that it shall be possible to adjust the user controls and to confirm their positions accurately in conformity with the information given in the user instructions.	Compliant.	
Marking shall preferably include letter symbols, signs, numbers and colors that are internationally comprehensible. Reference is required to IEC60027 and IEC60417. Marking not included in these standards shall be clearly explained in the user instructions.	Compliant.	
5.9 Electrical matching values		
For the electrical matching values, reference is required to IEC61938 unless otherwise specified.	Compliant (specified in Technical data sections).	
5.10 Connectors		
Connectors shall comply with IEC60268-11 or IEC60268-12. Requirements for fire resistance of connectors may also be stipulated by the relevant authorities.	Connectors comply to IEC60268-11 or IEC60268-12. Additional requirements are the responsibility of the installer, i.e. cables wiring and loudspeakers should comply with IEC60849. Responsibility of the installer..	

6. Installation requirements

Clause / Requirement	Compliance	Signature
The system shall be installed in accordance with IEC60364 or with mandatory national or local standards.	Responsibility of the installer.	
If the emergency sound system forms part of an emergency detection and/or alarm system, the cabling shall meet the requirements of mandatory national or local, emergency and/or alarm system standards. Where the application specifically excludes detection and/or alarm, the cabling shall be of a standard suitable for the application.	Responsibility of the installer.	
Precautions shall be taken to prevent the spread of hazardous effects via the wiring routes.	Responsibility of the installer.	

Clause / Requirement	Compliance	Signature
When a sound system for emergency purposes is installed in combination with an emergency detection system, the installation standards for the sound system shall comply as far as is applicable with the standards required for that detection system.	Responsibility of the installer.	
When additions and/or modifications are made to a non-compliant system the existing system may require to be upgraded to meet this standard. In all cases the additions and/or modifications shall meet this standard.	Responsibility of the installer.	

7. Instructions for use

Clause / Requirement	Compliance	Signature
7.1 Instructions for operation		
Instructions for the operation of the system, including actions to be taken in accordance with established and well-rehearsed procedures, shall be available for rapid reference, preferably prominently and permanently displayed, at each control station.	Responsibility of the installer.	
As far as possible, graphic illustrations should be used: where text is necessary this should be clearly legible and in the preferred language(s).	Compliant. Availability of user instructions is the responsibility of the installer.	
Updating of the instructions for operation shall be carried out after additions to or modifications of the system, or on the basis of practical experience, or revised procedures.	Responsibility of the installer.	
Instructions shall include:		
– The functional operation of the system.	Responsibility of the installer.	
– Action to be taken in the event of a system failure.	Responsibility of the installer.	

Clause / Requirement		Compliance	Signature
A bound copy of the operational instructions shall be provided.		Compliant. A printed version of the English User Manual is provided and electronic copies in Dutch, French, German, Polish, Norwegian, Finnish, Swedish, Portuguese, and Spanish. The Installation and User Instruction are available electronically in English. Responsibility of the installer.	
7.2 Records to be kept			
Installation, logbook and maintenance records shall be kept by the end-user and/or maintenance company contracted by the end-user in accordance with relevant international and national standards. These shall comprise as a minimum:		Responsibility of the installer.	
a	Installation		
1	details of the locations of all items of the equipment.	Responsibility of the installer.	
2	“as installed” performance measurements of the system including:	Responsibility of the installer.	
	– measured loudspeaker loading per circuit in emergency mode.	Responsibility of the installer.	
	– settings of any adjustable items within the system, including the output level of power amplifiers.	Responsibility of the installer.	
	– sound pressure levels.	Responsibility of the installer.	
	– intelligibility measurements.	Responsibility of the installer.	
b	Log book		
A stiff covered log book shall be kept, in which all usage of the system and all fault occurrences should be recorded, together with all available automatically produced records, to include:		Responsibility of the person nominated by the person or body, having control of the premises (see 4.2).	
1	dates and times of usage of the system.		
2	details of tests and routine checks carried out.		

Clause / Requirement		Compliance	Signature
3	time and date of each fault occurrence.		
4	details of the fault found and the circumstances of it being found (for example during routine maintenance).		
5	action taken to rectify or remedy.		
6	date, time and name of person in charge of the system.		
7	countersignature of the responsible person, if any faults occurred or have been rectified.		
7.3 Maintenance			
7.3.1 General			
There shall be an established and documented procedure for the scheduled maintenance and retesting of the sound system and equipment as recommended by the system designer in conjunction with the equipment manufacturer and in accordance with relevant international and national standards. It is recommended that a minimum of two scheduled maintenance inspections, by a competent person, be made each year. A responsible person (see 4.2) shall be nominated to ensure that the procedure continues to be carried out correctly.		Responsibility of the installer to establish the maintenance procedures using the manufacturer documentation.	
7.3.2 Maintenance instructions			
A stiff-covered maintenance manual should be available giving details of all work required to maintain the installation and equipment in proper working order, consistent with specified performance criteria and any other requirements of this standard and other relevant international or national standards. This should state clearly:		Responsibility of the installer to establish the maintenance procedures using the manufacturer documentation.	
a	The method of maintenance.		
b	Any sequence related to maintenance.		

Clause / Requirement	Compliance	Signature
c Identification of parts requiring maintenance, giving reference to the location of items on drawings, together with manufacturer's reference numbers, and the addresses, telephone and facsimile numbers, of suppliers of materials and parts.	Preventive Maintenance: Vacuum cleaning of the Controller and the external power amplifier(s) every +/- 2 years (depending on the ambient dust). When used, vacuum clean the rack mounting filters of the cooling fans +/- 2 years (depending on the ambient dust). Prevent or remove animal nests (mice and rats can eat the cabling).	
d Original versions of equipment and materials catalogues.	Compliant. For this purpose retain the original data sheets and the Installation and Operation manuals.	
e List and location of spare parts.	Responsibility of the installer.	
f List and location of special tools.	N/a	
The maintenance instructions should also include:		
g Test certificates as required to be examined by the relevant authority.	Responsibility of the installer.	
h A set of "as fitted" drawings.	Responsibility of the installer.	

11.1.3

EN60849 - When using the Remote Control Kits:

The Plena Voice Alarm System Remote Control Kit and the Plena Voice Alarm System Remote Control Extension Kit are versions of the Remote Control and Remote Control Extension with connector interfaces instead of LED and buttons. These kits enable the use to built custom panels for the Voice alarm System. Functionality and firmware is identical to the remote control (extension). The compliancy to IEC60849 is valid as long as the buttons and LED's/ lamps are connected correctly. This should be done by a qualified electrician. Furthermore the final installation should always be tested according to the above standard to ensure proper functioning.

When installing in a 19" rack please ensure the following:

- Ventilation requirements are met and ambient temperature inside rack is below 55 degrees.
- Indications are visible from the outside.
- The sounder is audible.
- Access level control is met if applicable.
- The rack is properly grounded.

11.1.4

EN54-16

EN54-16 is a product standard governing 'Voice Alarm Control and Indicating Equipment' (VACIE) which is issued by the European Union Construction Product Directive (CPD), also known as Directive 89/106/EEC. This EU directive ensures that all products sold in the European Union are safe to use and install.

The CPDs with numbers 560-CPD-10219002/AA/00 and 1438/CPD/0209, issued by Notified Certification Bodies, are valid for the products listed in the table below, which are part of the Plena Public Address and Emergency Sound System.

The following firmware versions have been certified according EN54-16:

- 2.16.04
- 2.16.05
- 3.00.01
- 3.00.02
- 3.00.03

To configure the system, the PC software version and firmware version has to match.

To be compliant to EN54-16, the firmware of the controller and routers has to be the same. Certified has been:

Unit Type	Description	HW version
LBB 1990/00	Controller	2.0 - 3.0
LBB 1992/00	Router	2.0 - 3.0
LBB 1995/00	Fireman's panel	1.0 - 2.0
LBB 1996/00	Remote Control	1.0 - 2.0
LBB 1997/00	Remote Control Extension	1.0 - 2.0
LBB 1935/20	Power Amplifier 360/240W	2.0 - 3.0
LBB 1938/20	Power Amplifier 720/480W	2.0 - 3.0
PLN-1P1000	Power Amplifier 1000W	2.0 - 3.0
PLN-1LA10	Loop Amplifier	1.0

You can check the firmware version of connected Voice Alarm Components with the PC configuration program. If the firmware version of any of the components is older, you can upgrade the LBB 1990/00 and LBB 1992/00 if needed. Also print and fill in the EN54-16 checklist that could be download from the Installation and User Instructions software directory from the Plena Voice Alarm System product related information on www.boschsecurity.com, and affix the EN54-16 label to the cabinet.

Backward compatibility of the firmware

Firmware (f/w) compatibility	Hardware (h/w) / Version	Firmware (f/w) versions allowed				
		2.16.04	2.16.05	2.16.07	3.00.01	3.00.02
Units		2.16.04	2.16.05	2.16.07	3.00.01	3.00.02
Controller LBB 1990/00	2.0	Yes	Yes	Yes	Yes	Yes
	3.0	No	Yes*	Yes	Yes	Yes
Router LBB 1992/00	2.0	Yes	Yes	Yes	No	Yes
	3.0	Yes	Yes	Yes	Yes	Yes

(*): This software version does not recognize the latest version USB controller ISP1763.

Yes means, you can run the firmware in top row on the hardware version indicated. If you do upgrade or downgrade, the controller will indicate faults, after up or downgrading you must update the configuration. The configuration files are not backward compatible. You must create a new configuration file and make sure you do not mix them up.

Part of EN54-16 compliancy is to have a well documented system. This includes correct naming and storing of configuration files.



Notice!

Firmware version 2.16.07 is identical to 2.16.05 except the handling of the USB controller IC.

The following f/w versions are available:
2.16.05, 2.16.07, 3.00.02.



Notice!

Router 2.0 h/w will need a hardware change to operate 3.00.02 f/w. This is not supported or recommended.

Interoperability of the hardware

	Controller		
Router	-	2.0	3.0
	2.0	OK	OK*
	3.0	OK	OK

Controller/Router	>>>>>>>>>	2.0/2.0	2.0/3.0	3.0/2.0	3.0/3.0
Amplifier	2.0	OK	OK	OK	OK
	3.0	OK	OK	OK	OK
LBB 1995/00	2.0	OK	OK	OK	OK
LBB 1996/00	2.0	OK	OK	OK	OK

Controller/Router	>>>>>>>>>>	2.0/2.0	2.0/3.0	3.0/2.0	3.0/3.0
LBB 1997/00	2.0	OK	OK	OK	OK
LBB 1998	2.0	OK	OK	OK	OK
LBB 1999	2.0	OK	OK	OK	OK

To use a 3.0 controller with 2.0 routers, you must downgrade the controller to 2.16.05 or 2.16.07. You will not have the functionality and bugfixes of 3.00.01 or 3.00.02. You may use 2.0 h/w routers on 3.0 controllers with the controller running 3.00.02, as router 1-9. This option is available when expanding systems. We recommend that the same h/w version and same f/w are used in one system. We recommend that the leading number matches, so if possible install 2.x firmware on 2.x hardware, and only install 3.x f/w on 3.x h/w.



Notice!

For more information, manual addenda and release notes, check the 3.00.xx or 2.16.05 Plena Voice Alarm System product related information on www.boschsecurity.com.



Notice!

When upgrading the controller firmware from version 2.16.05 to 3.00.0x, the configuration has to be made again in the 3.00.0x PC software and uploaded into the controller again. It is not possible to load configuration if the PC software version does not match the firmware version.

Windows 7 compatibility

Version 3.0 will run on Windows 7 Professional or Ultimate. Be sure that the user has local admin rights.

Checklist EN54-16

Print and fill in the EN54-16 checklist that could be download from the Installation and User Instructions software directory from the Plena Voice Alarm System product related information on www.boschsecurity.com, and affix the EN54-16 label to the cabinet. The label will look similar to this:

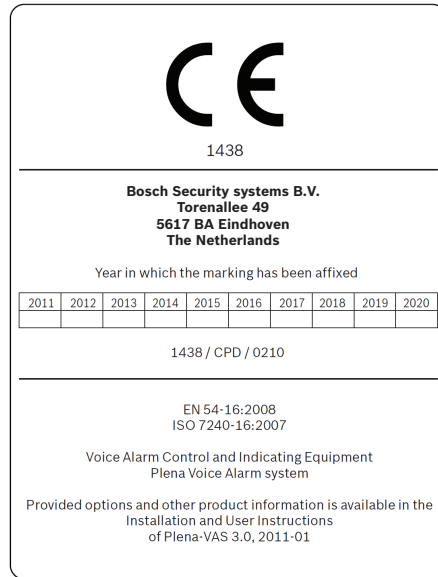

label dimensions: 125 x 165 mm

Figure 11.1: EN54-16 label

	Installer	End-user
Name:		
Signature:		
Date:		
Place:		

4 General Requirements

Clause / Requirement	Compliance	Signature
4.1 General	Plena is compliant.	
<p>4.1.1 If an optional function with requirements is included in the VACIE, then all the corresponding requirements shall be met (see Annex B).</p>	<p>The following optional functions, with requirements, are included in Plena Voice Alarm System:</p> <ul style="list-style-type: none"> – Audible warning (7.3) – Manual silencing of the voice alarm condition (7.6.2) – Manual reset of the voice alarm condition (7.7.2) – Voice alarm condition output (7.9) – Indication of faults related to the transmission path to the CIE (8.2.6) – Indication of fault related to voice alarm zones (8.2.7) – Voice alarm manual control (10) – Emergency microphone(s) (12) – Microphone priority (12.2) – Redundant power amplifiers (13.14) <p>The following optional functions with requirements are not included in Plena Voice Alarm System:</p> <ul style="list-style-type: none"> – Delay(s) to entering the voice alarm condition (7.4) – Phased evacuation (7.5) – Output to fire alarm devices (7.8) – Disabled condition (9) – Interface to external control device(s) (11) 	
<p>4.1.2 If functions other than those specified in this European Standard are provided, they shall not jeopardize compliance with any requirements of this European Standard</p>		
4.2 Combined VACIE and CIE		
<p>When the VACIE and CIE are combined they may share common indications, manual controls and outputs (see Annex F). In this case, the following shall apply:</p>	<p>This requirement is not applicable. In Plena Voice Alarm System, the Voice Alarm Control and Indicating Equipment (VACIE) is not combined with a fire alarm Control and Indicating Equipment (CIE).</p>	

Clause / Requirement		Compliance	Signature
a	single fault in the CIE shall not adversely affect the mandatory functions of the VACIE;		
b	indication(s) and manual control(s) of the voice alarm condition shall be clearly identifiable, with the exception of the optional audible warning.		
4.3 Power supply		Plena Voice Alarm System is compliant.	
	Power supply equipment, external or included in the VACIE, shall comply with the requirements of EN 54-4.	It is the responsibility of the installer to use power supplies and battery charging equipment in accordance with EN 54-4. The PLN-24CH12 is compliant to EN54-4.	
	NOTE - The power supply may be shared with that of the fire detection and fire alarm system.	The power supply may be shared with that of a fire detection system, but when operated with a battery a new capacity calculation is required.	

5 General requirements for indications

Clause / Requirement		Compliance	Signature
5.1 Display and functional conditions		Plena Voice Alarm System is compliant.	
5.1.1	The VACIE shall be capable of unambiguously indicating the following functional conditions, as described in Clauses 6 to 9: <ul style="list-style-type: none"> - quiescent condition; - voice alarm condition; - fault warning condition; - disablement condition (option with requirements) 	See Clauses 6 to 9. Plena Voice Alarm System does not have a disablement function.	
5.1.2	The VACIE shall be capable of being simultaneously in any combination of the following functional conditions on different voice alarm zones:	The Plena Voice Alarm System is capable of being simultaneously in the voice alarm condition and in the fault warning condition.	

Clause / Requirement	Compliance	Signature
– voice alarm condition;	The voice alarm condition is indicated on each call station (system status LED), remote control or fireman's panel and on the display of the controller This system wide indication can be combined with the indication of the fault warning condition: the controller gives an audible warning on EMG condition that has priority over the audible fault signal. EMG condition is indicated by a red LED, faults by corresponding yellow LEDs, therefore both conditions can be indicated simultaneously.	
– fault warning condition;	The fault warning condition is indicated on each call station (system status LED), remote control or fireman's panel and on the display of the controller (faults menu). This system wide indication can be combined with the indication of the voice alarm condition The display of the controller can indicate both the voice alarm condition and the fault warning.	
– disablement condition (option with requirements).	The optional disablement condition is not implemented in Plena Voice Alarm System.	
5.2 Indication display	Plena Voice Alarm System is compliant.	
All mandatory indications shall be clearly identifiable, except where otherwise specified in this European Standard.	The Plena Voice Alarm System uses the following color coding for indications throughout the system: <ul style="list-style-type: none"> – Green: system ok – Red: system/zone in voice alarm condition – Yellow: system in fault warning condition 	
5.3 Indication on alphanumeric displays	Not applicable.	

Clause / Requirement	Compliance	Signature
<p>Where an alphanumeric display is used to display indications relating to different functional conditions these may be displayed at the same time. However, for each functional condition there shall be only one window, in which all of the information relating to that functional condition is grouped.</p>	<p>The front panel of the controller and remote control panels have a field with LEDs that have specific fault assigned to them. Each zone has a separate LED to signal a fault in that zone.</p> <p>If a zone on a router is in fault condition. The main controller will signal a router fault and the router will indicate which zone.</p> <p>The logging application delivered with the Plena Voice Alarm System offers a graphical user interface for viewing events (Logging Viewer).</p>	
<p>5.4 Indication of the supply of power</p>	<p>Plena Voice Alarm System is compliant.</p>	
<p>5.4.1 A visible indication shall be given by means of a separate discrete light-emitting indicator while the VACIE is supplied with power.</p>	<p>Each Plena Voice Alarm System component has a dedicated power LED.</p>	
<p>5.4.2 Where the VACIE is distributed in more than one cabinet, an indication of supply of power to each distributed cabinet shall be given at that point.</p>	<p>The Plena Voice Alarm System can be distributed in more than one cabinet, depending on the installation of the system. Many system components can be mounted in a 19" rack. Each cabinet will indicate supply of power independently if the system is distributed in more than one cabinet.</p>	
<p>5.5 Additional indications</p>	<p>Plena Voice Alarm System is compliant.</p>	
<p>Where additional indications are provided, they shall be clearly identifiable and shall not override the primary indication of the VACIE.</p>	<p>For LEDs with multiple indication functions, all of the additional indications are clearly identified (in the Installation and User Instructions of the Plena Voice Alarm System); since the fault warning indication and the voice alarm indication always have precedence over the additional indications, the primary indications are not overridden. Almost all LEDs indicate a single function.</p>	

6 The quiescent condition

Clause / Requirement	Compliance	Signature
Any kind of system information may be displayed during the quiescent condition. However, no indications shall be given which could be confused with indications used in the	Plena Voice Alarm System is compliant.	
– voice alarm condition,	If the Plena Voice Alarm System enters the voice alarm condition, controller, remote control panels (including fireman's panel), and each call station will show a red system status LED. In the quiescent condition no red indicators are used at all and the display of the controller will never automatically switch to the emergency menu.	
– fault warning condition,	If the Plena Voice Alarm System enters the fault warning condition each call station will show a yellow fault LED. Yellow LEDs are solely used for fault condition.	
– disablement condition (option with requirements).	The disablement condition is not implemented in Plena Voice Alarm System.	

7 The voice alarm condition

Clause / Requirement	Compliance	Signature
7.1 Reception and processing of fire signals	Plena Voice Alarm System is compliant.	
7.1.1 The VACIE shall be capable of receiving and processing alarm signals from the CIE or from manual control on the VACIE or both, and causing the appropriate voice alarm outputs to be activated within 3 s or on expiry of any delay period (see 7.4).	Alarm signals from the CIE can be received from input contacts and the Open Interface. Manual control is possible via the controls and input contacts. Note the call stations are not part of the voice alarm function and are disabled in the alarm condition.	

Clause / Requirement	Compliance	Signature
<p>NOTE - See Annex E for additional information relating to the interface between the VACIE and the CIE.</p>	<p>If input contacts are used for connection of the CIE to the Plena Voice Alarm System then the input contacts can be monitored for short circuit and open line. If the Open Interface is used for connection of the CIE to the VACIE, the communication is monitored using keep-alive messaging.</p>	
<p>7.1.2 The mandatory indications and or outputs shall not be falsified by multiple alarm signals received simultaneously from the CIE and/or manual controls.</p>	<p>The Plena Voice Alarm System offers one alarm priority.</p>	
<p>7.1.3 Where the VACIE and CIE are in separate cabinets, failure of the transmission path between the CIE and the VACIE shall not result in any loss of control or any change of state of the VACIE.</p>	<p>The Plena Voice Alarm System is an autonomous subsystem that can operate without connection to the CIE. The effect of the failure of the transmission path between the CIE and the Plena Voice Alarm System is limited to fault reporting and losing interaction between the CIE and the Plena Voice Alarm System. The system must be configured correctly for this.</p>	
<p>7.2 Indication of the voice alarm condition</p>	<p>Plena Voice Alarm System is compliant.</p>	
<p>7.2.1 The presence of a voice alarm condition shall be indicated on the VACIE, without prior manual intervention, by:</p>		
<p>a a visible indication by means of a separate discrete light emitting indicator (the General Voice Alarm Activated indicator);</p>	<p>A voice alarm condition is indicated on the Plena Voice Alarm System by:</p> <ul style="list-style-type: none"> - A red indicator on all call stations (the system status LED). - A textual indicator on the controller display. - A red indicator on the controller. 	
<p>b a visible indication for each activated voice alarm zone where manual controls are provided (see 10.2);</p>	<p>The controller and routers have a separate LED per zone to indicate activation of all zones.</p>	

Clause / Requirement		Compliance	Signature
NOTE - This may be by means of separate discrete indicators or an alphanumeric display as specified in 13.8.			
c	an optional audible indication, as specified in 7.3.	The controller and remote control panels (including fireman's panel), have a built-in sounder.	
7.2.2 The audible warning shall be capable of being silenced at access level 1 or 2.		The sounder (see 7.2.1.c) can be silenced by acknowledging the voice alarm condition. The voice alarm condition can be acknowledged by means of an input contact, manual operation at the controller or remote control panels or via the Open Interface.	
7.3 Audible warning (option with requirements)			
An audible warning of the voice alarm condition might be the same as that for the fault warning condition. If they are different, the voice alarm condition warning shall have priority.		The voice alarm condition is indicated by an audible warning on EMG condition that has priority over the audible fault signal. The EMG condition is indicated by an intermittent tone, the fault condition by a continuous tone.	
7.4 Delays to entering the voice alarm condition (option with requirements)			
The VACIE may be provided with a facility to introduce a delay before entering the voice alarm condition. In this case:		Since the Plena Voice Alarm System does not process the fire sensors, this functionality is better handled by the device managing the fire sensors (the CIE). The Plena Voice Alarm System itself does not implement this requirement.	
a	the operation of the delay shall be selectable at access level 3;		
b	the operation of the delay shall be in increments not exceeding 1 min up to a maximum of 10 min;		
c	the delay to one output signal shall not affect the delay to other outputs;		
d	it shall be possible to override the delay by a manual operation at access level 1;		

Clause / Requirement	Compliance	Signature
e there shall be provision to switch on and switch off delays by means of a manual operation at access level 2 (see Annex A for information on access levels);		
f there may be provision to automatically switch on and/or switch off delays by means of a programmable timer which shall be configurable at access level 3;		
g a separate discrete light emitting indicator and/or a field on the alphanumeric display shall be visible when a fire signal is received and the delay activated. This indication shall be suppressed when the VACIE enters the voice alarm condition.		
7.5 Phased evacuation (option with requirements)	Plena Voice Alarm System does not accommodate phased evacuation.	
The VACIE may have a provision to phase the warning signals to the emergency loudspeaker zones. The facility shall be configurable at access level 3. There may be provision to switch on and switch off the phased evacuation sequence by means of a manual operation at access level 2 (see Annex A for information on access levels).		
7.6 Silencing of the voice alarm condition	Plena Voice Alarm System is compliant.	
7.6.1 Silencing of the voice alarm condition from the CIE		
7.6.1.1 Where the voice alarm condition has been triggered from the CIE, the VACIE shall respond appropriately to a silence instruction from the CIE.	Voice alarm calls triggered from the CIE can also be stopped from the CIE. To reset the voice alarm condition an Acknowledge Emergency is possible for CIE and on the front panels of the controller and remote control panels.	

Clause / Requirement	Compliance	Signature
<p>7.6.1.2 The silencing procedure may allow for the completion of messages in the process of being broadcast.</p>	<p>If a voice alarm call is activated from the contacts it is configurable whether or not to stop or finish the message. If the alarm condition is reset from the front panel or the call is aborted from the front panel of the controller and remote control panels, the message is topped immediately.</p>	
<p>7.6.2 Manual silencing of the voice alarm condition (option with requirements)</p>		
<p>7.6.2.1 It shall be possible to manually silence the voice alarm message from the VACIE at access level 2.</p>	<p>Plena Voice Alarm System offers the possibility to stop voice alarm calls by de-activating (or re-activating) the contact or key that started the call, or. By using the front panel key on the controller or remote control panels, the messages can be routed differently, or overruled.</p>	
<p>7.6.2.2 Following silencing, it shall be possible to re-activate the voice alarm message at access level 2.</p>	<p>Voice alarm call can be re-activated by starting that call again from a contact, routing it to the zone(s) again.</p>	
<p>7.7 Reset of the voice alarm condition</p>	<p>Plena Voice Alarm System is compliant.</p>	
<p>7.7.1 Reset of the voice alarm condition from the CIE</p>		
<p>Where the voice alarm condition has been triggered from the CIE, the VACIE shall respond appropriately to a reset instruction from the CIE.</p>	<p>See 7.6.1.1.</p>	
<p>7.7.2 Manual reset of the voice alarm condition (option with requirements)</p>		
<p>7.7.2.1 It shall be possible to reset the voice alarm condition from the VACIE at access level 2 by means of a separate manual control. This control shall be used only for reset and may be the same as that used for reset from the fault warning condition.</p>	<p>To reset the voice alarm condition an Acknowledge Emergency and Reset Emergency action is required. Plena Voice Alarm System has dedicated acknowledge and reset buttons on the front panel of the controller and remote controls.</p>	

Clause / Requirement	Compliance	Signature
<p>7.7.2.2 Following a reset operation, the indication of the correct functional condition corresponding to any received signals shall either remain or be re-established within 20 s.</p>	<p>After a reset operation, the Plena Voice Alarm System will immediately indicate the functional condition it is currently in. It will also immediately (<<1 s) respond to received signals that will bring it into another functional condition.</p>	
<p>7.8 Output to fire alarm devices (option with requirements)</p>	<p>This option is not supported by the Plena Voice Alarm System.</p>	
<p>In addition to the voice alarm outputs the VACIE may have provision for the automatic transmission of fire alarm signals to fire alarm devices such as beacons and vibrating devices. In this case, the following shall apply:</p>		
a	<p>it shall be possible to de-activate the fire alarm devices at access level 2;</p>	
b	<p>following de-activation, it shall be possible to re-activate the fire alarm devices at access level 2;</p>	
c	<p>the fire alarm devices shall not be de-activated automatically;</p>	
d	<p>it shall be possible to configure the VACIE at access level 3 to automatically reactivate the fire alarm devices if an alarm is reported in an other zone.</p>	
<p>7.9 Voice alarm condition output (option with requirements)</p>	<p>Plena Voice Alarm System is compliant.</p>	
<p>The VACIE may have provision for transmitting a signal that is in the voice alarm condition. In this case, it shall activate the output only in the voice alarm condition.</p>	<p>The Plena Voice Alarm System transmits a signal that it is in the voice alarm condition via the Open Interface, and via the status contact.</p>	

8 Fault warning condition

Clause / Requirement	Compliance	Signature
8.1 Reception and processing of fault signals	Plena Voice Alarm System is compliant.	
8.1.1 The VACIE shall enter the fault warning condition when signals are received which, after any necessary processing, are interpreted as a fault.	When the Plena Voice Alarm System receives a supervision fault signal (i.e. detects a fault in the system), the fault warning condition is entered until this state is explicitly reset.	
8.1.2 The VACIE shall be capable of simultaneously recognizing all of the faults specified in 8.2 and, if provided, in 8.3 unless this is prevented by:		
– the presence of an alarm output signal on the same voice alarm zone, and/or	All Plena Voice Alarm System faults are handled (acknowledged and reset) collectively. The faults are indicated individually, if a contact is configured as fault input, it may indicate a fault in a zone groups or individual zones, responsibility of the installer.	
– the disablement of the corresponding voice alarm zone or function, and/or	Optional disablement of voice alarm zones or functions is not implemented in Plena Voice Alarm System.	
8.1.3 The VACIE shall enter the fault warning condition within 100 s of the occurrence of any fault, or the reception of a fault signal or within another time as specified in this European Standard or in other parts of EN 54.	The Plena Voice Alarm System recognizes and reports all faults within 100 seconds.	
8.2 Indication of faults in specified functions	Plena Voice Alarm System is compliant.	
8.2.1 The presence of faults in specified functions shall be indicated on the VACIE without prior manual intervention. The fault warning condition is established when the following are present:		

Clause / Requirement		Compliance	Signature
a	a visible indication by means of a separate light emitting indicator (the general fault warning indicator);	The Plena Voice Alarm System provides a visible indication when it is in the fault warning condition via the fault LEDs of the of the call stations, output contacts, and front panels of controller, routers and remote control panels. Additionally the is a fixed fault output contact on the controller.	
b	a visible indication for each recognized fault as specified in 8.2.4, and 8.2.5, 8.2.6, 8.2.7, if provided, and 8.3;	The Plena Voice Alarm System offers two ways of visual indication of individual faults: via the front panel of the controller, router, and remote control panels and via the Plena Voice Alarm System logging application.	
c	an audible indication, as specified in 8.4.	The Plena Voice Alarm System provides an audible fault indication from the controller and remote control panels.	
8.2.2 If the indication is by means of separate light-emitting indicators, these may be the same as those to indicate disablement of the corresponding alarm zones or functions.		The optional function 'disablement' is not implemented in Plena Voice Alarm System.	
8.2.3 If the indication is on an alphanumeric display, which cannot simultaneously indicate all of the faults because of its limited capacity, at least the following shall apply:			
a	the presence of fault indications which have been suppressed shall be indicated;	Plena Voice Alarm System does not have an alphanumeric display.	
b	suppressed fault indications shall be capable of being displayed by means of a manual operation at access level 1 or 2 which interrogates only fault indications.		
8.2.4 The following faults shall be indicated by means of separate light emitting indicators and/or an alphanumeric display:		Plena Voice Alarm System is compliant.	

Clause / Requirement		Compliance	Signature
a	an indication at least common to any power supply fault resulting from:	The mains and backup power of all Plena Voice Alarm System elements are supervised individually, depending on configuration. The controller and routers monitor the power sources on a system level.	
	– a short circuit or an interruption in a transmission path to a power supply (item L of Figure 1 of EN 54-1), where the power supply is contained in a different cabinet from that of the VACIE, and		
	– the power supply faults as specified in EN 54-4;		
b	an indication at least common to any earth fault of less than 50 kW is capable of affecting a mandatory function, and which is not otherwise indicated as a fault of a supervised function;	All 100V lines of the Plena Voice Alarm System are supervised individually for earth faults (i.e. connections to earth with a leakage resistance of less than 50 k Ohm).	
c	an indication of the rupture of any fuse within the VACIE, or the operation of any protective device within the VACIE which is capable of affecting a mandatory function in the fire alarm condition;	Every rupture of a fuse or the operation of a protected device that affects a mandatory function will result in a fault since the mandatory functions are supervised. The reported fault is as close to the located defect as possible. E.g. a mains related fault is reported as a mains fault and an amplifier defect is reported as defect for that amplifier.	
d	an indication of any short circuit or interruption, at least common to all transmission paths between parts of the VACIE contained in more than one cabinet, which is capable of affecting a mandatory function and which is not otherwise indicated as a fault of a supervised function.	All transmission paths of the Plena Voice Alarm System are supervised. All control input contacts of the Plena Voice Alarm System can be supervised for shorts and interruptions. Analog audio connections to external parties can be supervised by pilot tone supervision.	

Clause / Requirement		Compliance	Signature
	These indications may be suppressed during the fire alarm condition.	Plena Voice Alarm System fault indicators are not suppressed. There are separate indicators for fault and voice alarm conditions. The only exception is the audible indicator.	
8.2.5 The following faults shall be indicated at least by means of the general fault warning indicator:			
a	any short-circuit or interruption in a voice alarm transmission path between parts of the VACIE contained in more than one cabinet even where the fault does not affect a mandatory function;	All transmission paths of the Plena Voice Alarm System are supervised. When the Plena Voice Alarm System is used in a redundant loop configuration, the loss of the redundant path is reported. All control input contacts of the Plena Voice Alarm System can be supervised for shorts and interruptions. Analog audio connections to external parties can be supervised by pilot tone supervision.	
b	any short-circuit or interruption in the voice alarm transmission path to the emergency microphone capsule, if provided;	The capsule of the Plena Voice Alarm System emergency microphone can be supervised for both short-circuit and interruption. This is configurable.	
c	any short-circuit or interruption in the voice alarm transmission path between the VACIE and loudspeakers even where the fault does not affect the operation of loudspeakers.	The loudspeaker lines of the Plena Voice Alarm System can be supervised.	

Clause / Requirement	Compliance	Signature
d any short-circuit or interruption in the transmission path between the VACIE and fire alarm devices when used (see 7.8).	The Plena Voice Alarm System does not offer this functionality directly: control inputs are supervised, but control outputs are voltage free relay contacts. It is the responsibility of the installer to create a feedback signal (corresponding to the transmission path status between the Plena Voice Alarm System and the fire alarm device) to a supervised input contact of the Plena Voice Alarm System.	
e failure of any power amplifier.	All Plena Voice Alarm System power amplifiers are supervised for overload, overheating, short-circuit, ground short and amplifier defect.	
8.2.6 Indication of faults related to the transmission path to the CIE (option with requirements)		
The VACIE may have provision for an indication of faults related to the transmission path to the CIE. In this case, the short-circuit or interruption of the transmission path to the CIE shall be indicated by means of a separate light emitting indicator and/or an alphanumeric display.	Plena Voice Alarm System is compliant. All input contacts of the Plena Voice Alarm System can be supervised for short and interruption. Open Interface connections are supervised through keep-alive messaging. Faults related to the transmission path to the CIE are therefore individually reported and can be inspected using the front panel of the controller or the logging application. The faults are also reported through the general fault warning indication.	
8.2.7 Indication of faults related to voice alarm zones (option with requirements)		

Clause / Requirement	Compliance	Signature
<p>The VACIE may have provision for an indication of faults related to voice alarm zones. In this case the short-circuit or interruption of a voice alarm transmission path between the VACIE and the loudspeakers in that zone shall be indicated by means of a separate light emitting indicator per zone and/or an alphanumeric display.</p>	<p>Plena Voice Alarm System is compliant.</p> <p>Faults that occur in the Plena Voice Alarm System are reported per defective zone or monitored function.</p>	
<p>8.3 System fault</p>	<p>Plena Voice Alarm System is compliant.</p>	
<p>A system fault is a fault as specified in 14.4 Program monitoring (see also Annex C) or 14.6 Monitoring of memory contents in the case of software controlled VACIE. A system fault may prevent requirements of this European Standard, other than those specified below, from being fulfilled. In the event of a system fault at least the following shall apply:</p>		
<p>a a system fault shall be visibly indicated by means of the general fault warning indicator and a separate light emitting indicator on the VACIE. These indications shall not be suppressed by any other functional condition of the VACIE and shall remain until a manual reset and/or another manual operation at access level 2 or 3;</p>	<p>System faults are individually reported by the Plena Voice Alarm System and can be inspected using the front panel menu of the controller or the logging application.</p> <p>Faults are also reported through a general fault warning indicator, connected to a control output.</p> <p>Both the individual fault indicator of each system fault and the general fault warning indicator are not suppressed by any other functional condition of the Plena Voice Alarm System.</p>	

Clause / Requirement		Compliance	Signature
b	a system fault shall be audibly indicated. This indication may be capable of being silenced.	The controller and remote control panels all have a monitor speaker that is used as a sounder in case of a fault. The audible fault indicator can be silenced by acknowledging all faults via a button on the front panel of the controller and remote control panels. The control output for the visible fault indicator is only deactivated upon resolving and resetting the fault condition.	
8.4 Audible indication		Plena Voice Alarm System is compliant.	
8.4.1	The audible indication of faults required in 8.2 shall be capable of being silenced manually at access level 1 or 2 at the VACIE. The same manual operation may be used as for silencing the voice alarm condition.	The audible fault indicator can be silenced by acknowledging all faults via a key or control input that is configured as Fault acknowledge key. Individual faults can also be acknowledged from the front panel menu of the controller or via the Open Interface.	
8.4.2	The audible indication shall be silenced automatically if the VACIE is automatically reset from the fault warning condition.	Since the Plena Voice Alarm System does not offer automatic reset from the fault warning condition this requirement does not need to be implemented.	
8.4.3	If previously silenced, the audible indication shall resound for each newly recognized fault.	After the audible indication has been silenced (by acknowledging all faults) the Plena Voice Alarm System will resound the indication upon occurrence of a new fault or reoccurrence of a previously resolved fault.	
8.5 Reset of fault indications		Plena Voice Alarm System is compliant.	
8.5.1 Indications of faults as required in 8.2 shall be capable of being reset			
a	automatically when faults are no longer recognized, and/or	The Plena Voice Alarm System does not offer automatic reset of faults	

Clause / Requirement	Compliance	Signature
b by a manual operation at access level 2.	Faults can be manually reset by acknowledging and resetting them. Acknowledging and/or resetting faults individually (as they appear) can be done via the front panel menu of the Controller and via the Open Interface. Acknowledging and/or resetting will acknowledge/reset all faults in one action, This can be done via the front panel button of the controller, remote control panels or the Open Interface.	
8.5.2 Following reset, the indication of the correct functional conditions corresponding to any received signals shall either remain or be re-established within 20 s.	If faults are reset, all individual faults that are not actually resolved in the system are reported again within 20 seconds. The sounder will not resound. the system checks reported fault first immediately. If the faults are resolved when the reset is done, and the fault reappear shortly afterward the sounder will resound.	
8.6 Transmission of the fault warning condition	Plena Voice Alarm System is compliant.	
The VACIE shall have provision for transmitting, by means of at least general fault signal, all faults specified in 8. This fault signal shall also be given if the VACIE is de-energized.	The Plena Voice Alarm System controller has a fixed fault output. This relay output contact indicates no fault when open (energized) and indicates a fault when closed (de-energized). If the Plena Voice Alarm System is de-energized this output contact is closed, therefore the fault signal will also be given.	

9 Disablement condition (option with requirements)

Clause / Requirement	Compliance	Signature
9.1 General requirements	Plena Voice Alarm System does not support the disablement condition.	
9.1.1 Disablements in accordance with the requirements of 9.4 shall inhibit all corresponding mandatory indications and/or outputs but shall not prevent other mandatory indications and/or outputs.		
9.1.2 The VACIE shall have provision to independently disable and re-enable the function specified in 9.4 by means of manual operations at access level 2.		
9.1.3 The VACIE shall be in the disabled condition while a disablement in accordance with the requirements of 9.4 exists.		
9.1.4 Disablement and re-enablement shall not be affected by a reset from the voice alarm condition or from the fault warning condition.		
9.2 Indication of the disabled condition		
The disabled condition shall be indicated visibly, by means of		
a a separate light emitting indicator (the general disablement indicator), and		
b an indication for each disablement, as specified in 9.3 and 9.4.		
9.3 Indication of specific disablements		
9.3.1 Disablements shall either be indicated within 2 s of the completion of the manual operation or, where a disablement cannot be completed within 2 s, it shall be indicated within 2 s that the disabling process is running.		
9.3.2 The same light-emitting indicator may be used as that for the indication of the corresponding fault, although the indication shall be distinguishable.		

Clause / Requirement	Compliance	Signature
<p>9.3.3 If the indication is on an alphanumeric display, which cannot simultaneously indicate all of the disablements because of its limited capacity, at least the following shall apply:</p>		
<p>a the presence of disablement indications which have been suppressed shall be indicated;</p>		
<p>b suppressed disablement indications shall be capable of being displayed by means of a manual operation at access level 1 or 2 which interrogates only disablement indications.</p>		
<p>9.4 Disablements and their indication</p>		
<p>Voice alarm zones may be capable of being independently disabled and re-enabled. In this case the disablements shall be indicated by means of separate light emitting indicators per zone and/or an alphanumeric display. The indications shall not be suppressed during the voice alarm condition.</p>		
<p>9.5 Transmission of the disablement condition</p>		
<p>The VACIE shall have provision for transmitting, by means of a general disablement signal, all disablement conditions specified in this clause.</p>		

10 Voice alarm manual control (option with requirements)

Clause / Requirement	Compliance	Signature
<p>10.1 General requirements</p>	<p>Plena Voice Alarm System is compliant.</p>	
<p>The VACIE may have provision for manually activating the voice alarm output condition. If a voice alarm output control facility is provided the following shall apply:</p>		

Clause / Requirement	Compliance	Signature
<p>a a manual control which causes a voice alarm output condition to be given shall only be accessible at access level 2;</p>	<p>The Plena Voice Alarm System can enter the voice alarm output condition manually via controls on the front panel of the controller and remote control panels, via input contacts, and the Open Interface, by starting a call with a high enough priority.</p>	
<p>b it shall be possible to activate each voice alarm zone individually and/or in group(s) of voice alarm zones;</p>	<p>A voice alarm priority call can be manually activated in one or more individual zones or zone groups. Zone selection is possible via the front panels of the controller, router and remote control panels. Or via the Open Interface (e.g. using a PC Call Station for graphical representation of zones with mouse or touch screen selection). Zones can also be added to and removed from a running voice evacuation call using the front panels of the controller, router and remote control panels.</p>	
<p>c the manual activation of a voice alarm zone shall not prevent the mandatory indications and outputs to other voice alarm zones.</p>	<p>Plena Voice Alarm System has one channel for broadcasting. To ensure that a new emergency call does not affect a running call, the priorities of all calls have to be the same. Message merging and alternate broadcasting is supported responsibility of the installer. Plena Voice Alarm System will abort lower priority emergency calls if a call with higher priority is started. Non emergency audio is always stopped when entering the emergency state.</p>	
<p>10.2 Indication of the voice alarm zones in an activated condition</p>	<p>Plena Voice Alarm System is compliant.</p>	
<p>The indication for the voice alarm condition in the voice alarm zone(s) associated with each manual control shall be available without any manual action and shall not be suppressed. This indication shall be by means of</p>		

Clause / Requirement		Compliance	Signature
a	a separate light emitting indicator (the General Voice Alarm Output activated indicator), and	The voice alarm condition is indicated on the Plena Voice Alarm System in general by a red indicator inside the EMG button on the controller, routers and remote control panels.	
b	a separate light emitting indicator and/or alphanumeric display for each voice alarm zone and/or an indication for group(s) of voice alarm zones.	The voice alarm condition is indicated on the Plena Voice Alarm System per zone by a red indicator on the controller, routers and remote control panels.	
NOTE - These indicators may not necessarily indicate which emergency message is being broadcast in each voice alarm zone.			
10.3 Indication of the voice alarm zones in fault condition		Plena Voice Alarm System is compliant.	
The indication for the fault condition which would prevent the generation and transmission of the voice alarm signal to the voice alarm zone(s) associated with each manual control shall be available without any manual action and shall not be suppressed. This indication shall be by			
a	a separate light emitting indicator (the general fault indicator), and	Plena Voice Alarm System does not have a common fault indicator. A light emitting device must be connected to the general fault output to achieve this.	
b	an indication for each voice alarm zone and/or an indication for defined group(s) of zones.	The Plena Voice Alarm System provides a visible indication when it is in the fault warning condition via the fault LED of the corresponding zone for loudspeaker line related faults and key (mandatory) monitored elements. A fault indicator of an individual zone may indicate more than one fault. Common to those fault are that they occur in the indicated zone (e.g. loudspeaker line short circuit, open connection, ground short of the same zone).	

Clause / Requirement		Compliance	Signature
10.4 Indication of the voice alarm zones in disablement condition			
The indication for the disablement condition in the voice alarm zone(s) associated with each manual control shall be available without any manual action and shall not be suppressed. This indication shall be by		Plena Voice Alarm System does not support the optional disablement condition.	
a	a separate light emitting indicator (the general disablement indicator), and		
b	an indication for each voice alarm zone and/or an indication for defined group(s) of zones.		

11 Interface to external control device(s) (option with the requirements)

Clause / Requirement		Compliance	Signature
The VACIE may have provision for interfacing to external control device(s) such as standardized user interfaces required by local regulations. In this case, the following shall apply:		Plena Voice Alarm System does not support the Interface to external control device(s) option.	
a	the interface shall allow only access level 1 and 2 functions;		
b	the mandatory functions of the VACIE shall not be overridden;		
c	any short-circuit, interruption or earth fault in the transmission path to the external device(s) shall		
	– not prevent the mandatory function of the VACIE, and		
	– be indicated on the VACIE, at least by means of the general fault warning indicator.		
NOTE - The external control devices should comply with available local or national standards.			

12 Emergency microphone(s) (option with requirements)

Clause / Requirement	Compliance	Signature
12.1 General	Plena Voice Alarm System is compliant.	
The VACIE may have provision for emergency microphone(s). In this case the emergency microphone(s) shall have	Plena Voice Alarm System offers two types of emergency microphones with microphone supervision: <ul style="list-style-type: none"> – the emergency microphone on the controller; – the emergency microphone on the remote control panels. 	
a priority over all inputs, including pre-recorded messages,	The priority can be configured of a call station. The call stations cannot start an emergency message. The trigger inputs can have emergency priorities, but will always be lower than the emergency microphones. The emergency microphone can have different priority levels.	
b an emergency microphone control to open the microphone channel,	All emergency microphones have a push to talk (PTT) button built in.	
c an indication of any short circuit or interruption in the voice alarm transmission path to the microphone,	The microphone of a emergency microphones (capsule and wiring) can be configured to be supervised.	
d where a pre-announcement attention drawing signal is provided, an indicator adjacent to the microphone shall show when the signal has finished and live speech can commence, and	The voice alarm system has a built in monitor speaker and LED indications of a running emergency call. Pressing the emergency microphone will always override the automated message.	

Clause / Requirement	Compliance	Signature
<p>e when the emergency microphone control is operated, any audible indication that might interfere with the use of the microphone shall be automatically muted.</p>	<p>The monitor speaker is muted during the live speech phase. All sounders are acknowledged by the use of the emergency microphone. Microphone and sounder are always at the same location, front panels of controller and remote control panels.</p> <p>Other sources of interference should be minimized by proper installation, e.g. keep HVAC equipment and loudspeakers at a distance from the microphone. It is not possible to avoid interference from closely mounted loudspeakers receiving the call.</p>	
<p>12.2 Microphone priority (option with requirements)</p>	<p>Plena Voice Alarm System is compliant.</p>	
<p>12.2.1 Where more than one emergency microphone can be connected to the VACIE, the emergency microphones shall be configurable for priority at access level 3 or access level 4.</p>	<p>Configuration of the emergency microphones is performed via the PC interface of the controller. This PC program requires access level 3.</p> <p>For emergency microphones 3 priority levels are available, for each possible MEG microphone location. Maximum three EMG microphone is a system: controller and maximum two remote control panels.</p>	
<p>12.2.2 Where more than one emergency microphone is configured at each priority level, only one microphone shall be active at any one time.</p>	<p>Microphones should be configured for different priorities.</p>	

13 Design requirements

Clause / Requirement	Compliance	Signature
13.1 General requirements and manufacturer's declarations	Plena Voice Alarm System is compliant.	
13.1.1 The VACIE shall comply with the design requirements of this clause, where relevant to the technology used. Some requirements can be verified by testing. Others can only be verified by inspection of the design and its accompanying documentation because of the impracticability of testing all of the possible combinations of functions and of establishing the long-term reliability of the VACIE.	See the relevant clauses regarding testing and documentation.	
13.1.2 In order to assist the process of design inspection, the manufacturer shall declare the following in writing:		
a that the design has been carried out in accordance with a quality management system which incorporates a set of rules for the design of all elements of the VACIE;	The Bosch Security Systems B.V. development department responsible for development/ maintenance of the Plena Voice Alarm System works according its own development process, Standard Development Process or SDP. Rules for the design of all elements of the Plena Voice Alarm System can be found in the TPD (document repository). In the SDP repository all process descriptions, process implementation documents, templates, guidelines, etc. of the development processes can be found.	
b that the components of the VACIE have been selected for the intended purpose and are expected to operate within their specification when the environmental conditions outside the cabinet of the VACIE comply with Class 3k5 of EN 60721-3-3:1995 + A2:1997.	The Plena Voice Alarm System was designed as a compliant voice alarm system.	
13.2 Documentation	Plena Voice Alarm System is compliant.	

Clause / Requirement		Compliance	Signature
<p>13.2.1 The manufacturer shall prepare installation and user documentation which shall be submitted to the testing authority together with the VACIE. This shall comprise at least the following:</p>		<p>The Plena Voice Alarm System Installation and User Instructions (IUI) are provided as multilingual pdf-files on www.boschsecurity.com product related information including the software for installation and configuration.</p>	
a	a general description of the equipment, including a list of	<p>The IUI contains a general description of the Plena Voice Alarm System . It includes an EN54-16 checklist, containing a list of supported optional functions. It describes all Plena Voice Alarm System functions related to EN54-16 or otherwise.</p>	
1	the optional functions with requirements of this European Standard,		
2	the functions relating to other parts of EN 54, and		
3	the ancillary functions not required by this European Standard;		
b	technical specifications of the inputs and outputs of the VACIE, sufficient to permit an assessment of the mechanical, electrical, and software compatibility with other components of the system (e.g. as described in EN 54-1), including where relevant	<p>The inputs and outputs for audio and control are described in the IUI, including the technical data, system functions, configuration instructions, compliancy to standards. This includes the information as requested in 13.2.1 b) 1)..7). The Open Interface is described in the 'Software manual of the voice alarm system.</p>	
1	the power requirements for recommended operation,	Power requirements are described in the respective manuals.	
2	the maximum number of voice alarm zones,	This is described in the respective manuals.	
3	information concerning the connection of emergency microphones,	This is described in the respective manuals.	
4	the maximum and minimum electrical ratings for each input and output,	This is described in the respective manuals.	

Clause / Requirement		Compliance	Signature
	5 information on the communication parameters employed on each transmission path,	This is described in the respective manuals.	
	6 recommended cable parameters for each transmission path, and	This is described in the respective manuals.	
	7 fuse ratings;	Main fuse ratings are described.	
c	specified means to limit the consequences of fault (see 13.5.2);	The IUI describes the following means to limit the consequences of fault: <ul style="list-style-type: none"> – Switchover to spare (standby) amplifiers – Audio/control input supervision – Backup power supply – Loudspeaker line supervision – The ability of the emergency microphone to make a ‘fail safe’ call in case of a controller defect – A/B group wiring of loudspeakers 	
d	configuring and commissioning instructions;	Configuring and commissioning instructions are included in the IUI/SCM (installation and user instruction and software configuration manual).	
e	operating instructions;	Operating instructions are included in the IUI.	
f	maintenance information.	Maintenance information of the Plena Voice Alarm System is included in the IUI.	
	13.2.2 The manufacturer shall prepare design documentation that shall be submitted to the testing authority together with the VACIE. This documentation shall include drawings, parts lists, block diagrams, circuit diagrams and a functional description to such an extent that compliance with this European Standard may be checked and that a general assessment of the mechanical and electrical design is made possible.	All of the mentioned design documentation is available as TPD for inspection by testing authorities.	

Clause / Requirement	Compliance	Signature
13.3 Mechanical design requirements	Plena Voice Alarm System is compliant.	
13.3.1 The cabinet of the VACIE shall be of robust construction consistent with the method of installation recommended in the documentation. It shall meet at least classification IP30 of EN 60529:1991+A1:2000.	The installer is responsible for implementing this requirement for 19"-units, by means of using a correct 19"- frame, meeting at least classification IP30 of EN 60529:1991+A1:2000.	
13.3.2 All interconnections and settings inside the cabinet shall be accessible at level 3.	If the installer ensures that the physical access to the Plena Voice Alarm System is restricted to access level 3, all interconnections and settings inside the cabinet (e.g. interconnections between the system elements) are accessible at this access level.	
13.3.3 The VACIE may be housed in more than one cabinet. If the documentation shows that the cabinets may be installed in locations distributed within the protected premises, then all of the mandatory manual controls and indicators shall be on one cabinet or on cabinets declared to be only suitable for mounting adjacent to each other.	The IUI shows that the Plena Voice Alarm System cabinets may be installed in locations distributed within the premises. One dedicated Plena Voice Alarm System remote control panels with extentions as needed, can then be used for all of the mandatory controls and indicators. The installer is responsible for proper installation in order to fulfill this requirement.	
13.3.4 All mandatory manual controls and light emitting indicators shall be clearly labeled to indicate their purpose. The labels shall be legible at 0.8 m distance in an ambient light intensity from 100 lux to 500 lux.	All indicators are clearly labeled. For language other than English. Permanent labels are available.	

Clause / Requirement	Compliance	Signature
<p>13.3.5 The terminations for transmission paths and the fuses shall be clearly labeled.</p>	<p>All terminations for transmission paths are clearly labeled on all of the Plena Voice Alarm System elements (near the relevant connectors).</p> <p>The mains fuse for each Plena Voice Alarm System element that has a mains connector is labeled on the rear plate of the element. The rest of the fuses are not easily accessible (only during service), therefore this requirement does not apply to them.</p>	
<p>13.4 Electrical and other design requirements</p>	<p>Plena Voice Alarm System is compliant.</p>	
<p>13.4.1 The processing of signals shall give the highest priority to the voice alarm condition.</p>	<p>Calls within the Plena Voice Alarm System have a configured priority. In case of conflicting requirements, system resources are assigned to the calls in order of priority. Voice alarm call must be configured with a high priority. All secondary functions of the system are pre-configured to stop in case calls above emergency priority are present; this includes calls below the emergency priority.</p>	
<p>13.4.2 Transitions between the main and the standby power sources shall not change any indications and/or the state of any outputs, except those relating to the power supplies.</p>	<p>Transition between the main and standby power sources does not change any of the indications and/or state of any outputs of the Plena Voice Alarm System, except for the fault warning indication (global and individual) in order to report the failure of a power source.</p>	
<p>13.4.3 If the VACIE has provision for disconnecting or adjusting the main or the standby power source, this shall only be possible at access level 3 or 4.</p>	<p>The Plena Voice Alarm System elements that have a mains and backup power supply offer connectors for the main and standby power source, a rear-mounted voltage selector switch and on/off switch. The installer is responsible to ensure that these items are only accessible at access level 3 or 4.</p>	

Clause / Requirement	Compliance	Signature
13.5 Integrity of transmission paths	Plena Voice Alarm System is compliant.	

Clause / Requirement	Compliance	Signature
<p>13.5.1 A fault in any voice alarm transmission path between the VACIE and other components of the voice alarm system shall not affect the correct functioning of the VACIE or of any other voice alarm transmission path.</p>	<p>The Plena Voice Alarm System has the following voice alarm transmission paths between itself and other parts of the voice alarm system:</p> <ul style="list-style-type: none"> – transmission path between CIE and Plena Voice Alarm System via input contact or Open Interface; – transmission path between Plena Voice Alarm System and the loudspeaker(s). <p>If there is a fault in the transmission path between the CIE and an input contact of the Plena Voice Alarm System, the configured action of the input contact will not be automatically activated or de-activated. The correct functioning of the Plena Voice Alarm System or of any other voice alarm transmission path is therefore not affected. The fault will be reported.</p> <p>If there is a fault in the transmission path between the CIE and the Ethernet connection of the controller of the Plena Voice Alarm System (connection via Open Interface), methods can no longer be invoked by the CIE and no events can be notified to the CIE. However the fault will not affect the correct functioning of the Plena Voice Alarm System or any other voice alarm transmission path. The fault will just be reported.</p> <p>If there is a fault in the transmission path between the Plena Voice Alarm System, i.e. the amplifier outputs and the loudspeaker(s), the loudspeaker(s) will not be able to produce the intended audio signal. However the fault will not affect the correct functioning of the Plena Voice</p>	

Clause / Requirement	Compliance	Signature
	Alarm System or any other voice alarm transmission path. The fault will just be reported.	
<p>13.5.2 Means shall be specified and provided to ensure that a short circuit or an interruption in the transmission path to the loudspeaker(s) does not affect more than one voice alarm zone for longer than 100 s following the occurrence of the fault.</p>	<p>Each audio output of the Plena Voice Alarm System is only assigned to one voice alarm zone by definition. The IUI specifies this clearly. Due to this, a short circuit or interruption in the transmission path to the loudspeaker(s) only affects the voice alarm zone it was assigned to.</p> <p>Multiple zones may share one amplifier channel. However, if configured correctly (line supervision switched on) the routers will perform short circuit isolation.</p>	
<p>13.5.3 Means shall be specified and provided to ensure that a single short circuit or an interruption in any voice alarm transmission path between distributed cabinets of a VACIE does not prevent the activation of a voice alarm output condition to more than one voice alarm zone for longer than 100 s following the occurrence of the fault.</p>	<p>The voice alarm transmission path between distributed cabinets of the Plena Voice Alarm System is achieved by means of the system bus.</p> <p>A single interruption or short circuit in this bus will lead to loss of functionality. To comply with this article, all Plena Voice Alarm System equipment must be housed in one 19” rack.</p>	

Clause / Requirement	Compliance	Signature
<p>13.5.4 If the VACIE is designed to be used with a power supply (item L of Figure 1 of EN 54-1) contained in a separate cabinet, then an interface shall be provided for at least two voice alarm transmission paths to the power supply, such that a short circuit or an interruption in one does not affect the other.</p>	<p>If a 19"-cabinet (rack) or adjacent cabinets provide enough space for the battery and/or charger, the installer can install the complete PSE (power supply equipment) as referred in EN54-4 in one cabinet. In that case this requirement is not applicable.</p> <p>In case the installer installs the backup part of the PSE (battery and charger) in a separate cabinet, Plena Voice Alarm System provides a separate (monitored) DC-backup connection on the Plena Voice Alarm System units. This implies that a Plena Voice Alarm System installation will always have two separate voice alarm transmission paths to the power supply: one for mains and one for DC backup. Both will not influence each other (except for current drawn). It is the responsibility of the installer to let the installation comply with this requirement.</p>	
<p>13.6 Accessibility of indications and controls</p>	<p>Plena Voice Alarm System is compliant.</p>	

Clause / Requirement	Compliance	Signature
<p>Four access levels shall be provided on the VACIE, from access level 1 (most accessible) to access level 4 (least accessible). Manual controls at a given access level shall not be accessible at a lower access level. The following shall apply:</p>	<p>The Plena Voice Alarm System offers three types of user accounts (with different access rights):</p> <ul style="list-style-type: none"> - User: user account type that offers operational control of the system; meant for operational users of the Plena Voice Alarm System; - Installer: user account type that offers operational control, configuration and diagnosis of the Plena Voice Alarm System; meant for installers and/or configurators of the Plena Voice Alarm System; - Administrator: user account type that offers full control of the system including user management, i.e. the ability to add and delete user accounts. <p>Access level 1 is intended for operational users of the Plena Voice Alarm System. It provides direct (unrestricted) operational access to the Plena Voice Alarm System via:</p> <ul style="list-style-type: none"> - Input contacts of system components; - The front panels of system components; - Remote control panels. 	
	<p>Access level 2 is intended for operational users of the Plena Voice Alarm System. Access level 2 needs to be secured by correct installation and restriction access to certain components.</p> <ul style="list-style-type: none"> - The open interface; access is restricted by restriction access to the PC. 	

	Clause / Requirement	Compliance	Signature
		<p>Access level 3 is intended for installers and/or configurators of the Plena Voice Alarm System. It provides access for configuration and diagnosis of the Plena Voice Alarm System. This level of access is offered through:</p> <ul style="list-style-type: none"> - The PC interface offered by the configuration program of the controller. A user name and password need to be provided to get access to this interface. - Physical access control by means of installing the system elements in a restricted environment, such as placing the 19"-units in a 19"-rack with key lock. This type of access can be used for physical diagnosis of the system, e.g. inspect interconnections. 	
		<p>Access level 4 is intended for maintenance personnel of the Plena Voice Alarm System. It provides software/firmware upgrade of the Plena Voice Alarm System components after logical identification. This level of access is offered through:</p> <ul style="list-style-type: none"> - The file transfer application of the Plena Voice Alarm System to transfer message sets to the controller and upgrade the system software. A password is needed to be able to use the File Transfer Application and get access to the controller. 	
a	<p>all mandatory indications shall be visible at access level 1 without prior manual intervention (e.g. the need to open a door);</p>	<p>All indicators of the Plena Voice Alarm System can be visible at access level 1. The installer is responsible for correct implementation of this requirement.</p>	

Clause / Requirement		Compliance	Signature
b	manual controls at access level 1 shall be accessible without special procedures;	Manual controls of the Plena Voice Alarm System at access level 1 are accessible without special procedures.	
c	indications and manual controls that are mandatory at access level 1 shall also be accessible at access level 2;	All Plena Voice Alarm System indications (LEDs, equipment connected to output contacts, front panel display) and manual controls (input contacts, call station keys, front panel menus) that are accessible at access level 1 will also be accessible at access level 2. It may be needed to install the equipment in a 19" rack with a glass door.	
d	entry to access level 2 shall be restricted by a special procedure;	Physical access control by means of installing the system elements in a restricted environment, such as placing (parts of the) 19"-units in a 19"-rack with key lock will be needed.	
e	entry to access level 3 shall be restricted by a special procedure, differing from that for access level 2;	Entry to access level 3 is restricted by a special procedure, see clause 13.6, access level 3 description for details. Correct configuration and installation (physical access control) will ensure that the special procedure differs from that of access level 2. The installer should ensure that the physical access procedure differs from that of the physical access procedure of access level 2, if applicable.	
f	the entry to access level 4 shall be restricted by special means which are not part of the VACIE.	Entry to access level 4 is restricted by means of having to use the File Transfer Application (FTA), see clause 13.6, access level 4 description for details. This FTA is only used for access level 4 functions and is therefore not part of the daily operation/ configuration of the Plena Voice Alarm System.	

Clause / Requirement	Compliance	Signature
<p>NOTE - Further access levels are permitted provided that they are distinct from the access levels described in this standard.</p>		
<p>13.7 Indications by means of light-emitting indicators</p>	Plena Voice Alarm System is compliant.	
<p>13.7.1 Mandatory indications from light emitting indicators shall be visible in an ambient light intensity up to 500 lux, at any angle up to 22.5° from a line through the indicator perpendicular to its mounting surface</p> <ul style="list-style-type: none"> - at 3 m distance for the general indications of functional condition, - at 3 m distance for the indication of the supply of power, and - at 0.8 m distance for other indications. 	All of the light emitting indicators of the Plena Voice Alarm System fulfill this requirement. When external light emitting indicators are installed, such as LEDs connected to fault contacts, or light emitting indicators connected to output contacts, the installer is responsible for using indicators that fulfill this requirement.	
<p>13.7.2 If flashing indications are used, both the on period and the off period shall be greater than or equal to 0.25 s, and the frequencies of flash shall not be less than</p> <ul style="list-style-type: none"> - 1 Hz for voice alarm indications, and - 0.2 Hz for fault indications. 	The fault indication does not flash; it is steady on. The voice alarm indication on the equipment flashes with a frequency of 1 Hz (on and off period of 0.5 s).	
<p>13.7.3 If the same light emitting indicators are used for the indication of specific faults and disablements, fault indications shall be flashing and disablement indications shall be steady.</p>	Disablement indication is not available in the Plena Voice Alarm System since Plena Voice Alarm System does not support the optional disablement condition.	
<p>13.8 Indications on alphanumeric displays</p>	Plena Voice Alarm System does not have an alphanumeric display.	
<p>13.8.1 If an alphanumeric display consists of elements or segments, the failure of one of these shall not affect the interpretation of the displayed information.</p>		
<p>13.8.2 If an alphanumeric display is used to display mandatory indications, it shall be clear and unambiguous.</p>		

Clause / Requirement	Compliance	Signature
<p>13.8.3 Mandatory indications on an alphanumeric display shall be legible for at least one hour following the display of a new indication of the voice alarm condition and at least 5 minutes for fault or disablement conditions, at 0,8 m distance, in ambient light intensities from 5 to 500 lux, at any angle from the normal to the plane of the display up to</p> <ul style="list-style-type: none"> - 22.5° when viewed from each side, and - 15° when viewed from above and below. 		
<p>13.9 Indication colors</p>	<p>Plena Voice Alarm System is compliant.</p>	
<p>13.9.1 The colors of the general and specific indications from light emitting indicators shall be</p>		
<p>a red for indications of voice alarms;</p>	<p>The system status LED of Plena Voice Alarm System call stations is on (red) when the system is in the voice alarm condition. The indicators on the controller and remote control panels are red. The installer is responsible for connecting a red light emitting indicator to a 'Visual EVAC indicator' output contact of the Plena Voice Alarm System. All zone indicators in emergency mode are red.</p>	

Clause / Requirement	Compliance	Signature
b yellow for indications of <ul style="list-style-type: none"> - fault warnings, and - disablements, or 	The Fault LED of Plena Voice Alarm System controller, routers and remote control panels are yellow. Additionally the call station indicator is also yellow when the system is in the fault warning condition. The installer is responsible for connecting a yellow light emitting indicator to the 'Visual fault indicator' output contact (or another output contact configured for this function). Disablement indication is not available in the Plena Voice Alarm System since Plena Voice Alarm System does not support the optional disablement condition.	
c green for the indication that the VACIE is supplied with power.	All light emitting indicators of the Plena Voice Alarm System that indicate power supply are green.	
<p>NOTE - Where voice alarm automatic message status indicators are provided, it may be advantageous to indicate the difference between evacuation and alert messages. In this case, red will be used for emergency messages and yellow may be used for alert messages.</p>		
<p>13.9.2 The use of different colors is not necessary for indications on alphanumeric displays. However, if different colors are used for different indications, the colors used shall be as specified in 13.9.1.</p>	The Plena Voice Alarm System do not use alphanumeric displays.	
<p>13.10 Audible indications</p>	Plena Voice Alarm System is compliant.	

Clause / Requirement	Compliance	Signature
<p>13.10.1 Audible indicators shall be part of the VACIE. The same device may be used for voice alarm zone activated and fault warning indications.</p>	<p>The monitor loudspeaker of the Voice Alarm System is used for both fault warning (continuous tone) and emergency condition (intermittent tone). If additional sounders are desired, the installer is responsible for connecting sounders to output contacts configured as 'EVAC indicator' or 'fault indicator'. The installer may decide to connect both the voice alarm activated output contact as well as the fault warning condition activated output contact to the same sounder.</p>	
<p>13.10.2 The minimum sound pressure level, measured under anechoic conditions at a distance of 1 m, with any access door(s) on the VACIE closed, shall be</p> <ul style="list-style-type: none"> – 60 dBA for the voice alarm condition, and – 50 dBA for the fault warning condition. 	<p>The installer is responsible for either connecting a sounder that complies with this clause outside or inside the rack, or install the system in a rack that is sufficiently acoustic transparent. Advice is to install a remote control panel, all remote control panels and the fireman's panel have a monitor speaker.</p>	
<p>13.11 Indicator testing</p>	<p>Plena Voice Alarm System is compliant.</p>	
<p>All mandatory visible and audible indicators shall be testable by a manual operation at access level 1 or 2.</p>	<p>Plena Voice Alarm System provides an 'Indicator test' button. When activated all indications the system and all its connected routers are switched on to visually check the indicators. The remote control panels have their own test button. The indicators of that remote control panel and connected extensions will light up. The installer is responsible for making indicators that are connected to control output contacts testable.</p>	
<p>13.12 Audio performance</p>	<p>Plena Voice Alarm System is compliant.</p>	
<p>13.12.1 Output power</p>		

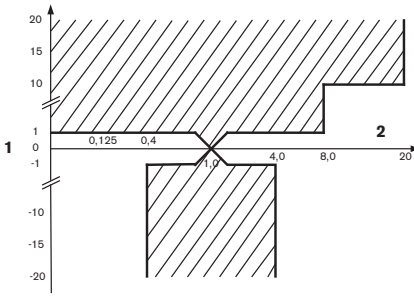
Clause / Requirement	Compliance	Signature
<p>The VACIE output power shall be as declared by the manufacturer.</p>	<p>The output power of the amplifier elements of the Plena Voice Alarm System (Power Amplifiers, Basic Amplifiers) are specified in the data sheets and in the IUI.</p>	
<p>13.12.2 Signal-to-noise ratio</p>		
<p>The VACIE shall have an A-weighted signal-to-noise ratio of at least 45 dB (see IEC 60268-1).</p>	<p>The A-weighted signal-to-noise ratio of the Plena Voice Alarm System amplifiers (Power Amplifiers and Basic Amplifiers) is specified in the data sheets and in the IUI. The signal-to-noise ratio is above 75 dB. The complete signal chain from microphone to loudspeaker is compliant to this clause.</p>	
<p>13.12.3 Frequency response</p>		
<p>The frequency response of the VACIE shall fit within the non-shaded area in Figure 1 for sound sources without microphone(s) (e.g. message store) and Figure 2 for sound sources with microphone(s).</p>		
<div style="text-align: center;">  </div> <p>VACIE frequency response limits without microphone(s)</p> <p>Key</p>	<p>The frequency response of all Plena Voice Alarm System sound paths that do not include microphones is within the specified limits of this clause.</p>	
<p>1</p>	<p>relative output signal level, with reference to 0 dB signal level measured at 1 kHz (dB)</p>	
<p>2</p>	<p>1/3 octave frequency band (Hz)</p>	

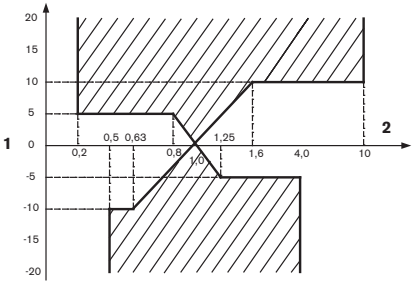
Clause / Requirement	Compliance	Signature
 <p>VACIE frequency response limits with microphone(s)</p> <p>Key</p>	<p>The frequency response of all Plena Voice Alarm System sound paths that include microphones is within the specified limits of this clause.</p>	
1	relative output signal level, with reference to 0 dB signal level measured at 1 kHz (dB)	
2	1/3 octave frequency band (Hz)	
<p>NOTE - The frequency response limits exclude loudspeakers.</p>		
<p>NOTE - A bandwidth of 400 Hz to 4 kHz is sufficient to achieve acceptable intelligibility in some acoustic environments. However, a higher frequency limit may be necessary to achieve acceptable intelligibility in more difficult acoustic environments due, for example, to the masking effect caused by reverberation and/or ambient noise.</p>		
<p>13.13 Message store(s)</p>		
<p>Pre-recorded messages shall be stored in non-volatile memory that retains the messages when all power sources are removed.</p>	<p>Plena Voice Alarm System is compliant.</p> <p>The pre-recorded messages of the Plena Voice Alarm System are digitally stored on a Flash memory in uncompressed format (linear PCM, 16-bit, 44.1kHz). This card retains the messages when all power sources are removed.</p>	
<p>NOTE - The use of tapes or magnetic or optical data disks for the storage of emergency messages is not acceptable at the time of drafting this European Standard (see Annex C)</p>		
<p>13.14 Redundant power amplifiers (option with requirements)</p>		
	<p>Plena Voice Alarm System is compliant.</p>	

Clause / Requirement	Compliance	Signature
<p>13.14.1 The VACIE may have provision for at least one spare power amplifier. In this case:</p>	<p>The Plena Voice Alarm System has a minimum of one main amplifier and one call amplifier. It has a maximum of one main amplifier per router and one spare amplifier per router (including the router built in the controller). Each router of the Plena Voice Alarm System has an input for connecting a spare amplifier channel. It also contains switch-over relays to switch the loudspeaker load from the original amplifier output to the spare amplifier output. A spare amplifier channel assignment is configurable to multiple routers (in single channel mode).</p>	
<p>a in the event of the failure of a power amplifier, the faulty amplifier shall be capable of being replaced automatically with a spare amplifier within 10 s of the fault being detected;</p>	<p>After fault detection of an amplifier all loudspeaker lines are switched automatically to the spare amplifier (if connected and configured) within 10 s.</p>	
<p>NOTE - This can be achieved, for example, by switching or by permanently connected parallel amplifiers.</p>		
<p>b the spare power amplifier(s) shall have at least the same functionality and output power as the replaced amplifier.</p>	<p>Each router of the Plena Voice Alarm System has a spare amplifier input. The installer is responsible for proper installation and configuration of the amplifiers to match amplifier power and load. Plena Voice Alarm System takes care of input signal switching to the spare amplifier channel. This way the spare power amplifier(s) will have the same functionality and output power as the replaced amplifier.</p>	

Clause / Requirement	Compliance	Signature
13.14.2 Every fault of an amplifier shall be indicated by a general fault warning indicator as specified in .2	All Plena Voice Alarm System power amplifiers are supervised for overload, overheating, short-circuit, ground short and amplifier defect. If any such fault is detected it is indicated both by means of the general fault warning indicator and by means of an individual fault LED.	
13.14.3 Supervision of the spare amplifier(s) shall be maintained during the functional condition whilst the VACIE is powered by either the mains or standby power supplies.	The spare amplifiers are continuously supervised, supervision is identical to the main (call) amplifier. The supervision is active whilst the Plena Voice Alarm System is powered by either the mains or standby power supplies. Note: the spare amplifiers in the Voice Alarm System are used as background music amplifiers (if so configured).	

14 Additional design requirements for software controlled VACIE

Clause / Requirement	Compliance	Signature
14.1 General requirements and manufacturer's declarations	Plena Voice Alarm System is compliant.	
In order to fulfill requirements of this European Standard the VACIE may contain elements which are controlled by software. In this case, the VACIE shall comply with the requirements of Clause 13 Design requirements and this clause where relevant to the technology used.	The Plena Voice Alarm System is centrally controlled by the software running on the controller.	
14.2 Software documentation	Plena Voice Alarm System is compliant.	
14.2.1 The manufacturer shall prepare documentation that gives an overview of the software design, which shall be submitted to the testing authority together with the VACIE. This documentation shall be in sufficient detail for the design to be inspected for compliance with this European Standard and shall comprise at least the following:	The software design documentation is available for testing authorities. It is in sufficient detail for the design to be inspected for compliance.	

Clause / Requirement		Compliance	Signature
a	functional description, using a clear methodology appropriate to the nature of the software, e.g. graphical representations of the system design, data flows and control flows and of the main program flow, including:	Software design documents are available and maintained.	
	1 a brief description of each module and the tasks it performs,	Architecture documents are available.	
	2 the way in which the modules interact,	Architecture and design documents are available.	
	3 the way in which the modules are called, including any interrupt processing, and	Architecture and design documents are available.	
	4 the overall hierarchy of the program;	Architecture documents are available.	
b	a description of which areas of memory are used for the various purposes (e.g. the program, site specific data and running data);	Memory usage is described in the system architecture document.	
c	a description of how the software interacts with the hardware of the VACIE.	Hardware software interaction is described in a set of Hardware-Software Interface documentation.	
Where dynamic memory management is employed, a separation shall be implemented between the program, site specific data and running data and this shall be described in connection with the method of memory allocation.		The program is located in separate Flash EPROMs that are reserved for the program executable. The message data is stored on a separate Flash EPROMs.	
14.2.2 The manufacturer shall prepare and maintain detailed design documentation. This need not be submitted to the testing authority but shall be available for inspection in a manner which respects the manufacturer's rights of confidentiality. This documentation shall comprise at least the following:		The software design documents contain detailed design documentation. Furthermore code comments also contain detailed design documentation.	
a	a description of each module of the program, as it is implemented in the source code of the program, containing: <ul style="list-style-type: none"> – the name of the module, and – the identification of the author(s); 	The Plena Voice Alarm System software component descriptions (module descriptions) are available from the software architecture documents. These documents contain the names of the components.	

Clause / Requirement		Compliance	Signature
b	the source code listing, including all global and local variables, constants and labels used, and sufficient comment for the program flow to be recognized;	The source code can be obtained.	
c	details of any software tools used in the preparation of the program (e.g. high level design tools, compilers, assemblers).	The list can be composed on request and contains high level design tools, compilers for various processors, syntax validation tools, build tools, test tools, performance validation tools, version control tools, and defect tracking tools.	
14.3 Software design		Plena Voice Alarm System is compliant.	
In order to ensure the reliability of the VACIE the following requirements for software design shall apply:			
a	the software shall have a modular structure;	The modular structure of the Plena Voice Alarm System software is documented in the software architecture documents.	
b	the design of the interfaces for manually and automatically generated data shall not permit invalid data to cause an error in the program execution;	The interfaces between the modules and to external components are well defined and described in the design documents and external interface documents (Open Interface). Asserts are used to validate inputs on component boundaries.	
c	the software shall be designed to avoid the occurrence of a deadlock in the program flow.	Design guidelines are in place to avoid deadlocks. Multi threading within components is avoided where feasible and components have an input command queue for safe decoupling of threads.	
14.4 Program monitoring (see also Annex C)		Plena Voice Alarm System is compliant.	
14.4.1 The execution of the program shall be monitored as under 14.4.2 or 14.4.3. If routines associated with the main functions of the program are no longer executed, either or both of the following shall apply:			

Clause / Requirement		Compliance	Signature
a	the VACIE shall indicate a system fault (as in 8.3);	Upon activation of a watchdog, a fault is reported after restart of the failing component indicating the failing unit and processor. A system fault is indicated when entering the fault condition.	
b	the VACIE shall enter the fault warning condition and indicate faults of affected supervised functions (as in 8.2.4, 8.2.5, 8.2.6 and 8.3), where only these functions are affected.	Upon activation of a watchdog, a fault is reported after restart of the failing component indicating the failing unit and processor.	
14.4.2 If the program executes in one processor, the execution of the routines in 14.4.1, it shall be monitored by a monitoring device as in 14.4.4.		All processors used in the Plena Voice Alarm System are either guarded by a hardware watchdog or are monitored by a processor that is guarded by a hardware watchdog.	
14.4.3 If the program executes in more than one processor, the execution of the routines in 14.4.1 shall be monitored in each processor. A monitoring device as in 14.4.4 shall be associated with one or more processors, and at least one such processor shall monitor the functioning of any processor not associated with such a monitoring device.		All processors are either guarded by a hardware watchdog or are monitored by a processor that is guarded by a hardware watchdog. The controller is responsible for monitoring all processors in the system. Upon failure of one of the processors, either due to a watchdog failure or due to a communication failure a fault is generated. Failure of the controller itself will cause the system fault output contact to be de-energized to indicate a system fault.	
14.4.4 The monitoring device of 14.4.2 and 14.4.3 shall have a time-base independent of that of the monitored system. The functioning of the monitoring device, and the signaling of a fault warning, shall not be prevented by a failure in the execution of the program of the monitored system.		All processors are either guarded by a hardware watchdog or are monitored by a processor that is guarded by a hardware watchdog. Additionally the correct operation of the main processor of all system elements is validated by adding execution checks on relevant locations in the code. This to assure that no important flow is excluded from execution.	

Clause / Requirement	Compliance	Signature
<p>14.4.5 In the event of a system fault as specified in 14.4.1 a) or 14.6, those parts of the VACIE affected shall enter a safe state not later than the indication of the system fault. This safe state shall not result in the false activation of mandatory outputs.</p>	<p>Upon restart of a unit other than the Controller, the unit will be reinitialized and reordered to its expected state.</p>	
<p>14.5 The storage of programs and data (see also Annex C)</p>	<p>Plena Voice Alarm System is compliant.</p>	
<p>14.5.1 All executable code and data necessary to comply with this European Standard shall be held in memory that is capable of continuous, unmaintained, reliable operation for a period of at least 10 years.</p>	<p>All Plena Voice Alarm System programs (executable code and data) are stored in Flash EEPROM.</p>	
<p>14.5.2 For the program, the following requirements shall apply:</p>		
<p>a the program shall be held in non-volatile memory, which can only be written to at access level 4, and</p>	<p>Firmware (i.e. the program) can be replaced using the File Transfer Application. Using the File Transfer Application requires access level 4.</p>	
<p>b it shall be possible to identify the version reference or references of the program at access level 3. The version reference or references shall be in accordance with the documentation of 13.2.1.</p>	<p>The version of the firmware of the units is visible on the units It is noted on the rear of the unit (access level 3).</p>	
<p>14.5.3 For site-specific data, including emergency message(s), the following requirements shall apply:</p>		
<p>a the alteration of site specific data shall only be possible at access level 3 or 4;</p>	<p>Alteration of configuration can only be done via the configuration program or access to the units from the rear. This includes the File Transfer Application (message sets). Getting access to the configuration of the controller requires access level 3. Using the File Transfer Application requires access level 4.</p>	

Clause / Requirement		Compliance	Signature
b	the alteration of site specific data shall not affect the structure of the program;	Configuration of the Plena Voice Alarm System is implemented to be data-driven and is not part of the program executable. Also transferring message sets to the Plena Voice Alarm System is data-driven and is not part of the program executable. Therefore alteration of the site specific data does not affect the structure of the program.	
c	if stored in read-write memory, there shall be a mechanism which prevents the memory being written to during normal operation at access level 1 or 2, such that its contents are protected during a failure in program execution;	Site specific data is stored in a Flash EEPROM based file system. Writing of data is only possible via the password protected PC program.	
d	It shall be possible to either read or interrogate the site specific data at access level 2 or 3, or the site specific data shall be given a version reference that shall be updated when each set of alterations is carried out.	Site specific data can be viewed and maintained from the configuration (PC) program. Using the configuration (PC) program requires access level 3.	
e	If the site specific data has a version reference, it shall be possible to identify this at access level 2 or 3.	The site specific data of the Plena Voice Alarm System does not have a version reference.	
14.6 Monitoring of memory contents		Plena Voice Alarm System is compliant.	
The contents of the memories containing the site specific data shall be automatically checked at intervals not exceeding 1 h. The checking device shall signal a system fault if a corruption of the memory contents is detected.		The message store is checked every 100 s using checksum validation. Upon detecting corruption, a fault is reported indicating a corrupt message store.	

15 Marking

Clause / Requirement		Compliance	Signature
		Plena Voice Alarm System is compliant.	
The VACIE shall be marked with the following information, which shall be legible at access level 1:			

Clause / Requirement		Compliance	Signature
a	the number of this European Standard;	Marking the Plena Voice Alarm System with the number of this European standard (which is legible at access level 1) is the responsibility of the installer, since the installer will have to install and configure the system properly in order to let the installation comply with this standard.	
b	the name or trademark of the manufacturer or supplier;	The name 'Bosch' is visible on each element of the Plena Voice Alarm System. It is the responsibility of the installer to ensure that this name is legible at access level 1 for all system elements.	
c	the type number or other designation of the VACIE.	The type number of each unit of the Plena Voice Alarm System is present on the unit itself. The installer is responsible for ensuring that this type number is legible at access level 1.	
It shall be possible to identify a code or number that identifies the production period of the VACIE at access level 1 or 2 or 3.		The hardware version and production data are visible on the type number plate of each unit of the Plena Voice Alarm System. The installer is responsible for ensuring that this type number plate is identifiable at access level 1, 2 or 3.	
Where Annex ZA.3 covers the same requirements as this clause, the requirements of this clause are met.			

16 Tests

Clause / Requirement	Compliance	Signature
	Test have been carried out during certification of the Plena Voice Alarm System.	

Bosch Security Systems B.V.

Torenallee 49

5617 BA Eindhoven

The Netherlands

www.boschsecurity.com

© Bosch Security Systems B.V., 2013