

3•2•1 GSX

DVD HOME ENTERTAINMENT SYSTEM

Owner's Guide



SAFETY INFORMATION

Please read this owner's guide

Please take the time to follow this owner's guide carefully. It will help you set up and operate your system properly, and enjoy all of its advanced features. Save your owner's guide for future reference.

- WARNING:** To reduce the risk of fire or electric shock, do not expose the system to rain or moisture.
- WARNING:** This apparatus shall not be exposed to dripping or splashing, and objects filled with liquids, such as vases, shall not be placed on the apparatus. As with any electronic products, use care not to spill liquids in any part of the system. Liquids can cause a failure and/or a fire hazard.

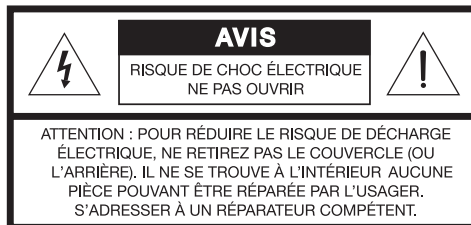
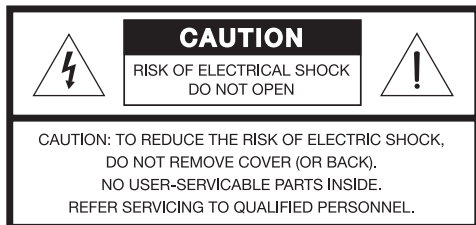

The CAUTION marks shown here are located on the bottom of your 3•2•1 GSX home entertainment system media center and the rear panel of the Acoustimass® module:



The lightning flash with arrowhead symbol within an equilateral triangle alerts the user to the presence of uninsulated, dangerous voltage within the system enclosure that may be of sufficient magnitude to constitute a risk of electric shock.



The exclamation point within an equilateral triangle alerts the user to the presence of important operating and maintenance instructions in this owner's guide.

- CAUTION:** To prevent electric shock, match wide blade of plug to wide slot, insert fully.
- CAUTION:** No naked flame sources, such as lighted candles, should be placed on the apparatus.

Class 1 laser product

This CD player is classified as a CLASS 1 LASER PRODUCT according to EN 60825-1:1994+A1+A2, IEC60825-1:1993+A1+A2.

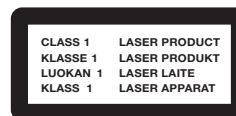

- CAUTION:** Use of controls or adjustments or performance of procedures other than those specified herein may result in hazardous radiation exposure. The DVD player should not be adjusted or repaired by anyone except properly qualified service personnel.

Class B emissions limits

This Class B digital apparatus meets all requirements of the Canadian Interference-Causing Equipment Regulations.



Batteries

Please dispose of used batteries properly, following any local regulations. Do not incinerate.

- CE** This product conforms to the EMC Directive 89/336/EEC and to the Low Voltage Directive 73/23/EEC. The complete Declaration of Conformity can be found at www.bose.com.

Additional safety information

See the additional instructions on the *Important Safety Information* sheet enclosed in the shipping carton.

©2005 Bose Corporation. No part of this work may be reproduced, modified, distributed, or otherwise used without prior written permission.

The distinctive design of the 3•2•1 media center is also a registered trademark of Bose Corporation.

Manufactured under license from Dolby Laboratories. "Dolby" and the double-D symbol are trademarks of Dolby Laboratories. Confidential Unpublished Works. ©1992-1997 Dolby Laboratories. All rights reserved.

This product contains one or more programs protected under international and U.S. copyright laws as unpublished works. They are confidential and proprietary to Dolby Laboratories. Their reproduction or disclosure, in whole or in part, or the production of derivative works therefrom without the express permission of Dolby Laboratories is prohibited. ©1992-1996 by Dolby Laboratories, Inc. All rights reserved.

MPEG Layer-3 audio compression technology licensed by Fraunhofer IIS and THOMSON multimedia.

"DTS" and "DTS Digital Surround" are registered trademarks of Digital Theater Systems, Inc.

CONTENTS

INTRODUCTION	5
SYSTEM SETUP	8
SYSTEM CONTROLS AND INDICATORS	26
OPERATION	35
CHANGING SOURCE SETTINGS	48
CHANGING SYSTEM OPTIONS	53
MAINTAINING YOUR SYSTEM	64
TROUBLESHOOTING	66

INTRODUCTION	5
Before you begin	5
System features	5
Introducing the uMusic® intelligent playback system	5
Checking for region code compatibility	5
Selecting compatible discs	6
Glossary of terms	6
Limited warranty	7

SYSTEM SETUP	8
Unpacking	8
Selecting locations for your 3•2•1 GSX system components	9
Positioning the media center	9
Positioning the speakers	10
Positioning the Acoustimass® module	11
Making system connections	12
Connecting the Acoustimass module to the media center	12
Connecting the speakers to the Acoustimass module	12
Connecting the supplied antennas	14
Connecting cable FM radio	14
Connecting your TV to the media center	15
Making audio connections	15
Making composite video connections	15
Connecting your TV and VCR to the media center	16
Option A: TV (with audio output jacks) + VCR + media center	16
Option B: TV (NO audio output jacks) + VCR + media center	17
VCR considerations	18
Advanced setup options	18
Making S-video connections (higher quality video)	18
Making component video connections (highest quality video)	19
Connecting digital audio devices	20
Connecting your cable/satellite box, TV, and VCR to the media center	20
Connecting a game console	22
Installing the remote control batteries	23
Connecting the power cord	24
Verifying your system setup	25

SYSTEM CONTROLS AND INDICATORS	26
Remote control	26
Setting up your remote to control other audio/video devices	30
Direct entry of a device code	30
Searching for a device code	31
Verifying an entered device code	33
Changing channel selection control	33
Media center	34

OPERATION	35
Turning your system on and off	35
Playing video DVDs	35
Basic DVD operations	36
Restricting access to video DVDs	36
Playing audio CDs	37
Listening to FM/AM radio	38
Tuning to a station	38
Storing stations as presets	38
Erasing a preset	38
Using the uMusic® intelligent playback system	39
Storing CDs	39
Playing stored music	40
Rating your music	42
Stored music play modes	42
Repeat and shuffle functions	42
Deleting stored tracks	43
Using uMusic® presets	43
Using the Playlist	45
Searching through your music library	46
Registering your system for music information updates	47
CHANGING SOURCE SETTINGS	48
Using the settings menus	48
Stored CD settings menu	50
FM/AM settings menu	50
CD settings menu	50
DVD settings menu	51
TV, CBL-SAT, and AUX settings menu	52
CHANGING SYSTEM OPTIONS	53
Using the System menu	53
Stored CD options	54
Audio options	58
Video options	59
Media center options	60
Remote control options	61
DVD Lock options	62
MAINTAINING YOUR SYSTEM	64
Cleaning	64
Replacing the remote control batteries	65
Accessories	65
TROUBLESHOOTING	66
Troubleshooting table	66
Customer service	67
TECHNICAL INFORMATION	68
END USER LICENSE AGREEMENT	69
DEVICE CODES	A-1

Before you begin

Thank you for purchasing the 3•2•1 GSX DVD home entertainment system, which offers superb sound, elegance, and simplicity in an advanced home audio setup. Using Bose® proprietary signal processing technology, the 3•2•1 GSX system provides improved spaciousness from stereo recordings, and bold movie effects from surround-encoded materials. Yet its few parts require little effort to set up, so you can enjoy your new system's performance right away.

The following items are included to help you set up your system:

- Quick Setup Guide
- Detailed setup instructions in Setup section of this guide
- Setup DVD

System features

- Integrated AM/FM tuner and DVD/CD player in a small media center
- uMusic® intelligent playback system for storing and playing your favorite songs
- Small, easy-to-place shelf speakers and an attractive hideaway Acoustimass® module
- Easy-to-use universal infrared remote control
- Media center input jacks for a TV, cable/satellite box, or other component such as a DVR

Introducing the uMusic® intelligent playback system

Your 3•2•1 GSX DVD home entertainment system includes the new uMusic intelligent playback system – a breakthrough Bose technology that makes it possible to store and enjoy your CD collection.

What can you do with this system?

- Store your favorite CDs in a music library. Your system can store approximately 200 hours of music or about 200 CDs.
- Teach the system which tracks your like or dislike, conditioning the system to automatically play the music you want to hear most.
- Discover many ways to enjoy your music.

Checking for region code compatibility



For a DVD player and DVD disc to be compatible, their region code numbers must match. These numbers are allocated according to where the player and disc are sold. The 3•2•1 GSX DVD home entertainment systems have a region code that must also match the DVD discs.

Check the region code number on the carton of the 3•2•1 GSX DVD home entertainment system or on the bottom of the media center that comes in the carton. Then be sure to choose only DVD discs that show the same region number on the disc label or front cover.

For example, a Region 1 DVD disc should display the following mark: 

Selecting compatible discs

The DVD/CD player built into the 3•2•1 GSX media center can play the following types of discs identified by their corresponding logos:

- Video DVD 
- Video CD 
- DVD+R, DVD-R, DVD+RW, and DVD-RW
- Audio CD 
- CD-R and CD-R/W
- MP3 CDs, where
 - All tracks were burned in a single closed session
 - The disc format is ISO9660
 - Each file has a “.mp3” extension and the filename contains no other periods
- SACDs (CD-compatible content only)

 **Note:** *Regarding copy protection – Music and other content may be protected by international and domestic copyright laws and may contain specific restrictions on use and/or reproduction. Please respect the rights of the artists and other copyright holders.*

Glossary of terms

Aspect Ratio – The shape of the rectangular picture in a TV set. It is the width of the picture relative to the height. Our standard TV picture, in terminology used by that industry, is 4 units wide by 3 units high, or 4:3 (read as 4 by 3) in aspect ratio. There are currently two standard TV aspect ratios, 4:3 and 16:9.

Chapter – In DVD-Video, a division of a title.

Component Video – A video signal split into three parts: luminance and two color signals (marked as YPbPr). It provides the highest level of video quality.

Composite Video – A single video signal that contains luminance, color, and synchronization information. NTSC and PAL are examples of composite video systems.

Dolby Laboratories – Developer of a perceptual coding system for audio.

Dolby Digital  – A type of multi-channel surround sound format used on discs.

DTS  – A type of multi-channel surround sound format used on discs.

DVD – An acronym that is most commonly known to mean Digital Video Disc or Digital Versatile Disc. The audio/video/data storage system based on 12- and 8-cm optical discs.

DVD Video – A standard for storing and reproducing audio and video on DVD-ROM discs, based on MPEG video, Dolby Digital and MPEG audio, and other proprietary data formats.

This product incorporates copyright protection technology that is protected by method claims of certain U.S. patents and other intellectual property rights owned by Macrovision Corporation and other rights owners. Use of this copyright protection technology must be authorized by Macrovision Corporation, and is intended for home and other limited viewing uses only unless otherwise authorized by Macrovision Corporation. Reverse engineering or disassembly is prohibited.

Consumers should note that not all high definition television sets are fully compatible with this product and may cause artifacts to be displayed in the picture. In case of 525 or 625 progressive scan picture problems, it is recommended that the user switch the connection to the “standard definition” output. If there are questions regarding our TV set compatibility with this model 525p and 625p DVD player, please contact our customer service center.

Designed with UEI Technology™ Under License from Universal Electronics Inc. © UEI 2000-2002.

Gracenote – Music recognition technology and related data provided as part of the service contracted by Bose.

IR – An acronym for infrared. Pertains to the type of remote that sends/receives commands on an infrared light beam.

MPEG – A type of data compression used for audio or video storage on disc.

MP3 – MPEG-1 Layer III audio. This is a compressed audio format that allows you to record many hours of music on a single CD.

NTSC – An acronym for National Television System Committee. The organization that developed both the American Black & White and Color television systems.

PAL – An acronym for Phase Alternate Line. A television format used extensively in Western Europe.

Progressive Scan – A video format that displays all lines of the picture frame in a single pass, and refreshes the TV image 30x/sec. Not compatible with all video displays.

PVR – An abbreviation for Personal Video Recording. Sometimes used interchangeably with DVR for Digital Video Recording, but may include non-digital technology, as used in VCRs.

RDS – A system that displays radio broadcast station and programming information. This feature is available on European systems only.

SACD – An abbreviation for Super Audio Compact Disc, used for high-resolution digital audio storage on CD-sized discs. New Bose® 3•2•1 GSX systems play the CD-compatible portion of such discs, identified by the CD disc logo on the front of the disc.

S-video – A video interface standard that carries separate luminance and chrominance signals, usually on a four-pin mini-DIN connector. Also called Y/C. The quality of S-video is significantly better than composite video since it does not require a comb filter to separate the signals. Most high-end televisions have S-video inputs.

uMusic® intelligent playback system – A revolutionary Bose play mode, which performs like a virtual DJ by noting listener preferences and playing suitable stored CD tracks in response.

Videostage® 5 – Bose proprietary Videostage 5 decoding circuitry gives you a five-channel surround sound experience from everything you listen to – VHS tapes, stereo CDs, even mono TV programs.

Limited warranty

Your 3•2•1 GSX DVD home entertainment system is covered by a limited transferable warranty. Details of the limited warranty are provided on the product registration card that came with your system. Please fill out the information section on the card and mail it to Bose. Failure to do so will not affect your limited warranty rights.

This product incorporates copyright protected technology and other intellectual property rights owned by Cirrus Logic, Inc. and subject to the copyright protection of the U.S. as well as other licensing restrictions and protections. Use of this copyright protected technology is limited solely to use with the Cirrus Logic integrated circuits incorporated in this product. Reverse engineering or disassembly is prohibited.

Music recognition technology and related data are provided by Gracenote® and the Gracenote CDDB® music recognition service. Gracenote is the industry standard in music recognition technology and related content delivery. For more information visit www.gracenote.com.



CD and music-related data from Gracenote, Inc., ©2000-2003 Gracenote. Gracenote CDDB® Client Software, copyright 2000-2003 Gracenote. This product and service may practice one or more of the following U.S. Patents #5,987,525; #6,061,680; #6,154,773; #6,161,132; #6,230,192; #6,230,207; #6,240,459; #6,330,593, and other patents issue or pending.

Gracenote and CDDB are registered trademarks of Gracenote. The Gracenote logo and logotype, the Gracenote logo, CDDB logo and logotype and the "Powered by Gracenote" logo are trademarks of Gracenote.



Data provided by All Music Guide ©2004 AEC One Stop Group, Inc. All Music Guide is a registered Trademark of AEC One Stop Group, Inc.

SYSTEM SETUP

Unpacking

SYSTEM SETUP

Carefully unpack your system. Save all packing materials, which provide the safest way to transport your system. Check to be sure your system includes the parts shown in Figure 1.

If any part of the system appears damaged, do not attempt to use it. Notify Bose or your authorized Bose® dealer immediately. For Bose contact information, refer to the address sheet included in the carton.

WARNING: To avoid danger of suffocation, keep the plastic bags out of the reach of children.

Figure 1

Contents of the shipping carton

Your system includes one of the following cords:



120 VAC power cord (U.S./Canada)



115/230 VAC power cord with adapter (U.S./Europe)



230 VAC power cord (Europe)



230 VAC power cord (U.K./Singapore)



240 VAC power cord (Australia)

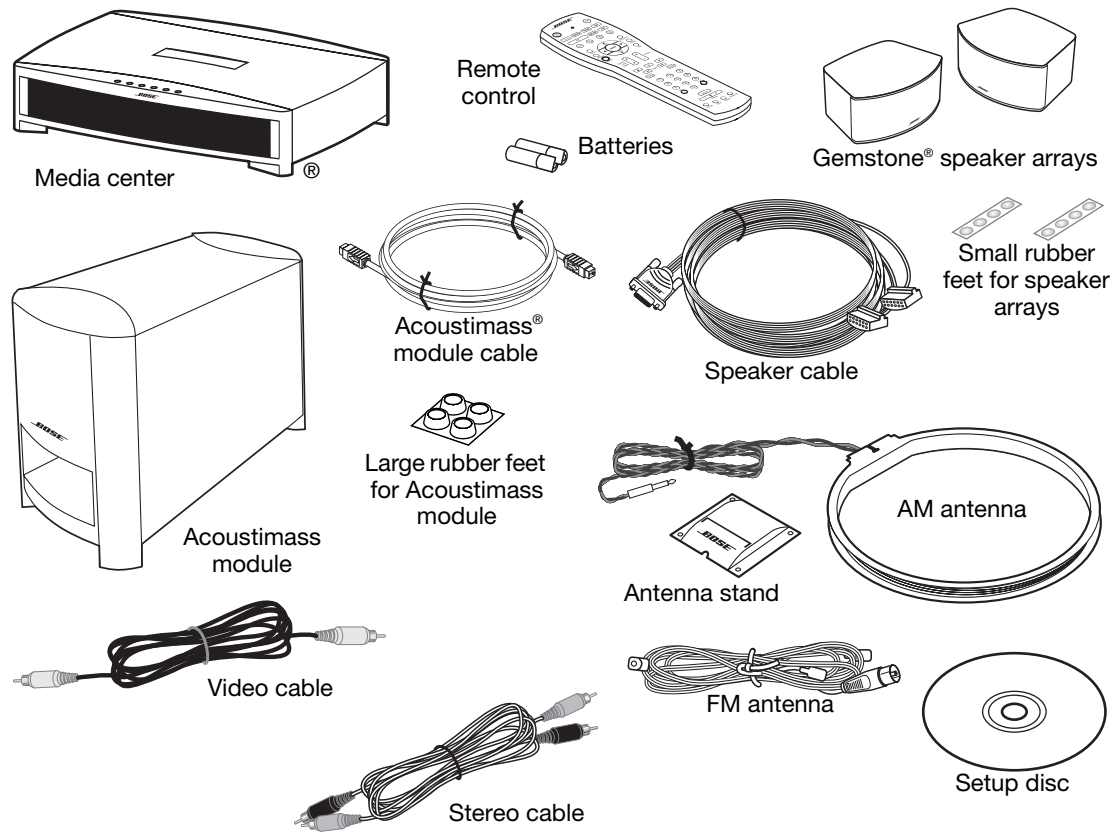

For your records

Now is a good time to find the serial numbers on the bottom of the media center and on the rear of the Acoustimass module. Please record them here and on your product registration card. You will need to have them ready if you ever need to contact Bose Customer Service.

Media center serial number: _____

Acoustimass module serial number: _____

Dealer name: _____

Dealer phone: _____ Purchase date: _____

We suggest you keep your sales receipt and product registration together with this owner's guide.

Selecting locations for your 3•2•1 GSX system components

Use the following guidelines and Figure 2 to choose locations and positions for the components of your 3•2•1 GSX home entertainment system.

🎵 **Note:** While these guidelines are offered to help provide great system performance, you may find other placement choices that are more convenient and provide the sound you enjoy.

Positioning the media center

⚠️ **CAUTION:** Do not block any ventilation openings. For reliable operation of the product and to protect it from overheating, put the product in a position and location that will not interfere with its proper ventilation. For example, do not place the product on a bed, sofa, or similar surface that may block the ventilation openings. Do not put it in a built-in system, such as a bookcase or cabinet, that may keep air from flowing through its ventilation openings.

- Place the media center where nothing obstructs opening the disc tray on its front panel.
- Position the media center close enough to the Acoustimass® module and the speakers so that all the cables will reach.
- Make sure the media center is close enough to additional source devices (TV, VCR, or cable box) so that all the cables will reach.
- Make sure that the front of the media center is unobstructed so that it may receive IR (infrared) commands from the remote control.

Figure 2

Sample media center and speaker placement

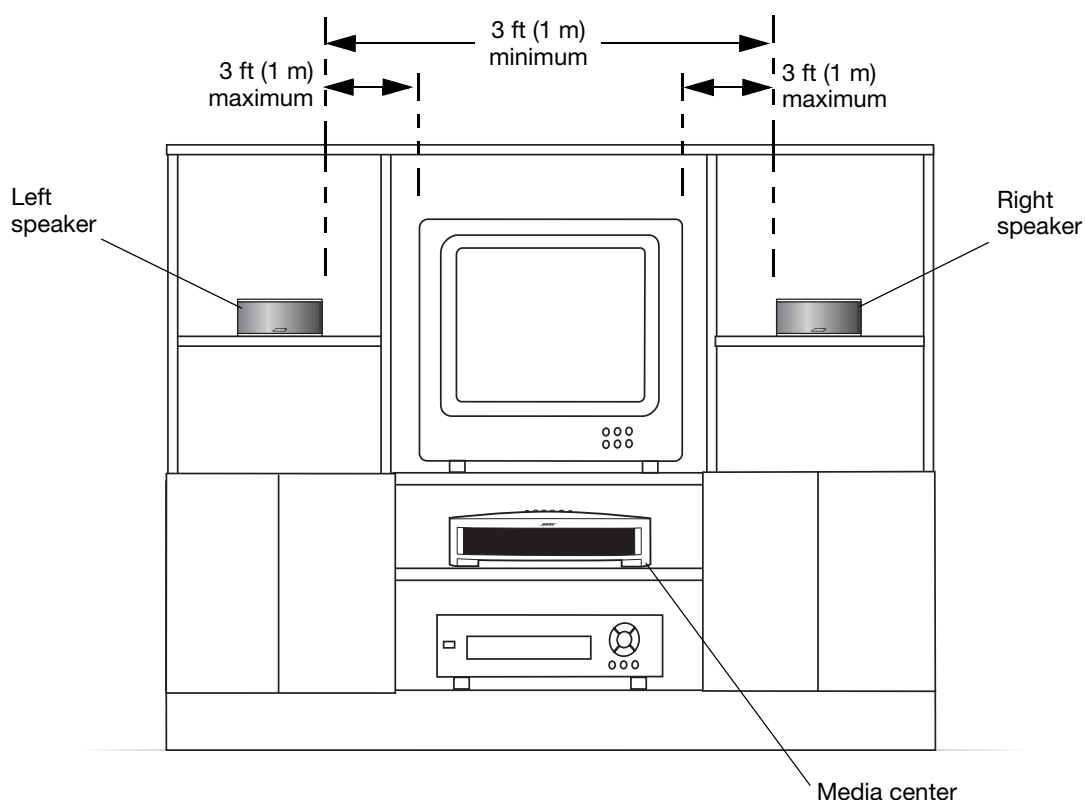

🎵 **Note:** The left and right speakers are magnetically shielded to prevent interference with your TV screen.

Positioning the speakers

Choosing a good location for the speakers will allow you to experience the audio surround effects that your 3•2•1 GSX home entertainment system is designed to deliver.

- Place the left and right speakers at least **3 feet (1 meter) apart from each other** to optimize the surround sound experience (Figure 3).
- Place each speaker **within 3 feet (1 meter) of the edge of the TV screen**. Placing the speakers more than 3 feet away from the TV can cause the sound to become separated from the picture.
- If you are using a bookshelf or a home entertainment unit, place each speaker at the **front edge** of its shelf. Positioning the speakers too far back in an enclosed space can change the overall quality of sound and alter the movie sound effects.

⚠ CAUTION: Choose a stable and level surface for both speakers. Vibration can cause the speakers to move, particularly on smooth surfaces like marble, glass, or highly polished wood. If you are placing the speakers on a flat surface, be sure to attach one set of the small rubber feet to the bottom surface of each speaker. You can obtain additional rubber feet (PN 178321) from Bose® Customer Service. To contact Bose, refer to the list of offices included in the product carton.

🎵 Note: The speakers can be mounted on Bose brackets, table stands, or floor stands. For ordering information, refer to "Accessories" on page 66. Additional or longer cables may also be ordered.

- Set the speakers on their bottom surfaces, only, with the Bose logo right-side up.



- Aim the speakers straight ahead into the listening area. Do not place the speakers at an angle. **Angling one or both speakers into or away from the listening area significantly alters system performance.**

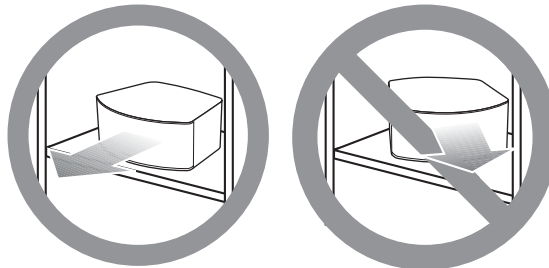

Figure 3

Recommended speaker placement

Positioning the Acoustimass® module

- Place the module at the same end of the room as the TV and the speakers (Figure 4).
- Keep the module at least **3 feet (1 meter)** away from the TV to prevent the module from interfering with the TV screen.
- Place the Acoustimass® module within reach of the cable from the music center and an AC (mains) power outlet.
- Choose a convenient location, such as under a table, behind a sofa or chair, or behind drapes, but do not block the port opening.

Figure 4

Recommended
Acoustimass module
placement

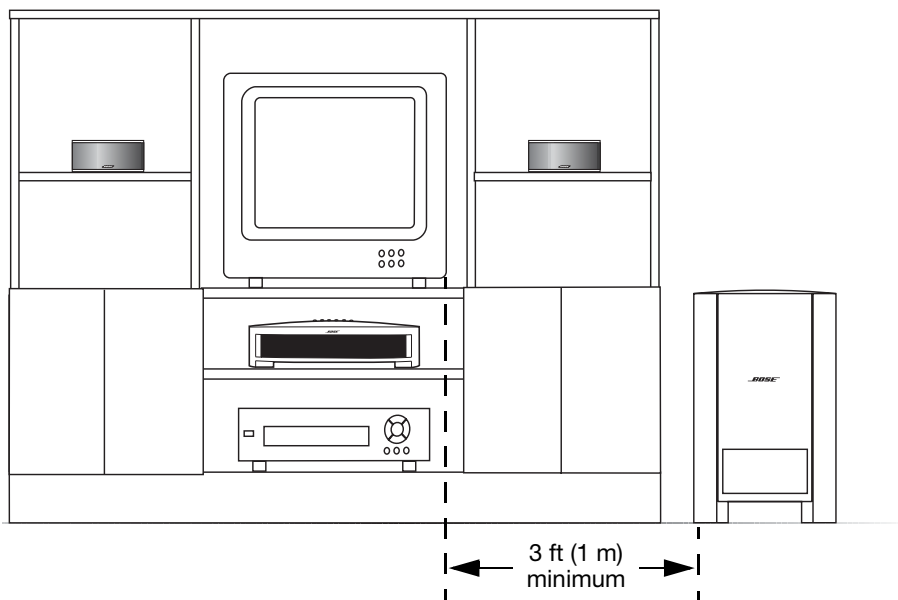

- Attach the large rubber feet to the bottom of each foot on the module. The rubber feet provide increased stability and protection from scratches.
- Aim the port of the module into the room or along the wall. This prevents a blocked port or over-powering bass.
- Stand the Acoustimass module on its feet. Do not lay it on its side or stand it on either end (Figure 5).

Figure 5

Recommended orientation
of the module

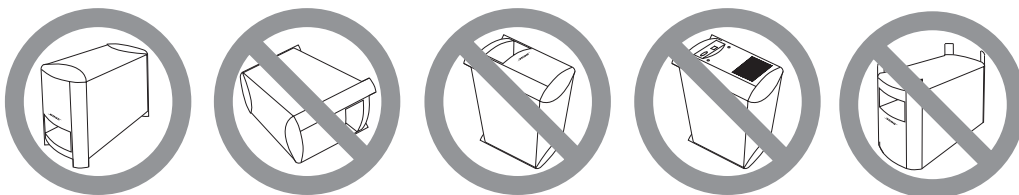

CAUTION: Do not block the openings on the back of the module, which provide ventilation for the built-in circuitry.

CAUTION: The Acoustimass module generates a magnetic field. Although this is not an immediate risk to your video tapes, audio tapes, and other magnetic media, you should not store any of these items directly on or near the module.

Making system connections

CAUTION: Do not plug the Acoustimass® module into an AC power (mains) outlet until all the components are connected.

Connecting the Acoustimass® module to the media center

Plug one end of the Acoustimass module cable into the **Acoustimass Module** jack on the rear of the media center (Figure 6). Plug the other end of the cable into the input (⊖ ⊕) jack on the rear of the Acoustimass module.

Note: The jacks for the Acoustimass module cable are keyed so that the cable connectors only plug in one way. Make sure that the arrow on the connector body faces up when plugging in the cable.

Figure 6

Acoustimass module-to-media center connection

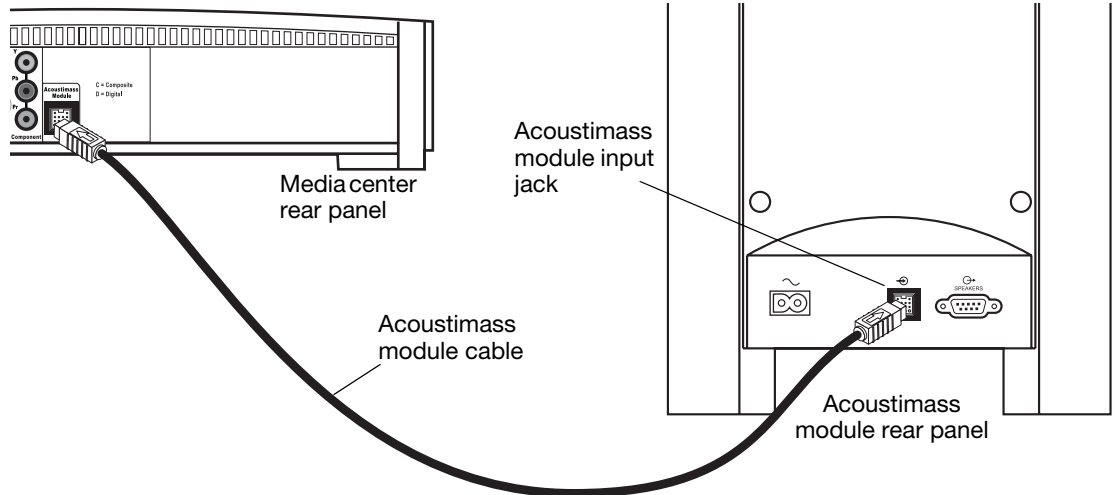

Connecting the speakers to the Acoustimass module

1. Insert the single-plug end of the speaker cable into the **SPEAKERS** jack on the rear panel of the Acoustimass module (Figure 7). Tighten both screws on the plug.

Figure 7

Speaker cable-to-Acoustimass module connection

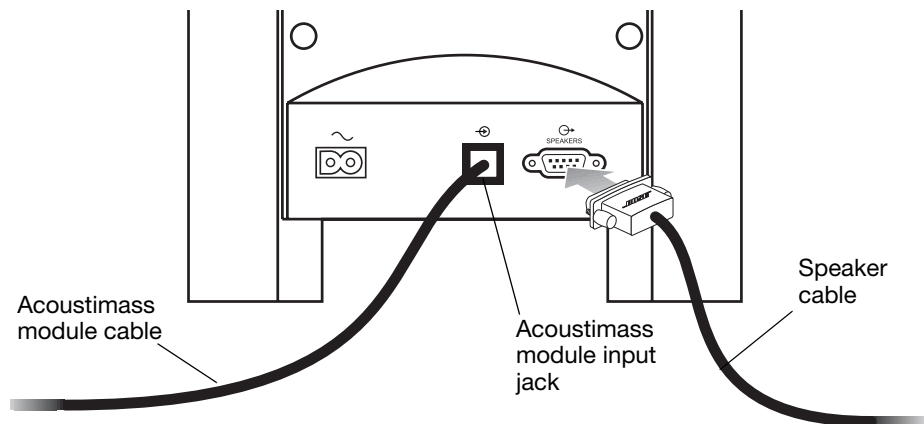

Note: If additional audio cables or longer cables are needed to make these connections, contact Bose® Customer Service. Refer to the list of offices included in the product carton.

2. At the other end of the speaker cable, separate the left and right speaker cords as much as necessary to reach each speaker (Figure 8).

Figure 8

Separating left and right speaker cords

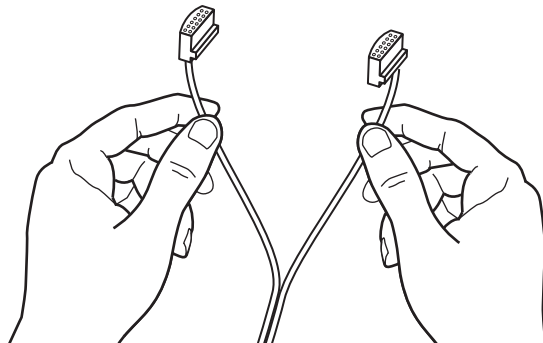

3. Plug the **LEFT** speaker cable into the rear jack of the left speaker (Figure 9). Plug the **RIGHT** speaker cable into the rear jack on the right speaker.

Figure 9

Left and right speaker connections

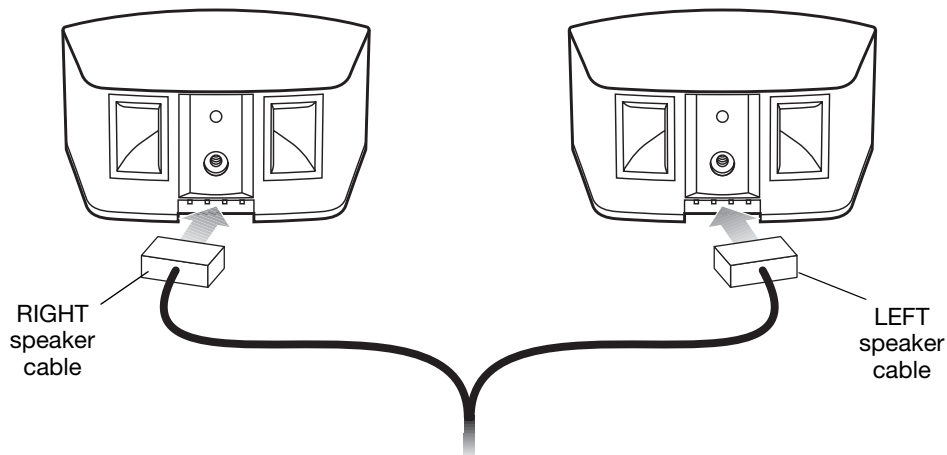

🎵 **Note:** Make sure cable connectors are fully inserted and seated firmly in the speaker jacks.

Connecting the supplied antennas

The rear panel of the media center provides jacks for the AM and FM antennas included with your system (Figure 10). Unwind the wires for each antenna to provide the best reception.

🎵 **Note:** An outdoor antenna may be used in place of the supplied indoor antennas. To add an outdoor antenna, consult a qualified installer. Follow all safety instructions supplied with the antenna.

Figure 10

Antenna connections

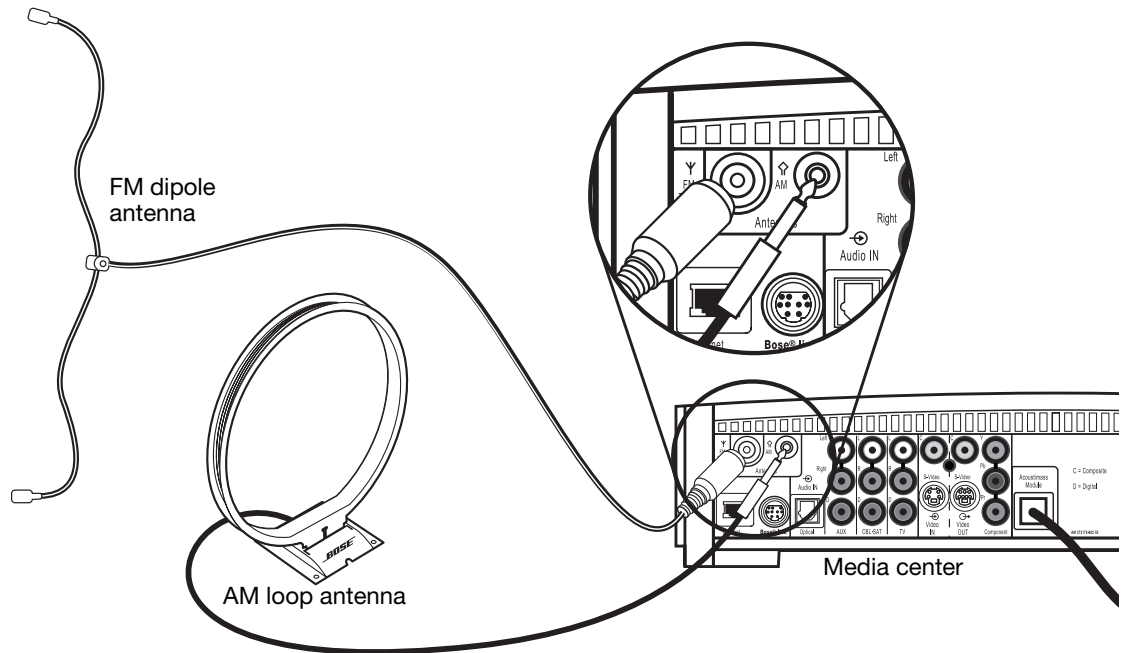

FM antenna

Plug the FM antenna into the **FM** jack on the media center rear panel. Spread out the antenna arms and move them around to establish optimum FM reception. Extend the antenna as far from the media center and other equipment as possible.

AM antenna

Plug the AM loop antenna into the **AM** jack on the media center rear panel. Place the antenna loop at least 20 inches (50 centimeters) away from the media center and at least 4 feet (1.2 meters) away from the Acoustimass® module. Experiment with positioning the loop for optimum AM reception. Follow the instructions enclosed with the AM loop antenna to stand it on the supplied base or mount it to a wall.

Connecting cable FM radio

Some cable TV providers make FM radio signals available through the cable service to your home. This connection is made to the external FM jack on the back panel of the media center. To connect to this service, contact your cable TV provider for assistance.

🎵 **Note:** Make sure that the cable radio installation includes a TV/FM splitter so that only the FM radio band, not the cable TV band, is received by the media center. If necessary, contact your cable company.

Connecting your TV to the media center

If you want to use the 3•2•1 GSX system with both a TV and a VCR, skip this section and go to “Connecting your TV and VCR to the media center” on page 16.

Making audio connections

♪ **Note:** If your TV does not have audio output jacks, see “Option B: TV (NO audio output jacks) + VCR + media center” on page 17. Otherwise, continue.

1. Connect one end of the supplied stereo cable to the **TV Audio IN** jacks on the rear panel of the media center (Figure 11). Insert the white RCA plug into the **TV** white **L** jack. Insert the red RCA plug into the **TV** red **R** jack.
2. Connect the other end of the stereo cable to the audio output jacks on your TV. Insert the white RCA plug into the white **AUDIO OUT L** jack. Insert the red RCA plug into the red **AUDIO OUT R** jack.

Making composite video connections

♪ **Note:** Some older TVs with standard TV cable connectors do not have a composite video or an S-video input. Such TVs are not compatible with any DVD players and require use of an RF modulator for this connection. RF modulators are available at your local electronics store.

1. Insert one end of the supplied video cable (yellow) to the **Video OUT C** (composite) jack on the back of the media center (Figure 11).
2. Insert the other end of the video cable into one of the video input jacks on your TV.

Figure 11

TV (composite video)-to-media center connections

Write the name of the video input jack used on your TV in the box on page 25. After you turn on the system, you will need to select this video input on your TV in order to view the 3•2•1 GSX system video output.

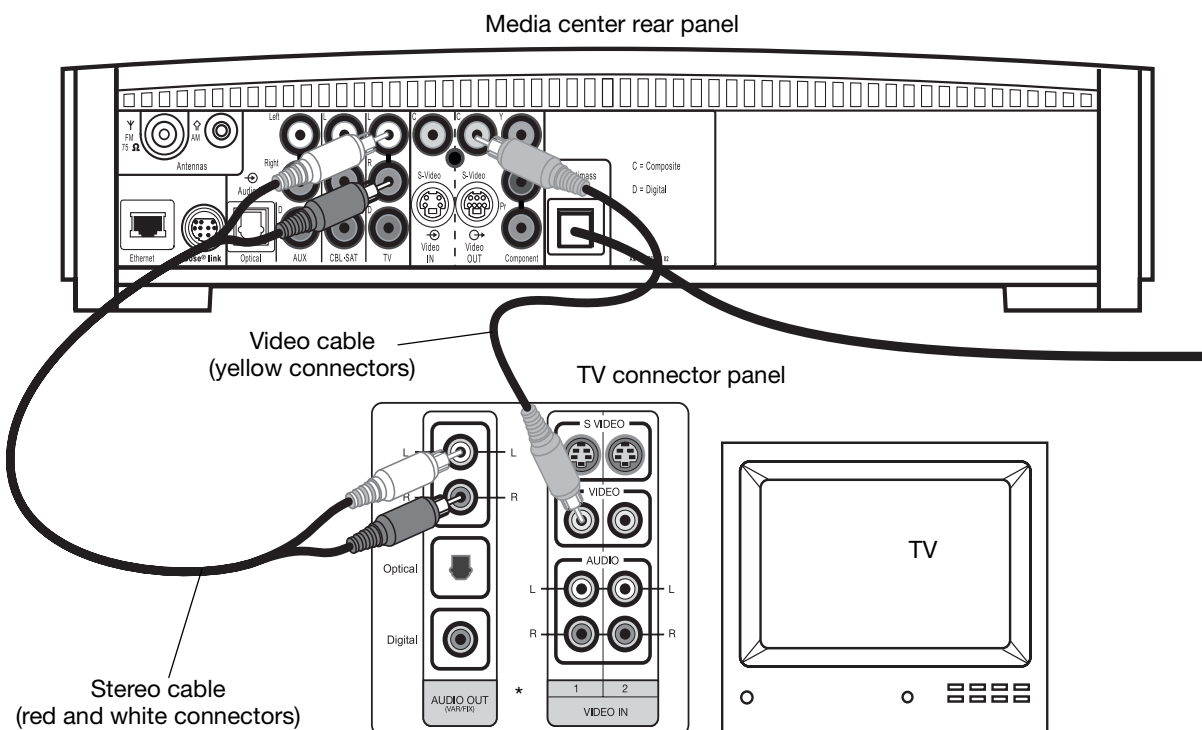

Connecting your TV and VCR to the media center

There are two options for connecting your TV and VCR to the media center.

- **Option A:** TV with audio output jacks+VCR
- **Option B:** TV *without* audio output jacks+VCR

Before proceeding, check your TV for audio output jacks.

Option A: TV (with audio output jacks) + VCR + media center

If your TV has audio output jacks, you can directly route the TV audio to the 3•2•1 GSX home entertainment system (Figure 12).

1. Connect one end of the supplied stereo cable to the **TV Audio IN** jacks on the rear panel of the media center. Insert the white RCA plug into the **TV white L** jack. Insert the red RCA plug into the **TV red R** jack.
2. Connect the other end of the stereo cable to the audio output jacks on your TV. Insert the white RCA plug into the white **AUDIO OUT L** jack. Insert the red RCA plug into the red **AUDIO OUT R** jack.
3. Insert one end of the supplied video cable (yellow) to the **Video OUT C** (composite) jack on the back of the media center. Insert the other end of the video cable into one of the video input jacks on your TV.

Figure 12

Option A connections

Write the name of the video input jack used on your TV in the box on page 25. After you turn on the system, you will need to select this video input on your TV in order to view the 3•2•1 GSX system video output.

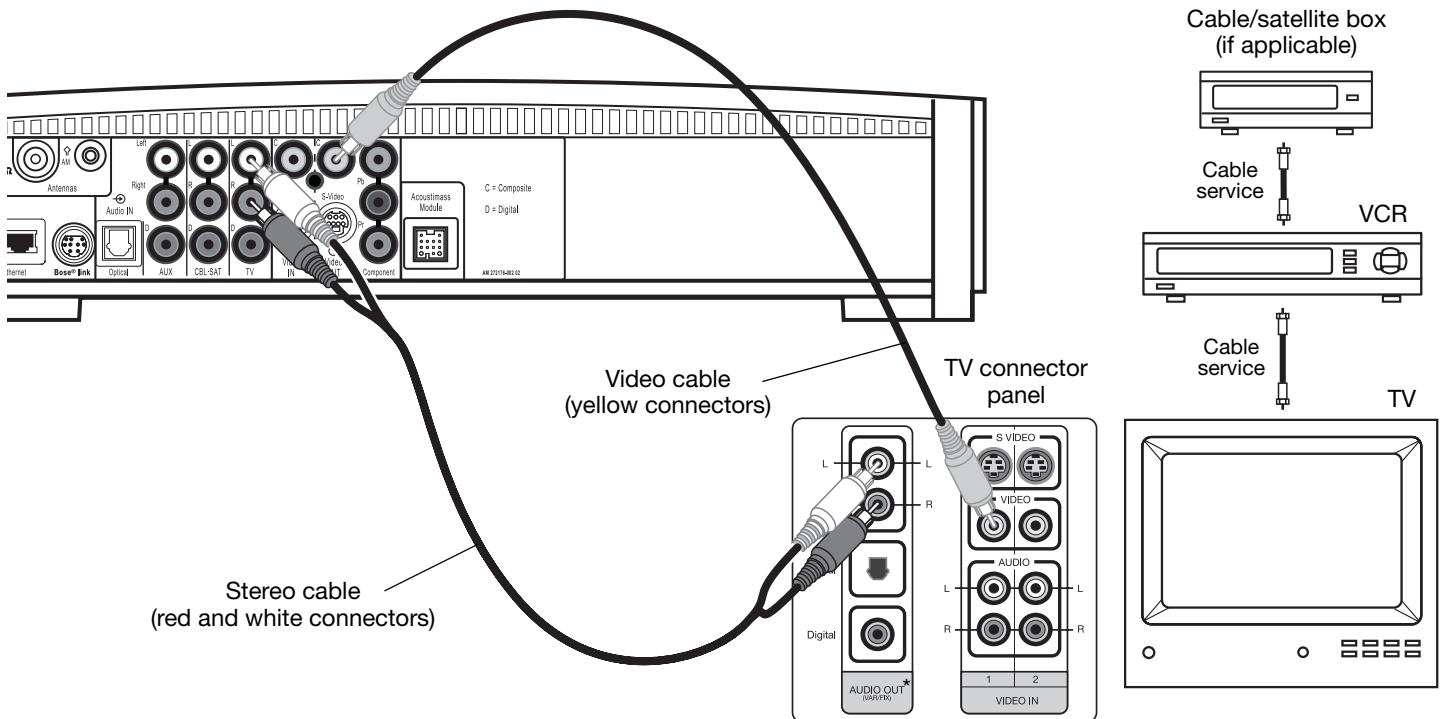

Option B: TV (NO audio output jacks) + VCR + media center

If your TV does not have audio output jacks, you will need to feed audio to the 3•2•1 GSX home entertainment system through a secondary source, such as a VCR. To do this, you will need one additional video cable, which can be purchased at your local electronics store.

1. Connect one end of the supplied stereo cable to the **AUX Audio IN** jacks on the rear panel of the media center (Figure 13). Insert the white RCA plug into the **AUX white L** jack. Insert the red RCA plug into the **AUX red R** jack.
2. Connect the other end of the stereo cable to the **AUDIO OUT** jacks on your VCR. Insert the white RCA plug into the white **AUDIO OUT L** jack. Insert the red RCA plug into the red **AUDIO OUT R** jack.
3. Insert one end of the supplied video cable (yellow) into the **VIDEO OUT** jack on the back of your VCR. Insert the other end of the cable into the **Video IN C** (composite) jack on the back of the media center.
4. Insert one end of the second video cable (yellow) into the **Video OUT C** (composite) jack on the back of the media center. Insert the other end of the cable into one of the video input jacks on your TV.

Figure 13

Option B connections

Write the name of the video input jack used on your TV in the box on page 25. After you turn on the system, you will need to select this video input on your TV in order to view the 3•2•1 GSX system video output.

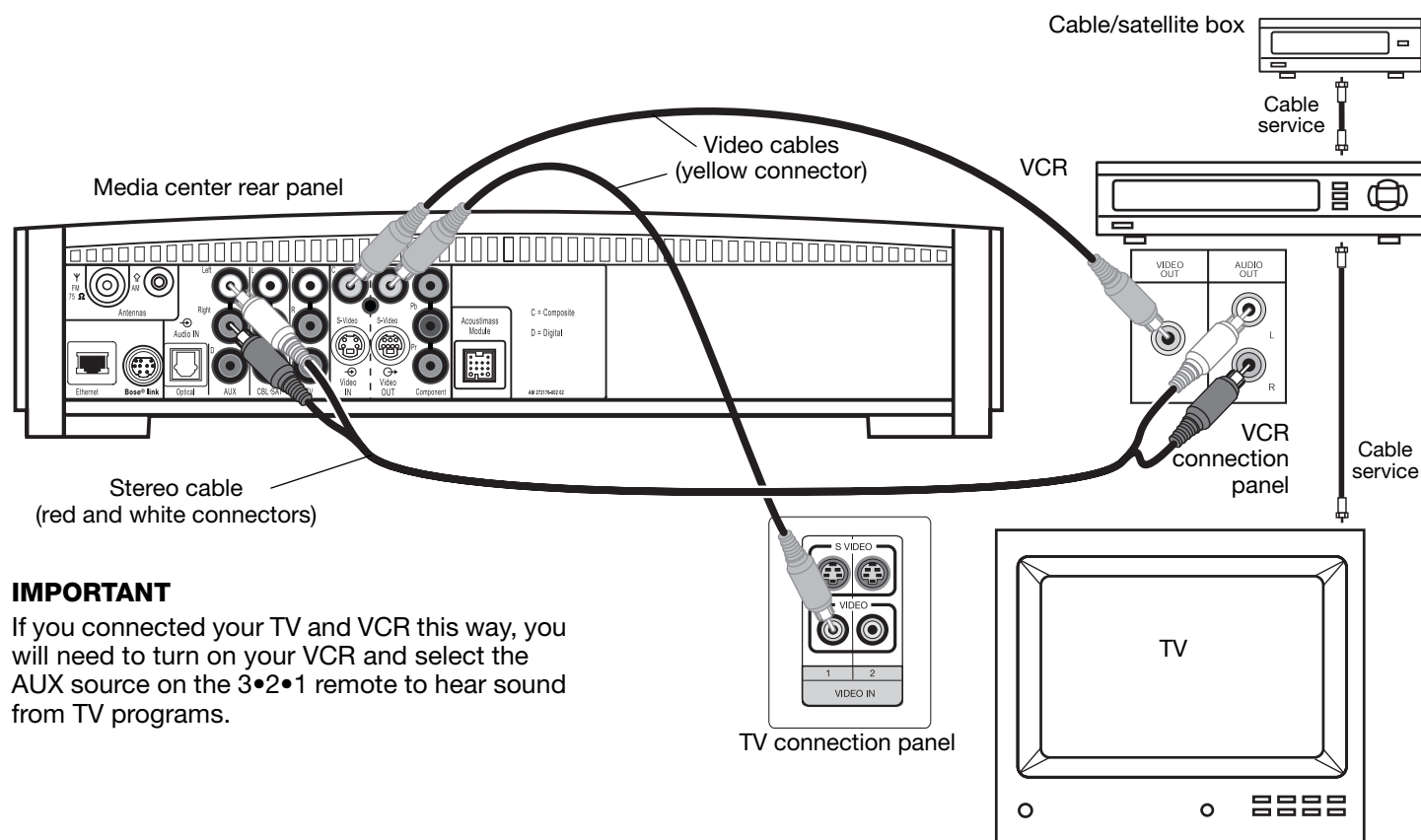
**IMPORTANT**

If you connected your TV and VCR this way, you will need to turn on your VCR and select the AUX source on the 3•2•1 remote to hear sound from TV programs.

VCR considerations

- Some combination TV/VCR units may not work with 3•2•1 GSX home entertainment systems. Please refer to your TV/VCR owner's manual for information.
- A stereo VCR is required for optimal sound performance. If your VCR has only one audio output, you have a mono VCR. You will need a Y-adaptor cable (available at electronics stores) to connect audio to the media center. For this setup, you will need to select "Mono decoding" (see "TV, CBL•SAT, and AUX Settings menu" on page 53) so your 3•2•1 GSX system will simulate surround sound effects from a mono source. Otherwise, you will hear mono sound from both speakers.

Advanced setup options

The 3•2•1 GSX home entertainment system provides connections for producing higher quality video and audio. The following describes how to use these connections.

Making S-video connections (higher-quality video)

An S-video input jack, provided on many TVs, delivers a higher-quality TV picture than the composite video output connection shown in Figure 11. For this connection, you will need an S-video cable, which can be purchased from your Bose® dealer or a local electronics retailer.

1. Insert one end of the S-video cable into the **S-Video OUT** jack on the media center (Figure 14).
2. Insert the other end of the S-video cable into the **S-VIDEO IN** jack on your TV.

Figure 14

TV (S-video)-to-media center connections

IMPORTANT

If you use S-video to connect your TV to the media center, you must also use S-video to connect all other devices (such as a cable box and VCR) to the media center.

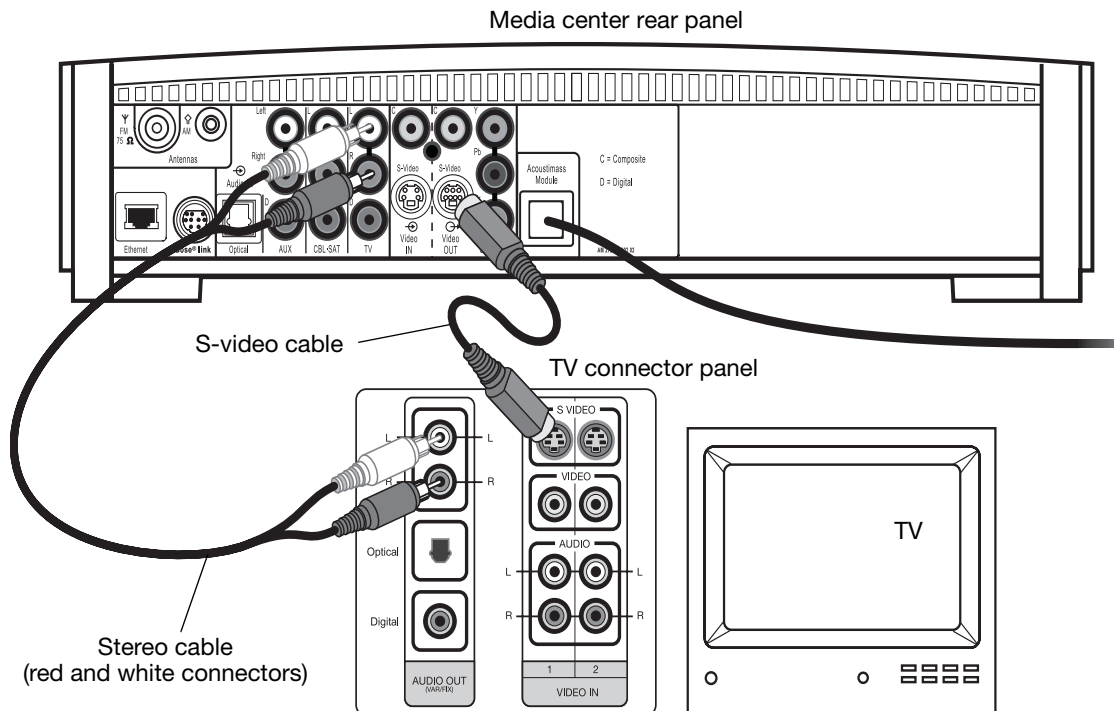

Making component video connections (highest-quality video)

Note: Component video connections are required in order to use the progressive scan (NTSC only) feature of your 3•2•1 GSX system. Your TV must also support this feature. To turn on the progressive scan feature, see “Video options” on page 60.

For the highest-quality video from DVDs, you may want to use a component video connection between the media center and the TV. To do so, your TV must provide component video jacks (typically labelled Y, Pb, and Pr). Refer to your TV owner’s guide for more information.

To make component video connections you will need a component video cable that is long enough to reach from the rear of the media center to your TV (Figure 15). If the cable is not supplied with your TV, you can purchase it separately.

1. On the media center rear panel, plug one end of the component video cable into the **Component Y, Pb, and Pr** video output jacks (Figure 15). Be sure to match the color of the plug with the color of the jack.
2. Plug the other end of the component video cable into the corresponding (color or letter code) component video jack on the back of your TV.

Figure 15

Component video TV-to-media center connections

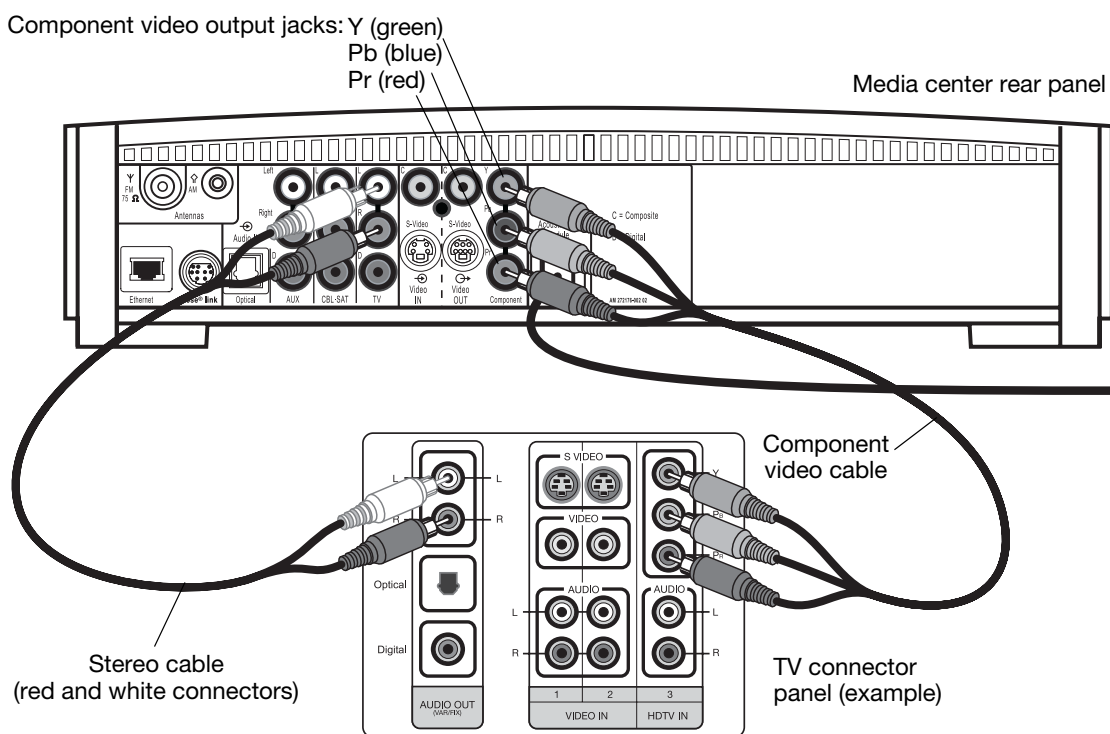

IMPORTANT FOR COMPONENT VIDEO USERS

Input signals received by the **C** (Composite) or **S-Video IN** jacks are not passed through to the **Component** video **OUT** jacks. If you connect an external video device to the **C** or **S-Video IN** jack, you must also connect the **C** or **S-Video OUT** jack on the media center to the respective video input jack on your TV. To view the external video input on your TV, you will need to select the TV video input used for that device. To view the onscreen menus of the 3•2•1 GSX system, you will need to switch back to the TV’s component video input.

Note: For more information, or to purchase the video cables, contact your local electronics store or authorized Bose® dealer.

Connecting digital audio devices

Some audio devices feature a digital audio output for optimum sound performance. Use an optical digital cable or a coaxial digital cable, as appropriate, to connect this output to the digital input on the media center. You can purchase the required cables at a local electronics store.

On the media center rear panel, an optical digital cable connects to the **Optical** jack. A coaxial cable connects to the audio input jacks labeled **D**.

Note: Before you can benefit from the optical connection, you will need to assign the optical connector to the audio source in the system settings menu. See “Media center options” on page 61.

Figure 16

Media center digital audio input jacks

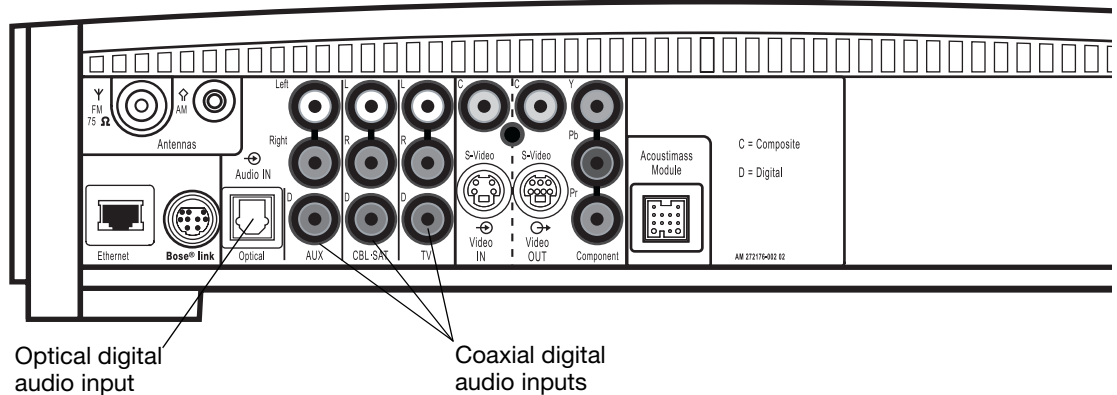

Connecting your cable/satellite box, TV, and VCR to the media center

The 3•2•1 GSX home entertainment system provides flexibility for you to add up to three external audio devices, including your TV, directly to the media center.

Figure 17 shows you an advanced setup using a TV, VCR, and cable/satellite box. In this setup, please notice the following:

- S-video connections are used to deliver the cable/satellite signal to the media center. Therefore, the media center output video is sent to the TV also through an S-video connection.
- Analog and digital coaxial audio connections are shown for the cable/satellite box. As an option, you may use an optical digital connection. However, before you can benefit from the optical connection, you will need to assign the optical connector to the cable/satellite box audio source in the system settings menu. See “Media center options” on page 61.
- When connecting an audio device to the media center jacks, remember to match the red jack to the right channel (R) and the white (or black) jack to the left channel (L).
- For further details on making the video connections between your VCR and TV, refer to the manuals for these video devices.

Note: The recommendations contained in this owner’s guide are basic suggestions for connecting external devices to the 3•2•1 GSX system. Instructions and terminology pertinent to these external devices may vary, depending on the manufacturer. Consult the owner’s guide that came with the device for clarification on setup and usage before making any connections.

Figure 17

Advanced setup example:
TV, VCR, and cable/satellite
box

For future use only.

Media center

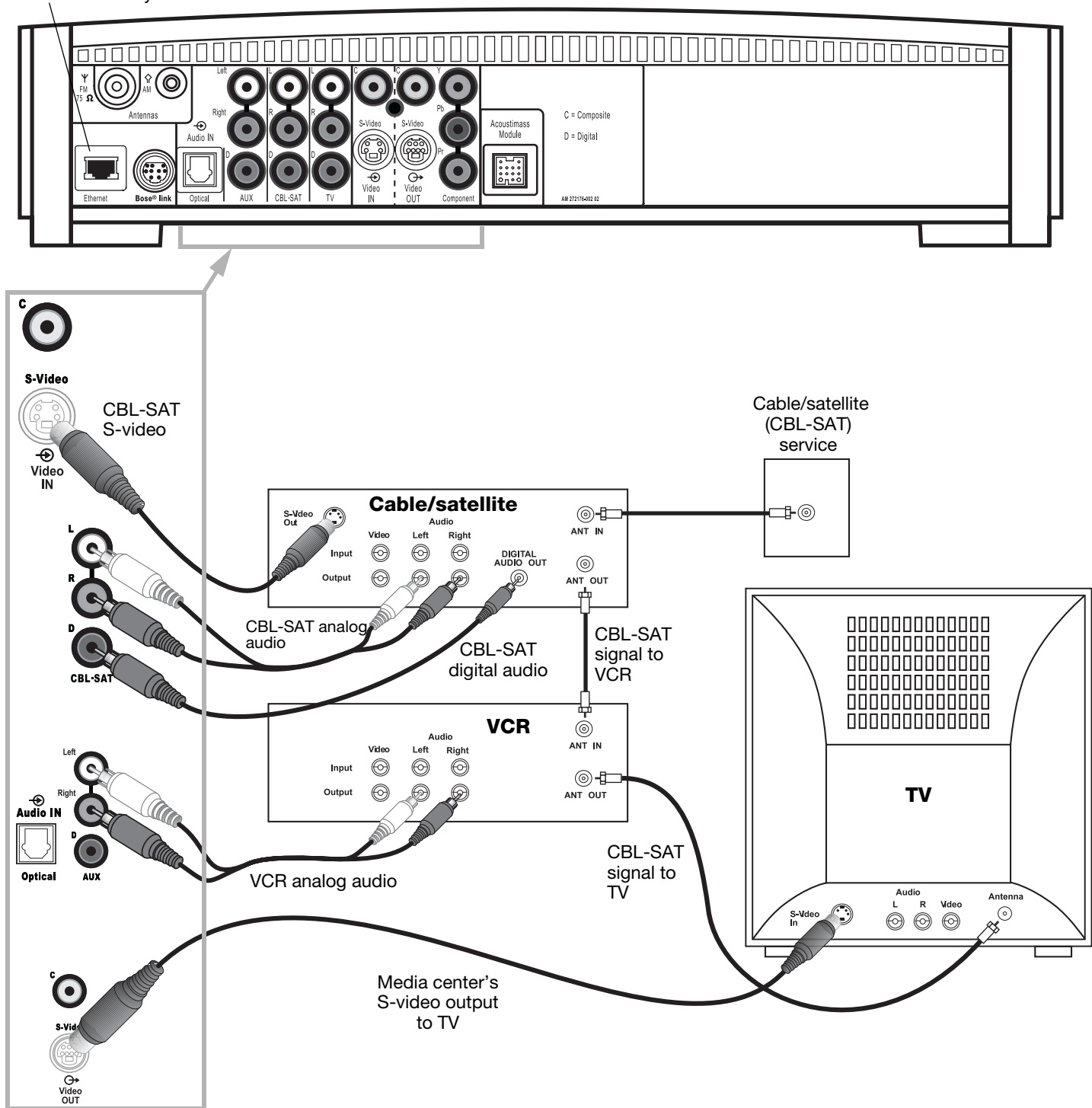

Note: For more information on advanced connections, refer to the DVD setup disc that came with your 3•2•1 GSX home entertainment system.

Connecting a game console

Connect the audio output of a game console to the **AUX Left** and **Right** input jacks. Connect the video output of the game console to the **C** (composite) **Video IN** jack.

Figure 18

Game console connections

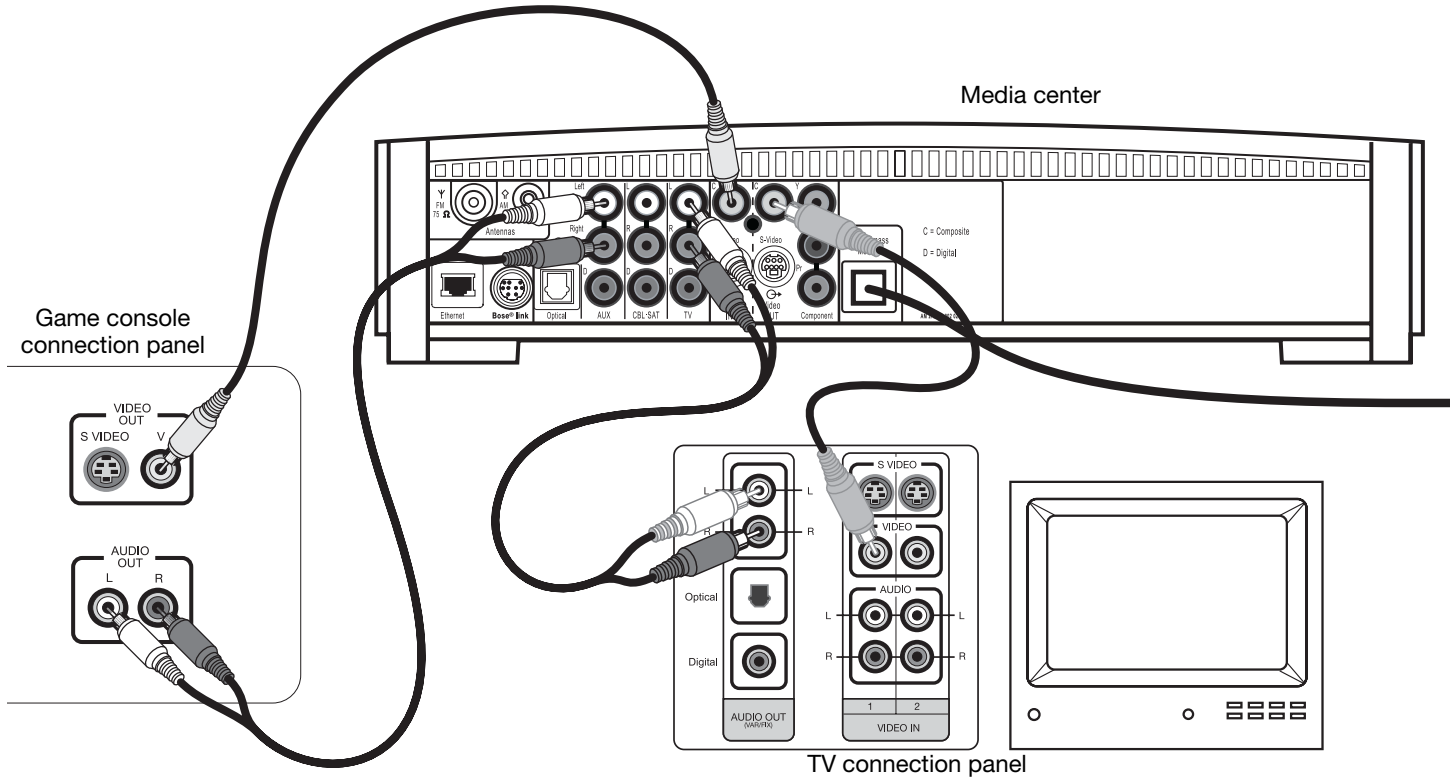

IMPORTANT

If you connected your game console this way, you will need to select the AUX source on the 3•2•1 remote in order to hear sound from the game console.

Installing the remote control batteries

1. On the back of the remote, slide open the battery compartment (Figure 19).
 2. Insert the two supplied AA (IEC-R6) 1.5V batteries, or their equivalent, as shown. Match the plus (+) and minus (-) marked on the batteries with the plus (+) and minus (-) inside the battery compartment.
 3. Slide the battery compartment cover back into place.
- Note:** Replace the batteries when the remote control stops operating or its range seems reduced.

Figure 19

Installing the batteries

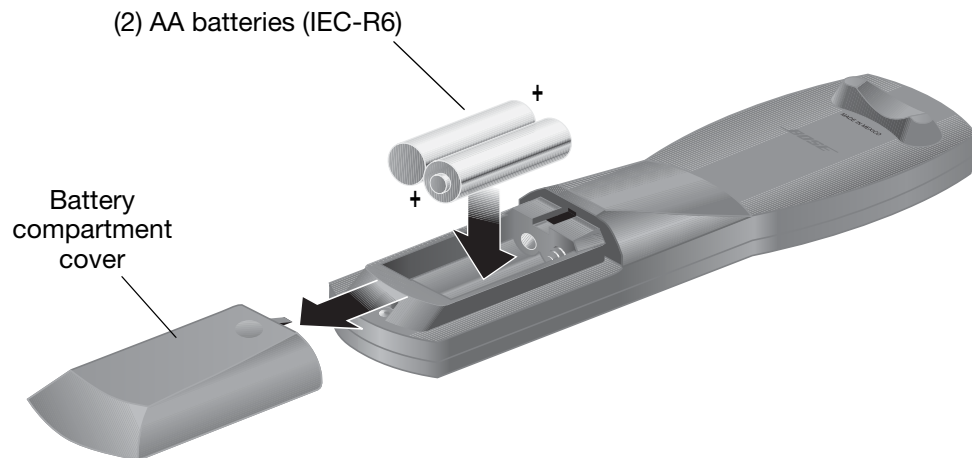

Connecting the power cord

⚠ CAUTION: Do not plug the Acoustimass® module into an AC power (mains) outlet until all the components are connected.

⚠ CAUTION: For dual voltage models only, be sure to set the dual voltage switch on the back of the Acoustimass module to the appropriate voltage for your area (115V or 230V) before connecting to power. If you are not sure about the proper voltage for your area, consult your local electrical authorities.

1. Insert the small connector end of the power cord into the AC INPUT connector on the Acoustimass module (Figure 20).
2. Insert the large end of the cord into an AC power (mains) outlet.

🎵 Note: On 220-240V models only, turn the Acoustimass module POWER switch to on (I).

Figure 20

Connecting to power

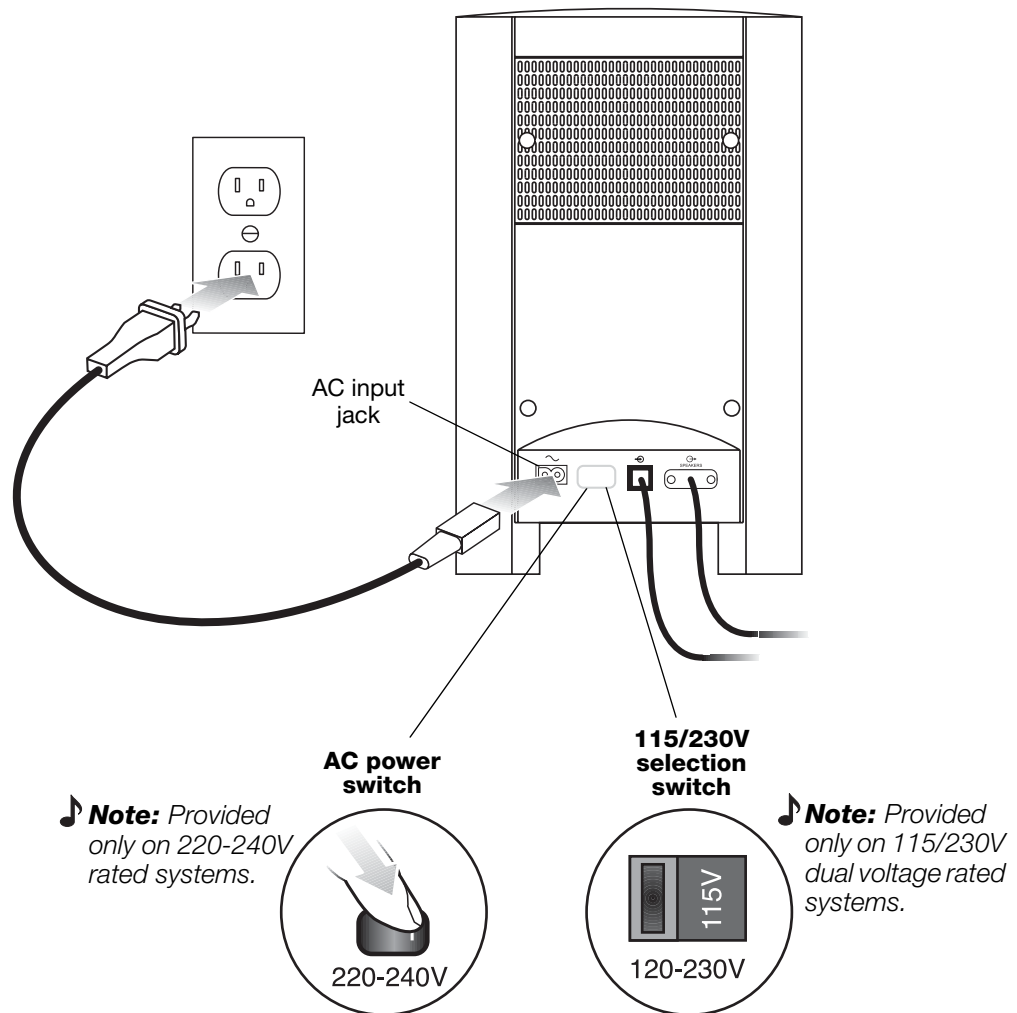

🎵 Note: Bose recommends using a safety agency-approved surge protector on all electronic equipment. Voltage variations and spikes can damage electronic components in any system. A quality suppressor can eliminate the vast majority of failures attributed to surges and may be purchased at electronics stores.

Verifying your system setup

Follow these steps when turning on your system for the first time. Be sure to perform step 4 and play the setup DVD. The setup DVD can help you verify that you set up your system correctly for proper sound performance.

1. Check the following before you continue:

- All cables are connected for the setup you chose.
- The batteries were installed in the remote control.
- The power cord was installed and plugged into a live AC receptacle.

2. Turn on your TV.

Use the remote control that came with your TV.

3. Using your TV remote, select the video input on your TV that connects to the video output of the media center.

Name TV video input used:

- The method of selecting the right video input depends on your TV. Refer to your TV owner's guide for help.

4. Play the 3•2•1 GSX setup DVD.

- A. Turn on your 3•2•1 GSX system. Point the 3•2•1 GSX remote control at the media center and press **On-Off**.
- B. Press **Eject** on the media center control panel.
- C. Insert the DVD setup disc into the disc tray.
- D. Press **Eject** again to close the tray. The DVD will automatically begin to play. If it does not, press the play button ().

5. Turn off the TV speakers.

- Refer to your TV owner's guide for help.
- If your TV does not have an option to turn off the internal speakers, you may need to adjust both the 3•2•1 GSX system volume and your TV volume until you find a level that produces the desired sound.
- In some TVs, when the internal speakers are turned off, you may need to raise the TV's volume level by 75% to 100% in order to hear audio from the 3•2•1 GSX home entertainment system. See your TV owner's guide for help.

 **Note:** Be sure to play the setup DVD, included in the carton with your system, as soon as all the connections are completed. This will help you verify the connections you have made and confirm proper sound performance.

SYSTEM CONTROLS AND INDICATORS

Remote control

Remote status LED



- Turns the system on or off.



Status LED:

- Off (unlit) during normal operation.
- On during the process of setting up the remote to control other equipment such as your TV or VCR.



- Silences or restores the sound from the current source.



- Selects the Stored CD source and turns on the system to the last-selected uMusic® intelligent playback system play mode.



- Selects the built-in CD/DVD player and turns on the system.



- Selects the built-in tuner and turns on the system to the previously selected FM/AM station.
- Switches between FM and AM when the tuner is selected.



- **TV:** Selects the TV sound source and turns on the system.



- **Input:** Changes the external input to your TV. For example, your TV might have two external inputs where one is connected to your cable box and the other to your VCR. Pressing this button alternates between the cable box and the VCR.*

- **On/Off:** Turns your TV on and off.*



- **CBL-SAT:** Selects the CBL-SAT sound source and turns on the system.



- **On/Off:** Turns your cable/satellite box on or off.*



- **AUX:** Selects the AUX sound source and turns on the system.









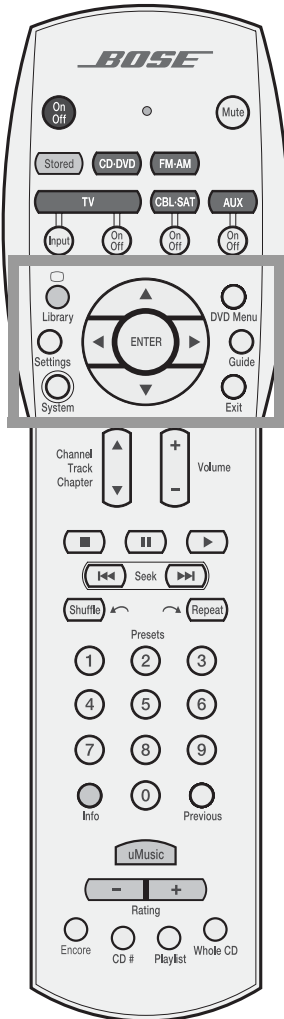

- **On/Off:** Turns a VCR or PVR that is connected to the AUX jack on or off.*

* Requires special remote settings. See "Setting up your remote to control other audio/video devices" on page 31.

Remote control – cont.

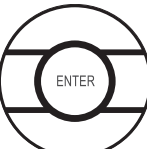

- 
 - When **Stored** is the selected source, enters the library of stored CD tracks.
- 
 - Displays the Settings menu for the current source on your TV screen or media center display.
- 
 - Displays the System menu on your TV screen.
- 
 - Displays the DVD menu of the currently loaded DVD disc on your TV screen.
 - Displays the main menu of a cable/satellite box, VCR, or PVR on your TV screen (if supported).*
- 
 - Puts the TV, cable, satellite, or DVR program guide (if supported) on your TV screen.
- 
 - Removes the Settings and System menus from your TV screen.
 - Removes on-screen menus for TV, cable/satellite box, or VCR/DVR from your TV screen.*
- 
 - Tunes the FM or AM radio to the next higher or lower frequency.
 - Selects the next item, up or down, in menus.
- 
 - Confirms a menu selection or introduces the next level of menu options.
- 
 - Moves up, down, left, or right in on-screen menus and media center displays.

*Requires special remote settings. See "Setting up your remote to control other audio/video devices" on page 31.

Remote control – cont.

SYSTEM CONTROLS AND INDICATORS

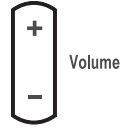
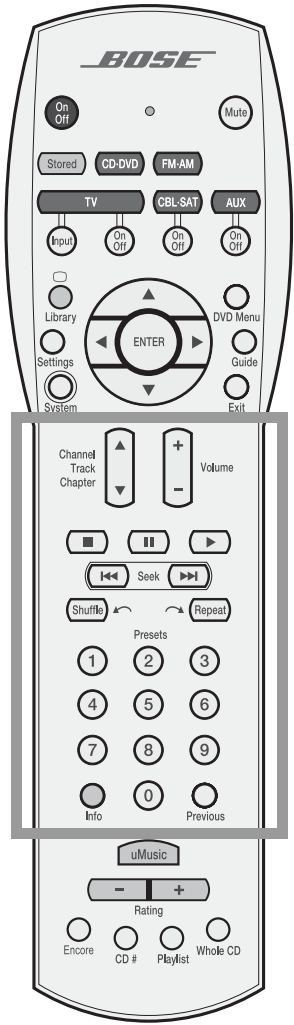

Volume

- Raises or lowers the volume of the current source.
- Pressing + restores muted sound from the current source.
- Pressing – lowers the volume of the current source, but does not restore muted sound.



Channel Track Chapter

- Skips to the next or previous TV channel,* CD track, or DVD chapter.



- Stops the disc player.
- For DVDs only, the disc stops and the system saves the DVD play position. Pressing [Play/Pause] continues the DVD from the saved play position. Pressing [Stop] twice for a disc in play returns to the beginning of the disc.



- Pauses a currently playing disc.
- Pressing [Pause] again (or pressing [Play/Pause]) resumes play of a paused disc.
- After 20 minutes of no user interaction, the disc player stops and returns to the beginning of the disc to wait for the next command.



- Starts the disc player.



- Skips backward or forward through CD tracks, DVD chapters, or to the next strongest radio station.



- Plays audio CD tracks in random order. Press again to cancel.
- Starts instant replay (↶) for DVR (if supported).



- Repeats a CD, CD track, DVD chapter, or DVD title depending on the selected source. Press again to change the repeat mode.
- Initiates Quick Skip and/or Return to Live (↶) for DVR (if supported).

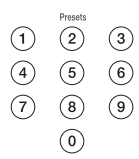

Presets

- Selects a CD track, DVD chapter, radio station preset, or TV channel.
- Selects a uMusic® preset for the Stored source.
- Allows numerical selection for some menu options.



Info

- Displays or dismisses a cable/satellite information window (if supported).
- If playing an MP3 CD, displays or dismisses artist and title information on the media center display panel.
- Displays information about the stored track that is playing.



Previous

- Skips to the previous TV channel (if supported by your TV or cable/satellite box).

* Requires special remote settings. See "Setting up your remote to control other audio/video devices" on page 31.

Remote control – cont.

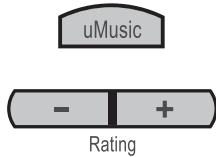
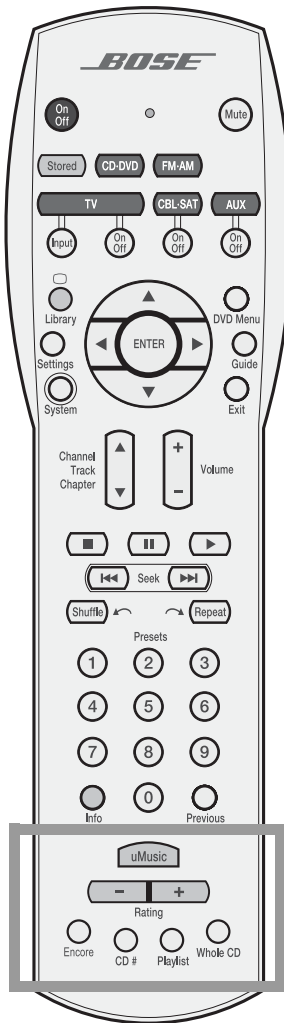

Rating



Encore



CD #



Playlist



Whole CD

In Stored source, selects the uMusic® intelligent playback system for playing stored music. Overrides any other stored music play mode.

• *In Stored source*, applies a negative (-) or positive (+) rating to the stored track currently playing. Pressing - immediately selects a new track. Pressing + continues playing the current track.

• *In an on-screen program guide*, scrolls down (-) or up (+) to reveal additional content for your cable, satellite box, or VCR/DVR.*

In Stored source, selects and plays stored music that most closely matches the style of the current track.

In Stored source, plays the tracks from a CD selected by its number in the uMusic system.

In Stored source, plays all the tracks, if any, assigned to the playlist. Can be used with other play mode options, like Encore.

In Stored source, skips from the track most recently playing to the first track on the CD of origin and plays that CD from beginning to end.

*Requires special remote settings. See "Setting up your remote to control other audio/video devices" on page 31.

Remote control – cont.

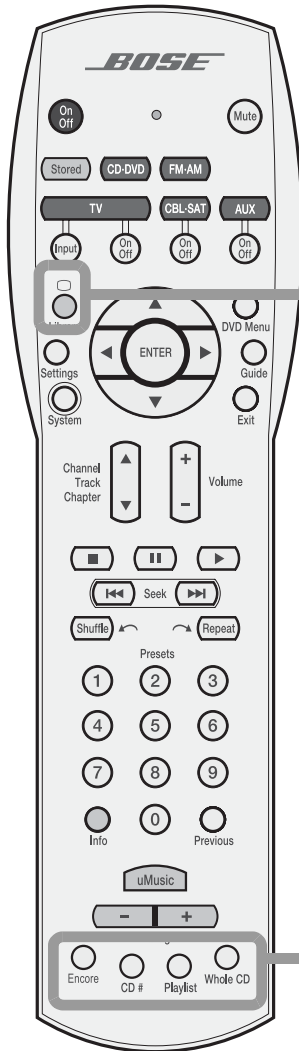

Aspect ratio or Teletext On/Off control

You will see one of two symbols above the Library button on your remote control. The symbol defines the function.

Symbol	Function
	When a video source is selected, changes the video aspect ratio between Normal (4:3) and Widescreen (16:9).
	For Europe, only When the TV source is selected, turns the Teletext mode On or Off.

Recording/Cable or Teletext controls

These four buttons will be marked in one of two ways on your remote. The markings define how the buttons are used.

Button markings	Functions
<p>Red (Record)</p>	<ul style="list-style-type: none"> When a VCR, DVR, or other video recording device is selected, the Red button activates the record function.* When a cable source is selected, A, B, and C are used for cable-related functions.*
<p>Red Green Yellow Blue</p>	<p>For Europe, only In the Teletext mode, the colored buttons are used for Teletext-related functions.</p>

* Requires special remote settings. See "Setting up your remote to control other audio/video devices" on page 31.

Setting up your remote to control other audio/video devices

Your remote can be set up to control other audio/video devices such as a TV, VCR, PVR, or cable/satellite box by entering a device code while in the setup mode.

- **If you know the device code, follow the instructions under the heading, “Direct entry of a device code”** below. Device codes are listed in the back section of this owner’s guide and in the System menus under Remote Control options.
- **If you can’t find the device code and want to search the system for it, see “Searching for a device code” on page 32.**
- **If you want to verify the device code you have entered for an audio/video device, see “Verifying an entered device code” on page 34.**
- **If you want to return to a previous device assignment,** press and hold the **TV** button until the remote LED is lit (about 5 seconds). On the remote keypad, enter 977.
- **If you want to wipe out all assigned codes,** press and hold the **TV** button until the remote LED is lit (about 5 seconds). On the remote keypad, enter 981.

♪ **Note:** More than one code may work with your particular brand of product. If you notice a lack of response or limited functionality after setting up the remote, try a different code.

♪ **Note:** The remote status LED flashes rapidly eight times if you press an invalid key, or enter an unavailable device code. Wait seven seconds for the error to clear and start again.

Direct entry of a device code

Device codes can be found at the back of this owner’s guide or in the System menu under Remote Control options. If you know the device code, you can do the following:

To set up the remote to control your TV

1. Turn on both the 3•2•1 GSX system and your TV.
2. Press and hold the **TV** button until the remote LED is lit (about five seconds).
3. On the remote keypad, enter the four-digit device code for your TV. The LED will turn off temporarily as you press each key.
4. Check that the LED turns off after the code is entered. If the LED blinks, the code is invalid. Try again.
5. Point the remote at your TV and press the **TV On-Off** button. If your TV does not respond, go back to Step 2 and try other codes. If you are still unsuccessful, see “Searching for a device code” on page 32.

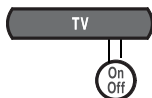

♪ **Note:** After programming your remote to control external audio/video devices from the System menu, press the System button once to continue navigating the System menu.

To set up the remote to control your cable/satellite box

1. Turn on both the 3•2•1 GSX system and your cable/satellite box.
2. Press and hold the **CBL-SAT** button until the remote LED is lit (about five seconds).
3. On the remote keypad, enter the four-digit device code for your cable/satellite box. The LED will turn off temporarily as you press each key.



4. Check that the LED turns off after the code is entered. If the LED blinks, the code is invalid. Try again.



5. Point the remote at your cable/satellite box and press the **CBL-SAT On-Off** button. If your cable/satellite box does not respond, go back to Step 2 and try other codes. If you are still unsuccessful, see “Searching for a device code” below.

To set up the remote to control your VCR or PVR (such as TiVo or Replay TV)



1. Turn on both the 3•2•1 GSX system and your VCR or PVR.
2. Press and hold the **AUX** button until the remote LED is lit (about five seconds).
3. On the remote keypad, enter the four-digit device code for your VCR/PVR. The LED will turn off temporarily as you press each key.
4. Check that the LED turns off after the code is entered. If the LED blinks, the code is invalid. Try again.



5. Point the remote at your VCR or PVR and press the **AUX On-Off** button. If your VCR or PVR does not respond, go back to Step 2 and try other codes. If you are still unsuccessful, see “Searching for a device code” below.

Searching for a device code

Use this method if you do not know the code for a device.

Note: *This is a very time-consuming process. Use it as a last resort.*

To set up the remote to control your TV

1. Turn on both the 3•2•1 GSX system and your TV.
2. Press and hold **TV** until the remote LED is lit (about five seconds).
3. Alternately press **Channel ▲** and **TV On-Off** until your TV turns off.

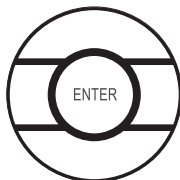
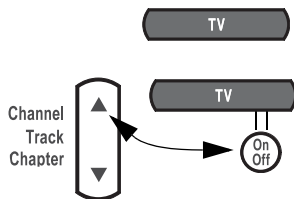

4. Press **Enter**. Check that the remote LED turns off.

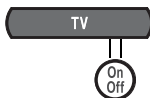

5. Point the remote at your TV and press **TV On-Off**. If your TV does not respond, go back to Step 2 and try again.

To set up the remote to control your cable/satellite box

1. Turn on both the 3•2•1 GSX system and your cable/satellite box.
2. Press and hold **CBL-SAT** until the remote LED is lit (about five seconds).
3. Alternately press **Channel ▲** and **CBL-SAT On-Off** until your cable/satellite box turns off.

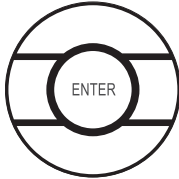
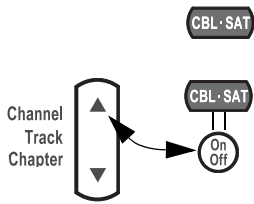

4. Press **Enter**. Check that the remote LED turns off.



5. Point the remote at your cable/satellite box and press **CBL-SAT On-Off**. If your cable/satellite box does not respond, go back to Step 2 and try again.

To set up the remote to control your VCR or PVR (for example, TiVo or Replay TV)

1. Turn on both the 3•2•1 GSX system and your VCR/PVR.
2. Press and hold **AUX** until the remote LED is lit (about five seconds).
3. Alternately press **Channel ▲** and **AUX On-Off** until your VCR/PVR turns off.

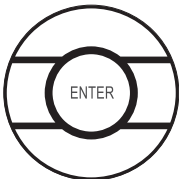
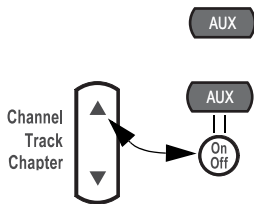

4. Press **Enter**. Check that the remote LED turns off.



5. Point the remote at your VCR/PVR and press **AUX On-Off**. If your VCR/PVR does not respond, go back to Step 2 and try again.

Verifying an entered device code

In case you need to check to see what code the remote is using for a particular device, do the following:



1. Press and hold a source key (**TV**, **CBL-SAT**, or **AUX**) until the remote LED lights (about five seconds).
2. Press the **Info** button.
3. Press **1** on the remote and count the number of times the LED blinks (zero is indicated by a long blink). This is the first digit.
4. Press **2** on the remote and count the number of times the LED blinks (zero is indicated by a long blink). This is the second digit.
5. Press **3** on the remote and count the number of times the LED blinks (zero is indicated by a long blink). This is the third digit.
6. Press **4** on the remote and count the number of times the LED blinks (zero is indicated by a long blink). This is the fourth digit.



7. Press **Exit**.

Changing the default TV channel control

With the TV source selected, your remote is set at the factory to select TV channels using your TV. If you wish to use your VCR or cable/satellite box to select TV channels, you can change the default setting in your remote.

To change the default TV channel control:



1. Press and hold **Previous** on the 3•2•1 remote. The remote status LED will illuminate and blink once for TV (factory setting), twice for CBL-SAT, or three times for AUX to identify the default TV channel control.
2. After the blinking stops, press the source button (**TV**, **CBL-SAT**, or **AUX**) that corresponds to the device you want to use for selecting TV channels.



3. Press **Exit** on the 3•2•1 remote.

To confirm, press and hold **Previous** on the 3•2•1 remote and count the number of blinks. If the change was made, press **Exit**. If not, repeat steps 2 and 3.

Media center

The media center has a control panel on the top, a display area to show the current status of the system, and a disc tray that opens on the front of the console.

Control panel

The media center has six buttons located above the display.

Figure 21

Media center controls

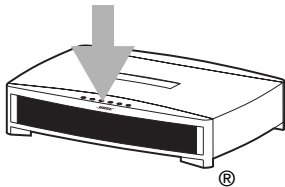

On-Off



Turns system power on or off.

Source



Steps through the available source selections.

- Volume +



Lowers and raises the volume level.



Store



Copies tracks from an audio CD into the music library.

Eject



Opens or closes the disc tray.

Note: If you select another source by pressing the **Source** button, you cannot control the new source with the remote until you press the button for that new source on the remote.

Display indicators

With the system turned on, the media center display lights up to show the state of the system. Not all possible choices, shown below, light up at once (Figure 22). The display changes with each adjustment or selection you make.

Figure 22

Example media center display

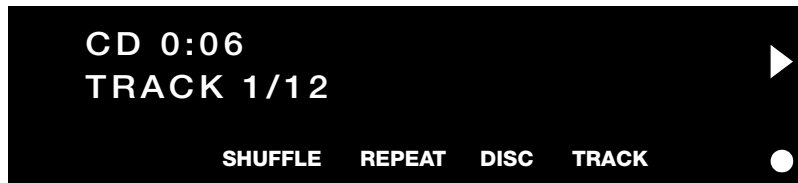

Lights to indicate disc is in play.

Lights briefly when a remote control command is received.

Indicates shuffle mode is selected for the current disc.

Indicates repeat mode is selected for current track or disc.

Indicates "Repeat Disc" or "Shuffle Repeat Disc" mode is selected.

Indicates "Repeat Track" mode is selected.

OPERATION

Turning your system on and off



To turn power on or off:

- Point the 3•2•1 remote at the media center and press **On/Off**.
- OR
- Press **On/Off** on top of the media center.

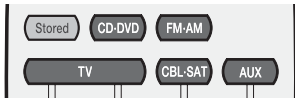

To turn on the system and select a source at the same time:

- Press **Stored**, **CD•DVD**, **FM•AM**, **TV**, **CBL•SAT**, or **AUX** on the 3•2•1 remote.

Note: Your 3•2•1 remote control can be set up to control other audio/video devices such as your TV, VCR, or cable/satellite receiver. For instructions, see “Setting up your remote to control other audio/video devices” on page 31.

Playing video DVDs

Before you play your first DVD:

- Familiarize yourself with the 3•2•1 remote control. See “Remote control” on page 26.
- Be sure you understand how to switch between the available video inputs on your TV. To view a video DVD, you will need to select the video input on your TV that is connected to the video output of the 3•2•1 GSX media center (see “Connecting your TV to the media center” on page 15).
- If you are unable to select the correct video input on your TV, please consult your TV owner’s guide.
- Be sure that you play the 3•2•1 GSX system setup DVD first. This will help you verify the connections you have made and confirm proper sound performance.

1. Turn on your TV.
2. Select the correct video input on your TV for the 3•2•1 GSX system.
3. On the 3•2•1 remote, press **CD•DVD** to turn the 3•2•1 GSX system on to the CD/DVD source.



Eject



4. On the media center control panel, press **Eject** to open the disc tray.

Eject



5. Place the DVD in the disc tray.
6. Press **Eject** again to close the tray.



The DVD should begin to play automatically. If not, press **Play** on the 3•2•1 remote.

Note: Not all DVDs offer the same features. For example, you can choose to display subtitles while watching a movie only if that particular disc provides subtitle information.

While playing a DVD video, the media center displays the elapsed play time and chapter number.

Figure 23

Sample display for a DVD video

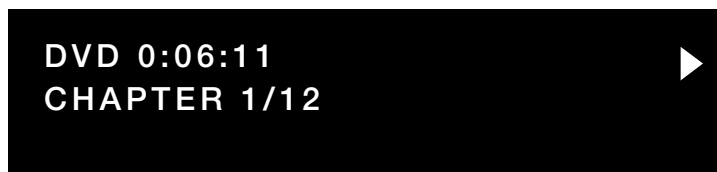

Basic DVD operations



- Press **Pause** to pause a movie.



- Press **Pause** again, or press **Play** to resume playing a paused DVD.



- Press **Stop** to interrupt a movie in progress.
 - Press **Stop** once. The system holds the movie at the point of interruption. Press **Play** to resume from the point of interruption.
 - OR
 - Press **Stop** twice. Play is interrupted and the system returns to the beginning of the disc. Press **Play** to restart the DVD.



- Press **Chapter** ▲ to skip to the next chapter on the current DVD. Press **Chapter** ▼ to skip to the previous chapter.



- Press **Repeat** once for REPEAT CHAPTER mode.
- Press **Repeat** again for REPEAT TITLE mode.
- Press **Repeat** again to turn off the repeat function (REPEAT OFF).



- Press ◀◀ to scan backward through the current DVD. Press ▶▶ to scan forward.

Eject



- Press **Eject** on the media center to stop a disc and open the disc tray.

🎵 **Note:** For information on changing DVD-related source settings, see “DVD Settings menu” on page 52.

Restricting access to video DVDs

The DVD Lock menu allows you to restrict access to DVD content that is inappropriate for certain members of your family. For instructions on using the DVD Lock menu, see “DVD Lock options” on page 63.

Playing audio CDs



Eject



Eject



1. On the 3•2•1 remote, press **CD•DVD** to turn the 3•2•1 GSX system on to the CD/DVD source.
2. On the media center control panel, press **Eject** to open the disc tray.
3. Place the CD disc in the disc tray.
4. Press **Eject** again to close the tray.
5. The audio CD should begin to play automatically. If not, press **Play** on the 3•2•1 remote.

Basic CD operations



- Press **Pause** to pause an audio CD.



- Press **Pause** again, or press **Play** to resume playing a paused CD.



- Press **Stop** to stop a playing audio CD.



- Press **Track ▲** to skip to the next track on the current CD. Press **Track ▼** to skip to the previous track.



- Press **Seek ►►** once to skip to the next track.
- Within the first 2 seconds of play, press **Seek ◀◀** to skip to the previous track. After 2 seconds of play, press **Seek ◀◀** to skip to the beginning of the current track.
- Press and hold **Seek ◀◀** or **Seek ►►** to scan backward or forward through a track.



- Press **Repeat** once for REPEAT TRACK mode. Press **Repeat** again for REPEAT DISC mode. Press **Repeat** again to turn off the repeat functions (REPEAT OFF).



- Press **Shuffle** once for SHUFFLE DISC mode. Press **Shuffle** again to turn off the shuffle mode (SHUFFLE OFF).

🎵 **Note:** For information on changing CD-related source settings, see “CD Settings menu” on page 51.

🎵 **Note:** While playing an MP3 CD, pressing **Info** displays artist and title information on the media center display panel.

Listening to FM/AM radio



On the 3•2•1 remote, press **FM-AM**. If the system is off, the radio will turn on to the most recently selected station.

Tuning to a station

Use the following controls to tune to a radio station.



- Press **FM-AM** to switch between the FM and AM bands.



- Press **Tune ▲** to tune up the band. Press **Tune ▼** to tune down the band.



- Press **Seek ◀◀** to go to the previous station. Press **Seek ▶▶** to go to the next available station. Press and hold for rapid tuning. Release to stop at the next available station. To stop anytime, briefly press **Seek ◀◀** or **Seek ▶▶**. To begin seeking again without holding down the **Seek** button, briefly press **Seek ◀◀** or **Seek ▶▶** as soon as the first seek operation stops.

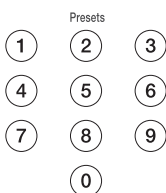

OR

- Press the number of a preset station on the remote.

Note: For information on changing FM/AM-related source settings, see “FM/AM Settings menu” on page 51.

Storing stations as presets

Using your 3•2•1 remote control, you can store up to 20 AM and 20 FM station presets. This enables you to tune to a favorite station quickly.

1. Tune to the preferred station.
2. Press **Enter** on the remote to store the station at the next available preset number.

OR

Enter a number on the remote using the numeric buttons. For numbers 1-9, press the single number button and hold it. For numbers 10-20, press the first number followed immediately by pressing and holding the second number.

The newly stored preset number appears briefly on the media center display.

Note: Storing a station to a preset number replaces any station previously stored to that preset.

Erasing a preset

1. Tune to the preset station.
2. Press and hold the **0** button on the remote until the media center display tells you that the preset is erased.

Using the uMusic® intelligent playback system

Before you can play stored music and use the uMusic® intelligent playback system, you need to store some CD tracks in your media center. To experience the impact of the uMusic playback system, you should start by storing 10 discs.

♪ **Note:** Your system is designed to store tracks of regular CDs only. It will not store MP3 tracks or the contents of DVDs. If an inappropriate disc type is in the disc tray when the Store button is pressed, the media center displays an error message to indicate that storage is not possible.

Storing CDs

1. To start, choose 10 of your favorite CDs.

Eject



2. Press **Eject** on the media center to open the disc tray.

3. Place an audio CD in the disc tray.

4. Press **Eject** again to close the tray.

Store



5. Press **Store** on the media center.

- Storing takes about 5 minutes per disc. While a CD is being stored, the media center display (Figure 24) shows you what percentage of the task is completed.
- To interrupt or stop storing at any time, press **Eject**. To resume storing the same disc, close the disc tray and press **Store** again.

Figure 24

Example of media center display while storing a CD

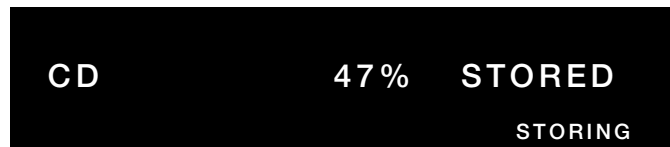

6. After AUDIO CD STORED appears on the media center display, open the disc tray, and remove the CD.
7. Repeat these steps for each CD.

Planning time to store your music

- Allow about 5 minutes per CD to copy the tracks.
- Storing 10 discs will take about 1 hour, including the time it takes to insert and remove them.
- After storing a CD, your system needs to process the tracks for efficient storage. If after storing several CDs the media center displays BUSY PROCESSING CDS, you will need to wait and allow the system to complete its process. Turning your system off will allow it to process CDs faster.
- For 10 CDs your system will need about 6 hours of processing time with the system turned off.
- If your CD collection is extensive, you should plan several separate sessions.



Playing stored music

- Press **Stored** on your remote to select the stored music source and turn on the system, if it is off. The uMusic® system will begin to play the stored music under the last-selected preset and in the last play mode used. Your media center displays information (Figure 25) about the track that is playing.

Figure 25

Example media center display of track information

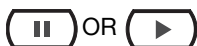
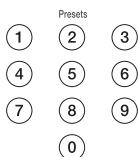
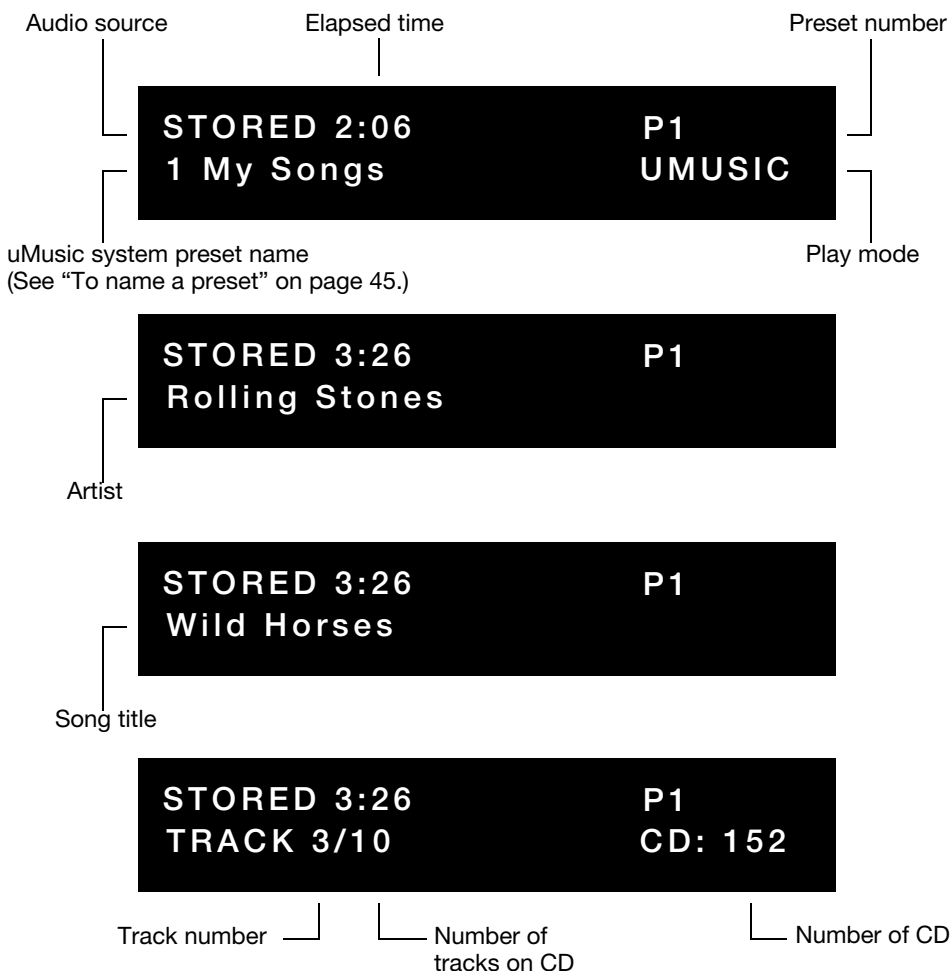

- If you want a different preset, press the corresponding preset number (1-9) on the remote.
- Press **Pause** to interrupt the current selection.
- Press **Pause** again, or press **Play** to resume playing a paused selection.



- Press **Stop** once to stop playing a selection. Pressing **Play** will continue the selection from where the track stopped.
- Press **Stop** twice. Pressing **Play** will start the selection from the beginning of the track.



- Press **Track ▲** to skip to another track.
- Press **Track ▼** to skip to a previous track.

🎵 **Note:** Pressing **Track ▲** or **Seek ►►** to skip a track registers a negative rating for that track. See "Rating your music" on page 43.



- Press **Seek ►►** once to skip to the next track.
- Within the first 2 seconds of play, press **Seek ◀◀** to skip to the previous track. After 2 seconds of play, press **Seek ◀◀** to skip to the beginning of the current track.
- Press and hold **Seek ◀◀** or **Seek ►►** to scan backward or forward through a track.



- Press **Info** to see information about the track that is playing on the media center and on your TV (Figure 26) if it is on.

Figure 26

Example of Info display



🎵 **Note:** For information on changing stored music-related source settings, see "Stored CD Settings menu" on page 51.

Rating your music

When you first start playing your stored music, the uMusic® system doesn't know what you like to hear the most, so the system starts by playing tracks from your entire music library. As you spend time listening to your music and rating each track, the system learns what you like to hear.



While a track is playing, you can tell the system if you like or dislike it:

- Press the **- Rating** button to tell the system you dislike the current track. The current track will stop and the system will select the next track. Pressing the **- Rating** button makes this track, and tracks like it, less likely to be played in the current preset.
- Press the **+ Rating** button to tell the system you really like the current track. The current track will continue to play. Pressing the **+ Rating** button makes this track, and tracks like it, more likely to be played in the current preset.

A rating is also registered when you skip a track or listen to a track all the way through. However, the effect of pressing a **Rating** button is stronger than either of these two actions.

You can also rate your stored music from within the Music Library. See “Rating stored music in the library display” on page 48.

Stored music play modes



- Press **uMusic** to return to the uMusic playback mode from the Encore, CD#, Playlist, or Whole CD play mode.



Encore

- Press **Encore** if the current track that is playing really captures your mood and you would like to hear other similar tracks from your stored music. After the other similar tracks are played, the uMusic playback system resumes.



CD #

- Press **CD#**, immediately followed by a CD number, to play one of your stored CDs. The CD number appears on the right side of the media center display while a CD is playing.



Playlist

- Press **Playlist** briefly to play the tracks that you have put into your playlist. For more information, see “Using the Playlist” on page 46.



Whole CD

- Press **Whole CD** to play all tracks, in order, of the CD that includes the track now playing. When the CD is finished playing, uMusic playback resumes.

Repeat and shuffle functions

Repeat and Shuffle functions only apply to CD#, Playlist, and Whole CD modes.



- Press **Shuffle** to play tracks in a random order. SHUFFLE is displayed on the media center.
- Press **Shuffle** again to turn off the shuffle function.



- Press **Repeat** to repeat a track. REPEAT TRACK is displayed on the media center.
- Press **Repeat** again to repeat the whole CD or playlist. REPEAT DISC is displayed on the media center.
- Press **Repeat** again to turn off the repeat function.
- To repeat a CD and play its tracks in random order, press **Shuffle** and then press **Repeat**. SHUFFLE REPEAT DISC is displayed on the media center.



Deleting stored tracks

If there is a track stored in the system that you will never want to play, you can permanently delete it from your stored music collection.

1. Press **System** on the remote control.
2. Select **Stored CDs** and press **Enter**.
3. Select **CD#** and press **Enter**.
4. Choose the number of the CD containing the track you want to delete and press **Enter**.
5. Select **Track** and press **Enter**.
6. Choose the name of the track you want to delete and press **Enter**.
7. Select **Track Action** and press **Enter**.
8. Choose **Delete Track** and press **Enter**.
9. After the confirmation, "Do you really want to permanently delete the track from the System," select **Yes** and press **Enter**.
10. Press **Exit** to leave the System menu.

Using uMusic® system presets

The uMusic® system can manage up to nine sets of preferences using presets. The nine presets can be used to establish music preferences for different family members or for special purposes or occasions. If you wish, you can enter a name for each preset to help you remember how it is used.

To select a uMusic preset

1. Press **Stored**.
2. Press **1** to **9** on the remote for the preset you want. A **P** followed by the preset number is displayed on the media center to verify your choice.

STORED 2:06 P3
TRACK 1/2 5

 **Note:** When you play the uMusic system for the first time, it automatically selects Preset 1.

3. The uMusic playback system starts to play music according to the likes and dislikes registered, if any, for this preset. You can continue to rate the music being played using the **+** and **-** Rating buttons.

Figure 27

Example music center display showing preset number



To name a preset

1. Press **System**.
2. Select **Media Center** options (Figure 28).

Figure 28

System menu – media center options

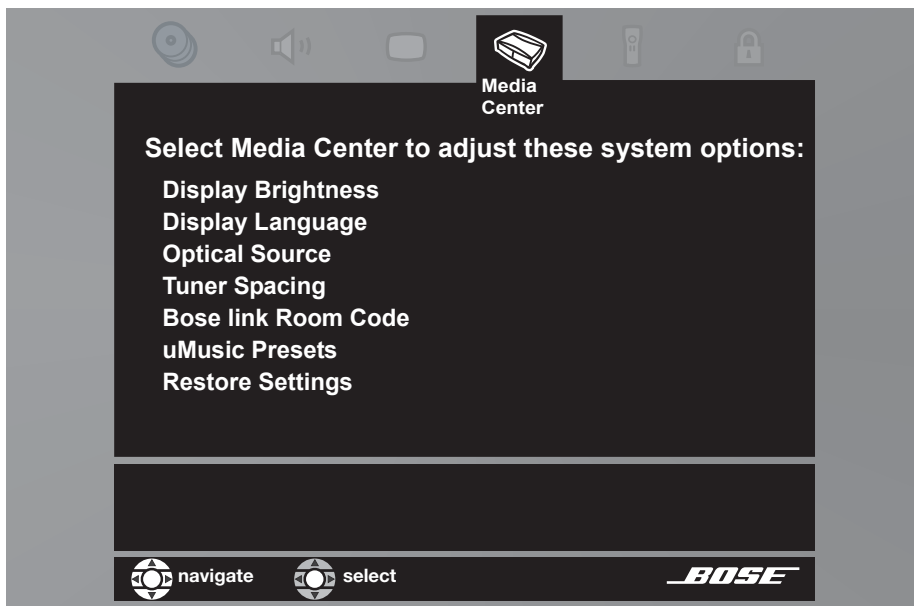

3. Select **uMusic® Preset** and press **Enter**.
4. Choose a preset and press **Enter**.
5. Select **uMusic Preset Action** and press **Enter**.
6. Select **Edit Name** and press **Enter**.
7. Using the edit screen, enter a name for the preset. See “Using the Edit Screen” on page 57 for instructions on using the edit screen.
8. Select **Done** at the top right corner of the screen and press **Enter**.
9. Press **Exit** to leave the System menu.



Using the Playlist

Using the Playlist feature, you can create a playlist of songs for a specific purpose, such as a birthday party or holiday gathering. The Playlist can contain as many tracks as you have stored in your media center.



To add the currently playing song to the playlist

Press and hold **Playlist** until ADDED TO PLAYLIST is displayed on the media center.

To listen to the Playlist

Press **Playlist** briefly. The tracks in the playlist play in order. Press the **uMusic**® button to leave the playlist and return to the uMusic playback mode.

To repeat a track or play the tracks in random order, see “Repeat and shuffle functions” on page 43.

To remove a track from the Playlist

While listening to the track in Playlist mode, press and hold **Playlist** until REMOVED is displayed on the media center. The track is removed from the playlist but not from the system.

To add songs to the Playlist by track, album, artist, or genre

1. Press **Library**.
2. Use the navigation buttons to browse through your stored music collection. Refer to “Finding stored music” on page 47.
3. Select the track, album, artist, or genre that you want to add.
4. Press and hold **Playlist** until TRACK>>PLAYLIST or ALBUM>>PLAYLIST is displayed on the media center. The Music Library screen on your TV also indicates that a track, or one or more albums, have been added to the Playlist.

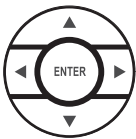

To remove all tracks from the Playlist

Before building a new playlist, you may find it easier to clear the playlist of all its songs.

1. Press **System**.
2. Select **Media Center** options. Press **Enter**.
3. Select **uMusic Preset Action**. Press **Enter**.
4. Select **Clear Playlist**. Press **Enter**.
5. Press **Exit** to leave the System menu.



Searching through your music library

Using the Library display, you can search through your music collection by genre, artist, album, or track.

Finding stored music

1. Press **Library**. The Music Library display (Figure 29) appears on your TV. Information also appears on the media center display (Figure 30).



Library

Figure 29

On-screen Music Library display

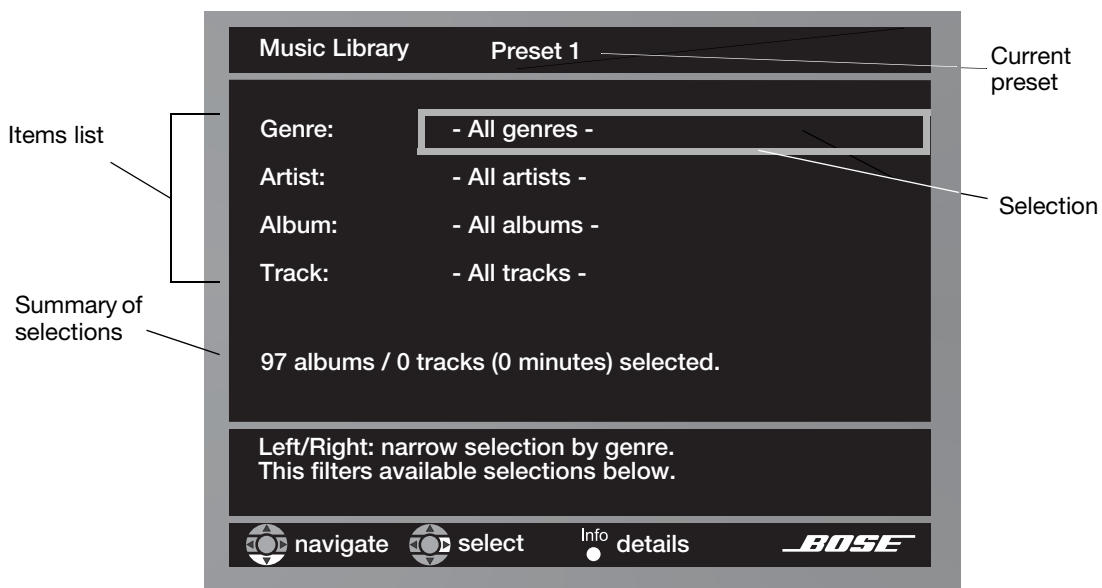

2. Use the navigation buttons on the remote to search for music by genre, artist, album, or track. Use the up/down arrows to select an item in the list. Use the left/right arrows to change the selection.
3. When you select a track or album you want to hear, press **Enter** to play it. When it is done, the uMusic® playback system will again start to select songs for you.
4. Press **Exit** to leave the Music Library.

Figure 30

Example of Library information on the media center display

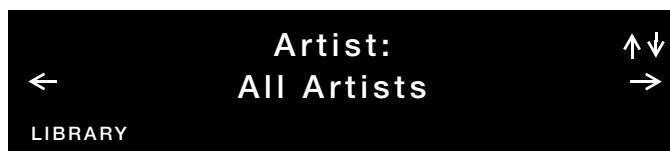

Rating stored music in the library display

You can register a rating for any stored music found in the library by genre, artist, album, or track. First find the item in the library display. While the item is selected, press the **- Rating** or **+ Rating** button on your remote. The display confirms your rating (Figure 31).

Figure 31

Example of rating indicator in the Music Library display

Selection you are rating

Music rating confirmation
(+ or - indicates how you rated the selection)

**Registering your system for music information updates**

When you store CDs, your system draws information from a built-in catalog of music information. This catalog includes 30 different characteristics about each CD, such as style, tone, related artists, key influences, and musicians. This is the information that makes the uMusic® intelligent playback system work.

Periodically, Bose issues a system update disc to make sure system owners have the most up-to-date music catalog. To receive future updates, be sure to register your system by mailing your completed product registration card to Bose. If indicated on your card, you may be able to register using the Internet.

Using the settings menus

While watching a video or listening to music on your system, you can make quick adjustments that will increase your enjoyment of the program. For that purpose, each source you use with this system has its own Settings menu with features appropriate to that source.

To view the settings menus

You can see the Settings menu for each source on your TV screen (Figure 32) and on the display panel of your media center (Figure 33).

1. Turn on your TV and select the correct TV input to view your 3•2•1 GSX system.
2. Press a source button on your 3•2•1 remote control.
3. Press **Settings** to display the Settings menu for the selected source.

If the list of menu items is too long for the screen, a small down or up arrow indicates that you need to scroll down or up to see other items.

4. Press **Exit** to leave the Settings menu.



Settings



Exit

Figure 32

Sample Settings menu on your TV screen

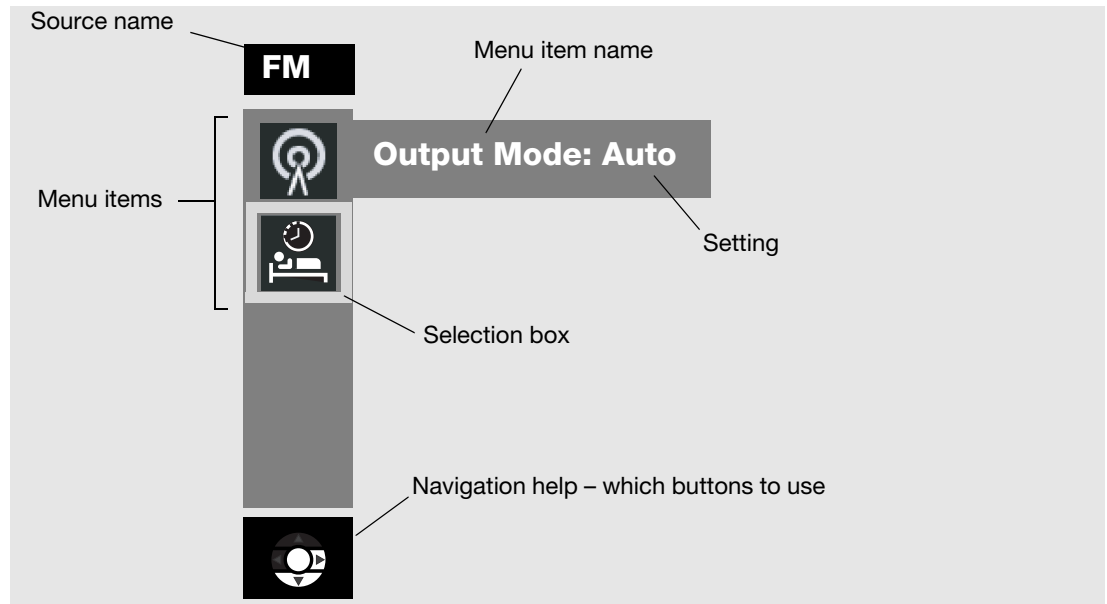

Note: Any changes made in the settings menu on your TV screen will also appear in the media center display panel.

On the media center display panel, menu items will scroll in and out of view as you press the up (▲) and down (▼) arrow buttons on the remote.

Figure 33

Sample Settings menu on the media center display

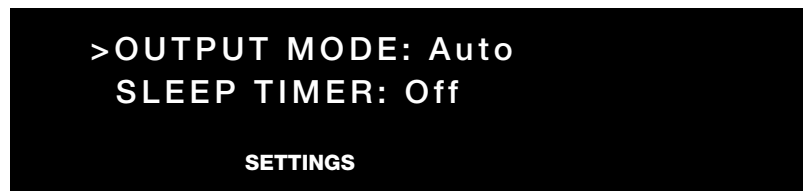

To make changes in the settings menus

Whether you use your TV screen or the media center display to change settings, the same instructions apply.

You can use the actions on page 49 to change back to the original (default) settings, too. Do that if you do not like the effect of a change you have made, or accidentally made a change you did not intend. The default settings for each source are shown in the menu tables on the following pages.

1. Turn on your TV and select the correct TV input to view your 3•2•1 GSX system.
2. Press a source button on your 3•2•1 remote control.
3. Press **Settings** to display the Settings menu for the selected source.
4. Using the down (▼) and up (▲) arrow buttons, select the menu item you want to change.
5. Press the right arrow (▶) button to select the menu item setting.
6. Press the up (▲) or down (▼) arrow button to change the setting.
7. Press **Enter** or the left arrow (◀) button to save the setting.
8. Press **Exit** to leave the Settings menu.



The progression in Figure 34 shows the output mode for the FM tuner being changed from Auto to Stereo.

Figure 34

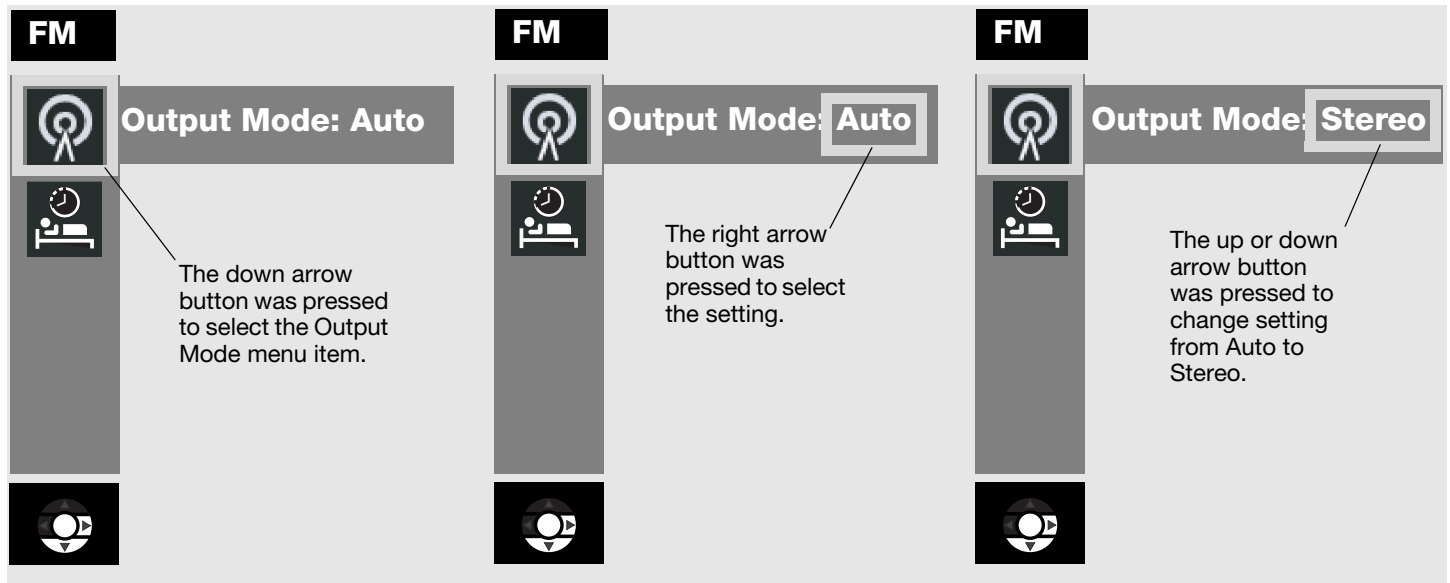

Changing the FM output mode setting



Note: You can restore all default settings by choosing **Restore Settings** in the Systems menu, under **Media Center** options. This reverts all source settings back to the factory default settings. It also changes the **Audio Processing** setting back to **Automatic** (found in the Systems menu under Audio options).



Stored CD Settings menu

To see the Stored CD Settings menu, press **Stored** on the remote. Then press **Settings**. Press **Exit** to remove the menu from the screen.

<i>Item</i>	<i>Name</i>	<i>Settings</i>	<i>Default</i>	<i>Description</i>
	uMusic® Preset	1 through 9, or names	1 (or last selected)	Indicates the current preset and allows you to change it.
	Play Mode (indicator)	Library, Encore, CD#, Playlist, Whole CD, Shuffle, Repeat	uMusic	Indicates the current uMusic play mode. Not adjustable in the Settings menu.
	Sleep Timer	10-90 minutes	Off	Sets system to turn off when the selected time elapses.



FM/AM Settings menu

To see the FM/AM Settings menu, press **FM•AM** on the remote. Then press **Settings**. Press **Exit** to remove the menu from the screen.

<i>Item</i>	<i>Name</i>	<i>Settings</i>	<i>Default</i>	<i>Description</i>
	Output Mode (FM only)	Auto, Stereo, Mono	Auto	Allows you to listen to stereo broadcasts in either stereo or mono output.
	RDS Info (FM only, and only on some systems)	Off, On	Off	Displays station and program information (as available from Radio Data System).
	Sleep Timer	Off, 10-90 minutes	Off	Turns the system off after the set time expires. Choose Off to deactivate the timer.











CD Settings menu

To see the CD Settings menu, press **CD•DVD** on the remote while playing an audio CD. Then press **Settings**. Press **Exit** to remove the menu from the screen.

<i>Item</i>	<i>Name</i>	<i>Settings</i>	<i>Default</i>	<i>Description</i>
	Track	__ of __		Allows you to select a track on the current disc.
	Sleep Timer	Off, 10-90 minutes	Off	Turns the system off after the set time expires. Choose Off to deactivate the timer.

DVD Settings menu

To see the DVD Settings menu, press **CD•DVD** on the remote while playing a DVD video disc. Then press **Settings**. Press **Exit** to remove the menu from the screen.





Item	Name	Settings	Default	Description
	Movie EQ*	On, Off	On	Optimizes the tonal balance for movies.
	Range Compression*	On, Off	On	Adjusts volume to maintain dialogue intelligibility. Keeps some sounds from overwhelming others.
	Mono Decoding*	On, Off	On	Engages Videostage® 5 mono decoding circuitry to convert mono sound (one-channel audio) into simulated surround sound.
	Time	_: _	0:00	Displays the elapsed time of the current DVD. Also, allows you to move to a new location in the movie by entering a new time.
	Title	__ of __		Selects a DVD title from the current disc, according to the number set. Some DVDs do not allow direct access to titles.
	Chapter	_____		Selects a DVD chapter from the current DVD movie, according to the number entered. Some DVDs do not allow direct access to chapters.
	Audio Track	Dependent on disc		Allows you to choose one of the available audio tracks on the current disc.
	Subtitle language	Dependent on disc		Allows you to choose one of the available subtitle languages (only if included on the disc).
	Camera Angle	1 of ____		Allows you to select one of the available camera angles (only if included on the disc).
	A-B Repeat	A, B		Repeats a segment of the DVD after the start and end points are defined. To begin: <ol style="list-style-type: none"> 1. Move backward or forward to the point in the DVD where you want the segment to start. 2. Press Enter. 3. Move to the point where you want it to end. 4. Press Enter. Repeats until you press the Settings button.
	Sleep Timer	Off, 10-90 minutes	Off	Turns the system off after the set time expires. Choose Off to deactivate the timer.

*Available only when Audio Processing is set to User Adjustable. See “Audio options” on page 59 for more information.

TV, CBL•SAT, and AUX Settings menu

The settings below affect programs on the TV, even when the source of the program is VCR, CBL/SAT, or AUX. There are no separate setting menus for these sources.

Movie EQ, Range Compression and Mono Decoding appear in the menu only if **Audio Processing** is set to **User Adjustable**. Audio Processing can be found in the System menu under Audio options.

<i>Item</i>	<i>Name</i>	<i>Settings</i>	<i>Default</i>	<i>Description</i>
	Movie EQ*	On, Off	On	Optimizes the tonal balance for movies.
	Range Compression*	On, Off	On	Adjusts volume to maintain dialogue intelligibility. Keeps some sounds from overwhelming others.
	Mono Decoding*	On, Off	On	Engages Videostage® 5 mono decoding circuitry to convert mono sound (one-channel audio) into simulated surround sound.
	Dolby Digital 1+1**	1, 2, Both	1	Plays audio content of selected soundtrack(s). The content of the second sound-track may be a second language, for example.
	Sleep Timer	Off, 10-90 minutes	Off	Turns the system off after the set time expires. Choose Off to deactivate the timer.

*Available only when Audio Processing is set to User Adjustable. See "Audio options" on page 59 for more information.

**Available only when a Dolby Digital 1+1 signal is detected.

CHANGING SYSTEM OPTIONS

Using the System menu

Changes to system options are typically made only once. If your system operates as you want it to, there may be no need for any changes. In some cases, however, changes are required to make the system fully compatible with the installation options you have chosen.

To change System menu options

Unlike the source settings menus, the System menu only appears on your TV screen.

1. Turn on your TV and select the correct TV input to view your 3•2•1 GSX system.
2. Press the **System** button on your 3•2•1 remote control. The System menu (Figure 35) appears on your TV screen.



Note: Entering the System menu causes any DVD or VCD that is playing to pause.

Figure 35

System menu example

Categories of options

List of system options for the selected category

Navigation help – which remote control buttons to use

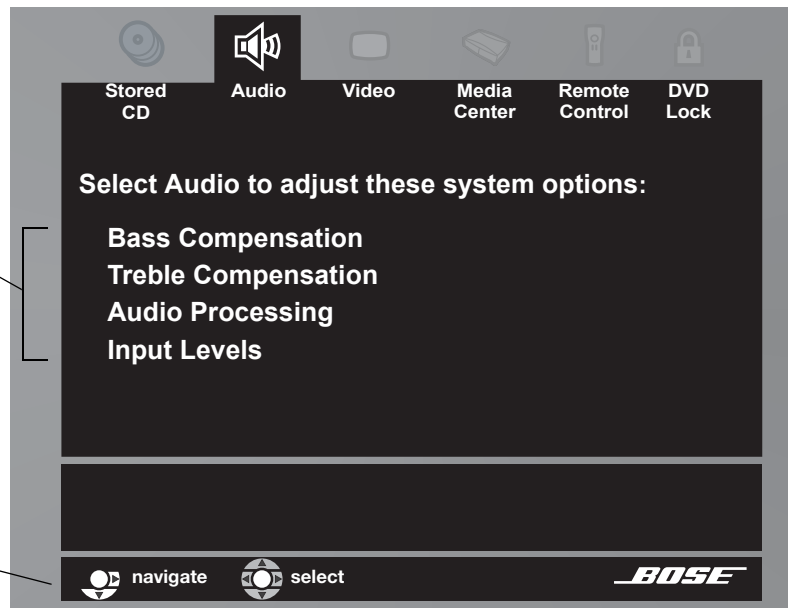

3. Using the right (▶) and left (◀) arrow buttons, highlight one of the option categories (Stored CD, Audio, Video, Media Center, Remote Control, or DVD Lock).
4. Press **Enter** or the down (▼) arrow to select the option category.
5. Using the down (▼) and up (▲) arrow buttons, select the system option to change.
6. Press the right arrow (▶) button to see the system option settings.
7. Press the up (▲) or down (▼) arrow button to change the setting.
8. Press **Enter** or the left arrow (◀) button to save the setting.
9. Press **Exit** to leave the System menu.



Stored CD options

Press **System** on the remote control. A preview of Stored CD features is displayed. Press the down arrow button to move into an active display of submenus.

🎵 **Note:** This choice is available from the System menu only when music from at least one CD has been stored in the system. For information on storing your music, refer to “Storing CDs” on page 40.

Figure 36

Stored CD preview

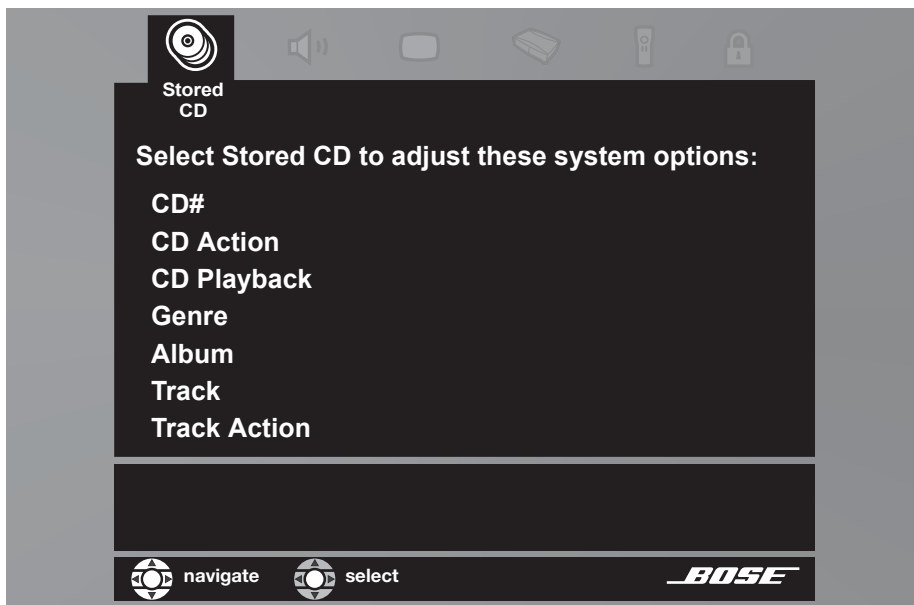

Stored CD Options	Settings	Description
CD# (Indicator only)	1 [default] or selected CD number	Shows the settings for the CD with that number in the system. Changes when the CD selection changes; cannot be edited.
CD Action	Reload CD information [default] Delete CD	Replaces user edits with database information. Requires confirmation. Then removes all information related to this CD.
CD Playback	Automatic [default] Link all tracks Don't link all tracks	Plays linked tracks of a CD in order, such as movements of a symphony. Tracks play together and in order only. Tracks do not always play in order and together.

Stored CD Options	Settings	Description
Genre	Rock/Pop, Classical, Jazz, Electronica, World, Latin, Country, Hip Hop/Rap, Vocal Music, Gospel/Religious, Blues, Soundtrack, Folk/Bluegrass, New Age, Reggae, Easy Listening, Children, Spoken/Comedy, Holiday, Other, Unlabeled	Identifies the type of music on the CD. Reclassifies the CD as the selected music genre.
Album	<i>Specific to the CD</i>	Displays an editing screen** on your TV, which allows you to change album information.
Artist*	<i>Specific to the CD</i>	Displays an editing screen** on your TV, which allows you to change artist information.
File Artist As*	<i>Specific to the CD</i>	Displays an editing screen** on your TV, which allows you to change the way an artist's name is listed.
Track	<i>Specific to the CD</i>	Allows you to select a track on the CD.
Track Action	Edit [default] Delete Track	Selecting Edit displays an editing screen on your TV. Displays a message asking you to confirm your selection. Upon confirmation, the current track and all track information is deleted.

*Does not appear in every menu.

**See "Using the Edit Screen" on page 57.

Using the Edit Screen

The Edit Screen (Figure 37) enables you to change or replace music information provided by the system. It appears when you select a menu item that can be edited from the Stored CD options (page 55) or the Library menu (page 47).

Figure 37

Edit Screen example

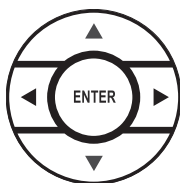
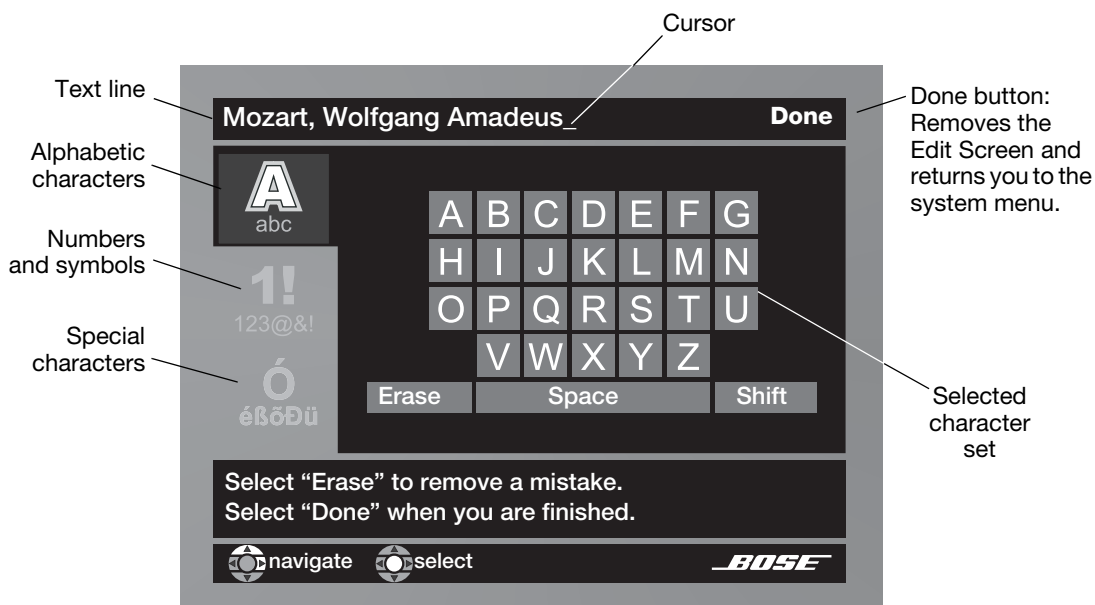

When you select a menu item that can be edited, the text appears in the text line of the Edit Screen. You can add to it or enter new text by selecting characters from the alphabetic, numeric, or special character sets. Use the remote control up, down, left and right arrows to select a character and press **Enter** to write it in the text line. When you are finished editing, select the **Done** button and press **Enter** to remove the Edit Screen.

To remove existing characters from the text line:

Characters are removed from right to left starting at the cursor.

1. Select **Erase**.
2. Press **Enter** to remove the last character in the text line.
3. Press **Enter** as often as needed to remove additional characters in that line.

To enter new text or add to existing text:

New characters are added starting at the cursor.

1. Move to a character and press **Enter**.
2. Move to the next character and press **Enter**.

To enter a space between words:

Spaces are entered to the right of the last character in the text line.

1. Select **Space** and press **Enter**.
2. Select the first character of your next word and press **Enter**.

To enter a capital letter:

The first letter of a new line of text is automatically capitalized. Lower case characters are entered after that unless you use the Shift function.

1. Select **Shift** and press **Enter**. Notice that the alphabetic character set is now all capital letters.
2. Select the next character and press **Enter**.
3. Select **Shift** and press **Enter** again if you want the next entered character to be lower case.

To enter a number or symbol:

1. Select the number and symbols character set.
2. Select the number or symbol you want and press **Enter**.

To enter a non-English special character:

1. Select the special characters set.
2. Select the special character(s) you want and press **Enter**.

To save the text:

- Select **Done** and press **Enter**.

To undo all edits you've made:

To undo changes you made to CD information, you can replace your changes with the original music information that came stored in your system.

1. Press **System** on the remote.
2. Select **CD Action**.
3. Select **Reload CD information** and press **Enter**.
4. Press **Exit**.

Audio options

The audio options affect the way the system sounds in your home.

Note: Listening to an audio source while you change audio options can be helpful. Some changes will be immediately noticeable and therefore useful in fine tuning your selections.

Figure 38

Audio system options

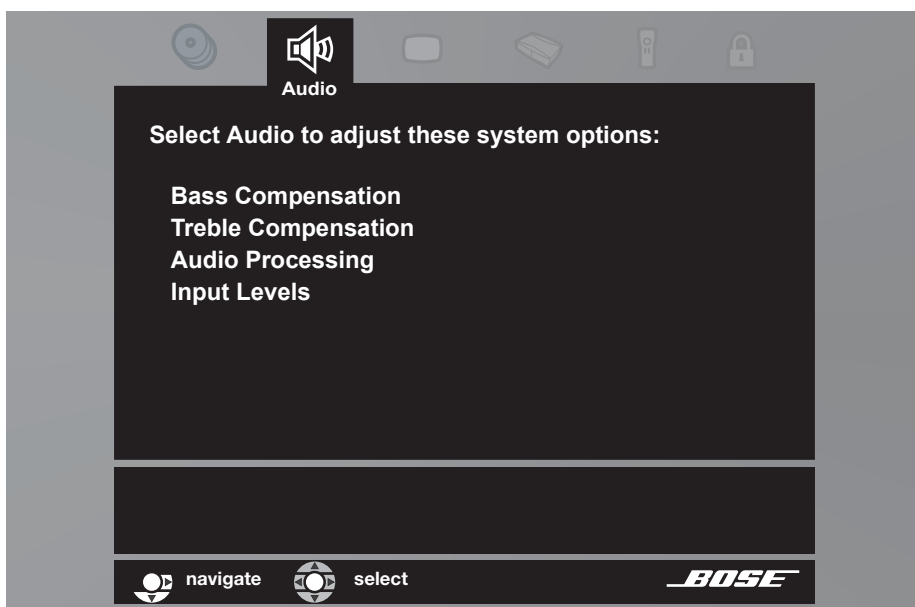

Audio Options	Settings	Description
Bass Compensation	0 [default] -14 to +14	Normal low-frequency reproduction. Decreased (-) or increased (+) low-frequency reproduction.
Treble Compensation	0 [default] -14 to +14	Normal high-frequency reproduction. Decreased (-) or increased (+) high-frequency reproduction.
Audio Processing	Automatic [default] User Adjustable	Standard Bose® processing applied. Processing options (Movie EQ, Range Compression, Mono Decoding) available in Source Settings menus.
Input Levels: TV Analog Input Level TV Digital Input Level CBL/SAT Analog Input Level CBL/SAT Digital Input Level AUX Analog Input Level AUX Digital Input Level	Normal [default] -6, -3, +3, +6	Standard signal level (loudness). Decreases or increases signal level (adjustable to match the levels of other audio devices). Note: You may want to adjust the input levels of external audio devices so they match the system's internal FM and CD levels.

Video options

The video options affect the way the picture looks on your TV.

Figure 39

Video system options



Video Options	Settings	Description
TV Aspect Ratio	Normal [default] Widescreen	4:3 ratio screen display. 16:9 ratio widescreen display.
Widescreen DVDs	Unmodified [default] Modified	DVD video does not reformat automatically. DVD reformats, as needed, to fit a 4:3 TV screen.
Video Connector	Composite + S-Video [default] Component	A <i>read-only</i> line that identifies the type of video connection made on the back panel of the media center.
Video Black Level	Normal [default] Extended	Screen black level generally appropriate for TVs. Increases screen black level, appropriate for certain TVs.
TV Video Format	NTSC (US) [default] PAL (EUROPE) (MULTISTANDARD)	Correct for NTSC (U.S. standard) monitors. Correct for PAL (European standard) monitors. Only for a TV that supports multiple formats (NTSC and PAL).
Progressive Scan*	Off [default] On	Screen image repaints in standard style. Screen image repaints in advanced style (if available on the TV).

*Appears only when your TV is connected to the media center using a component video connection.

Media center options

The media center options affect the general operation of the system.

Figure 40

Media Center system options

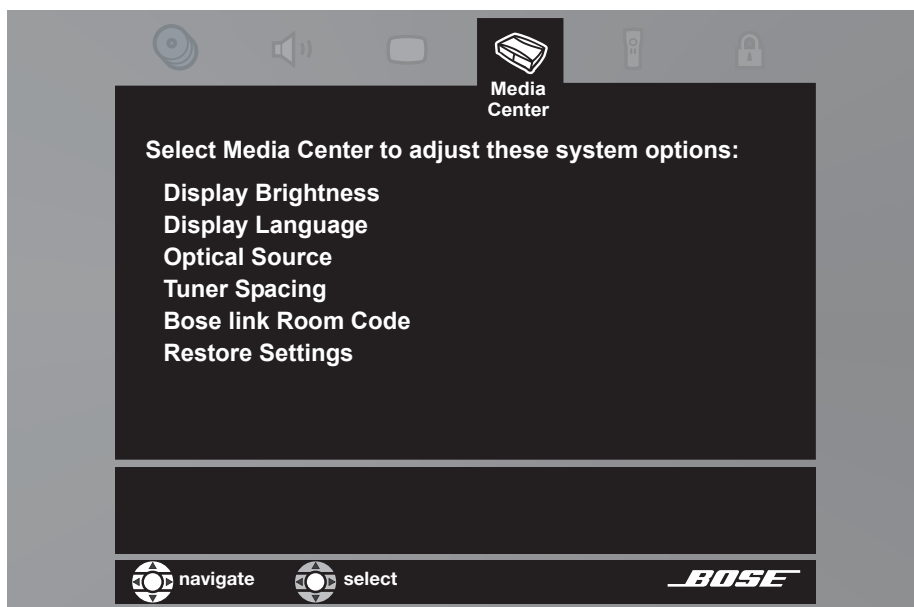

Media Center Options	Settings	Description
Display Brightness	4 [default] 1 (darkest) to 4 (brightest)	Media center display lights with a mid-range brightness. Darkens or lightens the media center display.
Display Language	English [default] Dansk, Deutsch, Espanol, Francais, Italiano, Nederlands, Svenska	On-screen display menus appear in the selected language.
Optical Source	None [default] TV, CBL/SAT, AUX	No digital signal received via optical cable. Digital signal received via optical cable for selected source.
Tuner Spacing	US [default] European	Channel spacing for AM/FM radio stations set to selected region standard.
uMusic® Preset	1 [default] 2, 3, 4, 5, 6, 7, 8, 9	The selected preset to which a uMusic Preset Action is applied.
uMusic Preset Action	Edit name Clear playlist Clear ratings	Opens an editing screen for naming or renaming the selected uMusic Preset. Removes all tracks from the system playlist. Removes all stored ratings associated with the selected uMusic Preset.
Bose® link Room Code*	B [default] C, D, E, F, G, H, I, J, K, L, M, N, or O	Assigns a room code to your 3•2•1 GSX system when it is connected to a Bose® link source.
Restore Settings	No Yes	Maintains current system settings. Reverts system settings back to factory defaults.

*Appears only when a Bose® link source is connected.

Remote control options

The Remote Control options help you set up your remote to control other audio devices that are connected to your system.

Figure 41

Remote Control system options



Remote Control Options	Settings	Description
TV Brand	Brand name	Provides a list of TV brands for the 3•2•1 remote control to operate.
TV Device Code	Code number	Provides a list of available device codes for the selected TV brand.
CBL•SAT Device	Cable, Cable/DVR, Satellite, Satellite/DVR, HDTV tuner	Identifies which of two devices is connected to the CBL-SAT input.
CBL•SAT Brand	Brand name	Provides a list of cable/satellite box brands for the 3•2•1 remote control to operate.
CBL•SAT Device Code	Code number	Provides a list of available device codes for the selected cable/satellite box brand.
AUX Device	TV/DVD, DVD/DVR, DVD/DVD recorder, Satellite/DVR, Cable/DVR, DVR, VCR	Identifies which of two devices is connected to the AUX input.
AUX Brand	Brand name	Provides a list of VCR/PVR brands for the 3•2•1 remote control to operate.
AUX Device Code	Code number	Provides a list of available device codes for the selected VCR/PVR brand.

- ♪ **Note:** To find the brand and device codes for each component that can be connected to, and controlled by, the 3•2•1 GSX system, see "Device Codes" on page A-1.
- ♪ **Note:** After programming your remote to control external audio/video devices from the System menu, press the System button once to continue navigating the System menu.

DVD Lock options

The DVD Lock options allow you to restrict viewing of DVD videos with certain ratings. To activate this feature, you need to set a level of restriction and establish a password in the DVD Lock section of the System menu.

Figure 42

DVD Lock system options

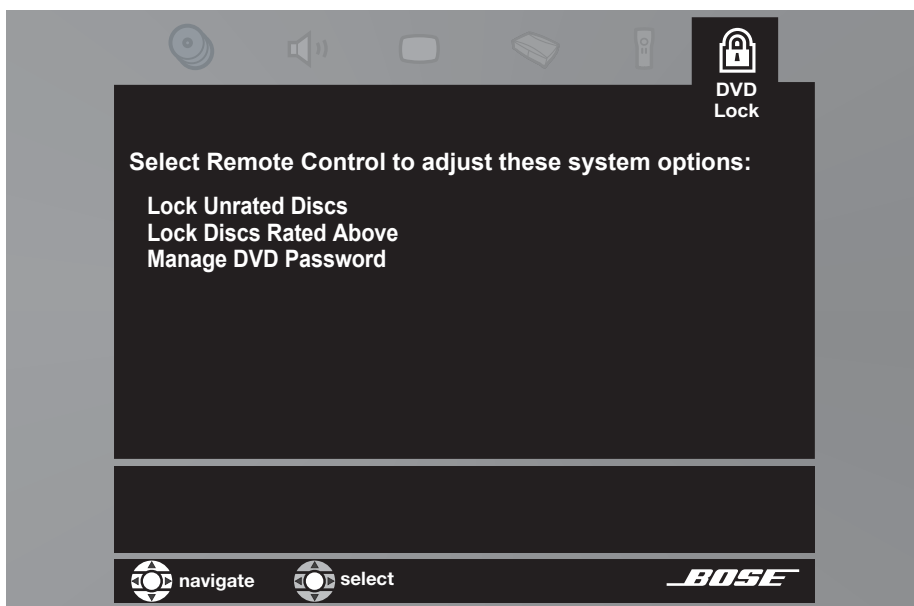

DVD Lock Options	Settings	Description
Lock Unrated Discs	Off On	No restriction applies to unrated DVD movies. Restricts viewing access to unrated titles when password is set.
Lock Discs Rated Above	1 to 8	Helps prevent viewing discs above the selected number when a password is created.
Manage DVD Password	----	Establishes a new four-number code to restrict access to movies with certain ratings.

Setting a password and restriction level

Your password will help prevent unauthorized viewing of DVD videos that have a higher rating than your restriction level. There are eight levels to choose from, matched to movie ratings set by the Motion Picture Association of America (MPAA). See “Motion Picture Association of America (MPAA) rating system” on page 64.

1. Turn on your TV and select the correct TV input to view your 3•2•1 GSX system.
2. Press the **System** button on your 3•2•1 remote control.
3. Using the right (▶) and left (◀) arrow buttons, highlight the DVD Lock option.
4. Press **Enter** or the down (▼) arrow button.



Note: If you are using the DVD Lock option for the first time, enter a four-digit password. Then enter it again to confirm.



5. Enter your four-digit password.
6. Using the down (▼) button, scroll down to Lock Discs Rated Above.
7. Press the right arrow (▶) button to see the available settings.
8. Press the up (▲) or down (▼) arrow button to find the rating you want.
9. Press **Enter** or the left arrow (◀) button to save the setting.
10. Press **Exit** to dismiss the Settings menu.

Motion Picture Association of America (MPAA) rating system

<i>Parental Control Setting</i>	<i>MPAA Rating</i>	<i>Audience Restriction</i>
8		None
7	NC-17	Adult audiences
6	R	Mature audiences
5		Mature teenage audiences
4	PG-13	Teenage audiences
3	PG	Mature young audiences
2		Most audiences
1	G	General

Example: Choosing a Parental Control Setting of 4 restricts access to videos rated above PG-13. Videos with ratings above that may be viewed only after entering the password. Your password also helps prevent others from changing the restriction level setting without permission.

Cleaning

Cleaning the media center

- Use only a soft, dry cloth to clean the outside surfaces of the media center.
- Do not use any sprays near the system. Do not use any solvents, chemicals, or cleaning solutions containing alcohol, ammonia, or abrasives.
- Do not allow liquids to spill into any openings.

Cleaning the speakers

- Clean the surface of your speakers with a soft, damp cloth. You can use an ammonia-free window cleaner on a soft cloth to maintain the finish.
- Do not use any sprays near the speakers. Do not use any solvents, chemicals, or cleaning solutions containing alcohol, ammonia, or abrasives.
- Do not allow liquids to spill into any openings.

Cleaning discs

- Handle discs by their edges to prevent fingerprints and scratches (Figure 43a).
- To remove stains or fingerprints from the surface of a disc, use a soft and dry lint-free cloth. Wipe in straight movements from the center of the disc to the outside (Figure 43b). Do not use any chemical products; they can damage the disc.
- Do not use a circular motion to clean (Figure 43c).
- Do not write on or attach labels to the surface of a disc.
- To minimize exposure to dust and dirt, return discs to their cases after use. Store each disc in its case, away from direct sunlight, high temperatures, and humidity.

Figure 43

Disc care

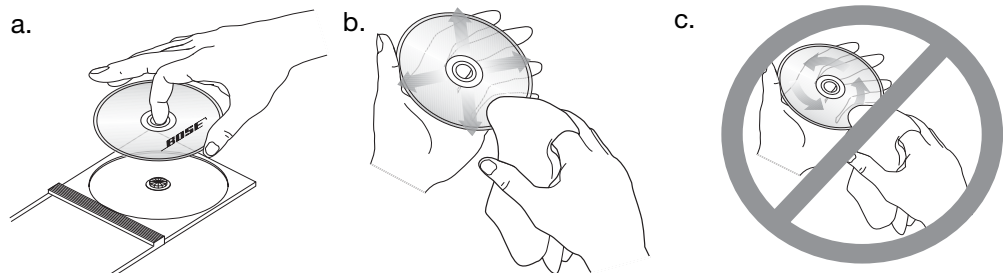

Replacing the remote control batteries



CAUTION: Please dispose of used batteries properly, following any local regulations. Do not incinerate.

- Slide open the battery compartment (Figure 44).
- Notice the polarity markings (+ and -) inside the compartment and install the batteries accordingly. Be sure to replace both batteries.
- Slide the battery compartment cover back into place.

Figure 44

Putting in the batteries

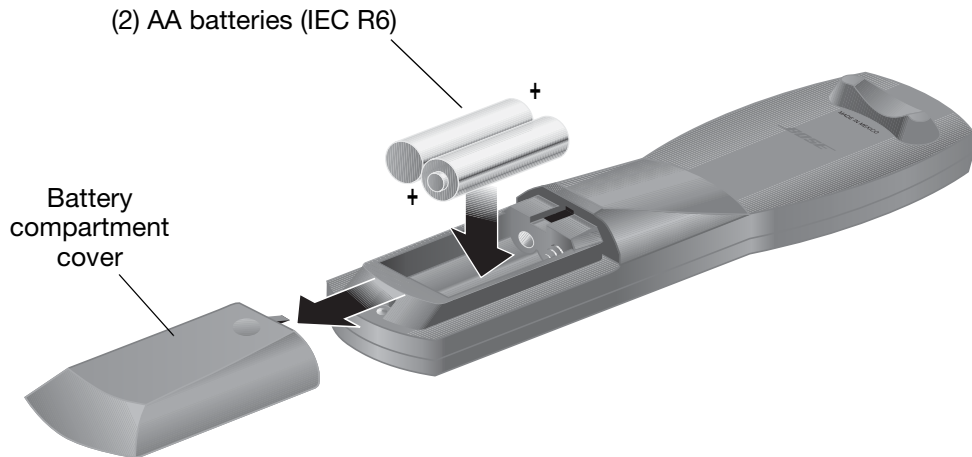

Accessories

The Bose® 3•2•1 GSX system shelf speakers are compatible with Bose mounting accessories, including the UB-20 wall brackets, UFS-20 floor stands, and UTS-20 table stands (Figure 45). Bose also offers cable adapters for use in running speaker cable through walls.

For further information or to order the mounting brackets, stands, or cable adapters, contact your Bose dealer or Bose Corporation directly. Refer to the address sheet included in the shipping carton.

Figure 45

Speaker accessories

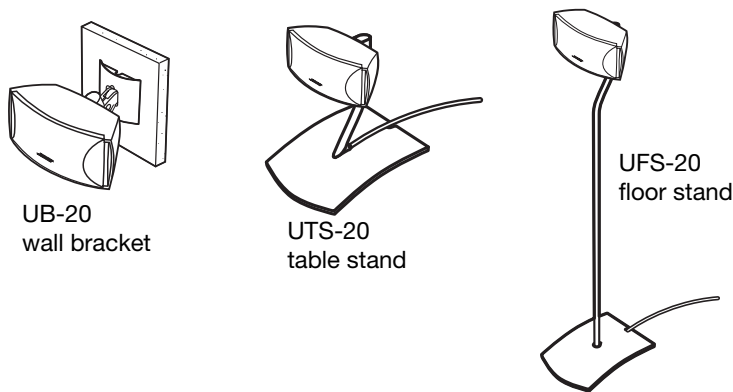

Troubleshooting table

Problem	What to do
System doesn't do anything	<ul style="list-style-type: none"> • Make sure the unit is turned on. Try pressing the remote On-Off button and the media center On-Off button. • Make sure the Acoustimass® module cable is properly connected to the media center and the Acoustimass module. • Make sure the power cord is inserted securely into the Acoustimass module and plugged firmly into an operating AC wall outlet. • Be sure to select a source (CD/DVD, AM/FM, etc.). • Unplug the Acoustimass module power cord from the outlet for one minute, then reconnect it. This allows the unit to reset itself. After reconnecting the power cord, wait for the message "BOSE 3•2•1" to appear on the media center display.
Disc won't eject	<ul style="list-style-type: none"> • Turn off the unit. • Unplug the Acoustimass module power cord from the outlet for one minute, then reconnect it. This allows the unit to reset itself. • Before powering on, press and hold Eject on the media center.
No sound	<ul style="list-style-type: none"> • Increase the volume. • Check to see if MUTE is lit on the display. If it is, press the Mute button on the remote control to unmute the sound. • Be sure to select the correct source for the desired input. • On the remote, press the button for the source you want to hear. If you previously selected a source by pressing the Source button on the media center, you cannot control the new source with the remote until you press the button for this new source on the remote. • Make sure the Acoustimass module cable and speaker cable are firmly seated in their respective jacks and the multi-pin connector on the other end is firmly seated in the Acoustimass module jack. • Check speaker connections. • Turn the media center off for 10 seconds, then on again. • Check the connections for any external audio devices. • Be sure the disc is placed correctly, label-side up, in the CD tray. • Connect the FM and AM antennas. • Unplug the Acoustimass module power cord from the outlet for one minute, then reconnect it. This allows the unit to reset itself. • If you are using an optical digital audio connection, make sure that the optical jack is correctly assigned in the System menu. • Make sure the volume is turned up on the TV. • Check input level settings for each connected device in the System menu.
Sound, but no picture	<ul style="list-style-type: none"> • Make sure the TV is on. • When playing a DVD or other video source, make sure the TV is set to the correct video input.
Remote control is inconsistent or does not work	<ul style="list-style-type: none"> • Check batteries and their polarity (+ and –). See "Replacing the remote control batteries" on page 66. • On the remote, press the button for the source you want to hear. If you previously selected a source by pressing the Source button on the media center, you cannot control the new source with the remote until you press the button for this new source on the remote. • Point the remote control at the media center.

Problem	What to do
Radio does not work or has poor reception	<ul style="list-style-type: none"> • Make sure antennas are connected properly. • Move AM antenna at least 20 inches (50 cm) from the media center. • Adjust antenna position to improve reception. • Make sure the AM antenna is in the upright position. • Move antennas farther from TV or other electronic equipment. • You may be in an area of weak signal coverage.
DVD or CD does not play	<ul style="list-style-type: none"> • Check to see if the Play symbol in the display is lit. • After pressing the CD•DVD button, wait a few seconds before pressing Play. • Make sure the disc is properly inserted (label-side up). • Eject the disc and try loading it again. • There may be dirt or dust on the disc. Clean the disc. See “Cleaning discs” on page 65. • The disc may be defective. Try another disc. • Make sure region codes for both the DVD and player match. See “Checking for region code compatibility” on page 5.
FM sound is distorted	<ul style="list-style-type: none"> • Adjust antenna position to reduce interference.
Sound is distorted	<ul style="list-style-type: none"> • Make sure speaker cables are not damaged and the connections are secure. • Reduce the output level from any external audio devices connected to the music center. • Reduce the input level setting for the connected device in the System menu.
Picture is black and white or rolling	<ul style="list-style-type: none"> • Check the video cable connections. • Check the Video Format setting and change to appropriate setting (NTSC or PAL). See “Video options” on page 60.
Forgot your password	<ul style="list-style-type: none"> • Enter the password 2673 to unlock DVD access.
“NO LABEL” appears on the media center display when using the Stored CD source	<ul style="list-style-type: none"> • The uMusic® system uses a catalog of music information to identify and classify the CDs you store. A recent CD release might not be in the catalog. To receive music information updates, be sure to register your system. • Manually enter information using the edit screen (page 57).
“BUSY PROCESSING CDs” appears on the media center display and it won’t let you store any more CDs	<ul style="list-style-type: none"> • When you store a CD, the tracks are first placed in a holding area, which can hold up to 10 CDs. This message appears if this holding area is full. Wait 30 minutes and try again.

Customer service

For additional help in solving problems, contact Bose® Customer Service. Refer to the address list included in the carton.

Power rating

USA/Canada: 120V ~ 60Hz 300W

International: 220-240V ~ 50/60Hz 300W

Dual voltage: 115/230V ~ 50/60Hz 300W

Audio inputs

AUX – Left, Right (analog); **D** (digital)

CBL-SAT – L, R (analog); **D** (digital)

TV – L, R (analog); **D** (digital)

Optical – SPDIF digital, mapped to input

Audio outputs

Acoustimass® Module – SPDIF

Video inputs

C (composite) – NTSC or PAL format

S-Video

Video outputs

C (composite) – NTSC or PAL format

S-Video

Component Y, Pb, Pr

Antennas

FM 75Ω – external FM antenna

AM – external AM antenna

Maximum ambient temperature

104°F (45°C)

Dimensions

Media center: 3¼"H x 13¾"W x 10"D
(8.3 cm x 34.9 cm x 25.4 cm)

Remote control: 1⅛"H x 2½"W x 9"D
(3.0 cm x 6.5 cm x 22.9 cm)

3•2•1 GSX speakers: 2½"H x 5½"W x 4"D
(6.4 cm x 14 cm x 10.5 cm)

Acoustimass module: 14½"H x 8¾"W x 19⅛"D
(36.7 cm x 22.2 cm x 48.5 cm)

Weights

Media center: 6.7 lb (3.0 kg)

GSX speakers: 1 lb (.45 kg) each

Acoustimass module: 23.3 lb (10.6 kg)

Finish

Media center: polymer

Speakers: polymer

Acoustimass module: polymer

END USER LICENSE AGREEMENT

IMPORTANT: READ CAREFULLY: This End User License Agreement (“EULA”) is a legal agreement between you, the End User (“End User” or “You”), and Bose Corporation (“Bose”) governing your use of the technology and software and data and data content belonging to Bose, its vendors and licensors (“Technology”), that is contained in this audio/video device (“System”). By tearing open the protective wrapping on this System, you are agreeing to be bound by the terms of this EULA. In the event you disagree with any of the terms contained herein, **DO NOT UNWRAP THIS SYSTEM.** Return the sealed System to Bose Corporation for a full refund.

Copyright laws and international copyright treaties, as well as other intellectual property laws and treaties protect the Technology contained within this System. The Technology is being licensed, not sold. This EULA grants you the right to use the Technology only on this Bose System. You may NOT transfer, lend, distribute, prepare derivative works, reverse engineer, de-compile, or disassemble the Technology, except and only to the extent that applicable law expressly permits such activity. You agree that you will use the Technology and the System solely for your own personal non-commercial use.

The Technology contains software that allows You to obtain vendor-supplied music-related information, including name, artist, track, and title information (“Data”). You may use Data only by means of the intended End User functions of the Technology. You agree not to assign, copy, transfer or transmit such Data to any third party. **YOU AGREE NOT TO USE OR EXPLOIT DATA EXCEPT AS EXPRESSLY PERMITTED HEREIN.**

You agree that your non-exclusive license to use the Technology will terminate if you violate these restrictions. If your license terminates, you agree to cease any and all use of the Technology or Data. Bose, its vendors and licensors reserve all rights in the Technology, including all ownership rights. You agree that the vendors and licensors of Bose may enforce their rights under this Agreement directly in their own name.

Bose warrants this System in accordance with the provisions of the warranty card delivered with this System. EXCEPT AS EXPRESSLY SET FORTH THEREIN, BOSE, ITS VENDORS, AND ITS LICENSORS HEREBY DISCLAIM ALL WARRANTIES, EXPRESS, IMPLIED, AND STATUTORY, IN CONNECTION WITH THE TECHNOLOGY, INCLUDING WITHOUT LIMITATION, THE IMPLIED WARRANTIES OF MERCHANTABILITY, NON-INFRINGEMENT OF THIRD PARTY RIGHTS, AND FITNESS FOR A PARTICULAR PURPOSE. IN NO EVENT WILL BOSE, ITS VENDORS, OR ITS LICENSORS BE LIABLE FOR ANY INDIRECT, SPECIAL, INCIDENTAL, OR CONSEQUENTIAL DAMAGES ARISING OUT OF THE USE OR INABILITY TO USE THE TECHNOLOGY. IN NO EVENT SHALL BOSE BE LIABLE FOR ANY DAMAGES.

None of the Technology shall be exported or re-exported in violation of any export provisions of the United States or any other applicable jurisdiction. Any attempt to sublicense, assign or transfer any of the rights, duties or obligations hereunder shall be void. This Agreement shall be governed by and interpreted under the laws of the Commonwealth of Massachusetts, without regard to its conflicts of law provisions.

YOU ACKNOWLEDGE THAT YOU HAVE READ AND UNDERSTAND THIS AGREEMENT AND AGREE TO BE BOUND BY ITS TERMS. YOU FURTHER AGREE THAT THIS AGREEMENT IS THE COMPLETE AND EXCLUSIVE STATEMENT OF THE AGREEMENT BETWEEN YOU AND BOSE AND SUPERCEDES ANY PROPOSAL OR PRIOR AGREEMENT, ORAL OR WRITTEN, AND ANY OTHER COMMUNICATIONS RELATING TO THE SUBJECT MATTER OF THIS AGREEMENT.

Finding the right device codes

Using the right device codes, you can set up your new universal remote to control the video devices you want to use with your speaker system. For the remote setup procedure, see your owner's guide.

To find available codes for a device, search the listing under the appropriate device type heading.

If you have a combination device, such as a TV with a built-in DVD or VCR device, first search the "COMBINATION" listings starting on page 20. If you cannot find a valid code there, then search the listings for individual device types. Keep in mind that combination devices may use the same code for each device in the unit.

TV	A-2
Television	
CBL	A-8
Cable box	
SAT	A-9
Satellite receiver	
DVD	A-11
VCR	A-15
VCR	
DVR	A-19
Digital Video Recorder	
HDTV	A-19
HDTV Decoder	
Combination	A-20
TV/VCR	A-20
TV/VCR combination	
TV/DVD	A-20
TV/DVD combination	
TV/VCR/DVD	A-20
TV/VCR/DVD combination	
VCR/DVD	A-20
VCR/DVD combination	
CBL/DVR	A-21
Cable/DVR combination	
SAT/DVR	A-21
Satellite/DVR combination	
DVD/DVR	A-21
DVD/DVR combination	

TV

Television

A-Mark 0003
 Abex 0032
 Addison 0092, 0108, 0653, 1150
 Admiral 0093, 0463
 Advent 0761, 0783, 0815, 0817, 0842
 Adventura 0046
 Adyson 0032, 0217
 AEA 0037
 AEG 0606
 Agashi 0217
 Aiko 0037, 0092, 0217
 Aim 0208, 0606, 0706
 Aiwa 0701, 1180
 Akai 1537, 0812, 0745, 0714, 0708, 0706, 0702, 0698, 0672, 0631, 0606, 0602, 0556, 0548, 0480, 0217, 0208, 0178, 0060, 0037, 0030
 Akiba 0037, 0282
 Akira 0037, 0556
 Akito 0037
 Akura 0037, 0282, 0714, 1037
 Alaron 0179
 Alba 0037, 0443, 0714, 1037
 Albatron 0700, 0843
 Alfide 0672
 Allorgan 0217
 Allstar 0037
 Ambassador 0177
 America Action 0180
 Amplivision 0217, 0370
 Ampro 0751
 Amstrad 0037, 0171, 0177, 1037
 Anam 0003, 0180, 0250, 0628, 0700
 Anam National 0055, 0250, 0650
 Andersson 1163
 Anex 0037
 Anhua 0051
 Anitech 0037, 0282
 Ansonic 0370, 0556
 AOC 0003, 0018, 0019, 0030, 0052, 0060, 0092, 0093, 0108, 0178, 0179, 0180, 0185, 0451, 0628, 1150
 Apex 0156, 0765
 Apex Digital 0748, 0765, 0767, 0879, 0890
 Arcam 0217
 Archer 0003

Ardem 0037, 0486, 0556, 0633, 0714
 Aristona 0037, 0556
 ART 1037
 Astra 0037
 Asuka 0217
 ATD 0698
 Atlantic 0001
 Audinac 0180
 Audiosonic 0037, 0217, 0370, 0486, 0714
 Audioton 0217, 0486
 Audiovox 0003, 0092, 0180, 0451, 0623, 0802, 0875
 Autovox 0217
 Aventura 0171
 Awa 0037, 0108, 0157, 0217, 0512, 0606, 0698
 Axxon 0714
 Baile 0001, 0661
 Baird 0208, 0217
 Bang & Olufsen 0565
 Baosheng 0817
 Basic Line 0037, 0217, 0282, 0556, 1037, 1163
 Baur 0037, 0146, 0512
 Baysonic 0180
 Bazin 0217
 Beaumark 0178
 Beijing 0001, 0208, 0226, 0661, 0812, 0817
 Beko 0037, 0370, 0486, 0606, 0714, 1037
 Belcor 0019
 Bell & Howell 0016, 0154
 BenQ 1032, 1756
 Beon 0032, 0037
 Best 0370
 Bestar 0037, 0370
 Binatone 0217
 Black Diamond 0556, 0587, 1037
 Blaupunkt 0170, 0195
 Blue Sky 0037, 0282, 0556, 0606, 0714, 1037, 1254
 Blue Star 0282
 Boots 0217
 Boxlight 0893
 BPL 0037, 0208, 0282
 Bradford 0180
 Brandt 0335, 0560, 0625, 0714
 Brandt Electronique 0335
 Brinkmann 0037, 0486
 Britannia 0217
 Brockwood 0019

Broksonic 0003, 0180, 0236, 0463
 Bush 0037, 0208, 0217, 0282, 0486, 0556, 0661, 0698, 0714, 1037
 Caihong 0817
 Cailing 0748
 Candle 0030, 0046, 0056, 0186
 Carad 0037, 1037
 Carena 0037
 Carnivale 0030
 Carver 0054, 0170
 Cascade 0037
 Casio 0037
 Cathay 0037
 CCE 0037, 0217
 Celebrity 0000
 Celera 0765
 Celestial 0767
 Centrex 0698, 0780
 Centrum 1037
 Centurion 0037
 CGE 0370
 CGM 1037
 Changcheng 0001, 0051, 0661, 0817
 Changfei 0817
 Changfeng 0817
 Changhai 0817
 Changhong 0156, 0508, 0765, 0767, 0783, 0817, 1156
 Chengdu 0817
 Ching Tai 0003, 0092, 0179
 Chun Yun 0000, 0003, 0092, 0179, 0180, 0700, 0843, 1150
 Chung Hsin 0053, 0108, 0180, 1150
 Chunsun 0817
 Cinema 0672
 Cinal 0092, 0451
 Citizen 0030, 0039, 0046, 0056, 0060, 0092, 0186, 0280
 Clairtone 0185
 Clarion 0180
 Clarivox 0037
 Clatronic 0037, 0217, 0370, 0556, 0606, 0714
 Clayton 1037
 CMS Hightec 0217
 Commercial Solutions 0047, 1447
 Concerto 0056
 Condor 0037, 0282, 0370
 Conia 0754
 Conic 0032
 Conrac 0808

Conrowa.....	0145, 0156, 0698, 1156	Durabrand	0003, 0171, 0178, 0180, 0463, 1034, 1463	Fujitsu	0037, 0179, 0186, 0217, 0683, 0809, 0853, 1181
Contec.....	0037, 0157, 0180, 0185, 0698	Dwin	0093, 0720, 0774	Fujitsu General	0217, 0683
Cosmel	0037	Dynatron.....	0037	Funai.....	0171, 0179, 0180, 0556, 1271
Craig.....	0180	Ecco	0706	Furi.....	0145, 0817
Crosley	0054	ECE	0037	Future	0037
Crown	0037, 0039, 0053, 0180, 0208, 0370, 0486, 0606, 0672, 0714	Elbe	0217	Futurtech	0180
Crown Mustang.....	0672	Electroband	0000, 0185	Galaxi.....	0037
Curtis Mathes.....	1347, 1147, 0702, 0466, 0451, 0166, 0154, 0145, 0093, 0060, 0056, 0054, 0051, 0047, 0039, 0030, 0016	Electrograph.....	1755	Galaxis.....	0037, 0370
CXC.....	0180	Electrohome	0381	Ganxin	0817
D-Vision.....	0037, 0556	Elekta.....	0037, 0282	Gateway	1755, 1756
D.Boss.....	0037	Elektra	0017, 1661	GE.....	1454, 1447, 1347, 1147, 0625, 0560, 0451, 0335, 0282, 0180, 0178, 0135, 0093, 0092, 0055, 0051, 0047, 0030, 0027, 0021
Daewoo	1661, 1150, 0880, 0865, 0706, 0700, 0672, 0661, 0634, 0628, 0623, 0556, 0451, 0217, 0180, 0178, 0170, 0154, 0108, 0092, 0056, 0039, 0037, 0032, 0030, 0019, 0003	Elin.....	0037, 0548	GEC	0037, 0217
Dansai	0032, 0037, 0208	Emerson	0714, 0623, 0486, 0463, 0451, 0370, 0282, 0280, 0236, 0185, 0180, 0179, 0178, 0177, 0171, 0154, 0039, 0038, 0037, 0019	General.....	0186
Dantax.....	0606, 0714	Emperor.....	0282	Genesis.....	0037
Datsura.....	0208	Envision.....	0030, 0813	Gericom.....	0808, 0865
Daytek	0037, 0706	Epson	0833, 0840, 1122, 1322	Giant.....	0217
Daytron.....	0019	Erres	0037	Gibraltar.....	0017, 0019, 0030
Dayu	0661	ESA.....	0171, 0812	Gintai	1150
De Graaf.....	0208, 0548	ESC	0037, 0217	Go Video.....	0886
DEC	0556, 0698	Ether	0003, 0030	GoldStar	0001, 0019, 0030, 0032, 0037, 0039, 0056, 0154, 0178, 0217, 0556, 0606, 0714, 1150
Decca	0037, 0217	Etron	0001	Goodmans.....	0032, 0037, 0179, 0217, 0335, 0360, 0451, 0480, 0556, 0560, 0634, 0661, 0714, 0808, 1037, 1163
Deitron.....	0037	Eurofeel	0217	Gorenje.....	0037, 0370
Dell	1080, 1178, 1264, 1454	EuroLine	0556	Gradiente.....	0053, 0056, 0170
Denon.....	0145, 0511	Euroman	0037, 0217	Graetz.....	0037, 0714
Denstar.....	0628	Europa	0037	Granada.....	0037, 0108, 0146, 0208, 0217, 0226, 0548, 0560
Denver.....	0037, 0587, 0606, 1189	Europhon.....	0217	Grandin.....	0037, 0282, 0714, 1037
Desmet.....	0037	Evolution.....	1756	Grundig.....	0037, 0195, 0370, 0443, 0556, 0587, 0672, 0683, 0706
Diamant.....	0037	Exquisit.....	0037	Grunpy.....	0179, 0180
Diamond.....	0037, 0672, 0698, 0706	Fagor	0037	H&B	0808
Dick Smith Electronics	0698	Feilu.....	0817	Haaz	0706
Digatron.....	0037	Feiyue.....	0817	Haier	0037, 0508, 0587, 0698, 0768, 1034
Digital Life	0780, 0872	Ferguson	0037, 0053, 0335, 0443, 0548, 0560, 0625	Haiyan.....	0817
Digitor.....	0037, 0698	Fidelity	0037, 0171, 0512	Halifax.....	0217
Digix	0880	Filsai	0217	Hallmark	0178
DiK.....	0037	Finlandia	0208, 0548	Hammerstein	0060
Dixi	0037	Finlux.....	0037, 0179, 0217, 0480, 0556, 0606, 0629, 0631, 0714, 0808	Hampton.....	0217
DL.....	0037, 0780, 0872	Firstar	0236	Hankook	0019, 0030, 0056, 0178, 0180, 0628
Domeos.....	0037, 1037	Firstline.....	0037, 0208, 0217, 0556, 0587, 0714, 0808, 1037	Hanseatic.....	0037, 0195, 0217, 0282, 0556, 0634, 0661, 0714, 0808
Dream Vision	1704	Fisher.....	0047, 0154, 0157, 0159, 0208, 0217, 0370	Hantarex	0037, 0865
DSE	0698	Flint.....	0037	Hantor.....	0037
Dual	0037, 0217	Formenti	0037		
Dual Tec.....	0217	Fortress	0093		
Dumont	0017, 0019	Fraba	0037, 0370		
		Friac.....	0037, 0370		
		Frontech	0217		

Harley Davidson.....	0179	Interbuy	0037, 0512	Kongque.....	0817
Harman/Kardon.....	0054	Interfunk	0037, 0512	Konka	0037, 0282, 0587, 0628, 0632, 0638, 0703, 0707, 0714, 0754, 0817
Harsper.....	0865	Internal	0037	Korpel	0037
Harvard.....	0180	Intervision	0037, 0217, 0282, 0370, 0486	KTV.....	0030, 0039, 0180, 0185, 0217, 0280
Harwood.....	0032, 0037	IR.....	0032, 0037, 0093, 0108, 0146, 0157, 0195, 0217, 0226, 0370, 0512, 0556	Kunlun	0051, 0208, 0226, 0661, 0817
Havermy.....	0093	IRT.....	0451, 0628, 0698, 1661	Kyoshu.....	0032
HCM.....	0037, 0217, 0282, 0606	Isukai	0037, 0282	Kyoto	0032, 0217
Helios	0865	ITC.....	0217	L&S Electronic.....	0714, 0808
Hello Kitty.....	0451	ITT	0179, 0208, 0480, 0548	LaSAT	0486
Hema.....	0217	ITT Nokia	0179, 0208, 0480, 0548, 0606	Lecson.....	0037
Hher.....	0714	ITV	0037	Lemair.....	0032
Himitsu	0180, 0628	Janeil	0046	Lenco.....	0037, 1037
Hinari	0037, 0179	JBL	0054	Levis Austria.....	0037
Hisawa.....	0282, 0714	JCB.....	0000	Leyco.....	0037
Hisense	0037, 0145, 0156, 0208, 0508, 0512, 0556, 0706, 0748, 0780, 1156	Jean.....	0003, 0051, 0092, 0156, 0179, 0236	LG.....	1265, 1178, 0856, 0714, 0700, 0698, 0644, 0606, 0556, 0442, 0178, 0108, 0060, 0056, 0039, 0038, 0037, 0032, 0030, 0019, 0003, 0001
Hitachi	0217, 0381, 0480, 0481, 0508, 0512, 0548, 0578, 0629, 0634, 0719, 1037, 1045, 1145, 1150, 1156, 1225, 1245, 1256, 0016, 0019, 0027, 0030, 0032, 0037, 0038, 0039, 0056, 0092, 0108, 0145, 0151, 0156, 0157, 0165, 0178, 0179, 0186	Jensen.....	0698, 0706, 0761, 0815, 0817	Liesenk & Tter.....	0037
Hitachi Fujian.....	0037, 0108, 0145, 0150	Jiahua.....	0051	Liesenkotter.....	0037
Home Electronics.....	0606	Jinfeng.....	0051, 0208, 0226, 0817	Lifotec.....	0037, 0714, 1037
Hongmei.....	0093, 0817	Jinque.....	0817	Lihua.....	0817
Hongyan.....	0817	Jinxing	0037, 0054, 0145, 0156, 0556, 0698, 0817	Lloyd's	0001
Hornlyphon	0037	JMB	0443, 0556, 0634	Lloytron.....	0032
Hoshai	0282	JNL.....	0698	Loewe	0037, 0136, 0512, 0633, 0790
Hua Tun	1150	Jubilee	0556	Logik.....	0001, 0016, 0060, 0698, 0706, 0880
Huafa.....	0145	Juhua.....	0817	Longjiang.....	0817
Huanghe.....	0817	JVC.....	0053, 0093, 0463, 0508, 0606, 0653, 0683, 0731, 1172, 1253	Luma.....	1037
Huangshan	0817	Kaige	0817	Lumatron	0217
Huanyu.....	0817	Kaisui.....	0037, 0217, 0282	Lux May.....	0037, 0556
Huari.....	0145	Kambrook.....	0217, 0556	Luxman.....	0056
Hugoson.....	0890	Kangli	0001, 0661, 0817	Luxor	0179, 0208, 0217, 0480, 0548, 0631, 1037, 1163
Huodateji.....	0051	Karcher.....	0037, 0282, 0606, 0714	LXI	0047, 0054, 0154, 0156, 0178
Hyper.....	0217	Kathrein.....	0556	M & S.....	0054
Hypson	0037, 0282, 0714, 1037	Kaypani	0052	M Electronic.....	0037, 0217, 0480
Hyundai	0037, 0698, 0706, 0849, 0865	KEC	0180	Madison.....	0037
Iberia	0037	Kendo	0037, 0512	Magnavox.....	0020, 0024, 0030, 0037, 0054, 0096, 0179, 0186, 0187, 0386, 0706, 0780, 0802, 1198, 1254, 1454
ICE.....	0217, 0556	Kennex	1037	Magnum	0037, 0606, 0714
Imperial.....	0037, 0370	Kenwood	0019, 0030	Majestic	0016
Imperial Crown	0001, 0661	KIC.....	0217	Manesth.....	0037, 0217
Indiana.....	0037	Kiota	0001	Manhattan	0037, 1037
Infinity.....	0054	Kioto	0054, 0556, 0706	Marantz.....	0030, 0037, 0054, 0556, 0704, 0854, 0855, 1154, 1454
Ingelen.....	0714	Kiton	0037	Mark	0037, 0217, 0486, 0714
Inno Hit.....	0037, 0217, 0282	KLH	0765, 0767	Masuda.....	0037, 0217
Innova.....	0037	KLL	0037		
Innowert	0865	Kloss.....	0024, 0046		
Inteq.....	0017	Kneissel.....	0037, 0556		
		Kolin	0053, 0108, 0150, 0180, 1150		

Materin	0208	Nansheng	0817	Palsonic.....	0001, 0037, 0217, 0698
Matsui.....	0037, 0177, 0195, 0208, 0217, 0335, 0443, 0556, 0629, 0714, 1037	NAT	0226	Panama	0037, 0217
Matsushita.....	0051, 0250, 0650	National	0051, 0055, 0208, 0226, 0508	Panashiba.....	0001
Matsuyama.....	0587	NEC	1704, 1182, 1150, 0882, 0817, 0704, 0661, 0603, 0508, 0497, 0381, 0217, 0186, 0178, 0170, 0165, 0156, 0154, 0056, 0053, 0051, 0046, 0030, 0019	Panasonic.....	1650, 1410, 1177, 1175, 1168, 0853, 0650, 0548, 0508, 0250, 0226, 0208, 0108, 0055, 0054, 0051, 0037
Maxent	1755	Neckermann	0037, 0370, 0512, 0556	Panavision	0037
Mediator	0037	NEI.....	0037	Panda	0051, 0208, 0226, 0508, 0698, 0706, 0780, 0817
Medion	0037, 0512, 0556, 0698, 0714, 0808, 0880, 1037, 1248	Neovia	0865	Pathe Cinema.....	0370
Megapower	0700	Nesco	0179	Penney.....	0003, 0018, 0019, 0021, 0027, 0030, 0032, 0039, 0047, 0051, 0056, 0060, 0135, 0156, 0178, 1347
Megatron.....	0003, 0145, 0178	Netsat.....	0037	Perdio	0037, 0282
MEI.....	0185, 1037	NetTV.....	1755	Phase.....	0032
Meile.....	0817	Network.....	0032	Philco.....	1661, 0774, 0628, 0463, 0451, 0370, 0186, 0180, 0178, 0145, 0096, 0092, 0056, 0054, 0037, 0032, 0030, 0020, 0019
Melectronic.....	0037, 0195, 0217, 0480, 0512, 0634, 0661, 0714	Neufunk.....	0037, 0556, 0714	Philex	0548
Memorex	0016, 0056, 0060, 0150, 0154, 0178, 0179, 0250, 0463, 1037	New Tech.....	0217	Philips	1756, 1454, 1154, 0774, 0690, 0556, 0512, 0187, 0186, 0178, 0108, 0092, 0080, 0056, 0054, 0051, 0037, 0032, 0030, 0027, 0024, 0020, 0019, 0017, 0000
Mercury	0001, 0060, 0556, 0706	Newave.....	0092, 0093, 0178, 1150	Phoenix.....	0037, 0486
Mermaid	0037	Nikkai.....	0032, 0037, 0217	Phonola	0037, 0080
Metronic	0625	Nikko	0030, 0092, 0178	Pilot	0019, 0030, 0037, 0039, 0706
Metz	0037, 0388, 0447, 0587, 0746	Noblex	0154, 0180	Pioneer	0037, 0038, 0166, 0170, 0486, 0512, 0679, 0760, 0866, 1260
MGA	0019, 0030, 0037, 0150, 0178	Nokia	0179, 0208, 0480, 0548, 0606, 0631	Pionier	0486
Micromaxx.....	0037, 0808, 1037	Norcent.....	0748, 0824	Playsonic	0037, 0217, 0714
Microstar	0808	Nordic.....	0217	Polaroid	0765, 0865, 1276
MicroTEK.....	0706	Nordmende	0037, 0195, 0335, 0560, 0714	Polytron	0282
Midland	0017, 0032, 0039, 0047, 0051, 0135	Normerel.....	0037	Portland.....	0019, 0039, 0092
Minato	0037	Noshi	0018	Powerpoint	0037
Minerva.....	0108	Novak	0037	Premier	0037
Minutz.....	0021	Novatronic	0037	Prima	0761, 0783, 0815, 0817
Mitsubishi.....	1250, 1182, 1171, 1150, 1037, 0868, 0836, 0817, 0556, 0512, 0381, 0250, 0236, 0208, 0180, 0179, 0178, 0154, 0150, 0108, 0093, 0056, 0037, 0030, 0019	NTC	0092	Princess.....	0698
Mivar	0217, 0370, 0609	Nu-Tec.....	0037, 0698, 0706	Princeton	0700, 0717
Monivision	0700, 0843	Oceanic	0208, 0548	Prinston	1037
Morgan's	0037	Okano.....	0037, 0370	Prism	0051
Motorola.....	0055, 0093	Omni.....	0698, 0706, 0780, 0872	Profex	0370
MTC.....	0019, 0030, 0056, 0060, 0185, 0370, 0512	Onimax	0714	Profitronic.....	0037
MTEC	0032	Onking	0280	Proline.....	0037, 0556, 0625, 0634
MTLogic	0714	Onwa	0180, 0602	Proscan	0047, 1347, 1447
Mudan	0051, 0208, 0226, 0817	Optimus.....	0154, 0166, 0250, 0650	Prosonic	0037, 0217, 0451, 0714
Multitec	0037, 0486, 1037	Optoma	0887	Protech	0037, 0180, 0217, 0486, 1037
Multitech	0037, 0180, 0217, 0486, 0556	Optonica.....	0093, 0165	Proton.....	0001, 0003, 0030, 0039, 0052, 0056, 0178, 0466, 0644
Murphy.....	0039	Orion.....	0037, 0177, 0179, 0236, 0443, 0463, 0556, 0606, 0714, 0880, 1463	ProVision	0037, 0556, 0714
Musikland.....	0037	Online.....	0037	Pulsar.....	0017, 0019
Myryad	0556	Ormond	1037		
NAD.....	0156, 0178, 0866	Osaki	0032, 0037, 0217, 0556		
Naiko	0037, 0606	Osume.....	0032, 0037, 0157		
		Otto Versand	0037, 0093, 0217, 0226, 0512, 0556		
		Pacific.....	0037, 0556, 0714, 1037		
		Palladium.....	0037, 0370, 0714		

Pye	0037, 0556	Samsux	0039	Simpson	0186, 0187
Qingdao.....	0051, 0208, 0226, 0817	Sandra.....	0217	Singer	0335, 0548, 0698, 0706, 1537
Qualcraft.....	0039	Sansei.....	0451	Sinotec	0706
Quasar.....	0051, 0055, 0165, 0250, 0650, 0865	Sansui.....	0037, 0463, 0587, 0602, 0698, 0706, 0714, 1537	Sinudyne.....	0177
Quelle	0037, 0512, 1037	Sanyo	1154, 1150, 1142, 0893, 0799, 0798, 0556, 0508, 0486, 0381, 0370, 0280, 0217, 0208, 0180, 0159, 0157, 0156, 0154, 0146, 0145, 0108, 0088	SKY.....	0037, 0282
Questa.....	0032	Sanyuan	0093, 0817	Skygiant.....	0180
R-Line.....	0037	SBR	0037, 0556	Skyworth	0037, 0698, 0748, 0817
Radiola	0037, 0217, 0556	Schaub Lorenz	0037, 0486, 0548, 0606, 0714	Sliding.....	0865
Radiomarelli	0037	Schneider	0037, 0217, 0556, 0714, 1037	SLX.....	0512
RadioShack.....	0019, 0030, 0032, 0037, 0039, 0047, 0056, 0154, 0165, 0178, 0180	Scimitsu.....	0019	Soemtron.....	0865
Radiotone.....	0037, 1037	Scotch	0178	Solavox.....	0032, 0037, 0548
Rank Arena.....	0157, 0602	Scott.....	0019, 0178, 0179, 0180, 0236	Sole	0813
RCA	1547, 1454, 1447, 1347, 1247, 1147, 1047, 0679, 0625, 0618, 0560, 0178, 0135, 0093, 0092, 0090, 0060, 0051, 0047, 0038, 0030, 0019, 0018, 0000	Sears	0047, 0054, 0056, 0146, 0154, 0156, 0159, 0171, 0178, 0179	Soniko	0037
Realistic.....	0019, 0030, 0032, 0039, 0056, 0154, 0165, 0178, 0180	Seaway.....	0556, 0634	Sonitron	0208, 0217, 0370
Recor.....	0037	Seelver.....	1037	Sonoko	0037, 0282
Rediffusion	0548	SEG	0037, 0217, 0634, 1037, 1163	Sonolor	0208, 0282, 0548
Reflex	0037, 1037	SEI.....	0177	Sontec	0037, 0370
Relisys.....	0865	Sei-Sinudyne.....	0037	Sony	1651, 1505, 1300, 1167, 1100, 1010, 0834, 0650, 0250, 0170, 0157, 0156, 0150, 0145, 0111, 0093, 0080, 0053, 0037, 0000
Reoc.....	0714	Semivox.....	0180	Soundesign	0178, 0179, 0180, 0186
Revox	0037	Semp.....	0156, 1356	Soundwave.....	0032, 0037
RFT	0037, 0370	Serino	0093	Sowa.....	0051, 0060, 0092, 0156, 0178, 0226, 1150
Rhapsody.....	0185	Shancho	0817	Spectricon	0003
Ricoh	0037	Shanghai	0208, 0226, 0817	Squareview.....	0171
Rinex	0698	Shaofeng.....	0145, 0817	Ssangyong.....	0032
Roadstar.....	0037, 0282, 0714, 1037, 1189	Sharp.....	1193, 1165, 0851, 0818, 0787, 0720, 0689, 0688, 0650, 0491, 0386, 0165, 0157, 0093, 0053, 0039, 0032, 0030	SSS.....	0019, 0180
Rowa	0037, 0217, 0556, 0587, 0698, 0748, 0817	Shen Ying.....	0003, 0092, 0179	Stag	0032
Royal Lux	0335	Shencai.....	0145	Standard.....	0037, 0217, 1037
Runco.....	0017, 0030, 0497, 0603	Sheng Chia.....	0093, 0179, 0236, 1150	Starlite	0037, 0180
Ruyi	0817	Shenyang	0817	Stenway.....	0282
Saba	0250, 0335, 0548, 0560, 0625, 0714	Shintoshi.....	0037	Strato.....	0037
Sagem	0830	Shivaki.....	0037, 0178, 0443, 0451	Studio Experience	0843
Saige	0817	Shogun.....	0019	Sunic Line.....	0037
Saisho	0177, 0217, 0556	Shorai	0179	Sunkai.....	0037
Saivod	0037, 1037	Show	0706	Sunstar	0037
Salora	0208, 0480, 0548, 0606, 0631	Siemens.....	0032, 0037, 0146, 0157, 0195	Sunwood	0037
Salsa.....	0335	Siesta.....	0370	Superscan	0864
Sampo.....	0030, 0032, 0039, 0052, 0092, 0093, 0154, 0171, 0178, 0650, 0700, 1755	Signature	0016	Supersonic	0037, 0208, 0698, 1189
Samsung	1150, 1060, 0817, 0814, 0812, 0774, 0766, 0718, 0702, 0682, 0644, 0618, 0587, 0556, 0370, 0226, 0019, 0030, 0032, 0037, 0039, 0056, 0060, 0090, 0092, 0093, 0154, 0156, 0178, 0179, 0195, 0208, 0217	Silva.....	0037	SuperTech	0037
		Silva Schneider.....	0037	Supra.....	0039, 0056, 0178
		Silver.....	0037, 0179	Supre-Macy.....	0046
		SilverCrest.....	1037	Supreme	0000
				Susumu	0335
				SVA.....	0587, 0698, 0748, 0768, 0865, 0870, 0871, 0872
				Sylvania	0020, 0030, 0054, 0096, 0171, 0381
				Symphonic	0171, 0180

Synco	0000, 0060, 0092, 0093, 0178, 0451	Texet	0217	Videotechnic.....	0217
Sysline.....	0037	ThemeScene	0887	Vidikron.....	0054
T+A.....	0447	Thompson	0625	Vidtech.....	0019, 0178
Tacico	0092, 0178, 0179, 1150	Thomson	0037, 0335, 0560, 0625, 1447	Viewsonic	0857, 0864, 0885, 1755
Tai Yi.....	1150	Thorn	0037, 0335, 0512	Viking.....	0046
Taishan	0817	Tiane.....	0093, 0817	VInc.....	1756
Tandy.....	0039, 0093, 0217	TMK.....	0056, 0177, 0178	Vision	0032, 0037, 0217
Targa.....	0702	TML	1756	Vistar.....	0548
Tashiko	0032, 0092, 0146, 0217, 0650, 1150	TNCi	0017	Vizio	0864, 0885, 1756
Tatung.....	0003, 0037, 0051, 0054, 0055, 0060, 0154, 0156, 0217, 0556, 0629, 1150, 1156, 1254, 1756	Tobo.....	0748	Voxson.....	0178
TCL.....	0698, 0706, 1537	Tokai	0037, 1037	Waltham.....	0037, 0217, 0443, 1037
TCM.....	0714, 0808	Tokaido.....	1037	Wards	1347, 1156, 1147, 0866, 0187, 0186, 0180, 0179, 0178, 0166, 0165, 0156, 0154, 0135, 0111, 0096, 0000, 0016, 0017, 0018, 0019, 0020, 0021, 0024, 0027, 0030, 0047, 0051, 0054, 0055, 0056, 0060, 0080
Teac	0037, 0170, 0171, 0178, 0217, 0282, 0512, 0556, 0698, 0706, 0714, 1037, 1755	Tomashi	0282	Warumaia.....	0661
Tec.....	0037, 0217	Tongtel.....	0587, 0780	Watson	0037, 1037
Tech Line	0037	Tophouse.....	0180	Waycon.....	0156
Technics	0051, 0250, 0556, 0650	Toshiba	1704, 1656, 1508, 1356, 1265, 1256, 1169, 1156, 1150, 0845, 0832, 0718, 0714, 0650, 0644, 0618, 0556, 0508, 0381, 0217, 0195, 0156, 0154, 0145, 0093, 0060	Wega.....	0037
TechniSat.....	0037, 0556	Tosonic	0185	Wegavox.....	0037
Technisson	0714	Totevision	0039	Welltech.....	0714
Technol Ace.....	0179	Towada	0217	Weltblick.....	0217
Technosonic	0556	Toyoda.....	0037	Westinghouse.....	0003, 0451, 0889, 0890
Techview.....	0847	Trakton.....	0217	Weston.....	0037
Techwood.....	0003, 0051, 0056, 1163	Trans Continens	0037, 0217, 1037	Wharfedale	0037, 0556, 0706
Tecnimagen	0556	Transonic.....	0037, 0512, 0587, 0698, 0780	White Westinghouse.....	0037, 0186, 0463, 0623
Teco.....	0051, 0092, 0093, 0178, 0280, 0653	Triad.....	0037, 0556	Windsor	1037
Tedalex	0037, 0208, 0217, 0556, 0606, 0706, 1537	Trical	0157	Windstar	0282
Tek.....	0706	Triumph.....	0177, 0556	Windy Sam	0556
Teknika	0016, 0019, 0039, 0054, 0056, 0060, 0092, 0150, 0179, 0180, 0186	Tsoschi	0282	Wintel.....	0714
Telecor.....	0037	Tuntex.....	0030, 0092	World-of-Vision.....	0880, 0890
Telefunken	0037, 0056, 0335, 0486, 0560, 0587, 0625, 0698, 0702, 0706, 0714	TVS.....	0463	Xenius.....	0634, 0661
Telefusion	0037	TVTEXT 95.....	0556	Xiahua.....	0698, 0817
Telegazi	0037, 0556	Uher.....	0037, 0480, 0486	Xihu.....	0817
Telesonic	0037	Ultravox	0037	XLogic.....	0698
Telestar.....	0037, 0556	Unic Line	0037	XMS.....	0698
Teletech	0037, 1037	United	0037, 0606, 0714, 1037	Xrypton	0037
Teleton.....	0186, 0217	Universal.....	0027, 0037	Yamaha.....	0019, 0030, 0650, 0769, 0833, 0839
Teleview.....	0037	Universum	0032, 0037, 0146, 0157, 0170, 0177, 0217, 0370, 0480, 0512, 0556, 0618, 0631, 1037	Yamishi	0217, 0282
Tempest.....	0037, 0556	Univox	0037	Yapshe.....	0250
Tennessee	0037	V2max	0865	Yokan.....	0037
Tensai	0037, 0217, 0556, 1037	V7 Videoseven.....	1755	Yoko.....	0037, 0217
Tera.....	0030, 0092, 0466	V7Videoseven.....	0880	Yoshita.....	0706
Tesla	0037	Vector Research	0030	Youlanasi	0817
Tevion	0556, 0714, 0767, 1037, 1248	Vestel.....	0037, 0217, 0556, 1037, 1163	Zenith.....	0016, 0017, 0092, 0178, 0463, 1145
		Victor	0053, 0250, 0650, 0653	Zenor	0208
		Videocon	0508	Zonda	0003, 0698

CBL

Cable box

ABC.....	0001, 0003, 0007, 0008, 0011, 0013, 0014, 0017, 0237
ADB.....	1063, 1230, 1269
Aichi Denshi.....	1512
Alcatel.....	0896
Allegro.....	0153, 0315
Americast.....	0899
Amstrad.....	1222
Antronix.....	0022, 0207
Archer.....	0022, 0153, 0207, 0797
Auna.....	1230, 1269
Austar.....	0012, 0276
Belcor.....	0056
Bell & Howell.....	0014
Bell South.....	0899
Birmingham Cable Communications.....	0276
British Telecom.....	0003
Cable & Wireless.....	1068
Cable Star.....	0056
Cabletenna.....	0022
Cableview.....	0022
Century.....	0153
Citizen.....	0153, 0315
Clearmaster.....	0883
ClearMax.....	0883
Colour Voice.....	0025, 0031
Comcast.....	1376
Comtronics.....	0040
Contec.....	0019
Coolmax.....	0883
Daeryung.....	0008, 0477, 0877, 1877
Digeo.....	1187
Digi.....	0637
Director.....	0476
Dumont.....	0637
DX Antenna.....	1500
Eastern.....	0002
Emerson.....	0797
Everquest.....	0015, 0040
Focus.....	0400
Foxtel.....	1222
France Telecom.....	0817, 0896
Freebox.....	1482
Fujitsu.....	1497
Funai.....	0019

Galaxi.....	0008
Garrard.....	0153
GC Electronics.....	0056, 0207
GE.....	0237
Gehua.....	0476
Gemini.....	0015, 0797
General Instrument.....	0003, 0011, 0014, 0015, 0276, 0476, 0810
GMI.....	0015, 0797
Golden Channel.....	1063, 1110
GoldStar.....	0040, 0144
Goodmind.....	0797
Hamlin.....	0009, 0020, 0034, 0259, 0273
Hitachi.....	0011, 0014
Hytex.....	0007
i3 Micro.....	1602
Jasco.....	0015, 0153, 0315
Jebsee.....	0400
Jerrold.....	0003, 0011, 0012, 0014, 0015, 0276, 0476, 0810
KNC.....	0008
Leon.....	0015
LG.....	0040, 0144
Linsay.....	0440
Macab.....	0817
Madritel.....	1230
Magnavox.....	0014, 0027
Maspro.....	1510
Memorex.....	0000
MNET.....	0019
Motorola.....	0014, 0276, 0476, 0810, 1106, 1187, 1254, 1376, 1483
Movie Time.....	0063, 0156
Mr Zap.....	1112
Mr. Zap.....	1112
MS.....	0015
Multichoice.....	0019
Multitech.....	0883
MultiVision.....	0012
Myrio.....	1602
NEC.....	1496
Nokia.....	1569
Noos.....	0817, 1624
Novaplex.....	0618
NSC.....	0063, 0156
NTL.....	0003, 1060, 1068
Oak.....	0007, 0019
Ono.....	1068
Optimus.....	0021
Optus.....	0276, 1060

Pace.....	0008, 0237, 1060, 1068, 1577, 1877
Panasonic.....	0000, 0008, 0021, 0040, 0107, 0375, 1488
Panther.....	0637
Paragon.....	0000
Philips.....	0013, 0025, 0027, 0031, 0153, 0317, 0817, 1305
Pioneer.....	0144, 0533, 0877, 1021, 1500, 1877
Popular Mechanics.....	0400
Pulsar.....	0000
PVP Stereo Visual Matrix.....	0003
Quasar.....	0000
Quiero.....	0817
RadioShack.....	0015, 0315, 0797, 0883
RCA.....	0021, 1256
Realistic.....	0207
Recoton.....	0400
Regal.....	0020, 0259, 0273, 0279
Regency.....	0002
Rembrandt.....	0011
Runco.....	0000
Sagem.....	0817, 1089, 1112
Salora.....	0000
Samsung.....	0000, 0040, 0144, 1060, 1666
Satbox.....	0375
Scientific Atlanta.....	0008, 0017, 0237, 0477, 0877, 1510, 1877
Seam.....	0510
Sejin.....	1602
Signal.....	0015, 0040
Signature.....	0011
SL Marx.....	0040
Sony.....	1006, 1460
Sprucer.....	0021
Starcom.....	0003, 0014, 0015
Stargate.....	0015, 0040, 0797
Starquest.....	0015
STS.....	0156
Suena Madritel.....	1230
Sumitomo.....	1500
Supercable.....	0276
Supermax.....	0883
Sylvania.....	0001
Tadiran.....	0040
Tandy.....	0258
Televue.....	0040
Telewest.....	1068
Texscan.....	0001
TFC.....	0310

Thomson	1110, 1256
Time Warner	1877
Timeless	0040
Tocom.....	0012, 0013
Torx.....	0003
Toshiba.....	0000, 1509
Trans PX	0153, 0276, 0315
TransACT.....	1106
Tri-Vision.....	1257
Tristar.....	0883
TS.....	0003
Tusa.....	0015
TV86.....	0063
Unika.....	0022, 0153, 0207
United Artists.....	0007
United Cable	0003
Universal	0022, 0056, 0153, 0191, 0207
US Electronics.....	0276
V2.....	0883
Viewmaster.....	0883
Viewstar.....	0027, 0063, 0258
Vision.....	0883
Vortex View.....	0883
Zenith	0000, 0008, 0525, 0899
Zentek	0400

SAT

Satellite receiver

@sat.....	1300
@Sky	1334
ABsat.....	0713
ADB.....	1259, 1367, 1473, 1491
Aiwa.....	1514
Akai	0200
Alba	0713
Allsat.....	0200, 1017, 1043
Alltech	0713
Allvision	1232, 1334, 1412
AlphaStar.....	0772
Amino	1615
Amitronica	0713
Amstrad.....	0713, 0795, 0847, 1175
Anglo	0713
Ankaro.....	0713, 1279
AntSat	1017
Arcon.....	1043, 1075, 1279
Arcus	1143

Arnion.....	1300
Asat	0200
ASCI	1334
ASLF.....	0713
AssCom.....	0853
Aston	1129, 1261
Astra	0713
Astro.....	0133, 0173, 0658, 1099, 1100
Atsat	1300
AtSky	1334
Audioline.....	1429
Austar	1259
Axis.....	1111
Bentley Walker	1017
Black Diamond.....	1284
Blaupunkt	0173
Blue Sky	0713
Boca.....	0713, 1232, 1366
Brainwave.....	1294
British Sky	0847, 1175, 1847 Broadcasting
Broco.....	0713
BskyB	0847, 1175
Bubu Sat	0713
Bush	1284, 1471
Canal Digital	0853
Canal Satellite	0853, 1339, 1853
Canal+	0853
CanalSatellite	0853, 1339
Centrex.....	1457
Century.....	0856
Chaparral.....	0216
Chess	0713, 1334
CityCom	0299, 1075, 1176, 1232
CNS.....	1367
Comag.....	1169, 1232, 1366, 1412
Coship	1457
Crossdigital	1109
Cyfra+.....	1076
Cyrus.....	0200
D-box	0723, 0873
Daewoo	0713, 1111, 1296
Deltasat	1075
Dgtec.....	1242
Digatron.....	1294
Digena	1100
Digenius.....	0299, 1161
Digipro.....	1105
Digiturk.....	1076

DirecTV.....	1856, 1749, 1640, 1639, 1609, 1444, 1443, 1442, 1414, 1392, 1377, 1142, 1109, 1108, 1076, 0819, 0749, 0724, 0639, 0566, 0392, 0247, 0099
Dish Network	System 0775, 1005, 1170, 1505, 1775
Dishpro	0775, 1005, 1505, 1775
Distratel	1283
Distrisat	0200
DMT	1075
DNT	0200
Dream Multimedia	1237, 1437, 1637
DX Antenna.....	1530
Echostar	0167, 0280, 0610, 0713, 0775, 0853, 1005, 1169, 1170, 1200, 1323, 1409, 1467, 1477, 1505, 1775
Einhell	0713
Elap.....	0713, 1129
Elsat.....	0713
Elta.....	0200
eMTech.....	1214
Engel.....	0713, 1017
EuroLine	1251
Europhon	0299
Eurosky.....	0299
Eutelsat.....	0713
Expressvu.....	0775, 1775
Fenner	0713
Ferguson.....	1291
Flair Mate.....	0713
Fortec Star.....	1017, 1293, 1550
Foxtel.....	1176, 1356
Freecom	0173
FTEmaximal	0713, 1449, 1556
Fuba	0173, 0299, 1161, 1214
Fugionkyo.....	1105
Galaxis.....	0853, 1111, 1557
Garnet.....	1075
GbSAT	1214
GE.....	0392, 0566
Gecco.....	1273, 1412
General Instrument.....	0869
GF.....	1043
GF Star	1043
Globo.....	1251
GOD Digital.....	0200
GOI	0775, 1775
Goldbox.....	0853
Golden Interstar.....	1283
Goldvision.....	1017
Goodmans.....	1246, 1284

Gradiente.....	0099, 0856	M vision.....	1557	Pace.....	0200, 0241, 0329, 0795, 0847, 0853, 1175, 1323, 1356, 1423, 1623
Grundig.....	0173, 0750, 0847, 0853, 1150, 1291, 1330, 1335	Magnavox.....	0722, 0724	Packard Bell.....	1111
Hanseatic.....	1099, 1100	Manata.....	0713	Palcom.....	0299, 1161
Hauppauge.....	1294	Manhattan.....	1017	Panarex.....	1159
HB.....	1214	Marantz.....	0200	Panasonic.....	0247, 0701, 0847, 1104, 1304, 1320, 1404, 1508, 1526
HDT.....	1159	Maspro.....	0173, 0713, 0750, 1520, 1530	Panda.....	0173
Hirschmann.....	0173, 0299, 1111	Mastec.....	1334	Pansat.....	1159, 1551
Hisense.....	1535	Matsui.....	0173, 1284	Paysat.....	0724
Hitachi.....	0819, 1250, 1284, 1518, 1523, 1525	Maximum.....	1075, 1334	Philips.....	1749, 1442, 1142, 1118, 1114, 1076, 0856, 0853, 0819, 0750, 0749, 0724, 0722, 0200, 0173, 0133, 0099
Homecast.....	1214	Mediacom.....	1206	Phoenix.....	1273
HTS.....	0775, 1775	MediaSat.....	0853	Phonotrend.....	1017, 1200
Hughes.....	0749, 0819, 1442, 1749	Medion.....	0299, 0713, 1043, 1075, 1161, 1232, 1334, 1412	Pilotime.....	1339
Hughes Network Systems.....	0749, 1142, 1442, 1443, 1444, 1749	Medison.....	0713	Pino.....	1334
Humax.....	1176, 1427, 1568, 1648, 1670, 1675	Mega.....	0200	Pioneer.....	0329, 0352, 0853, 1308, 1442
Huth.....	1017, 1075	Memorex.....	0724	Preisner.....	1366
Hyundai.....	1075, 1159	Metronic.....	0713, 1279, 1283, 1334	Premiere.....	0723, 0873, 1429
iCan.....	1367	Metz.....	0173	Prima.....	0795
ID Digital.....	1176	Micro.....	0713, 1294	Primacom.....	1111
ILLUSION sat.....	1557	Micro electronic.....	0713	Prod.....	0639, 0723, 0873
iLo.....	1535	Micromaxx.....	0299	Proscan.....	0392, 0566
Imperial.....	1429	Microstar.....	1075	Protek.....	1567
Innova.....	0099	Microtec.....	0713	Proton.....	1535
Interstar.....	1017, 1105, 1214	Mitsubishi.....	0749, 0819	QNS.....	1367, 1404
IR.....	0173, 0282	Morgan's.....	0200, 0713, 1232	Quelle.....	0299
Jaeger.....	1334	Motorola.....	0856, 0869	Radiola.....	0200
Jerrold.....	0869	Myryad.....	0200	RadioShack.....	0869
JVC.....	0775, 1170, 1507, 1531, 1532, 1775	Mysat.....	0713	RCA.....	0143, 0392, 0566, 0855, 1291, 1392
K-SAT.....	0713	NEC.....	1270, 1519	Realistic.....	0052
Kamm.....	0713	NEOTION.....	1334	Rebox.....	1214
Kaon.....	1300	Netgem.....	1322	Regal.....	1251
KaTelco.....	1111	Netsat.....	0099	RFT.....	0200
Kathrein.....	0173, 0200, 0249, 0658, 0713, 1057, 1221, 1416, 1561, 1567	Neuhaus.....	0713	Roadstar.....	0713, 0853
Kenwood.....	0853	Neuling.....	1232	Rover.....	0713
Koscom.....	1043, 1334, 1409	Neusat.....	0713, 1279, 1334, 1409	S-ZWO.....	1207
Kreiling.....	0249, 0658	Neveling.....	1161	SAB.....	1251
Kreismeyer.....	0173	Next Level.....	0869	Sagem.....	0820, 1114, 1253, 1307, 1690
L&S Electronic.....	1043, 1334	NextWave.....	1017, 1143, 1551	Samsung.....	0853, 1017, 1108, 1109, 1206, 1243, 1244, 1276, 1293, 1343, 1377, 1442, 1458, 1570, 1609
Labgear.....	1296	Nikko.....	0200, 0713	Sanyo.....	1219
LaSAT.....	0173, 0299	Nokia.....	0723, 0751, 0853, 0873, 1023, 1223, 1311, 1312, 1723	Sat Control.....	1300
Lenco.....	0713	Nordmende.....	1611	Sat Cruiser.....	1143
Lenoxx.....	1611	OctalTV.....	1294, 1505	Sat Team.....	0713
LG.....	1075, 1226, 1414	Opentel.....	1232, 1412	Satec.....	0713
Lifesat.....	0299, 0713, 1043	Optex.....	1043, 1283		
Lodos.....	1284	Optus.....	1143		
Logix.....	1017, 1075	Orbis.....	1334		
Lorenzen.....	0299, 1161, 1294	Orbitech.....	1099, 1100		

Satelco 1232
 Satplus 1100
 Schaub Lorenz 1214
 Schneider 1206, 1251
 Schwaiger 1075, 1111, 1334, 1457
 SCS 0299
 Sedea Electronique 1105, 1206, 1283
 SEG 1075, 1251
 Serino 0610
 Servi Sat 0713
 ServiSat 1251
 Sharp 1489, 1517
 Siemens 0173, 1657
 Silva 0299
 Skantin 0713
 SKR 0713
 SKT 1449
 SKY 0099, 0847, 0856, 1175, 1847, 1848, 1856
 SKY Italia 1847, 1848
 Sky XL 1251, 1412
 Sky+ 1175
 Skymaster 0713, 1075, 1200, 1409, 1611
 Skymax 0200
 Skyplus 1232, 1334, 1409, 1412
 SkySat 0713
 Skyvision 1334
 SL 0299, 1294
 SM Electronic 0713, 1200, 1409
 Smart 0299, 0713, 1232, 1273
 Sony 0282, 0639, 0847, 0853, 1524, 1558, 1639, 1640
 Star Choice 0869
 Starlite 0200
 Stream 1847, 1848
 Strong 0853, 1105, 1159, 1258, 1300, 1409, 1430
 Sunny 1300
 Sunsat 0713
 Supermax 1143, 1283
 TCL 1143
 Teac 1251, 1322
 TechniSat 0200, 1099, 1100, 1195, 1322
 Technomate 1283
 Technosat 1143, 1206
 Technotrend 1429
 Techsan 1017
 Techwood 1284
 tekComm 1017

Teleciel 1043
 Teleka 0750
 Telestar 1099, 1100, 1251, 1334
 Telesystem 1251
 Teledes 1214, 1300
 Tempo 1143
 Tevion 0713, 1334, 1409
 Thomson 0392, 0713, 0820, 0847, 0853, 1046, 1175, 1291, 1498, 1900
 Tivo 1142, 1442, 1443, 1444
 Tokai 0200
 Tonna 0713
 Topfield 1206, 1207, 1545
 Toshiba 0749, 0790, 0819, 1285, 1446, 1501, 1516, 1530, 1749
 TPS 0820, 1253, 1307
 Triax 0200, 0713, 0853, 1099, 1251, 1291, 1296
 Trio 1075
 TT-micro 1429
 Turnsat 0713
 Twinner 0713
 UltimateTV 1392, 1640
 Uniden 0052, 0722, 0724, 1521
 Unimax 1457
 Unisat 0200
 United 1251
 Universum 0173, 0299, 1099, 1251
 US Digital 1535
 USDTV 1535
 Van Hunen 1161
 Variosat 0173
 Ventana 0200
 Vestel 1251
 Visionic 1105, 1206, 1279, 1283
 Visiosat 0713, 1129, 1457
 Voom 0869
 Wintel 0299, 1161
 Wisi 0173, 0299
 Wisplus 1258
 Worldsat 1251, 1323
 XMS 1075
 Xsat 0713, 0847, 1214, 1323
 Xtreme 1300
 Zehnder 1075, 1232, 1251, 1334, 1412, 1413
 Zenith 0856, 1856

DVD

DVD

3D Lab 0539
 A-Trend 0714
 Acoustic Solutions 0713, 0730, 1242
 Adcom 1094
 Advent 1016
 AEG 0770, 0788, 0790
 AFK 1051
 Afrey 0698
 Aim 0699, 0778, 0818, 0833, 1165
 Airis 1005, 1224
 Aiwa 0533, 0641, 1633
 Akai 0690, 0705, 0766, 0770, 0779, 0788, 0790, 0884, 0898, 0899, 1089, 1115
 AKI 1005
 Akira 0699
 Akura 0898, 1051, 1367
 Alba 0539, 0672, 0695, 0699, 0713, 0717, 0730, 0783, 1051
 Albatros 1001
 Alco 0790
 Allegro 0869
 Altacom 1224
 Amitech 0770, 0784, 0850
 Amphion 0872, 1176
 Media Works
 Amstrad 0713
 AMW 0872, 1176
 Ansonic 0831
 Apex 0672, 1061
 Apex Digital 0672, 0717, 0755, 0794, 0796, 0797, 0830, 1004, 1020, 1056, 1061, 1100
 Arianet 0770, 0818
 Asono 1224
 Aspire Digital 1168, 1407
 Atacom 1224
 ATD 0718
 Audiologic 0736
 Audiosonic 0690, 1265
 Audiovox 0717, 0790, 1041, 1071, 1072, 1121, 1122
 Auvio 0843
 Awa 0730, 0872
 Axion 0730, 1071, 1072
 B & K 0655, 0662
 Basic Line 0713
 Baze 0898, 1165

DEVICE CODES

BBK.....	1224	CyberHome.....	0714, 0816, 0874, 1023, 1024, 1117, 1129	Elta.....	0672, 0690, 0770, 0788, 0850, 1051, 1115
Bel Canto Design.....	1571	Cydectin.....	1074	Eltax.....	0766
Bellagio.....	1004	Cytron.....	0651	Emerson.....	0591, 0675, 0705, 0816, 0821, 1268
Black Diamond.....	0698, 0713, 0766, 0833, 0884	D-Vision.....	1115	Encore.....	0698
Blaupunkt.....	0717	Daenyx.....	0872	Enterprise.....	0591
Blue Parade.....	0571	Daewoo.....	0705, 0714, 0770, 0784, 0832, 0833, 0869, 0870, 0872, 1169, 1172, 1234, 1242	Enzer.....	0665, 0766, 0770, 0784
Blue Sky.....	0651, 0672, 0695, 0713, 0769, 0778, 0804, 0843	Daewoo.....	0872	EuroLine.....	0788, 1115
Boghe.....	1004	Daewoo.....	0872	Fenner.....	0651, 0769
Boman.....	0783	International		Ferguson.....	0651
Brainwave.....	0770, 1115	Dalton.....	1036	Finlux.....	0591, 0672, 0676, 0741, 0770, 0783, 1165
Brandt.....	0503, 0551, 0651	Dansai.....	0770, 0783, 1115	Fintec.....	0784, 1169
Broksonic.....	0695, 0868	Dantax.....	0539, 0713, 0790, 1089, 1358	Firstline.....	0651, 0713, 0799, 0843, 0869
Bush.....	1695, 1165, 1128, 1051, 1021, 0884, 0879, 0833, 0831, 0778, 0758, 0730, 0717, 0713, 0699, 0695, 0690, 0676, 0672, 0516	Daytek.....	0872, 1005	Fisher.....	0670
C-Tech.....	0798	Dayton.....	0872	Funai.....	0675, 0695, 1268, 1334
California.....	0490	DCE.....	0831	Gateway.....	1073, 1077, 1158
Audio Labs		DEC.....	0778, 0818	GE.....	0522, 0717, 0815
Cambridge Audio.....	1109	Decca.....	0770, 1115	General Electric.....	0717
Cambridge.....	0690	Denon.....	0490, 0634, 1282, 1634	Global Solutions.....	0768
Soundworks		Denver.....	0699, 0778, 0788, 0818, 0898, 1107, 1165, 1353, 1359	Go Video.....	0715, 0741, 0744, 0783, 0833, 0869, 1044, 1075, 1099, 1144, 1158, 1304, 1483, 1730
Cat.....	0699, 1087	Desav.....	0770	Go Vision.....	1071, 1072
CAVS.....	1057	Desay.....	0800, 0843, 1407	GoldStar.....	0591, 0741
CCE.....	0730	Diamond.....	0651, 0768, 0790	Goodmans.....	0651, 0690, 0713, 0730, 0783, 0790, 0833, 0879, 1004, 1730
Celestial.....	1020	Dick Smith.....	0833, 1483, 1730	GPX.....	0699, 0769
Centrex.....	0672, 1004	Digihome.....	0713	Gradiente.....	0490, 0651
Centrum.....	0713, 0779, 1005	digiRED.....	0717	Graetz.....	0665
CGV.....	1115	Digitor.....	0651, 0690, 1005	Gran Prix.....	0831, 0898
Changhong.....	0627, 1061	Digitrex.....	0672, 1056, 1100	Grandin.....	0672, 0713, 1233
Cinea.....	0831	DIGIXmedia.....	0826	Greenhill.....	0717
Cinego.....	1399	DiK.....	0831	Grundig.....	0539, 0551, 0651, 0670, 0695, 0705, 0713, 0775, 0790, 1004, 1036, 1128, 1695, 1730
Cineral.....	0730	Dinamic.....	0788	Grunkel.....	0770
Cinetec.....	0713	Disney.....	0675, 1270	GVG.....	1169
cineULTRA.....	0699	DiViDo.....	0705	H & B.....	0818, 0841, 0850, 1233
CineVision.....	0833, 0869, 0876, 1483	DK Digital.....	0831	H&B.....	0713, 0818, 0841, 0850, 1233
Citizen.....	1277	DMTech.....	0783, 1271	Haier.....	0843
Classic.....	0730, 1385, 1730	Dragon.....	0831	Hanseatic.....	0741, 0783
Clatronic.....	0672, 0788, 0818, 1165	DSE.....	0833, 1483, 1730	Harman/Kardon.....	0582, 0702
Clayton.....	0713	DTS.....	0799	HCM.....	0788
Coby.....	0730, 0770, 0778, 0852, 1086, 1107, 1115, 1165, 1177, 1351	Dual.....	0651, 0665, 0713, 0730, 0779, 0783, 0790, 0831, 1068, 1085	HDT.....	0705
Codex.....	1233	Durabrand.....	0713, 0831, 1003, 1127	Hen.....	0713
Compacts.....	0826, 1265	DVD2000.....	0521	Hher.....	0651, 0713, 0826, 0831, 1224
Conia.....	0516, 0672, 0798, 0852, 1004	DVX.....	0768	HiMAX.....	0843
Continental Edison.....	0768, 0831	ECC.....	0730	Hisense.....	0718
Craig.....	0831	Electrohome.....	0770, 0784		
Crown.....	0690, 0769, 0770, 1115	Elfunk.....	0850		
Curtis Mathes.....	1087	Elin.....	0770		
Cybercom.....	0831	Ellion.....	0850		

Hitachi.....	0573, 0664, 0695, 0713, 1247, 1664	Limit.....	0768	Mustek.....	0730, 1730
Hiteker.....	0672, 0872	LiteOn.....	1058, 1158, 1416, 1440	Mx Onda.....	0651
Home Electronics.....	0730	Loewe.....	0511, 0539, 0741, 0885	Myryad.....	0894
Home Tech.....	1107, 1224	Logix.....	0705, 0783	NAD.....	0591, 0692, 0741
Hoyo.....	0665	Luker.....	1367	Naiko.....	0770, 1004, 1367
Humax.....	0646	Lumatron.....	0705, 0741, 0833, 1115	Nakamichi.....	1222
Hyundai.....	0766, 0768, 0783, 0850	Lunatron.....	0741	Narita.....	1115
iLo.....	1348	Luxman.....	0573	NEC.....	0591, 0692, 0785, 0869, 1404
Ingelen.....	0788	Luxor.....	0713, 1004, 1695, 1730	Neovia.....	1271
Initial.....	0717, 0839	Magnasonic.....	0651, 0769	Nesa.....	0717
Integra.....	0571, 0627, 1634	Magnavox.....	0503, 0539, 0646, 0675, 0713, 0818, 0821	Neufunk.....	0665
IRT.....	0783	Magnex.....	1165	Nevir.....	0770, 0831
ISP.....	0695	Malata.....	0782, 1159	NextBase.....	0826
Jaton.....	0665, 1078	Manhattan.....	0705, 0713	NexxTech.....	1402
JBL.....	0702	Marantz.....	0539	Nintaus.....	1051
JDV.....	1367	Mark.....	0713	Norcent.....	0872, 1003, 1107, 1265
Jeken.....	0699	Marquant.....	0770	Nordmende.....	0831
Jensen.....	1016	Matsui.....	0651, 0672, 0695, 0713, 0884, 1004, 1695, 1730	Noriko.....	0752
Jindian.....	0799	Maxdorf.....	0788	Nowa.....	0843
JMB.....	0695	Maxim.....	0713, 0872	Nu-Tec.....	0516
JNC.....	0672	MBO.....	0690, 0730, 1730	Okano.....	0752
JSI.....	1423	McIntosh.....	1273, 1533	Olidata.....	0672
JVC.....	0503, 0539, 0558, 0623, 0867, 1164, 1241, 1275	MDS.....	0778	Omni.....	0690, 0698, 0778, 0833
jWin.....	1049, 1051	Mecotek.....	0770	Onix.....	0672, 0852
Karcher.....	0783	Medion.....	0630, 0651, 0758, 0770, 0783, 0820, 0831, 0879	Onkyo.....	0503, 0627, 0792, 1417, 1418, 1612
Kawasaki.....	0790	MEI.....	0790	Oopla.....	1158
Kendo.....	0699, 0713, 0831	Memorex.....	0690, 0695, 0831, 1270	Oppo.....	1224
Kennex.....	0713, 0770, 0898	Metronic.....	0690	Optim.....	0843
Kenwood.....	0490, 0534, 0682, 0737	Metz.....	0525, 0571, 0713	Optimus.....	0525
Kiirro.....	0770	Microboss.....	0718	OptoMedia Electronics.....	0896
King DHome.....	0799	Micromaxx.....	1695	Orava.....	0818
Kingavon.....	0818	Micromedia.....	0503, 0539	Orion.....	0695, 1128, 1695
Kiss.....	0665, 0841	Micromega.....	0539	Oritron.....	0651
KLH.....	0717, 0790, 1020, 1149, 1261	Microsoft.....	0522	Ormond.....	0713
KLH Digital.....	0717	Microstar.....	0831	Otic.....	0826
Koda.....	0818	Minato.....	0752	P&B.....	0770, 0818
Konka.....	0711, 0719, 0720, 0721	Minax.....	0713	Pacific.....	0695, 0713, 0768, 0790, 0804, 0831
Koss.....	0651, 0896, 1423	Minerva.....	0705	Packard Bell.....	0770
Landel.....	0826	Minoka.....	0770	Palladium.....	0695, 0779
Lasonic.....	0798, 1173	Minowa.....	1165	Palsonic.....	0672, 0852
Lawson.....	0768	Mintek.....	0717, 0839	Panasonic.....	0490, 0503, 0632, 0703, 1010, 1011, 1282, 1362, 1462, 1490, 1762
Lecson.....	1533	Mirror.....	0752, 0879	Panda.....	0717
Lenco.....	0651, 0699, 0713, 0770, 0778, 0818, 1165	Mitsubishi.....	0521, 0713, 1403, 1521	Paramount Pictures.....	0779
Lenoxx.....	0690, 1127	Mizuda.....	0770, 0818	peeKTon.....	1224
Lexia.....	0699, 0768	Momitsu.....	1082	Philco.....	0690, 0788, 0790
LG.....	0591, 0741, 0790, 0801, 0869	Monyka.....	0665	Philips.....	0503, 0539, 0646, 0675, 0854, 0885, 1158, 1260, 1267, 1354, 1818
Lifetec.....	0651, 0831	MPX.....	0843		
		MTLogic.....	1265		

Phonotrend.....	0672, 0699, 0818, 1165	Sansui.....	0695, 0768, 0784, 1695	Star Cluster.....	0768
PianoDisc	1024	Sanyo	0670, 0695, 0873	Starlogic	1005
Pioneer	0490, 0525, 0571, 0631, 0632, 1571, 1816	Scan	0705, 0850	Starmedia	0818, 1005, 1224
Plu2	0850	ScanMagic	0730	Strong.....	0713
Pointer.....	0784	ScanSonic	1695	Sungale.....	1074
Polaroid	1020, 1061, 1086, 1200	Schaub Lorenz	0770, 0788, 1115	Sunkai.....	0770, 0850
Polk Audio.....	0539	Schneider	0539, 0651, 0705, 0713, 0779, 0783, 0788, 0790, 0804, 0831	Sunstech	0831
Portland.....	0770	Schwaiger.....	0752	Sunwood	0788, 0898
Powerpoint	0872	Scientific Labs.....	0768, 0798	Superscan	0821
Powtek	0852	Scott.....	0651, 0672, 0718, 0797, 1005, 1036	Supervision.....	0768
Prima	0766, 1016	Seeltech	1224	SVA.....	0672, 0717, 0860, 1105
Prima Electronic	0766	SEG	0665, 0713, 0768, 0798, 0872, 0884	Sylvania	0630, 0675, 0821, 1268
Princeton.....	0674	Semp.....	0503	Symphonic	0675, 1268
Prinz	0831	Sensory Science	1158	Synn	0768
Prism	0705	Shanghai	0672	TAG McLaren.....	0894
Proceed.....	0672	Sharp.....	0630, 0675, 0713, 0752, 1256	Tandberg.....	0713
Proline	0651, 0672, 0833, 1004	Sharper Image.....	1112, 1117	Tatung.....	0770
Proscan	0522	Sherwood	0633, 0717, 0741, 0770, 1043, 1077	Teac	0516, 0571, 0692, 0695, 0717, 0741, 0758, 0768, 0790, 0809, 0833, 1021, 1051, 1483
Proson.....	0713	Shinco	0717	Tec.....	0898
Prosonic	0752	Shinsonic.....	0533, 0839	Technics.....	0490, 0703
ProVision	0699, 0778	Sigma Designs	0674	Technika	0768, 0770, 0831, 1115, 1165
Qwestar	0651	Sigmatek	1005	Technisson.....	1115
Radionette.....	0741, 0869	Siltex.....	1224	Technosonic	0730, 1051, 1115
Raite.....	0665	Silva.....	0788, 0831, 0898	Techwood	0692, 0713
RCA.....	0522, 0571, 0717, 0769, 0790, 0822, 1022, 1132, 1193	Silva Schneider.....	0831, 0898	Tedexlex	0690, 0768, 1004
REALmagic.....	0674	Simaudio	0885	Telefunken	0758, 0770, 0788, 0790, 0833
REC.....	0490, 0766	Singer	0690, 0768	Teletech	0713, 0768
Recco	0698	Skantic	0539, 0713, 1003	Telra	0676
Red Star	0770, 0788, 0898, 1003	Skymaster	0730, 0768	Tensai	0651, 0690, 0770
Redstar.....	0898	Skysonic.....	0766	Terapin.....	1031
Reoc.....	0752, 0768	Skyworth	0766, 0898	Tevion	0651, 0768, 0798, 0833, 0898, 1036, 1382
Resonance	0651	Slim Art.....	0784	Theta Digital	0571
Revoy	0699, 0841	Slim Devices.....	0533	Thomson.....	0522, 0551
Rio.....	0869	SM Electronic	0690, 0730, 0768	Tivo.....	1816
RJTech	1360	Smart.....	0705, 0713, 0718	Tokai	0665, 0698, 0784, 0788, 0790, 0898
Roadstar.....	0690, 0699, 0713, 0730, 0818, 0833, 0879, 0898, 1051, 1339	Sonai	0755	Tokaido	0698
Ronin.....	0872	Sonashi.....	0831	Toshiba	0503, 0695, 1045, 1154
Rotel.....	0558, 0623, 1178	Sonic Blue	0783, 0869, 1099	TRANS-continent.....	0799, 0826, 0831, 0843, 0872
Rowa.....	0516, 0717, 0823, 0872, 1004	Sony	0533, 0573, 0772, 0864, 1017, 1033, 1069, 1070, 1133, 1389, 1431, 1533, 1633	Transonic	0672, 0730, 1165
Saba.....	0551, 0651, 0769	Soundmaster.....	0768	Tredex.....	0799, 0800, 0803, 0804, 0843
Sabaki	0798	Soundmax	0768	Trio.....	0770, 0784
Saivod	0831, 1367	Soundwave.....	0783	TSM	1224
Sakyno	0768	Sova	1122	TYT	0705
Salora	0741	Spectra.....	0872	Umax	0690
Sampo.....	0698, 0752	Standard.....	0651, 0768, 0788, 0831	United	0672, 0695, 0768, 0788, 0826, 0852, 1115, 1165
Samsung	0490, 0573, 0744, 0820, 0899, 1044, 1075, 1118				

Universal Multimedia..... 0768
 Universum 0591, 0713, 0741, 0779, 0869
 Urban Concepts..... 0503
 US Logic..... 0839
 V 1064
 Venturer 0790
 Vestel..... 0713
 Vieta 0705
 Viewmaster..... 1224
 VInc 1064, 1226
 Vizio..... 1064, 1226
 Vocopro..... 1027
 Voxson..... 0690, 0730, 0831
 Walkvision 0717
 Welkin..... 0831
 Wellington..... 0713
 Wesder 0699
 Wharfedale 0698, 0752, 0768, 0790
 Wilson..... 0831
 Windsor 0713
 Windy Sam 0573
 WIZE..... 1115
 Woxtor..... 1005, 1224
 Xbox..... 0522
 Xenius..... 0651, 0790
 XLogic 0768, 0798
 XMS..... 0770, 0788
 Xoro..... 1173
 Xwave..... 1001
 Yakumo 1004, 1056
 Yamada 0872, 1004, 1056, 1158
 Yamaha 0490, 0539, 0545, 0646, 0817, 1282
 Yamakawa..... 0665, 0872
 Yukai..... 0730, 1730
 Zenith 0503, 0591, 0741, 0869
 Zeus 0784
 Zoece 1265

Aiwa..... 1468, 1336, 1284, 0742, 0687, 0680, 0479, 0468, 0352, 0348, 0315, 0307, 0209, 0124, 0037, 0032, 0000
 Akai..... 0020, 0037, 0041, 0061, 0081, 0106, 0175, 0240, 0315, 0348, 0352, 0642
 Akashi..... 0072
 Akiba 0072
 Akura 0072, 0271
 Alba 0000, 0020, 0072, 0081, 0209, 0278, 0315, 0348, 0352
 Alienware..... 1972
 Allstar 0081
 Ambassador 0020
 America Action 0278
 American High..... 0035
 Amoisonic..... 0479
 Amstrad..... 0000, 0072, 0278
 Anam 0037, 0162, 0226, 0240, 0278, 0480, 0579, 1037
 Anam National..... 0162, 0226, 1162, 1562
 Anitech 0072
 Ansonic..... 0000
 Apelsound 0209
 Aristona 0081
 ASA 0037, 0081
 Asha 0240
 Asuka..... 0037, 0038
 Audiosonic..... 0072, 0278
 Audioton 0020
 Audiovox 0037, 0278, 0781
 AVP..... 0352
 Awa..... 0037, 0043, 0278, 0642, 0687
 Baird 0000, 0041, 0104, 0106
 Basic Line..... 0020, 0046, 0072, 0104, 0278
 Beaumark..... 0240
 Beko 0104
 Bell & Howell 0104
 Bestar 0278
 Black Diamond..... 0081, 0642
 Black Panther 0278
 Blaupunkt 0034, 0081, 0162, 0226
 Blue Sky 0037, 0072, 0209, 0278, 0348, 0352, 0480, 0642
 Bondstec 0020, 0072
 Brandt..... 0041, 0320
 Brandt Electronic..... 0041
 Brinkmann 0209, 0348
 Broksonic 0002, 0121, 0184, 0209, 0348, 0352, 0479, 1479

Bush 0000, 0072, 0081, 0209, 0278, 0315, 0348, 0352, 0642, 0742
 Calix..... 0037
 Canon 0035
 Capehart..... 0020
 Carena 0209
 Carrefour 0045
 Carver 0081
 Casio 0000
 Cathay 0278
 Catron..... 0020
 CCE 0072, 0278
 CGE 0000
 Changhong..... 0048, 0081
 Cimline..... 0072
 Ceneral 0278
 Citizen..... 0037, 0278, 1278
 Clatronic 0000, 0020, 0072
 Colt 0072
 Combitech..... 0352
 Condor..... 0020, 0278
 Craig 0037, 0047, 0072, 0240, 0271
 Crown 0020, 0037, 0072, 0271, 0278, 0480
 Curtis Mathes 0035, 0041, 0060, 0162, 0760, 1035
 Cybernex 0240
 CyberPower..... 1972
 Cyrus 0081
 Daewoo 0020, 0045, 0046, 0104, 0209, 0278, 0352, 0561, 0637, 0642, 0844, 0877, 1278
 Dansai..... 0072, 0278
 Dantax 0352
 Daytron 0020, 0278
 De Graaf 0042, 0046, 0048, 0081, 0104
 Decca 0000, 0008, 0067, 0081, 0209, 0348, 0352
 Deitron 0278
 Dell..... 1972
 Denko 0072
 Denon 0042
 Diamant 0037
 Diamond 0209, 0348
 Dick Smith Electronics 0579, 0642
 Digitor 0579, 0642
 DirecTV 0739
 Domland 0209
 DSE..... 0579, 0642

VCR

VCR

ABS 1972
 Accent 0072
 Admiral 0048, 0209, 0479
 Adventura..... 0000
 Adyson 0072
 Aiko 0278
 Aim 0020, 0209, 0278, 0642



DEVICE CODES

Dual	0000, 0041, 0081, 0278, 0348	Goodmans.....	0000, 0020, 0037, 0062, 0072, 0081, 0209, 0278, 0343, 0348, 0352, 0637, 0642	IR	0020, 0041, 0042, 0045, 0047, 0072, 0081, 0104, 0106, 0208, 0209, 0226, 0240, 0343, 0348
Dumont	0000, 0081, 0104, 0105	GPX	0037	Irradio	0072, 0081
Durabrand	0038, 0039	Gradiente.....	0000, 0008	ITT.....	0041, 0046, 0104, 0106, 0240
Dynatech.....	0000	Graetz.....	0041, 0104, 0106, 0240	ITT Nokia	0552
Elbe	0038, 0278	Granada.....	0000, 0037, 0042, 0046, 0048, 0081, 0104, 0226, 0240	ITV	0020, 0037, 0278
Elcotech	0072	Grandin.....	0000, 0037, 0072, 0209, 0278, 0742, 0844	ITV Videomaster	0020
Electrohome.....	0037, 0043	Gronic.....	0104	JBL	0278
Electroponic	0037	Grundig.....	0034, 0072, 0081, 0226, 0320, 0347, 0348, 0352, 0742	Jensen	0041
Elin.....	0240	Haaz	0348	JMB	0209, 0348, 0352, 0742
Elsay.....	0072	Hanimex	0352	Joyce.....	0000
Elta	0072, 0278	Hanseatic	0037, 0038, 0081, 0209	JVC.....	0008, 0041, 0045, 0067, 0081, 1008, 1162, 1279, 1329
Emerex	0032	Hantor.....	0020	Kaisui.....	0072
Emerson.....	1593, 1479, 1278, 0637, 0593, 0561, 0479, 0348, 0343, 0278, 0240, 0209, 0208, 0184, 0121, 0072, 0061, 0045, 0043, 0037, 0035, 0002, 0000	Haojie	0240	Kambrook.....	0037
ESC	0020, 0240, 0278	Harley Davidson	0000	Karcher	0081, 0278
Europhon.....	0020	Harman/Kardon.....	0038, 0081	KEC	0037, 0278
Fenner	0020	Harwood.....	0072	Kendo	0072, 0106, 0209, 0278, 0315, 0348, 0642
Ferguson	0000, 0041, 0278, 0320	HCM	0072	Kenwood	0038, 0041, 0067
Fidelity.....	0000, 0072, 0240, 0278, 0352, 0432	Headquarter	0046	KIC.....	0000
Finlandia.....	0000, 0037, 0042, 0043, 0046, 0048, 0081, 0104, 0106, 0226	Hewlett Packard.....	1972	Kimari	0047
Finlux.....	0000, 0042, 0081, 0104, 0105, 0315	Hher.....	0278, 0642	Kioto	0348
Firstline.....	0037, 0043, 0045, 0072, 0209, 0278, 0348, 0480	HI-Q.....	0047	KLH.....	0072
Fisher.....	0020, 0046, 0047, 0104	Hinari.....	0041, 0072, 0208, 0240, 0278, 0343, 0352	Kneissel	0037, 0209, 0278, 0348, 0352
Flint.....	0209, 0348	Hisawa.....	0352	Kodak	0035, 0037
Frontech.....	0020, 0072	Hischito	0045	Kolin.....	0041, 0043
Fuji.....	0033, 0035	Hitachi	0000, 0037, 0041, 0042, 0046, 0081, 0089, 0105, 0240, 0593, 1037, 1326	Kolster	0209
Fujitsu.....	0000, 0045	Hornlyphon.....	0081	Korpel	0072
Fujitsu General	0037	Howard Computers.....	1972	Kuba Electronic	0047
Funai.....	0000, 0593, 1333, 1593	HP.....	1972	Kyoto	0072
Galaxis	0278	Hughes Network.....	0042, 0739	Lenco.....	0278
Garrard	0000	Systems		Leyco.....	0072
Gateway	1972	Humax	0739	LG.....	0037, 0038, 0042, 0045, 0209, 0480, 1037, 1237, 2010
GE	0035, 0048, 0060, 0202, 0209, 0226, 0240, 0320, 0760, 0761, 0807, 1035, 1060	Hush	1972	Lifetec.....	0209, 0348
GEC.....	0081	Hypson	0000, 0037, 0072, 0209, 0278, 0480	Linksys.....	1972
General.....	0020, 0045	iBUYPOWER	1972	Lloyd's	0000, 0208
General Technic.....	0348	Imperial.....	0000	Loewe.....	0037, 0081, 0105, 0162, 1562
Genexxa	0104	Ingersoll.....	0209, 0240	Logik.....	0072, 0106, 0209, 0240
Gessen	0278	Inno Hit.....	0072, 0432	Luker.....	0579
Go Video	0240, 0432, 0526	inotech.....	0278	Lumatron	0593
GoldHand	0072	Interbuy	0072	Lux May.....	0072
GoldStar	0037, 0038, 0209, 0225, 0226, 0348, 0480, 1237	Interfunk	0081, 0104	Luxor	0043, 0046, 0047, 0048, 0062, 0104, 0106, 0315
		Internal	0278, 0637	LXI	0037
		International.....	0037, 0278, 0642	M Electronic.....	0000, 0038
		Intervision	0000, 0209, 0278	Magnasonic	0278, 0593, 1278

Magnavox.....	0000, 0035, 0039, 0081, 0149, 0563, 0593, 0642, 1781	Nikkai.....	0020, 0072, 0278	Pioneer	0042, 0067, 0081, 0162, 1337, 1562
Magnin	0240	Nikko	0037	Polk Audio	0081
Magnum	0642	Nikon	0034	Portland.....	0020, 0278, 0637
Manesth	0045, 0072, 0081, 0209	Niveus Media.....	1972	Prinz.....	0000
Marantz	0035, 0038, 0062, 0081, 0209, 1381	Noblex	0240	Profitronic	0081, 0240
Mark	0000, 0278	Nokia	0041, 0042, 0046, 0048, 0081, 0104, 0106, 0240, 0278, 0315, 0552	Proline.....	0000, 0278, 0320, 0642
Marta.....	0037	Nordmende	0041, 0067, 0320	Proscan	0060, 0202, 0760, 0761, 1060
Mastec	0642	Northgate	1972	Prosonic	0278
Master's.....	0278	Novatronic	0209	Protec	0072
Matsui.....	0208, 0209, 0240, 0278, 0348, 0352, 0687, 0742	Nu-Tec	0209	Protech	0081, 0278
Matsushita.....	0035, 0162, 0226, 1162	Oceanic	0000, 0041, 0046, 0048, 0081, 0104, 0106	ProVision	0278
Media Center PC.....	1972	Okano.....	0072, 0209, 0278, 0315, 0348	Pulsar.....	0039
Medion	0209, 0348, 0352, 0642	Olympus	0035, 0226	Pye.....	0000, 0081
MEI.....	0035	Onida.....	0162	Qisheng	0060
Melectronic.....	0000, 0037, 0038	Onimax	0642	Quarter	0046
Memorex	1262, 1237, 1162, 1048, 1037, 0579, 0479, 0348, 0307, 0240, 0209, 0162, 0104, 0048, 0047, 0046, 0039, 0037, 0035, 0000	Onkyo	0222	Quartz.....	0046
Memphis	0072	Optimus.....	0037, 0048, 0104, 0162, 0432, 0593, 1048, 1062, 1162, 1262	Quasar	0035, 0162, 0278, 1035, 1162
Mercury	0020	Optonica.....	0062	Quelle	0081
Metronic	0081	Orbit	0072	Radialva.....	0037, 0048
Metz	0037, 0081, 0162, 0226, 0347, 0836, 1162, 1562	Orion.....	0002, 0121, 0184, 0208, 0209, 0343, 0348, 0352, 0479, 0687, 0742, 1479	Radiola	0081
MGA	0043, 0061, 0240	Osaki	0000, 0037, 0072	Radionette	0037
MGN Technology.....	0240	Osume.....	0072	RadioShack	0000, 0037, 1037
Micormay	0348	Otake.....	0209	Radix	0037
Micromaxx.....	0209, 0348	Otto Versand	0081	Randex	0037
Microsoft	1972	Pace	0352	Rank	0041
Mind	1972	Pacific.....	0000, 0348, 0642, 0742	Rank Arena.....	0041
Minolta	0042, 0105	Packard Bell	1972	RCA	1060, 1035, 0880, 0807, 0761, 0760, 0432, 0320, 0240, 0226, 0202, 0149, 0106, 0105, 0060, 0048, 0042, 0035, 0000
Mitsubishi	0000, 0041, 0043, 0048, 0061, 0067, 0081, 0480, 0642, 0807, 1343	Palladium.....	0037, 0041, 0072, 0209, 0315, 0348	Realistic.....	0000, 0035, 0037, 0046, 0047, 0048, 0062, 0104
Motorola.....	0035, 0048	Palsonic.....	0000, 0037, 0072, 0642	Reoc	0348, 0877
MTC.....	0000, 0240	Panasonic.....	1807, 1662, 1562, 1393, 1317, 1308, 1292, 1262, 1244, 1162, 1062, 1035, 0836, 0616, 0614, 0226, 0225, 0162, 0035	Replay Networks	0614
Multitec	0037	Pathe Cinema.....	0043	ReplayTV	0614, 0616
Multitech	0000, 0020, 0072, 0278	Pathe Marconi	0041	Rex	0041
Murphy	0000	Penney	0035, 0037, 0038, 0042, 0240, 1035, 1237	RFT	0072
Myryad	0081	Pentax	0042, 0105	Ricavision	1972
NAD.....	0104	Perdio	0000, 0209	Ricoh	0034
Naiko	0642	Philco.....	0000, 0035, 0038, 0072, 0209, 0226, 0479, 0561	Roadstar	0037, 0072, 0081, 0240, 0278, 0742
National	0162, 0226, 0240	Philips.....	0000, 0035, 0062, 0081, 0226, 0563, 0593, 0616, 0618, 0739, 1081, 1181, 1340, 1381	Royal.....	0072
Nebula Electronics	0033	Phoenix	0278	Runco	0039
NEC.....	0008, 0035, 0037, 0038, 0041, 0048, 0067, 0104, 0209, 0278, 1287	Phonola	0081	Saba	0041, 0062, 0067, 0278, 0320
Neckermann.....	0081	Pilot	0037	Saisho.....	0208, 0209, 0348
Nesco	0072			Salora	0043, 0046, 0104, 0106
Neufunk.....	0209			Sampo	0037, 0048
Newave	0037			Samsung	0045, 0240, 0432, 0739, 0760, 1014
				Samurai	0020

DEVICE CODES

Sanky	0039, 0048	Stern.....	0278	Toshiba.....	1972, 1503, 1325, 1323, 1290, 1145, 1008, 0845, 0742, 0432, 0352, 0209, 0081, 0067, 0045, 0043, 0042, 0041, 0008
Sansui	0000, 0041, 0067, 0072, 0106, 0209, 0271, 0348, 0479, 1479	Strong.....	0271	Totevision.....	0037, 0240
Sanyo	0046, 0047, 0048, 0067, 0104, 0159, 0209, 0240, 0348, 1330, 1331	STS.....	0042	Touch.....	1972
Saville.....	0240, 0278, 0352	Sunkai.....	0209, 0278, 0348	Towada.....	0072
SBR.....	0081	Sunstar.....	0000	Tradex.....	0081
Schaub Lorenz.....	0000, 0041, 0104, 0106, 0315, 0348	Suntronic.....	0000	Trakton.....	0020
Schneider.....	0000, 0037, 0042, 0072, 0081, 0240, 0278, 0348, 0352, 0637, 0642	Sunwood.....	0072	Triad.....	0278
Scott.....	0043, 0045, 0121, 0184	Supra.....	0037, 0240, 0278, 0348	Triumph.....	0208
Sears.....	0000, 0035, 0037, 0042, 0046, 0047, 0104, 0105, 1237	Sylvania.....	0000, 0035, 0043, 0081, 0593, 1593, 1781	Uher.....	0240
Seaway.....	0278	Symphonic.....	0000, 0593, 1593	Ultravox.....	0278
SEG.....	0072, 0081, 0240, 0278, 0561, 0637, 0642	Systemax.....	1972	Unitech.....	0240
SEI.....	0081	T+A.....	0162	United.....	0348
Seleco.....	0020, 0037, 0041	Tagar Systems.....	1972	Universal.....	0209
Semp.....	0045	Taisho.....	0209	Universum.....	0000, 0037, 0081, 0104, 0106, 0209, 0240, 0315, 0348
Sentra.....	0020, 0072	Tandberg.....	0278	Vector.....	0045
Serie Dorada.....	0037	Tandy.....	0000, 0104	Vector Research.....	0038
Sharp.....	0037, 0048, 0062, 0209, 0807, 0848, 1048, 1285, 1400	Tashiko.....	0000, 0037, 0048, 0081, 0240	Victor.....	0008, 0041, 0067
Shinco.....	0000	Tatung.....	0000, 0008, 0041, 0043, 0045, 0048, 0067, 0081, 0209, 0348, 0352	Video Concepts.....	0045, 0061
Shintom.....	0072, 0104	Tchibo.....	0348	Video Pro.....	0020
Shivaki.....	0037	TCM.....	0348	Video Technic.....	0000
Shogun.....	0240	Teac.....	0000, 0037, 0041, 0072, 0278, 0307, 0526, 0593, 0637, 0642, 0781, 0844	Videomagic.....	0037
Siemens.....	0037, 0046, 0081, 0104, 0320, 0347	Tec.....	0020, 0072	VideoPro.....	0020
Siera.....	0081	Tech Line.....	0072	Videosonic.....	0240
Silva.....	0037	Technics.....	0035, 0081, 0162, 0226, 1162	Viewsonic.....	1972
Silver.....	0278	TechniSat.....	0209	Villain.....	0000
Singer.....	0045, 0072, 0271, 0348	Teco.....	0035, 0037, 0038, 0041, 0048	Voodoo.....	1972
Sinudyne.....	0081, 0209, 0352	Tedex.....	0037, 0209, 0348, 0642	Wards.....	0760, 0240, 0149, 0081, 0072, 0062, 0060, 0048, 0047, 0046, 0045, 0042, 0039, 0038, 0035, 0033, 0000
Smaragd.....	0348	Teknika.....	0000, 0035, 0037	Watson.....	0081, 0352, 0642
Solavox.....	0020	Teleavia.....	0041	Wharfedale.....	0593, 0642
Sonic Blue.....	0614, 0616	Telefunken.....	0041, 0067, 0209, 0240, 0278, 0320, 0642	White Westinghouse.....	0072, 0209, 0278, 0637
Soniko.....	0072	Telestar.....	0037	World.....	0348
Sonitron.....	0104	Teletech.....	0000, 0072, 0278	XR-1000.....	0000, 0035, 0072
Sonneclair.....	0072	Tempest.....	0020	Yamaha.....	0038, 0041
Sonolor.....	0046, 0062	Tenosal.....	0072	Yamishi.....	0072, 0278
Sontec.....	0037	Tensai.....	0000, 0072, 0278	Yokan.....	0072
Sonwa.....	0642	Tevion.....	0209, 0348, 0642	Yoko.....	0020, 0037, 0240
Sony.....	0000, 0032, 0033, 0034, 0035, 0106, 0636, 1032, 1232, 1295, 1296, 1297, 1447, 1972	Textet.....	0020, 0278	Yoshita.....	0072
Soundwave.....	0037, 0209, 0348	Thomas.....	0000	Zenith.....	0000, 0033, 0034, 0039, 0209, 0479, 0637, 1139, 1479
Ssangyong.....	0072	Thomson.....	0041, 0060, 0067, 0202, 0278, 0320, 0722	ZT Group.....	1972
Stack 9.....	1972	Thorn.....	0037, 0041, 0104	ZX.....	0209, 0348, 0352
Starlite.....	0037	Tivo.....	0618, 0636, 0722, 0739, 1337, 1503		
		TMK.....	0208, 0240		
		Tokai.....	0037, 0072		
		Topline.....	0348		

DVR

Digital Video Recorder (DVR)

ABS	1972
Alienware.....	1972
CyberPower	1972
Dell	1972
DirecTV.....	0739
Gateway	1972
Howard Computers.....	1972
HP	1972
Hughes Network Systems	0739
Humax.....	0739
Hush.....	1972
iBUYPOWER.....	1972
JVC.....	1279
LG.....	2010
Linksys	1972
Media Center PC.....	1972
Microsoft	1972
Mind	1972
Niveus Media	1972
Northgate	1972
Panasonic.....	0616, 1244, 1807
Philips.....	0618, 0739, 1340
RCA.....	0880
ReplayTV	0614, 0616
Sonic Blue.....	0614, 0616
Sony	0636, 1447, 1972
Stack 9	1972
Systemax	1972
Tagar Systems.....	1972
Thomson	0722
Tivo.....	0618, 0636, 0722, 0739
Toshiba.....	1008, 1972
Touch.....	1972
Viewsonic	1972
Voodoo	1972
ZT Group.....	1972

HDTV

HDTV Decoder

Accurian	1653
DirecTV.....	0392
Epson	1563, 1650
Hisense.....	1535
iLo.....	1535
LG.....	1414, 1415
Macro Image Technology	1383
Motorola	1363
MyHD	1383
Panasonic.....	1120
Pioneer	1010
Princeton.....	0113, 0295
Proton.....	1535
Samsung	1276, 1190, 1490
Sasem	1641
Sensory Science	1126
Sharp.....	1010
Sylvania.....	1563
Telemann	1604
Toshiba.....	1446
US Digital	1535
USDTV.....	1535
Zenith	1856
Viewsonic	1329
Vizio	1126

Combination

TV/VCR
TV/VCR combination

Aiwa.....	0000, 0468, 0479, 0680, 0687, 0742, 1336, 1468
America Action.....	0278
Audiovox.....	0278
Broksonic.....	0002, 0479, 1479
Citizen.....	1278
Colt.....	0072
Curtis Mathes.....	1035
Daewoo.....	0637, 0844, 1278
Dick Smith Electronics.....	0579
Digitor.....	0579
DSE.....	0579
Emerson.....	0002, 0479, 0593, 0637, 1278, 1479
Funai.....	0000, 1333
GE.....	0240, 0807, 1035, 1060
GoldStar.....	1237
Goodmans.....	0343, 0637
Harley Davidson.....	0000
Hitachi.....	0000, 1326
JVC.....	1329
LG.....	0480, 1037
Lloyd's.....	0000
Magnasonic.....	0593, 1278
Magnavox.....	0000, 0593, 1781
Magnin.....	0240
Memorex.....	0162, 1037, 1162, 1237, 1262
MGA.....	0240
Mitsubishi.....	0043, 0807
Nokia.....	0552
Optimus.....	0162, 0593, 1162, 1262
Orion.....	0002, 0479, 1479
Panasonic.....	0162, 1035, 1162, 1262, 1308, 1317, 1662
Penney.....	0240, 1035, 1237
Philco.....	0479
Quasar.....	0162, 1035, 1162
RadioShack.....	0000, 1037
RCA.....	0240, 0807, 1035, 1060
Reoc.....	0877
Samsung.....	0432, 1014
Sansui.....	0000, 0479, 1479
Sanyo.....	0240, 1330, 1331

Sears.....	0000, 1237
Sharp.....	0807
Sony.....	0000, 1232, 1295, 1296, 1297
Sylvaniav.....	1781
Symphonic.....	0000, 0593
Teac.....	0000, 0593, 0637, 0781
Thomas.....	0000
Toshiba.....	0845, 1145, 1323, 1325
White Westinghouse.....	0637
Zenith.....	0000, 0479, 0637, 1479

TV/DVD
TV/DVD combination

Advent.....	1016
Apex Digital.....	0830
Audiovox.....	1071, 1121, 1122
Axion.....	1071
Broksonic.....	0695
Bush.....	0516, 0676, 0713, 0879, 0884
Cinego.....	1399
Classic.....	1385
Daewoo.....	0870
Dantax.....	1358
Denver.....	1353, 1359
DMTech.....	1271
Emerson.....	1268
Go Vision.....	1071
Goodmans.....	0879
Grundig.....	0695
Hitachi.....	1247
Jensen.....	1016
KLH.....	1261
Konka.....	0719, 0720
Mirror.....	0879
Neovia.....	1271
Panasonic.....	1490
Philips.....	0854, 1260
Prima.....	1016
RCA.....	1022, 1193
Roadstar.....	1339
Saivod.....	1367
Samsung.....	0899
Sansui.....	0695
Sova.....	1122
Sylvania.....	0675, 1268
Teac.....	0758, 1021

Toshiba..... 0695

TV/VCR/DVD
TV/VCR/DVD combination

Aikai.....	0899
Broksonic.....	0868
Emerson.....	0821
Funai.....	1334
Magnavox.....	0821
Orion.....	1128
Panasonic.....	1362, 1462
RCA.....	1132
Sharp.....	0630, 0807
Superscan.....	0821
Sylvania.....	0821
Toshiba.....	1045

VCR/DVD
VCR/DVD combination

Allegro.....	0869
Apex Digital.....	1061
Broksonic.....	0695
CineVision.....	0833, 0869, 1483
Daewoo.....	0833, 0869
Dick Smith Electronics.....	0833, 1483
DSE.....	0833, 1483
Emerson.....	0675, 1593
Funai.....	0675, 1593
Go Video.....	0715, 0741, 0744, 0833, 0869, 1044, 1075, 1483
GoldStar.....	0741
Hitachi.....	0664, 0000
JVC.....	0867, 1164, 1241
LG.....	0741, 0869
Lunatron.....	0741
Memorex.....	0695
Orion.....	1695
Panasonic.....	0490, 1762, 1562
Philips.....	0675, 1267, 0593
Polaroid.....	1061
RCA.....	0522, 0822, 0060
Samsung.....	0744, 0820, 1044, 1075
Sansui.....	0695, 1695
Sanyo.....	0873, 0104
Sharp.....	0630, 0848
Sony.....	0864, 1431

Sylvania.....	0675, 0000, 0593, 1593
Symphonic.....	0675, 0000, 1593
Teac.....	0833, 1483
Toshiba.....	0503
Zenith.....	0741, 0869

CBL/DVR
Cable/DVR combination

Americast.....	0899
Digeo.....	1187
Freebox.....	1482
General Instrument.....	0476, 0810
Jerrold.....	0476, 0810
Motorola.....	0476, 0810, 1106, 1187, 1376
Nokia.....	1569
Noos.....	1624
Pace.....	0237, 1877
Pioneer.....	0877, 1877
RCA.....	1256
Scientific Atlanta.....	0877, 1877
Sony.....	1006
Supercable.....	0276
Thomson.....	1256
Zenith.....	0899

SAT/DVR
Satellite/DVR combination

@sat.....	1300
Amino.....	1615
Atsat.....	1300
British Sky Broadcasting.....	1175
Canal Satellite.....	1339
Comag.....	1412
Digiturk.....	1076
DirecTV.....	0099, 0392, 0639, 1076, 1142, 1377, 1392, 1442, 1443, 1444, 1640
Dish Network System....	0775, 1505
Dishpro.....	0775, 1505
Dream Multimedia.....	1237
Echostar.....	0610, 0775, 1170, 1505
Expressvu.....	0775
Foxtel.....	1356
GbSAT.....	1214
Grundig.....	1150

Hughes Network.....	1142, 1442, 1443, 1444
Systems	
Humax.....	1176, 1427, 1568, 1670, 1675
Hyundai.....	1159
JVC.....	1170
Kathrein.....	1221, 1561
Maximum.....	1334
Motorola.....	0869
Nokia.....	1311
Opentel.....	1412
Pace.....	1423, 1623
Panasonic.....	1320
Philips.....	0099, 1142, 1442
Proscan.....	0392
RCA.....	1392
Rebox.....	1214
Sagem.....	1253, 1307
Samsung.....	1442
Sharp.....	1489
Siemens.....	1657
SKY.....	1175, 1848
Skyplus.....	1412
Sony.....	0639, 1640
Star Choice.....	0869
Strong.....	1300
Thomson.....	1900
Topfield.....	1206, 1545
TPS.....	1253, 1307
Zehnder.....	1075, 1412

DVD/DVR
DVD/DVR combination

Go Video.....	1730
Mustek.....	1730
Panasonic.....	1807, 0490, 1010, 1011
Philips.....	1340, 0539, 1158, 1818
Pioneer.....	1337, 0631, 1816
RCA.....	0880, 0522
Sharp.....	1256
Tivo.....	1337, 1816
Toshiba.....	1008, 1503



289772-001

BOSE[®]
Better sound through research[®]

©2005 Bose Corporation, The Mountain,
Framingham, MA 01701-9168 USA
289772 AM Rev.00 CCM-001770